

# CITOLINE i250 & i300

## OPERATOR'S MANUAL



ENGLISH



**THANK YOU!** For choosing the QUALITY of the Lincoln Electric products.

- Please check packaging and equipment for damage. Claims for material damaged in shipment must be notified immediately to the dealer.
- For ease of use, please enter your product identification data in the table below. Model Name, Code & Serial Number can be found on the machine rating plate.

Model Name:	
Code & Serial number:	
Date & Where Purchased:	

## ENGLISH INDEX

Technical Specifications .....	1
ECO design information .....	3
Electromagnetic Compatibility (EMC) .....	5
Safety .....	6
Introduction .....	8
Installation and Operator Instructions .....	8
WEEE .....	18
Spare Parts .....	18
Authorized Service Shops Location .....	18
Electrical Schematic .....	18
Accessories .....	19
Dimension Diagram .....	20

# Technical Specifications

NAME		INDEX			
CITOLINE i250		W100000317			
CITOLINE i300		W100000318			
INPUT					
	Input Voltage U <sub>1</sub>	EMC Class		Frequency	
CITOLINE i250	400V ± 10%, 3-phase	A		50/60Hz	
CITOLINE i300					
	Process	Input Power at Rated Cycle (40°C)	Input Amperes I <sub>1max</sub>	PF	
CITOLINE i250	GMAW/FCAW	12,8 kVA @ 35% Duty Cycle	18,2 A	0,61	
	SMAW	14 kVA @ 35% Duty Cycle	19,8 A	0,62	
CITOLINE i300	GMAW/FCAW	15 kVA @ 35% Duty Cycle	22,0 A	0,65	
	SMAW	14 kVA @ 35% Duty Cycle	19,8 A	0,62	
RATED OUTPUT					
	Process	Open Circuit Voltage	Duty Cycle 40°C (based on a 10 min. period)	Output Current	Output Voltage
CITOLINE i250	GMAW	72Vdc	35%	250A	26,5Vdc
			60%	230A	25,5Vdc
			100%	175A	22,8Vdc
	FCAW		35%	250A	26,5Vdc
			60%	230A	25,5Vdc
			100%	175A	22,8Vdc
	SMAW		35%	250A	30Vdc
			60%	190A	27,6Vdc
			100%	150A	26Vdc
CITOLINE i300	GMAW	72Vdc	35%	300A	29Vdc
			60%	230A	25,5Vdc
			100%	175A	22,8Vdc
	FCAW		35%	300A	29Vdc
			60%	230A	25,5Vdc
			100%	175A	22,8Vdc
	SMAW		35%	250A	30Vdc
			60%	190A	27,6Vdc
			100%	150A	26Vdc
WELDING CURRENT RANGE					
	GMAW	FCAW	SMAW		
CITOLINE i250	50A÷250A	50A÷250A	10A÷250A		
CITOLINE i300	50A÷300A	50A÷300A	10A÷250A		
RECOMMENDED INPUT CABLE AND FUSE SIZES					
	Fuse Type gR or Circuit Breaker Type D		Power Lead		
CITOLINE i250	16A, 400V AC		4 Conductor, 2,5mm <sup>2</sup>		
CITOLINE i300	16A, 400V AC		4 Conductor, 2,5mm <sup>2</sup>		

<b>WELDING VOLTAGE REGULATION RANGE</b>				
	GMAW		FCAW	
<b>CITOLINE i250</b>	16,5 V ÷ 26,5 V		16,5 V ÷ 26,5 V	
<b>CITOLINE i300</b>	16,5 V ÷ 29 V		16,5 V ÷ 29 V	
<b>WIRE FEED SPEED RANGE / WIRE DIAMETER</b>				
	WFS Range	Drive Rolls	Drive roll diameter	
<b>CITOLINE i250</b>	1.5 ÷ 18m/min	4	Ø30	
<b>CITOLINE i300</b>				
	Solid Wires	Aluminum Wires	Cored Wires	
<b>CITOLINE i250</b>	0.6 ÷ 1.2 mm	1.0 ÷ 1.2 mm	0.8 ÷ 1.0 mm	
<b>CITOLINE i300</b>				
<b>DIMENSION</b>				
	Weight	Height	Width	Length
<b>CITOLINE i250</b>	50 kg	760 mm	395 mm	830 mm
<b>CITOLINE i300</b>	50 kg			
<b>OTHERS</b>				
	Protection Rating	Maximum Gas Pressure	Operating Humidity (t=20°C)	
<b>CITOLINE i250</b>	IP23	0,5MPa (5 bar)	≤ 90 %	
<b>CITOLINE i300</b>				
	Operating Temperature	Storage Temperature		
<b>CITOLINE i250</b>	from -10°C to +40°C	from -25°C to 55°C		
<b>CITOLINE i300</b>				

# ECO design information

The equipment has been designed in order to be compliant with the Directive 2009/125/EC and the Regulation 2019/1784/EU.

Efficiency and idle power consumption:

Index	Name	Efficiency when max power consumption / Idle power consumption	Equivalent model
W100000317	CITOLINE i250	86% / 23W	No equivalent model
W100000318	CITOLINE i300	86% / 23W	No equivalent model

Idle state occurs under the condition specified in below table

IDLE STATE	
Condition	Presence
MIG mode	X
TIG mode	
STICK mode	
After 30 minutes of non-working	
Fan off	X

The value of efficiency and consumption in idle state have been measured by method and conditions defined in the product standard EN 60974-1:20XX.

Manufacturer's name, product name, code number, product number, serial number and date of production can be read from rating plate.

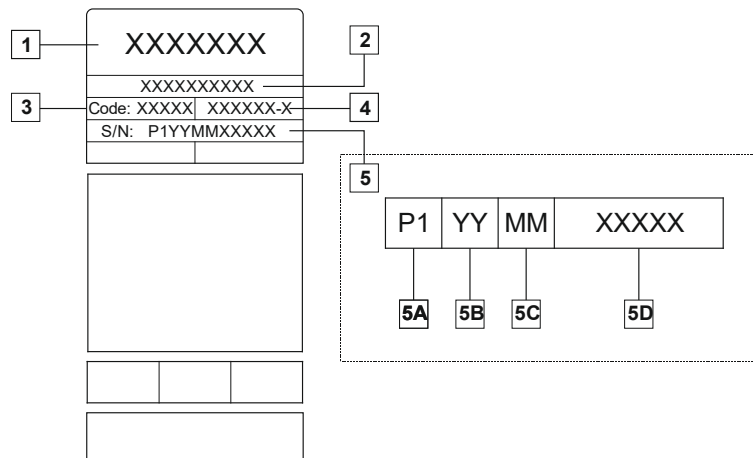

Where:

- 1-Manufacturer name and address
- 2-Product name
- 3-Code number
- 4-Product number
- 5-Serial number
  - 5A- country of production
  - 5B- year of production
  - 5C- month of production
  - 5D- progressive number different for each machine

Typical gas usage for **MIG/MAG** equipment:

Material type	Wire diameter [mm]	DC electrode positive		Wire Feeding [m/min]	Shielding Gas	Gas flow [l/min]
		Current [A]	Voltage [V]			
Carbon, low alloy steel	0,9 ÷ 1,1	95 ÷ 200	18 ÷ 22	3,5 – 6,5	Ar 75%, CO <sub>2</sub> 25%	12
Aluminium	0,8 ÷ 1,6	90 ÷ 240	18 ÷ 26	5,5 – 9,5	Argon	14 ÷ 19
Austenitic stainless steel	0,8 ÷ 1,6	85 ÷ 300	21 ÷ 28	3 - 7	Ar 98%, O <sub>2</sub> 2% / He 90%, Ar 7,5% CO <sub>2</sub> 2,5%	14 ÷ 16
Copper alloy	0,9 ÷ 1,6	175 ÷ 385	23 ÷ 26	6 - 11	Argon	12 ÷ 16
Magnesium	1,6 ÷ 2,4	70 ÷ 335	16 ÷ 26	4 - 15	Argon	24 ÷ 28

**TIG Process:**

In TIG welding process, gas usage depends on cross-sectional area of the nozzle. For commonly used torches:

Helium: 14-24 l/min

Argon: 7-16 l/min

**Notice:** Excessive flow rates causes turbulence in the gas stream which may aspirate atmospheric contamination into the welding pool.

**Notice:** A cross wind or draft moving can disrupt the shielding gas coverage, in the interest of saving of protective gas use screen to block air flow.



**End of life**

At end of life of product, it has to be disposal for recycling in accordance with Directive 2012/19/EU (WEEE), information about the dismantling of product and Critical Raw Material (CRM) present in the product, can be found at <https://www.lincolnelectric.com/en-gb/support/Pages/operator-manuals-eu.aspx>

# Electromagnetic Compatibility (EMC)

11/04

This machine has been designed in accordance with all relevant directives and standards. However, it may still generate electromagnetic disturbances that can affect other systems like telecommunications (telephone, radio, and television) or other safety systems. These disturbances can cause safety problems in the affected systems. Read and understand this section to eliminate or reduce the amount of electromagnetic disturbance generated by this machine.



This machine has been designed to operate in an industrial area. To operate in a domestic area it is necessary to observe particular precautions to eliminate possible electromagnetic disturbances. The operator must install and operate this equipment as described in this manual. If any electromagnetic disturbances are detected the operator must put in place corrective actions to eliminate these disturbances, if necessary with assistance from

Lincoln Electric.

## **WARNING**

Provided that the public low voltage system impedance at the point of common coupling is lower than:

- 58 mΩ for the **CITOLINE i250**
- 59,9 mΩ for the **CITOLINE i300**

This equipment is compliant with IEC 61000-3-11 and IEC 61000-3-12 and can be connected to public low voltage systems. It is the responsibility of the installer or user of the equipment to ensure, by consultation with the distribution network operator if necessary, that the system impedance complies with the impedance restrictions.

Before installing the machine, the operator must check the work area for any devices that may malfunction because of electromagnetic disturbances. Consider the following.

- Input and output cables, control cables, and telephone cables that are in or adjacent to the work area and the machine.
- Radio and/or television transmitters and receivers. Computers or computer controlled equipment.
- Safety and control equipment for industrial processes. Equipment for calibration and measurement.
- Personal medical devices like pacemakers and hearing aids.
- Check the electromagnetic immunity for equipment operating in or near the work area. The operator must be sure that all equipment in the area is compatible. This may require additional protection measures.
- The dimensions of the work area to consider will depend on the construction of the area and other activities that are taking place.

Consider the following guidelines to reduce electromagnetic emissions from the machine.

- Connect the machine to the input supply according to this manual. If disturbances occur it may be necessary to take additional precautions such as filtering the input supply.
- The output cables should be as short as possible and positioned together as close as possible to each other. If possible connect the work piece to ground in order to reduce the electromagnetic emissions. The operator must check that connecting the work piece to ground does not cause problems or unsafe operating conditions for personnel and equipment.
- Shielding of cables in the work area can reduce electromagnetic emissions. This may be necessary for special applications.

## **WARNING**

EMC classification of this product is class A in accordance with electromagnetic compatibility standard EN 60974-10 which means that the product is designed to be used in an industrial environment only.

## **WARNING**

The Class A equipment is not intended for use in residential locations where the electrical power is provided by the public low-voltage supply system. There may be potential difficulties in ensuring electromagnetic compatibility in those locations, due to conducted as well as radiated disturbances.









## WARNING

This equipment must be used by qualified personnel. Be sure that all installation, operation, maintenance and repair procedures are performed only by qualified person. Read and understand this manual before operating this equipment. Failure to follow the instructions in this manual could cause serious personal injury, loss of life, or damage to this equipment. Read and understand the following explanations of the warning symbols. Lincoln Electric is not responsible for damages caused by improper installation, improper care or abnormal operation.

	<p><b>WARNING:</b> This symbol indicates that instructions must be followed to avoid serious personal injury, loss of life, or damage to this equipment. Protect yourself and others from possible serious injury or death.</p>
	<p><b>READ AND UNDERSTAND INSTRUCTIONS:</b> Read and understand this manual before operating this equipment. Arc welding can be hazardous. Failure to follow the instructions in this manual could cause serious personal injury, loss of life, or damage to this equipment.</p>
	<p><b>ELECTRIC SHOCK CAN KILL:</b> Welding equipment generates high voltages. Do not touch the electrode, work clamp, or connected work pieces when this equipment is on. Insulate yourself from the electrode, work clamp and connected work pieces.</p>
	<p><b>ELECTRICALLY POWERED EQUIPMENT:</b> Turn off input power using the disconnect switch at the fuse box before working on this equipment. Ground this equipment in accordance with local electrical regulations.</p>
	<p><b>ELECTRICALLY POWERED EQUIPMENT:</b> Regularly inspect the input, electrode, and work clamp cables. If any insulation damage exists replace the cable immediately. Do not place the electrode holder directly on the welding table or any other surface in contact with the work clamp to avoid the risk of accidental arc ignition.</p>
	<p><b>ELECTRIC AND MAGNETIC FIELDS MAY BE DANGEROUS:</b> Electric current flowing through any conductor creates electric and magnetic fields (EMF). EMF fields may interfere with some pacemakers and welders having a pacemaker shall consult their physician before operating this equipment.</p>
	<p><b>CE COMPLIANCE:</b> This equipment complies with the European Community Directives.</p>
<p><small>Optical radiation-emission Category 2 (EN 60825)</small></p>	<p><b>ARTIFICIAL OPTICAL RADIATION:</b> According with the requirements in 2006/25/EC Directive and EN 12198 Standard, the equipment is a category 2. It makes mandatory the adoption of Personal Protective Equipment (PPE) having filter with a protection degree up to a maximum of 15, as required by EN169 Standard.</p>
	<p><b>FUMES AND GASES CAN BE DANGEROUS:</b> Welding may produce fumes and gases hazardous to health. Avoid breathing these fumes and gases. To avoid these dangers the operator must use enough ventilation or exhaust to keep fumes and gases away from the breathing zone.</p>
	<p><b>ARC RAYS CAN BURN:</b> Use a shield with the proper filter and cover plates to protect your eyes from sparks and the rays of the arc when welding or observing. Use suitable clothing made from durable flame-resistant material to protect you skin and that of your helpers. Protect other nearby personnel with suitable, non-flammable screening and warn them not to watch the arc nor expose themselves to the arc.</p>

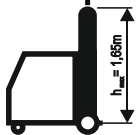

	<p><b>WELDING SPARKS CAN CAUSE FIRE OR EXPLOSION:</b> Remove fire hazards from the welding area and have a fire extinguisher readily available. Welding sparks and hot materials from the welding process can easily go through small cracks and openings to adjacent areas. Do not weld on any tanks, drums, containers, or material until the proper steps have been taken to insure that no flammable or toxic vapors will be present. Never operate this equipment when flammable gases, vapors or liquid combustibles are present.</p>
	<p><b>WELDED MATERIALS CAN BURN:</b> Welding generates a large amount of heat. Hot surfaces and materials in work area can cause serious burns. Use gloves and pliers when touching or moving materials in the work area.</p>
	<p><b>CYLINDER MAY EXPLODE IF DAMAGED:</b> Use only compressed gas cylinders containing the correct shielding gas for the process used and properly operating regulators designed for the gas and pressure used. Always keep cylinders in an upright position securely chained to a fixed support. Do not move or transport gas cylinders with the protection cap removed. Do not allow the electrode, electrode holder, work clamp or any other electrically live part to touch a gas cylinder. Gas cylinders must be located away from areas where they may be subjected to physical damage or the welding process including sparks and heat sources.</p>
	<p>A GAS CYLINDER can be used with this machine. In this case, place the gas cylinder on the back of the machine on the shelf intended for this and secure it by attaching it to the machine with chains. <b>The height of the cylinder cannot exceed 1.65m.</b></p>
	<p><b>MOVING PARTS ARE DANGEROUS:</b> There are moving mechanical parts in this machine, which can cause serious injury. Keep your hands, body and clothing away from those parts during machine starting, operating and servicing.</p>
	<p><b>SAFETY MARK:</b> This equipment is suitable for supplying power for welding operations carried out in an environment with increased hazard of electric shock.</p>

The manufacturer reserves the right to make changes and/or improvements in design without upgrade at the same time the operator's manual.

# Introduction

The welding machines **CITOLINE i250** and **CITOLINE i300** can be used for welding in below methods:

- GMAW
- FCAW
- SMAW

The complete package contains:

- Work lead with ground clamp – 3m,
- Gas hose – 2m,
- Drive roll V0.8/1.0 for solid wire (assembly in the wire feeder).

Recommended equipment, which can be bought by user, was mentioned in the chapter "Accessories".

# Installation and Operator Instructions

Read this entire section before installation or operation of the machine.

## Location and Environment

This machine will operate in harsh environments. However, it is important that simple preventative measures are followed to assure long life and reliable operation.

- Do not place or operate this machine on a surface with an incline greater than 10° from horizontal.
- Do not use this machine for pipe thawing.
- This machine must be located where there is free circulation of clean air without restrictions for air movement to and from the air vents. Do not cover the machine with paper, cloth or rags when switched on.
- Dirt and dust that can be drawn into the machine should be kept to a minimum.
- This machine has a protection rating of IP23. Keep it dry when possible and do not place it on wet ground or in puddles.
- Locate the machine away from radio controlled machinery. Normal operation may adversely affect the operation of nearby radio controlled machinery, which may result in injury or equipment damage. Read the section on electromagnetic compatibility in this manual.
- Do not operate in areas with an ambient temperature greater than 40°C.

## Duty cycle and Overheating

The duty cycle of a welding machine is the percentage of time in a 10 minute cycle at which the welder can operate the machine at rated welding current.

Example: 60% duty cycle

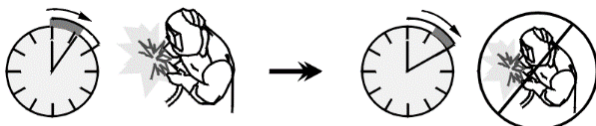

Cutting for 6 minutes.

Break for 4 minutes.

Excessive extension of the duty cycle will cause the thermal protection circuit to activate.

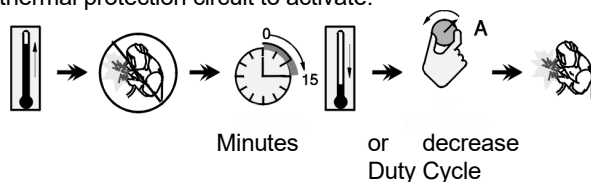

## Input Supply Connection

### WARNING

Only a qualified electrician can connect the welding machine to the supply network. Installation had to be made in accordance with the appropriate National Electrical Code and local regulations.

Check the input voltage, phase and frequency supplied to this machine before turning it on. Verify the connection of ground wires from the machine to the input source. The welding machine **CITOLINE i250**, **CITOLINE i300**, must be connected to a correctly installed plug-in socket with an earth pin.

Input voltage is three-phase 400VAC, 50/60Hz. For more information about input supply refer to the technical specification section of this manual and to the rating plate of the machine.

Make sure that the amount of mains power available from the input supply is adequate for normal operation of the machine. The necessary delayed fuse (or circuit breaker with "D" characteristic) and cable sizes are indicated in the technical specification section of this manual.

### WARNING

The welding machine can be supplied from a power generator of output power at least 30% larger than input power of the welding machine.

### WARNING

When powering welder from a generator be sure to turn off welder first, before generator is shut down, in order to prevent damage to welder!

## Output Connections

Refer to points [1], [3] and [4] of the figures below.

## Controls and Operational Features

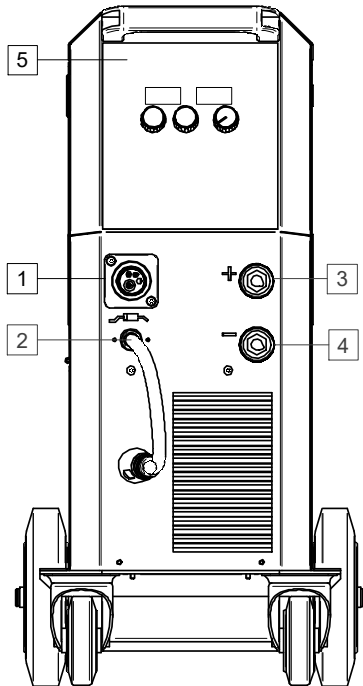

Figure 1

1. EURO Socket: For connecting a welding gun (for GMAW / FCAW processes).
2. Lead of Changing Polarity of EURO socket.
3. Positive Output Socket for the Welding Circuit: For connecting an electrode holder with lead / work lead depending on the require configuration. **+**
4. Negative Output Socket for the Welding Circuit: For connecting an electrode holder with lead / work lead depending on the require configuration. **-**
5. User Interface: See "User Interface" chapter.

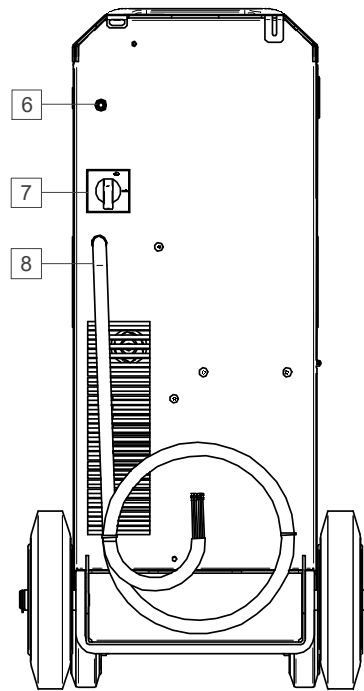

Figure 2

6. Gas Connector: Connection for gas line.
7. Power Switch ON/OFF (I/O): Controls the input power to the machine. Be sure the power source is connected to the mains supply before turning power on ("I").
8. Power Lead (3,4m): Connect the supply plug to the existing input cable that is rated for the machine as indicated in this manual, and conforms to all applicable standards. This connection shall be performed by a qualified person only.

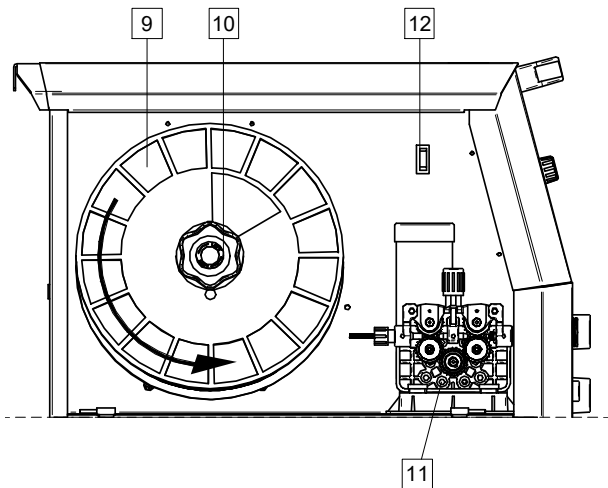

Figure 3

9. Spooled Wire (for GMAW / FCAW): Not supplied as standard.
10. Wire Spool Holder: Maximum 15kg spools. Maximum 300mm diameter spools. Holder allows mounting plastic, steel and fiber spools onto 51 mm spindle.  
**Note:** Plastic Brake Nut has a Left-hand thread.
11. Wire drive: 4-rolls wire drive.
12. Switch: Cold Inch / Gas Purge: This switch allows wire feeding (wire test) and gas flow (gas test) without switching on the output voltage.

## User Interface

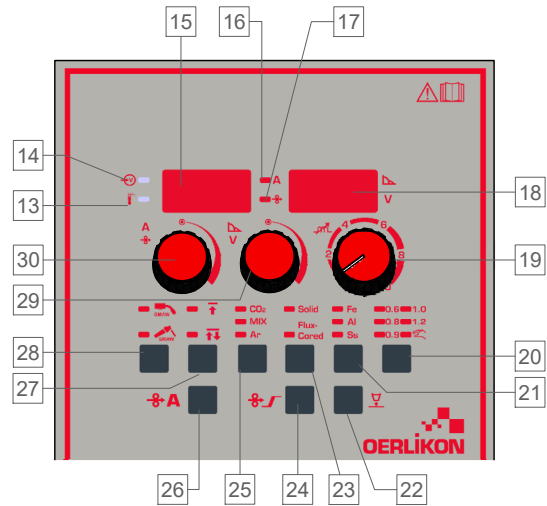





Figure 4

13. Thermal Overload Indicator: It indicates that the machine is overloaded or that the cooling is not sufficient. Displays show: "ALA ot" = Alarm Over Temperature message.
14. Input Power Indicator: This LED lights up when the welding machine is ON and is ready to work.
15. Left Display: Shows wire feed speed or welding current. During welding shows the actual welding current value.
16. Output Current LED Indicator: Informs that the Left Display shows the output current in ampere.
17. Wire Feed Speed LED Indicator: Informs that the Left Display shows the wire feed speed in m/min.
18. Right Display: Depending on the selected function and the welding program shows the welding voltage in volts or value of Arc Force. During welding shows the actual output welding voltage.
19. Inductance Control: Adjusts the hardness of the arc. A low value (1-4) makes the arc harder (more spatter), while a high value (8-10) produces a softer arc (less spatter). Adjustment range: 0 to +10.



20. **Wire Diameter or Manual Mode Selection Button:** Sets the diameter of the welding wire for Synergic Mode or choose Manual Mode.

Process	Symbol	Description
	0.6	Available wire diameter depends on choosing gas shielding type, type of wire and welding wire material.
	0.8	
	0.9	
	1.0	
	1.2	The machine works in Manual mode. Welding parameters (wire feed speed and voltage) are selected by the user.
		

21. **Wire Material Selection Button:** sets the type of wire materials (for Synergic Mode only):

Process	Symbol	Description
	Fe	Steel
	Al	Aluminum
	SS	Stainless steel



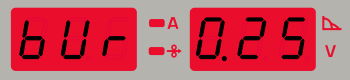

22. **Burnback Time Selection Button** – for Synergic and Manual Mode, allow to choose and set burnback time:

Process	Symbol	Description
		Burnback Time - amount of time that the welding is continued after the wire stops feeding. It prevents the wire from sticking in the puddle and prepares the end of the wire for the next arc ignition.
		<ul style="list-style-type: none"> <li>Regulation range: from 0,02 to 0,25 seconds.</li> </ul>
		 

23. **Welding Wire Type Selection Button:** Set welding wire type (for Synergic Mode only):

Process	Symbol	Description
	Solid	<ul style="list-style-type: none"> <li>For Synergic Mode only</li> <li>Gas shield required</li> </ul>
	Flux-Cored	



24. **Run-In WFS Button:** Allow to show and set the Run-in wire feed speed value (for Synergic and Manual Mode):

Process	Symbol	Description
		Run-in WFS – sets the wire feed speed from the time the trigger is pulled until an arc is established.
		<ul style="list-style-type: none"> <li>Adjust range: from 20 to 100 percent of the WFS value.</li> <li>When Run-In value is more than max WFS, machine keep max WFS.</li> </ul>
		 



25. **Gas Selection Button:** Enables the selection of the type of shielding gas (for Synergic Mode only).

Process	Symbol	Description
	CO <sub>2</sub>	To choose gas shielding.
	MIX	
	Ar	

26. **Selection Button to Display Workpoint as WFS or A:** Allows to change the operating point display as wire feed speed (WFS) in [m/min] or as an output current value in [A]. Only available in synergic mode.

Process	Symbol	Description
		Workpoint values are displayed in m/min.
	A	Workpoint values are displayed as an amperage [A].

27. Torch Trigger Mode Button (2-Step/4-Step): Change the function of the torch trigger.

Process	Symbol	Description
 GMAW		<b>2-Step</b> trigger operation turns welding on and off as direct response to the trigger. Welding process starts when the torch trigger is press.
		<b>4-Step</b> mode allows to continue welding, when the torch trigger is released. To stop welding, the torch trigger should be pressed again. 4-step model facilitates to make long welds.

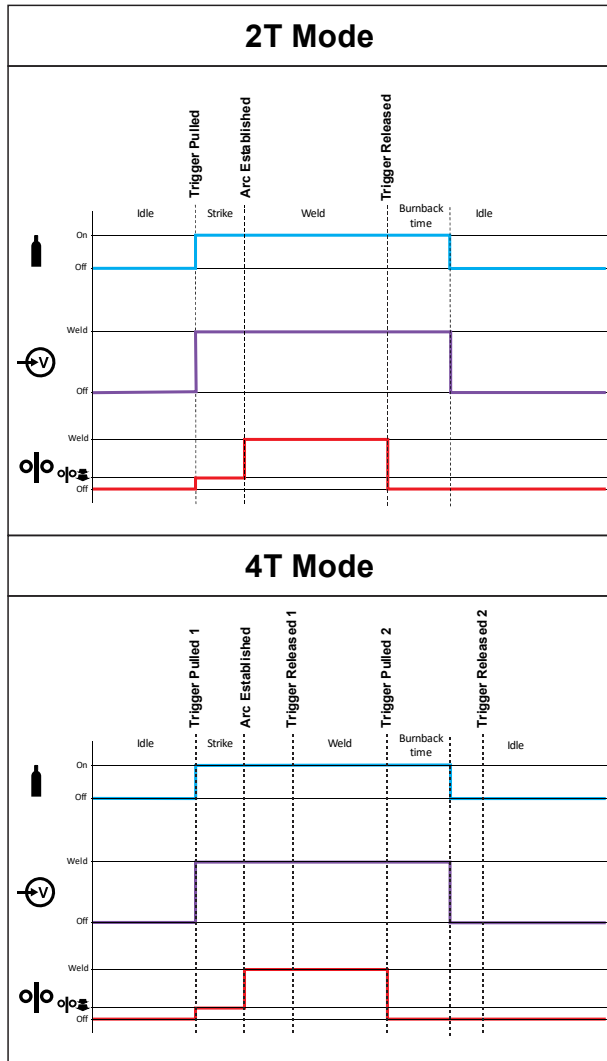











Figure 5





28. Welding Process Selection Button: Allow to choose the welding process:

Symbol	Description
 GMAW	GMAW/FACW welding mode.
 SMAW	SMAW welding mode.

29. The Center Control: Sets the value shown on the right display. Depending on welding processes or selected function can be set:

Process	Symbol	Description
 GMAW		The welding voltage (also during welding).
 GMAW		Burnback Time • Adjust range: from 0.02 to 0.25 seconds
 GMAW		Run-in WFS • Adjust range: from 20 to 100 percent of the WFS value.
 SMAW		ARC FORCE, the output current is temporarily increased to clear short circuit connections between the electrode and the workpiece. Lower values will provide less short circuit current and a softer arc. Higher settings will provide a higher short circuit current, a more forceful arc and possibly more spatter. • Adjust range: from 0 to 100.

30. Left Control: Sets the value shown on the left display. Depending on welding process can be set:

Process	Mark	Description
 GMAW		Workpoint values are displayed in m/min.
 SMAW		Workpoint values are displayed as an amperage [A].

## Welding SMAW Process

**CITOLINE i250, CITOLINE i300** does not include the electrode holder with lead necessary for SMAW welding, but the one can be purchased separately.

Procedure of begin welding of SMAW process:

- First turn the machine off.
- Determine the electrode polarity for the electrode to be used. Consult the electrode data for this information.
- Depending on the polarity of using electrode, connect the work lead and the electrode holder with lead to output socket [3] or [4] and lock them. See the Table 1.

**Table 1.**

		Output socket	
POLARITY	DC (+)	The electrode holder with lead to SMAW	[3] <b>+</b>
		Work lead	[4] <b>-</b>
	DC (-)	The electrode holder with lead to SMAW	[3] <b>-</b>
		Work lead	[4] <b>+</b>

- Connect the work lead to the welding piece with the work clamp.
- Install the proper electrode in the electrode holder.
- Turn the welding machine on.
- Set welding mode to SMAW.
- Set the welding parameters.
- The welding machine is now ready to weld.
- By applying the principle of occupational health and safety at welding, welding can be begun.

User can set functions:

- The welding current
- Arc dynamics ARC FORCE

## Welding GMAW, FCAW Process

**CITOLINE i250, CITOLINE i300** can be used to welding GMAW, FCAW-GS, FCAW-SS process.

**NOTE:** Welding FCAW-SS process is possible in Manual Mode only.

In **CITOLINE i250, CITOLINE i300** can be set:

- Wire Feed Speed, WFS
- The welding voltage
- Burnback Time
- Run-in WFS
- 2-Step/4-Step
- Polarization DC+/DC-
- Inductance

## Preparation the Machine for Welding GMAW and FCAW Process.

Procedure of welding in GMAW or FCAW process:

- Determine the wire polarity for the wire to be used. Consult the wire data for this information.
- Connect output the gas-cooled gun to GMAW / FCAW process to Euro Socket [1].
- Depending on the using wire, connect the work lead to output socket [3] or [4]. See the Table 2.

**Table 2**

		Output socket	
POLARITY	DC (+)	Lead of Changing Polarity [2]	[3] <b>+</b>
		Work lead	[4] <b>-</b>
	DC (-)	Lead of Changing Polarity [2]	[3] <b>-</b>
		Work lead	[4] <b>+</b>



- Connect the work lead to the welding piece with the work clamp.
- Install the proper wire.
- Install the proper drive roll.
- Make sure, if it is needed (GMAW, FCAW-GS processes), that the gas shield has been connected.
- Turn the machine on.
- Push the Cold Inch Switch [12] to feed the wire through the gun liner until the wire comes out of the threaded end.
- Install a proper contact tip.
- Check gas flow with Gas Purge Switch [12] – GMAW and FCAW processes.
- Close the left side panel.
- Set welding mode to GMAW
- The welding machine is now ready to weld.
- By applying the principle of occupational health and safety at welding, welding can be begun.

## Welding GMAW Process in synergic mode

In synergic mode, the welding load voltage is not set by user. The correct welding load voltage will set by the machine's software.

The optimum output welding voltage is automatically set by the machine when changing the wire feed speed m/min or the output current value in A, depending on the selected workpoint. Table 3 below show all available synergic welding programs.

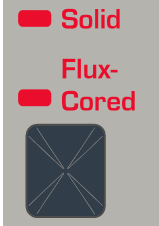
Table 3

Wire Diameter	Wire type	Wire Material	Gas Type
			
0.6	Solid	Fe	CO <sub>2</sub>
0.8	Solid	Fe	CO <sub>2</sub>
0.9	Solid	Fe	CO <sub>2</sub>
1.0	Solid	Fe	CO <sub>2</sub>
1.2	Solid	Fe	CO <sub>2</sub>
0.6	Solid	Fe	MIX
0.8	Solid	Fe	MIX
0.9	Solid	Fe	MIX
1.0	Solid	Fe	MIX
1.2	Solid	Fe	MIX
0.8	Solid	Ss	MIX
0.9	Solid	Ss	MIX
1.0	Solid	Ss	MIX
1.2	Solid	Ss	MIX
0.8	Flux-Cored	Fe	CO <sub>2</sub>
0.9	Flux-Cored	Fe	CO <sub>2</sub>
1.0	Flux-Cored	Fe	CO <sub>2</sub>
1.2	Flux-Cored	Fe	CO <sub>2</sub>
0.8	Flux-Cored	Fe	MIX
0.9	Flux-Cored	Fe	MIX
1.0	Flux-Cored	Fe	MIX
1.2	Flux-Cored	Fe	MIX
1.0	Solid	Al	Ar
1.2	Solid	Al	Ar



## Loading the Electrode Wire

Depending on the type of wire spool it can be installed on the wire spool support without adapter or installed with use applicable adapter that must be purchased separately (see "Accessories" chapter).

### **WARNING**

Turn the input power OFF at the welding power source before installation or changing a wire spool.

- Turn the machine off.
- Open the side cover of the machine.
- Unscrew the locking nut of the sleeve.
- Load the spool with the wire on the sleeve such that the spool turns anticlockwise when the wire is fed into the wire feeder.
- Make sure that the spool locating pin goes into the fitting hole on the spool.
- Screw in the fastening cap of the sleeve.
- Put on the wire roll using the correct groove corresponding to the wire diameter.
- Free the end of the wire and cut off the bent end making sure it has no burr.
- The device is adapted to the spool max. 300mm

### **WARNING**

Sharp end of the wire can hurt.

- Rotate the wire spool anticlockwise and thread the end of the wire into the wire feeder as far as the Euro socket.
- Adjust force of pressure roll of the wire feeder properly.

## Adjustments of Brake Torque of Sleeve

To avoid spontaneous unrolling of the welding wire the sleeve is fitted with a brake.

Adjustment is carried by rotation of its Allen screw M8, which is placed inside of the sleeve frame after unscrewing the fastening cap of the sleeve.

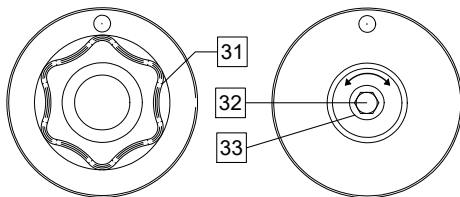

Figure 6

- 31. Fastening cap.
- 32. Adjusting Allen screw M8.
- 33. Pressing spring.

Turning the Allen screw M8 anticlockwise increases the spring tension and you can increase the brake torque

Turning the Allen screw M8 clockwise decreases the spring tension and you can decrease the brake torque.

After finishing of adjustment, you should screw in the fastening cap again.

## Adjusting of Force of Pressure Roll Force

The pressure arm controls the amount of force the drive rolls exert on the wire.

Pressure force is adjusted by turning the adjustment nut clockwise to increase force, counterclockwise to decrease force. Proper adjustment of pressure arm gives the best welding performance.

### **WARNING**

If the roll pressure is too low the roll will slide on the wire. If the roll pressure is set too high the wire may be deformed, which will cause feeding problems in the welding gun. The pressure force should be set properly. Decrease the pressure force slowly until the wire just begins to slide on the drive roll and then increase the force slightly by turning of the adjustment nut by one turn.

## Inserting Electrode Wire into Welding Torch

- Turn the welding machine off.
- Depending on welding process, connect the proper gun to the euro socket, the rated parameters of the gun and of the welding machine should be matched.
- Remote the nozzle from the gun and contact tip or protection cap and contact tip. Next, straighten the gun out flat.
- Turn the welding machine on.
- Push the Cold Inch Switch [12] to feed the wire through the gun liner until the wire comes out of the threaded end.
- When switch is released spool of wire should not unwind.
- Adjust wire spool brake accordingly.
- Turn the welding machine off.
- Install a proper contact tip.
- Depending on the welding process and the type of the gun, install the nozzle (GMAW process) or protection cap (FCAW- process).

### **WARNING**

Take precaution to keep eyes and hands away from the end of the gun while the wire is being come out of the threaded end.

## Changing Driving Rolls

### WARNING

Turn the input power off of the welding power source before installation or changing drive rolls.

**CITOLINE i250, CITOLINE i300** is equipped with drive roll V0.8/V1.0 for steel wire. For others wire type or / and diameter, the proper drive rolls kit you can find in "Accessories" chapter and follow instructions:

- Turn the input power OFF.
- Unlock 2 rolls by turning 2 Quick-Change Carrier Gear [38].
- Release the pressure roll levers [39].
- Change the drive rolls [37] corresponding to the used wire.

### WARNING

Be sure that the gun liner and contact tip are also sized to match the selected wire size.

### WARNING

For wires with the diameter larger than 1.6mm, the following parts have to be changed:

- The guide tube of the feeding console [35] and [36].
- The guide tube of the Euro Socket [34].
- Lock 2 new rolls by turning 2 Quick-Change Carrier Gear [38].
- Insert the wire through the guide tube, over the roller and through the guide tube of Euro Socket into liner of gun. The wire can be pushed into the liner manually for a few centimeters, and should feed easily and without any force.
- Lock the pressure roll lever [39].

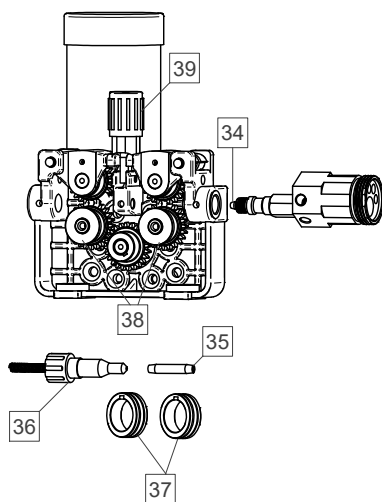

Figure 7

## Gas Connection

A gas cylinder must be installed with a proper flow regulator. Once a gas cylinder with a flow regulator has been securely installed, connect the gas hose from the regulator to the machine gas inlet connector.

### WARNING

The welding machine supports all suitable shielding gases including carbon dioxide, argon and helium at a maximum pressure of 5,0 bars.

## Transport & Lifting



### WARNING

Falling equipment can cause injury and damage to unit.

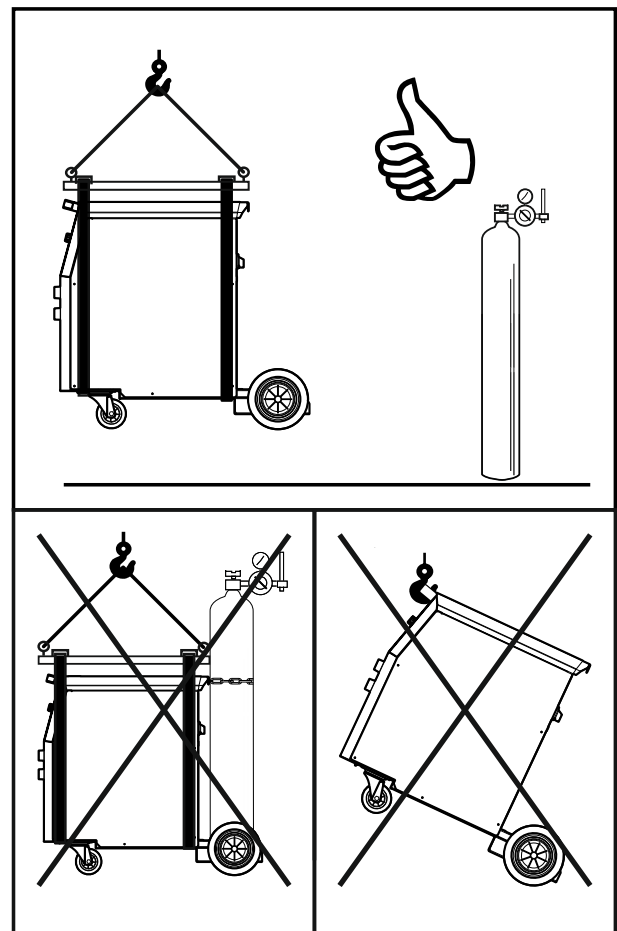

Figure 8

During transportation and lifting with a crane, adhere to the following rules:

- Power source does not include the eye bolt which can be used to transport or lifting the machine.
- To lift use of suitable lifting equipment capacity.
- To lifting and transport use a travers and minimum two belts.
- Lift only power source without gas cylinder, cooler and wire feeder, or/and any other accessories.

## Maintenance

### **WARNING**

For any repair operations, modifications or maintenances, it is recommended to contact the nearest Technical Service Center or Lincoln Electric. Repairs and modifications performed by unauthorized service or personnel will cause, that the manufacturer's warranty will become null and void.

Any noticeable damage should be reported immediately and repaired.

#### **Routine maintenance (everyday)**

- Check condition of insulation and connections of the work leads and insulation of power lead. If any insulation damage exists replace the lead immediately.
- Remove the spatters from the welding gun nozzle. Spatters could interfere with the shielding gas flow to the arc.
- Check the welding gun condition: replace it, if necessary.
- Check condition and operation of the cooling fan. Keep clean its airflow slots.

#### **Periodic maintenance (every 200 working hours but at list once every year)**

- Perform the routine maintenance and, in addition:
- Keep the machine clean. Using a dry (and low pressure) airflow, remove the dust from the external case and from the cabinet inside.
- If it is required, clean and tighten all weld terminals.

The frequency of the maintenance operations may vary in accordance with the working environment where the machine is placed.

### **WARNING**

Do not touch electrically live parts.

### **WARNING**

Before the case of welding machine will be removed, the welding machine had to be turned off and the power lead had to be disconnected from mains socket.

### **WARNING**

Mains supply network must be disconnected from the machine before each maintenance and service. After each repair, perform proper tests to ensure safety.

## Customer Assistance Policy

The business of The Lincoln Electric Company is manufacturing and selling high quality welding equipment, consumables, and cutting equipment. Our challenge is to meet the needs of our customers and to exceed their expectations. On occasion, purchasers may ask Lincoln Electric for advice or information about their use of our products. We respond to our customers based on the best information in our possession at that time. Lincoln Electric is not in a position to warrant or guarantee such advice, and assumes no liability, with respect to such information or advice. We expressly disclaim any warranty of any kind, including any warranty of fitness for any customer's particular purpose, with respect to such information or advice. As a matter of practical consideration, we also cannot assume any responsibility for updating or correcting any such information or advice once it has been given, nor does the provision of information or advice create, expand or alter any warranty with respect to the sale of our products.

Lincoln Electric is a responsive manufacturer, but the selection and use of specific products sold by Lincoln Electric is solely within the control of, and remains the sole responsibility of the customer. Many variables beyond the control of Lincoln Electric affect the results obtained in applying these types of fabrication methods and service requirements.

Subject to Change – This information is accurate to the best of our knowledge at the time of printing. Please refer to [www.oerlikon.com](http://www.oerlikon.com) for any updated information.

## WEEE

07/06



Do not dispose of electrical equipment together with normal waste!

In observance of European Directive 2012/19/EC on Waste Electrical and Electronic Equipment (WEEE) and its implementation in accordance with national law, electrical equipment that has reached the end of its life must be collected separately and returned to an environmentally compatible recycling facility. As the owner of the equipment, you should get information on approved collection systems from our local representative.

By applying this European Directive you will protect the environment and human health!

## Spare Parts

12/05

### Part List reading instructions

- Do not use this part list for a machine if its code number is not listed. Contact the Lincoln Electric Service Department for any code number not listed.
- Use the illustration of assembly page and the table below to determine where the part is located for your particular code machine.
- Use only the parts marked "X" in the column under the heading number called for in the assembly page (# indicate a change in this printing).

First, read the Part List reading instructions above, then refer to the "Spare Part" manual supplied with the machine that contains a picture-descriptive part number cross-reference.

## Authorized Service Shops Location

09/16

- The purchaser must contact Lincoln Electric or Authorized Service Facility about any defect claimed under warranty period.
- Contact your local Sales Representative for assistance in locating the nearest Authorized Service Facility.

## Electrical Schematic

Refer to the "Spare Part" manual supplied with the machine.

## Accessories

OPTIONS & ACCESSORIES	
E/H-300A-50-xM	Electrode holder 300A/50mm <sup>2</sup> , x=5 (5m) or x=10 (10m)
E/H-400A-70-xM	Electrode holder 400A/70mm <sup>2</sup> , x=5 (5m) or x=10 (10m)
K10158-1	Adapter for spool type S300
K10158	Adapter for spool 300mm
R-1019-125-1/08R	Adapter for spool 200mm
Roll Kit For Solid Wires	
KP69025-0608	SOLID DRIVE ROLL 0.6/0.8
KP69025-0809	SOLID DRIVE ROLL 0.8/0.9
KP69025-0810	SOLID DRIVE ROLL 0.8/1.0
KP69025-1012	SOLID DRIVE ROLL 1.0/1.2
KP69025-1216	SOLID DRIVE ROLL 1.2/1.6
Roll Kit For Aluminum Wires	
KP69025-0608A	ALUMINUM DRIVE ROLL 0.6/0.8
KP69025-0809A	ALUMINUM DRIVE ROLL 0.8/0.9
KP69025-1012A	ALUMINUM DRIVE ROLL 1.0/1.2
KP69025-0810A	ALUMINUM DRIVE ROLL 0.8/1.0
KP69025-1216A	ALUMINUM DRIVE ROLL 1.2/1.6
Roll Kit For Cored Wires	
KP69025-0608R	FLUX CORED DRIVE ROLL 0.6/0.8
KP69025-0809R	FLUX CORED DRIVE ROLL 0.8/0.9
KP69025-1012R	FLUX CORED DRIVE ROLL 1.0/1.2
KP69025-0810R	FLUX CORED DRIVE ROLL 0.8/1.0
KP69025-1216R	FLUX CORED DRIVE ROLL 1.2/1.6
MIG/MAG TORCHES	
W10429-24-3M	LGS2 240 G-3.0M MIG GUN AIR COOLED
W10429-24-4M	LGS2 240 G-4.0M MIG GUN AIR COOLED
W10429-24-5M	LGS2 240 G-5.0M MIG GUN AIR COOLED
W10429-25-3M	LGS2 250 G-3.0M MIG GUN AIR COOLED
W10429-25-4M	LGS2 250 G-4.0M MIG GUN AIR COOLED
W10429-25-5M	LGS2 250 G-5.0M MIG GUN AIR COOLED
W10429-36-3M	LGS2 360 G-3.0M MIG GUN AIR COOLED
W10429-36-4M	LGS2 360 G-4.0M MIG GUN AIR COOLED
W10429-36-5M	LGS2 360 G-5.0M MIG GUN AIR COOLED

# Dimension Diagram

