

Operator's Manual

VRTEX[®] 360, 360+, TRANSPORT, TRANSPORT+

For use with machines having Code Numbers:
12923, 12924, 12925 And 12926



Register your machine:
www.lincolnelectric.com/register

Authorized Service and Distributor Locator:
www.lincolnelectric.com/locator

Save for future reference

Date Purchased

Code: (ex: 10859)

Serial: (ex: U1060512345)



THANK YOU FOR SELECTING A QUALITY PRODUCT BY LINCOLN ELECTRIC.

PLEASE EXAMINE CARTON AND EQUIPMENT FOR DAMAGE IMMEDIATELY

When this equipment is shipped, title passes to the purchaser upon receipt by the carrier. Consequently, claims for material damaged in shipment must be made by the purchaser against the transportation company at the time the shipment is received.

SAFETY DEPENDS ON YOU

Lincoln arc welding and cutting equipment is designed and built with safety in mind. However, your overall safety can be increased by proper installation ... and thoughtful operation on your part. **DO NOT INSTALL, OPERATE OR REPAIR THIS EQUIPMENT WITHOUT READING THIS MANUAL AND THE SAFETY PRECAUTIONS CONTAINED THROUGHOUT.** And, most importantly, think before you act and be careful.

WARNING

This statement appears where the information must be followed exactly to avoid serious personal injury or loss of life.

CAUTION

This statement appears where the information must be followed to avoid minor personal injury or damage to this equipment.



KEEP YOUR HEAD OUT OF THE FUMES.

DON'T get too close to the arc. Use corrective lenses if necessary to stay a reasonable distance away from the arc.

READ and obey the Safety Data Sheet (SDS) and the warning label that appears on all containers of welding materials.

USE ENOUGH VENTILATION or exhaust at the arc, or both, to keep the fumes and gases from your breathing zone and the general area.

IN A LARGE ROOM OR OUTDOORS, natural ventilation may be adequate if you keep your head out of the fumes (See below).

USE NATURAL DRAFTS or fans to keep the fumes away from your face.

If you develop unusual symptoms, see your supervisor. Perhaps the welding atmosphere and ventilation system should be checked.



WEAR CORRECT EYE, EAR & BODY PROTECTION

PROTECT your eyes and face with welding helmet properly fitted and with proper grade of filter plate (See ANSI Z49.1).

PROTECT your body from welding spatter and arc flash with protective clothing including woolen clothing, flame-proof apron and gloves, leather leggings, and high boots.

PROTECT others from splatter, flash, and glare with protective screens or barriers.

IN SOME AREAS, protection from noise may be appropriate.

BE SURE protective equipment is in good condition.

Also, wear safety glasses in work area **AT ALL TIMES.**



SPECIAL SITUATIONS

DO NOT WELD OR CUT containers or materials which previously had been in contact with hazardous substances unless they are properly cleaned. This is extremely dangerous.

DO NOT WELD OR CUT painted or plated parts unless special precautions with ventilation have been taken. They can release highly toxic fumes or gases.

Additional precautionary measures

PROTECT compressed gas cylinders from excessive heat, mechanical shocks, and arcs; fasten cylinders so they cannot fall.

BE SURE cylinders are never grounded or part of an electrical circuit.

REMOVE all potential fire hazards from welding area.

ALWAYS HAVE FIRE FIGHTING EQUIPMENT READY FOR IMMEDIATE USE AND KNOW HOW TO USE IT.



SECTION A: WARNINGS



CALIFORNIA PROPOSITION 65 WARNINGS



WARNING: Breathing diesel engine exhaust exposes you to chemicals known to the State of California to cause cancer and birth defects, or other reproductive harm.

- Always start and operate the engine in a well-ventilated area.
- If in an exposed area, vent the exhaust to the outside.
- Do not modify or tamper with the exhaust system.
- Do not idle the engine except as necessary.

For more information go to www.P65warnings.ca.gov/diesel

WARNING: This product, when used for welding or cutting, produces fumes or gases which contain chemicals known to the State of California to cause birth defects and, in some cases, cancer. (California Health & Safety Code § 25249.5 *et seq.*)



WARNING: Cancer and Reproductive Harm
www.P65warnings.ca.gov

ARC WELDING CAN BE HAZARDOUS. PROTECT YOURSELF AND OTHERS FROM POSSIBLE SERIOUS INJURY OR DEATH. KEEP CHILDREN AWAY. PACEMAKER WEARERS SHOULD CONSULT WITH THEIR DOCTOR BEFORE OPERATING.

Read and understand the following safety highlights. For additional safety information, it is strongly recommended that you purchase a copy of "Safety in Welding & Cutting - ANSI Standard Z49.1" from the American Welding Society, P.O. Box 351040, Miami, Florida 33135 or CSA Standard W117.2. A Free copy of "Arc Welding Safety" booklet E205 is available from the Lincoln Electric Company, 22801 St. Clair Avenue, Cleveland, Ohio 44117-1199.

BE SURE THAT ALL INSTALLATION, OPERATION, MAINTENANCE AND REPAIR PROCEDURES ARE PERFORMED ONLY BY QUALIFIED INDIVIDUALS.



FOR ENGINE POWERED EQUIPMENT.

- Turn the engine off before troubleshooting and maintenance work unless the maintenance work requires it to be running.
- Operate engines in open, well-ventilated areas or vent the engine exhaust fumes outdoors.
- Do not add the fuel near an open flame welding arc or when the engine is running. Stop the engine and allow it to cool before refueling to prevent spilled fuel from vaporizing on contact



with hot engine parts and igniting. Do not spill fuel when filling tank. If fuel is spilled, wipe it up and do not start engine until fumes have been eliminated.

- Keep all equipment safety guards, covers and devices in position and in good repair. Keep hands, hair, clothing and tools away from V-belts, gears, fans and all other moving parts when starting, operating or repairing equipment.
- In some cases it may be necessary to remove safety guards to perform required maintenance. Remove guards only when necessary and replace them when the maintenance requiring their removal is complete. Always use the greatest care when working near moving parts.
- Do not put your hands near the engine fan. Do not attempt to override the governor or idler by pushing on the throttle control rods while the engine is running.
- To prevent accidentally starting gasoline engines while turning the engine or welding generator during maintenance work, disconnect the spark plug wires, distributor cap or magneto wire as appropriate.
- To avoid scalding, do not remove the radiator pressure cap when the engine is hot.



ELECTRIC AND MAGNETIC FIELDS MAY BE DANGEROUS



- Electric current flowing through any conductor causes localized Electric and Magnetic Fields (EMF). Welding current creates EMF fields around welding cables and welding machines
- EMF fields may interfere with some pacemakers, and welders having a pacemaker should consult their physician before welding.
- Exposure to EMF fields in welding may have other health effects which are now not known.
- All welders should use the following procedures in order to minimize exposure to EMF fields from the welding circuit:
 - Route the electrode and work cables together - Secure them with tape when possible.
 - Never coil the electrode lead around your body.
 - Do not place your body between the electrode and work cables. If the electrode cable is on your right side, the work cable should also be on your right side.
 - Connect the work cable to the workpiece as close as possible to the area being welded.
 - Do not work next to welding power source.



ELECTRIC SHOCK CAN KILL.



- 3.a. The electrode and work (or ground) circuits are electrically “hot” when the welder is on. Do not touch these “hot” parts with your bare skin or wet clothing. Wear dry, hole-free gloves to insulate hands.
- 3.b. Insulate yourself from work and ground using dry insulation. Make certain the insulation is large enough to cover your full area of physical contact with work and ground.

In addition to the normal safety precautions, if welding must be performed under electrically hazardous conditions (in damp locations or while wearing wet clothing; on metal structures such as floors, gratings or scaffolds; when in cramped positions such as sitting, kneeling or lying, if there is a high risk of unavoidable or accidental contact with the workpiece or ground) use the following equipment:

- Semiautomatic DC Constant Voltage (Wire) Welder.
 - DC Manual (Stick) Welder.
 - AC Welder with Reduced Voltage Control.
- 3.c. In semiautomatic or automatic wire welding, the electrode, electrode reel, welding head, nozzle or semiautomatic welding gun are also electrically “hot”.
 - 3.d. Always be sure the work cable makes a good electrical connection with the metal being welded. The connection should be as close as possible to the area being welded.
 - 3.e. Ground the work or metal to be welded to a good electrical (earth) ground.
 - 3.f. Maintain the electrode holder, work clamp, welding cable and welding machine in good, safe operating condition. Replace damaged insulation.
 - 3.g. Never dip the electrode in water for cooling.
 - 3.h. Never simultaneously touch electrically “hot” parts of electrode holders connected to two welders because voltage between the two can be the total of the open circuit voltage of both welders.
 - 3.i. When working above floor level, use a safety belt to protect yourself from a fall should you get a shock.
 - 3.j. Also see Items 6.c. and 8.



ARC RAYS CAN BURN.



- 4.a. Use a shield with the proper filter and cover plates to protect your eyes from sparks and the rays of the arc when welding or observing open arc welding. Headshield and filter lens should conform to ANSI Z87.1 standards.
- 4.b. Use suitable clothing made from durable flame-resistant material to protect your skin and that of your helpers from the arc rays.
- 4.c. Protect other nearby personnel with suitable, non-flammable screening and/or warn them not to watch the arc nor expose themselves to the arc rays or to hot spatter or metal.



FUMES AND GASES CAN BE DANGEROUS.



- 5.a. Welding may produce fumes and gases hazardous to health. Avoid breathing these fumes and gases. When welding, keep your head out of the fume. Use enough ventilation and/or exhaust at the arc to keep fumes and gases away from the breathing zone. **When welding hardfacing (see instructions on container or SDS) or on lead or cadmium plated steel and other metals or coatings which produce highly toxic fumes, keep exposure as low as possible and within applicable OSHA PEL and ACGIH TLV limits using local exhaust or mechanical ventilation unless exposure assessments indicate otherwise. In confined spaces or in some circumstances, outdoors, a respirator may also be required. Additional precautions are also required when welding on galvanized steel.**
- 5.b. The operation of welding fume control equipment is affected by various factors including proper use and positioning of the equipment, maintenance of the equipment and the specific welding procedure and application involved. Worker exposure level should be checked upon installation and periodically thereafter to be certain it is within applicable OSHA PEL and ACGIH TLV limits.
- 5.c. Do not weld in locations near chlorinated hydrocarbon vapors coming from degreasing, cleaning or spraying operations. The heat and rays of the arc can react with solvent vapors to form phosgene, a highly toxic gas, and other irritating products.
- 5.d. Shielding gases used for arc welding can displace air and cause injury or death. Always use enough ventilation, especially in confined areas, to insure breathing air is safe.
- 5.e. Read and understand the manufacturer’s instructions for this equipment and the consumables to be used, including the Safety Data Sheet (SDS) and follow your employer’s safety practices. SDS forms are available from your welding distributor or from the manufacturer.
- 5.f. Also see item 1.b.



WELDING AND CUTTING SPARKS CAN CAUSE FIRE OR EXPLOSION.



- 6.a. Remove fire hazards from the welding area. If this is not possible, cover them to prevent the welding sparks from starting a fire. Remember that welding sparks and hot materials from welding can easily go through small cracks and openings to adjacent areas. Avoid welding near hydraulic lines. Have a fire extinguisher readily available.
- 6.b. Where compressed gases are to be used at the job site, special precautions should be used to prevent hazardous situations. Refer to "Safety in Welding and Cutting" (ANSI Standard Z49.1) and the operating information for the equipment being used.
- 6.c. When not welding, make certain no part of the electrode circuit is touching the work or ground. Accidental contact can cause overheating and create a fire hazard.
- 6.d. Do not heat, cut or weld tanks, drums or containers until the proper steps have been taken to insure that such procedures will not cause flammable or toxic vapors from substances inside. They can cause an explosion even though they have been "cleaned". For information, purchase "Recommended Safe Practices for the Preparation for Welding and Cutting of Containers and Piping That Have Held Hazardous Substances", AWS F4.1 from the American Welding Society (see address above).
- 6.e. Vent hollow castings or containers before heating, cutting or welding. They may explode.
- 6.f. Sparks and spatter are thrown from the welding arc. Wear oil free protective garments such as leather gloves, heavy shirt, cuffless trousers, high shoes and a cap over your hair. Wear ear plugs when welding out of position or in confined places. Always wear safety glasses with side shields when in a welding area.
- 6.g. Connect the work cable to the work as close to the welding area as practical. Work cables connected to the building framework or other locations away from the welding area increase the possibility of the welding current passing through lifting chains, crane cables or other alternate circuits. This can create fire hazards or overheat lifting chains or cables until they fail.
- 6.h. Also see item 1.c.
- 6.i. Read and follow NFPA 51B "Standard for Fire Prevention During Welding, Cutting and Other Hot Work", available from NFPA, 1 Batterymarch Park, PO box 9101, Quincy, MA 022690-9101.
- 6.j. Do not use a welding power source for pipe thawing.



CYLINDER MAY EXPLODE IF DAMAGED.



- 7.a. Use only compressed gas cylinders containing the correct shielding gas for the process used and properly operating regulators designed for the gas and pressure used. All hoses, fittings, etc. should be suitable for the application and maintained in good condition.
- 7.b. Always keep cylinders in an upright position securely chained to an undercarriage or fixed support.
- 7.c. Cylinders should be located:
 - Away from areas where they may be struck or subjected to physical damage.
 - A safe distance from arc welding or cutting operations and any other source of heat, sparks, or flame.
- 7.d. Never allow the electrode, electrode holder or any other electrically "hot" parts to touch a cylinder.
- 7.e. Keep your head and face away from the cylinder valve outlet when opening the cylinder valve.
- 7.f. Valve protection caps should always be in place and hand tight except when the cylinder is in use or connected for use.
- 7.g. Read and follow the instructions on compressed gas cylinders, associated equipment, and CGA publication P-1, "Precautions for Safe Handling of Compressed Gases in Cylinders," available from the Compressed Gas Association, 14501 George Carter Way Chantilly, VA 20151.



FOR ELECTRICALLY POWERED EQUIPMENT.



- 8.a. Turn off input power using the disconnect switch at the fuse box before working on the equipment.
- 8.b. Install equipment in accordance with the U.S. National Electrical Code, all local codes and the manufacturer's recommendations.
- 8.c. Ground the equipment in accordance with the U.S. National Electrical Code and the manufacturer's recommendations.

Refer to
<http://www.lincolnelectric.com/safety>
for additional safety information.

Electromagnetic Compatibility (EMC)

Conformance

Products displaying the CE mark are in conformity with European Community Council Directive of 15 Dec 2004 on the approximation of the laws of the Member States relating to electromagnetic compatibility, 2004/108/EC. It was manufactured in conformity with a national standard that implements a harmonized standard: EN 60974-10 Electromagnetic Compatibility (EMC) Product Standard for Arc Welding Equipment. It is for use with other Lincoln Electric equipment. It is designed for industrial and professional use.

Introduction

All electrical equipment generates small amounts of electromagnetic emission. Electrical emission may be transmitted through power lines or radiated through space, similar to a radio transmitter. When emissions are received by other equipment, electrical interference may result. Electrical emissions may affect many kinds of electrical equipment; other nearby welding equipment, radio and TV reception, numerical controlled machines, telephone systems, computers, etc. Be aware that interference may result and extra precautions may be required when a welding power source is used in a domestic establishment.

Installation and Use

The user is responsible for installing and using the welding equipment according to the manufacturer's instructions. If electromagnetic disturbances are detected then it shall be the responsibility of the user of the welding equipment to resolve the situation with the technical assistance of the manufacturer. In some cases this remedial action may be as simple as earthing (grounding) the welding circuit, see Note. In other cases it could involve construction of an electromagnetic screen enclosing the power source and the work complete with associated input filters. In all cases electromagnetic disturbances must be reduced to the point where they are no longer troublesome.

Note: The welding circuit may or may not be earthed for safety reasons according to national codes. Changing the earthing arrangements should only be authorized by a person who is competent to access whether the changes will increase the risk of injury, e.g., by allowing parallel welding current return paths which may damage the earth circuits of other equipment.

Assessment of Area

Before installing welding equipment the user shall make an assessment of potential electromagnetic problems in the surrounding area. The following shall be taken into account:

- a) other supply cables, control cables, signaling and telephone cables; above, below and adjacent to the welding equipment;
- b) radio and television transmitters and receivers;
- c) computer and other control equipment;
- d) safety critical equipment, e.g., guarding of industrial equipment;
- e) the health of the people around, e.g., the use of pacemakers and hearing aids;
- f) equipment used for calibration or measurement
- g) the immunity of other equipment in the environment. The user shall ensure that other equipment being used in the environment is compatible. This may require additional protection measures;
- h) the time of day that welding or other activities are to be carried out.

Electromagnetic Compatibility (EMC)

The size of the surrounding area to be considered will depend on the structure of the building and other activities that are taking place. The surrounding area may extend beyond the boundaries of the premises.

Methods of Reducing Emissions

Mains Supply

Welding equipment should be connected to the mains supply according to the manufacturer's recommendations. If interference occurs, it may be necessary to take additional precautions such as filtering of the mains supply. Consideration should be given to shielding the supply cable of permanently installed welding equipment, in metallic conduit or equivalent. Shielding should be electrically continuous throughout its length. The shielding should be connected to the welding power source so that good electrical contact is maintained between the conduit and the welding power source enclosure.

Maintenance of the Welding Equipment

The welding equipment should be routinely maintained according to the manufacturer's recommendations. All access and service doors and covers should be closed and properly fastened when the welding equipment is in operation. The welding equipment should not be modified in any way except for those changes and adjustments covered in the manufacturer's instructions. In particular, the spark gaps of arc striking and stabilizing devices should be adjusted and maintained according to the manufacturer's recommendations.

Welding Cables

The welding cables should be kept as short as possible and should be positioned close together, running at or close to floor level.

Equipotential Bonding

Bonding of all metallic components in the welding installation and adjacent to it should be considered. However, metallic components bonded to the work piece will increase the risk that the operator could receive a shock by touching these metallic components and the electrode at the same time. The operator should be insulated from all such bonded metallic components.

Earthing of the Workpiece

Where the workpiece is not bonded to earth for electrical safety, not connected to earth because of its size and position, e.g., ships hull or building steelwork, a connection bonding the workpiece to earth may reduce emissions in some, but not all instances. Care should be taken to prevent the earthing of the workpiece increasing the risk of injury to users, or damage to other electrical equipment. Where necessary, the connection of the workpiece to earth should be made by a direct connection to the workpiece, but in some countries where direct connection is not permitted, the bonding should be achieved by suitable capacitance, selected according to national regulations.

Screening and Shielding



















Selective screening and shielding of other cables and equipment in the surrounding area may alleviate problems of interference. Screening of the entire welding installation may be considered for special applications ¹.

¹ Portions of the preceding text are contained in EN 60974-10: "Electromagnetic Compatibility (EMC) product standard for arc welding equipment."

	Page
Installation	
Graphic Symbols That May Appear On This Machine Or In This Manual	1
Technical Specifications	2
Safety Precautions	3
Select Suitable Location	4
Environmental Area	4
Stacking	4
Tilting	4
Transport	5
High Frequency Interference Protection	5
Radio Frequency Interference	5
Product Description	6
User Interface Overview	7
Component Overview	8
Hardware Specifics	12
Hardware Uncrating	15
Setup Procedure	15
Device Labels	17
Operation	
Powering On	18
License Agreement	18
User Mode	19-26
User Mode	19
Login Screen	19
Coupon Configuration Selection Screen	20
Process Selection Screen	20
Table Setup Screens	20
Environment Screen	21
Parameter Setup Screen	22
Virtual Welding Overview	23
Visual Cues	23
GTAW Cues	24
LASER Screen	26
Technique Parameters	26
Pass Number	27
Travel Direction	27
Bead Render	28
Discontinuity Indicator	28
Score	28
Student Report	28
Instructor Mode	29-40
Instructor Mode And Admin Access	29
Weldometer	30
Tolerance Editor	31
Scoring Modules	34
Update	34
Options	35
Additional Features	36

	Page
Maintenance	
Cleaning & Maintenance.....	41
Troubleshooting	
How To Use Troubleshooting Guide	42
Troubleshooting Guide	43-44
Diagrams	
Dimensions	45
Wiring Diagrams.....	46-51
Parts	parts.lincolnelectric.com

GRAPHIC SYMBOLS THAT MAY APPEAR ON THIS MACHINE OR IN THIS MANUAL

	FUSE	U_1	INPUT VOLTAGE
	ON	I_1	INPUT CURRENT
	OFF		WARNING OR CAUTION Documentation must be consulted in all cases where this symbol is displayed.
	CIRCUIT BREAKER		POWER BUTTON
	INPUT POWER		VIRTUAL REALITY WELDING
	READ THIS MANUAL COMPLETELY		COUPON ARM CONNECTION
	USB		SHOCK HAZARD
	SMAW WELDING		ETHERNET
	GMAW WELDING		DISPLAY PORT
	GTAW WELDING		HDMI
	HEADSET		

TECHNICAL SPECIFICATIONS

INPUT			
MODEL	DESCRIPTION	INPUT VOLTAGE ± 10%	INPUT CURRENT (MAX.)
K4601-1	SINGLE USER	115/230 VAC (50/60 HZ)	2/1A SINGLE PHASE
K4602-1	DUAL USER	115/230 VAC (50/60 HZ)	4/2A SINGLE PHASE
K4603-1	TRANSPORT	115/230 VAC (50/60 HZ)	2/1A SINGLE PHASE
K4633-1	DUAL TRANSPORT	115/230 VAC (50/60 HZ)	4/2A SINGLE PHASE
 WARNING			
<p>THIS PRODUCT INCORPORATES A PROTECTIVE EARTH CIRCUIT IN THE AC POWER CORD. THE AC PLUG SHOULD ONLY BE INSERTED INTO A SOCKET OUTLET PROVIDED WITH A PROTECTIVE EARTH CONTACT. THE MAIN POWER DISCONNECT IS LOCATED IN THE REAR OF THE MACHINE. NOTE: INSTALLATION CATEGORY II EQUIPMENT.</p>			
PHYSICAL DIMENSIONS (MACHINE)			
HEIGHT	WIDTH	DEPTH	WEIGHT
28.0 in. 711 mm	20.0 in. 508 mm	34.0 in. 864 mm	150 lbs. 68 kgs.
PHYSICAL DIMENSIONS (STAND)			
HEIGHT	WIDTH	DEPTH	WEIGHT
80.0 in. 2032 mm	39.0 in. 991 mm	47.0 in. 1194 mm	105 lbs. 48 kgs.
TEMPERATURE RANGES			
OPERATING TEMPERATURE RANGE		STORAGE TEMPERATURE RANGE	
40° - 95° F (5° - 35° C)		32° - 149° F (0° - 65° C)	
RELATIVE HUMIDITY*		OPERATING ALTITUDE	
80% For Temperatures Up To 88° F / 31° C 50% @ 104° F / 40° C		6562 Feet (2000 Meters)	
ENVIRONMENT			
This product is for use in Pollution Degree 2 environment (Laboratories, Test Stations, Office Environment).			

Read entire installation section before starting installation.

Do not place objects on the VR Table, Arm or on Machine.

During lightning storms, turn off the system and unplug it from the power outlet.

Before using the headset please carefully read these safety instructions.

Read this handbook and use the headset device in strict accordance in order to prevent any damage to your eyes, other injury, loss of visual functions, property damage or death.

We strongly advise you to get familiar with the headset device and its capabilities before you use it for the first time.

SAFETY PRECAUTIONS

WARNING

ELECTRIC SHOCK can kill.

- Only qualified personnel should perform this installation.
- Turn the input power OFF and unplug the machine from the receptacle before working on this equipment.
- Always connect the VRTEX to a power supply grounded according to the National Electrical Code and local codes.
- Do not use or store the headset when wet or in wet areas.
- Do not wrap the cable around your neck, body or arms.



CAUTION

Misuse or overuse of this product may injure your eyes or affect visual function.

Overexposure to video and flashing light may cause or aggravate the following health effects to light-sensitive users:

- Eye disease and/or injury, Glaucoma.
- Epileptic (and other) Seizures.
- Heart disease or high blood pressure.

Consult your physician before using the headset if you have been diagnosed with or are susceptible to any of the above health effects.

Some users may experience a seizure when exposed to certain visual images, including flashing lights or patterns. Even people who have no history of seizures or epilepsy may have an undiagnosed condition that can cause “photosensitive epileptic seizures.”

Seizures may cause loss of consciousness or convulsions that can lead to injury from falling down or striking nearby objects.

Do not use the headset when you are drowsy or fatigued.

Immediately, stop using the Headset and consult your physician if you experience any of the following symptoms:

- Double vision or inability to focus on the display.
- Nausea or motion sickness.
- Eye fatigue or irritation.
- Headaches or dizziness.
- Aches and pain in the neck or shoulders.

HEADSET SAFETY PRECAUTIONS

Adjust the headband so the headset is secure and will not fall off in use. Do not use the headset if temperature is below 32°F/0°C or above 104°F/40°C or in wet, humid, dusty or smoky areas.

Avoid dropping or impact of the headset frame and displays. If the headset is damaged contact your retailer. There are no user serviceable parts. Only qualified service personnel should perform any repair on this product.

Avoid exposing the headset to direct sunlight or intense / high-powered lighting.

ESD SENSITIVITY

This headset eyepiece device may be sensitive to electrostatic discharge of 8 kV or higher. Observe static precautions such as discharging the body by touching the metal chassis of the grounded equipment prior to touching the eyepiece.



SELECT SUITABLE LOCATION

The machine will not operate in harsh environments. It is important that simple preventative measures are followed in order to assure long life and reliable operation. This product is for INDOOR USE ONLY.

- Dirt and dust that can be drawn into the machine should be kept to a minimum. Failure to observe these precautions can result in excessive operating temperatures and nuisance shutdown.
- See **Technical Specifications** for operating environment conditions.
- Do not place machine where monitor and/or headset is exposed to direct sunlight or high powered lighting.
- Do not place equipment near radiant heat sources.
- Do not place in a confined space. Allow a minimum of three feet of clearance around machine and stand at all times. Adequate ventilation is necessary.
- The fused power switch on the rear panel is the input power disconnect device. Do not position the equipment so that it is difficult to operate the fused power switch.
- Route and protect all cables to minimize exposure to damage.
- Single or Multi-Outlet surge protector (or Surge Suppressor) is highly recommended to protect the machine from voltage spikes going through the input line.
- An uninterruptible power supply (UPS) may be required for the protection of the system from power irregularities and disruption.

NOTE: The system requires approximately 8' L x 8' D x 8' H (2.4 m L x 2.4 m D x 2.4 m H) of space.

Keep the area free of obstruction for at least 3 feet in all directions of both the stand and VR weld machine. In addition, be conscious of where you are placing the unit to avoid magnetic fields, conductive and high frequency objects and processes.

NOTE: Avoid setting up the VRTEX near high frequency TIG machines and power sources.

Having these types of objects in the area can cause interference and result in increased jitter and/or distortion in the motion tracking.

For best results, do not install VRTEX machine in the welding lab. Electrical interference from power lines, though generally small, can be present. Therefore all electrical power or lighting wiring within 50 feet of the welding area shall be enclosed in grounded rigid metallic conduit. In the event the VRTEX is affected by interference, it is the user's responsibility to take steps to isolate and/or eliminate the interference.

When exposed to transient electrical disturbances with a magnitude of 1kV or higher, the video monitor may fail to respond to signal changes and require the main system to be reset by the user to resume normal intended operation. If this occurs, prevention of future occurrences may be achieved by moving the system away from large electrical machinery and/or devices that switch large electrical loads.

When exposed to radio frequency noise of 3Vrms in the frequency range of 50-80 Mhz, the system may experience a "rest" and/or other unintended operation. If this occurs, prevention of future occurrences may be achieved by moving the system away from any potential sources of radio frequency noise such as radio communication towers or the like.

MULTIPLE SYSTEM INSTALLATIONS

If multiple systems are required to operate together in one location, a unique frequency can be selected to reduce potential interference between systems. In general, a setup (pole and table assembly) must be kept at least 10 feet away from another setup using the same frequency. By default the machines are programmed as followed:

	SIDE B	SIDE A
VRTEX 360+	SENSOR SETTING 2	SENSOR SETTING 3
VRTEX 360	N/A	SENSOR SETTING 3
VRTEX TRANSPORT	N/A	SENSOR SETTING 3
VRTEX TRANSPORT+	SENSOR SETTING 2	SENSOR SETTING 3

If interference is noticed, the frequency can be adjusted by entering Administrator Access, Options and choosing a different "Magnetic Frequency ID" number.

ENVIRONMENTAL AREA

Keep the machine inside and dry at all times. Do not place it on wet ground or in puddles. Never place liquids on top of the machine.

STACKING

The VRTEX cannot be stacked.

TILTING

Place the VRTEX directly on a secure, level surface.

TRANSPORT

The VRTEX has two swivel, locking casters for easy transport. When the VRTEX is not being transported be sure the machine is on level ground and lock the casters to prevent unwanted movement.

- Only transport the machine on level ground.
- Move the machine slowly and only when all four wheels are in contact with the ground.
- Do not move over uneven ground or curbs.
- The VRTEX should never be lifted with an overhead crane.

HIGH FREQUENCY INTERFERENCE PROTECTION

CAUTION

USE CAUTION WHEN OPERATING THIS MACHINE AROUND OTHER EQUIPMENT.

- Large equipment, such as cranes, may interfere with the operation of this machine.
- This machine may interfere with the operation of other equipment in work / training area.
- High frequency process, such as TIG machines, may interfere with the operation of this machine.
- Welding / cutting machine with improper grounding may interfere with the operation of this machine.

RADIO FREQUENCY INTERFERENCE

This system contains a sensitive magnetic positioning sensor that can become disturbed in the presence of conducted RF noise. Disturbances can manifest themselves in slight jarring of the virtual environment.

If interference on the sensor cable is an issue, it should be repositioned until the jarring stops. In the case of noise on the AC port being an issue, a noise suppressing ferrite bead can be added to the AC power cord which will eliminate the interference. Please contact your Lincoln Electric Support Center for details.

PRODUCT DESCRIPTION

The VRTEX is a virtual reality arc welding trainer. This computer based training system is an educational tool designed to allow students to practice their welding technique in a simulated environment. It promotes the efficient transfer of welding skills from the classroom to the welding booth, while reducing material waste and energy consumption associated with traditional welding training.

The VRTEX is a virtual reality arc welding training machine only and NOT a real arc welding machine. Please be aware of all standard safety practices associated with welding. Some standard warnings are included in this manual.

If the equipment is used in a manner not specified by the manufacturer, the protection provided to the equipment and user may be impaired.

Access panels are not to be removed except by qualified service personnel due to risk of electric shock from accessible live parts.

The VRTEX machine is available in four different configurations. This manual can be used for all four.





VRTEX 360+

DUAL USER MACHINE: ALLOWS TRAINING OF TWO PEOPLE AT THE SAME TIME.
QTY: 2, ACTIVE SMAW DEVICE, GMAW GUN, GTAW GUN AND FILLER
QTY: 2, FULL SIZE STAND AND TABLE ASSEMBLY
QTY: 2, FLAT PLATE, GROOVE, T, LAP JOINT, 2" PIPE, 6" PIPE, PIPE ON PLATE
6 DIFFERENT WELDING ENVIRONMENTS
THEORY, DEMO MODE, STUDENT REPLAY, GRAPHIC CUES, BEND TEST, SCORING MODULES, LESSON MODE
HORIZONTAL, VERTICAL, OVERHEAD WELDING

Figure 1 – VRTEX configurations

VRTEX 360	VRTEX TRANSPORT	VRTEX TRANSPORT+
		
SINGLE USER MACHINE	SINGLE USER MACHINE	DUAL USER MACHINE: ALLOWS TRAINING OF TWO PEOPLE AT THE SAME TIME.
ACTIVE SMAW DEVICE, GMAW GUN, GTAW GUN AND FILLER	GTAW/SMAW/GMAW COMBO DEVICE AND FILLER	QTY:2, GTAW/SMAW/GMAW COMBO DEVICE AND FILLER
FULL SIZE STAND AND TABLE ASSEMBLY	TABLE TOP ASSEMBLY	QTY: 2, TABLE TOP ASSEMBLY
FLAT PLATE, GROOVE, T, LAP JOINT, 2" PIPE, 6" PIPE, PIPE ON PLATE	FLAT PLATE, GROOVE, T, LAP JOINT	QTY: 2 FLAT PLATE, GROOVE, T, LAP JOINT
6 DIFFERENT WELDING ENVIRONMENTS	4 DIFFERENT WELDING ENVIRONMENTS	4 DIFFERENT WELDING ENVIRONMENTS
THEORY, DEMO MODE, STUDENT REPLAY, GRAPHIC CUES, BEND TEST, SCORING MODULES, LESSON MODE	THEORY, DEMO MODE, STUDENT REPLAY, GRAPHIC CUES, LESSON MODE	THEORY, DEMO MODE, STUDENT REPLAY, GRAPHIC CUES, LESSON MODE
HORIZONTAL, VERTICAL, OVERHEAD WELDING	HORIZONTAL, VERTICAL WELDING	HORIZONTAL, VERTICAL WELDING

USER INTERFACE OVERVIEW

See **Figure 2** for locations of main unit control and connection points. Dual user unit shown.

1. The **Power Button** powers on/off the VRTEX system.
2. The **Cable Support Box Mount** allows the cable support box to attach the main unit to prevent unnecessary strain on gun device cables.
3. The **USB Ports** are used to upload software and download user data from the system.
4. The **Gun Connections** are used to attach the control cable for the various VR welding devices.
5. The **Headset Connections** are used to attach the control cables for headset.

Figure 2 – Front of machine

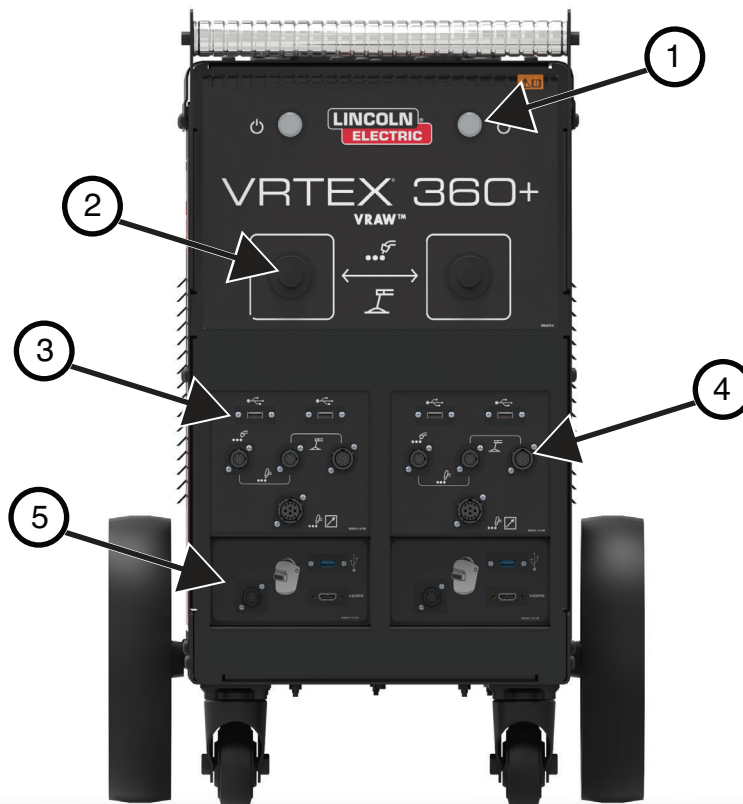

COMPONENT OVERVIEW

See **Figure 3** for locations of VRTEX 360+ system components.

1. Post
2. Touchscreen Monitor
3. VRTEX Machine
4. Swingarm
5. Table
6. Stand Assembly
7. Foot Amptrol
8. Headset
9. Coupons

Figure 3 – VRTEX 360+ system components



See **Figure 4** for locations of VRTEX 360 system components.

1. Post
2. Touchscreen Monitor
3. Coupons
4. Swingarm
5. Table
6. Headset
7. Stand Assembly
8. VRTEX Machine
9. Foot Amptrol

Figure 4 – VRTEX 360 system components



See **Figure 5** for locations of VRTEX Transport system components.

1. Coupon Stand
2. Touchscreen Monitor
3. Headset
4. Coupons
5. GTAW Filler
VR GTAW/SMAW/GMAW Combo Device
6. Foot Amptrol
7. VRTEX Machine

Figure 5 – VRTEX transport system components



See **Figure 6** for locations of VRTEX Transport+ system components.

1. Coupon Stand
2. Touchscreen Monitor
3. Headset
4. Coupons
5. GTAW Filler
VR GTAW/SMAW/GMAW Combo Device
6. Foot Amptrol
7. VRTEX Machine

Figure 6 – VRTEX Transport+ system components



HARDWARE SPECIFICS

VR GMAW/FCAW GUN

The VR gun has a trigger that is used during the simulation of GMAW and FCAW processes to initiate and maintain the simulated welding arc.

Figure 7 – VR GMAW/FCAW gun



VR SMAW DEVICE

The VR SMAW device has a rod that represents a stick electrode. This rod retracts when a virtual arc is struck to simulate the electrode burning off during the virtual welding process. When the virtual electrode burns down to a stub, the rod will stop retracting and the user will no longer be able to weld. When the user presses “new stick” in the orange actions and cues menu icon, the rod extends out, simulating that a new electrode was put into the VR SMAW device.

In order to strike an arc with the VR SMAW device, gently strike or tap the tip of the rod (of the VR SMAW device) on the coupon being welded. To break the arc, move the VR SMAW device rod away from the work piece.

CAUTION

Do not try to strike the arc with excessive force, as the arc start is distance based. Excessive force may result in damage to the VR SMAW device.

The angle of the rod can be changed by squeezing the handle of the VR SMAW device. This allows the rod to be moved into the 45 or 90 degree position. Once the rod is at one of these angles, release the handle. The rod should now be fixed in that position. **Do not change the rod angle while the rod is extending or retracting.**

Figure 8 – VR SMAW device



VR GTAW TORCH AND FILLER

The VR GTAW torch also includes a footpedal that is used during the simulation of GTAW processes to initiate and maintain the simulated welding arc. The VR GTAW torch and filler should be placed in the front storage drawer when not in use. Also note the LASER screen will evaluate both the GTAW torch and filler. The welding arc can be initiated by the footpedal, hand amptrol or lift start.

Figure 9 – VR GTAW torch and filler



UNIGUN DEVICE - VRTEX TRANSPORT ONLY

The Unigun device contains a swappable head to allow switching between GMAW, GTAW and SMAW. The GMAW configuration has a trigger that is used during the simulation to initiate and maintain the simulated welding arc. The SMAW configuration has a stationary rod that represents a stick electrode. This rod will appear and decrease in length when welding in the virtual environment.

Figure 10 – Unigun device



HEADSET

HEAD SIZE ADJUSTMENT: To adjust the headset size, loosen the straps on the sides and top. Put on the headset starting with the back strap then move the front display down over the eyes. Hold the display and adjust the straps until snug.

IMAGE ADJUSTMENT: If the image appears blurry, a small slider on the bottom of the headset can be moved to adjust the display.

EARPHONES: Adjust the earphones to fit over the ears. Volume can be changed in the software.

Figure 11 – Headset components

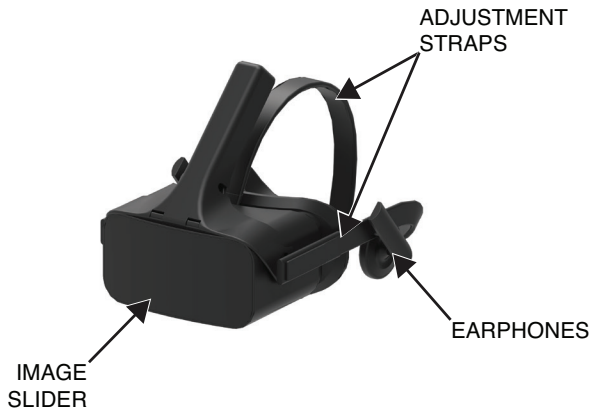

COUPON COMPARTMENT

The coupon compartment, in the stand, houses the physical coupons. When not in use, the coupons should be stored in the compartment and/or in the front storage drawer. Each coupon fits in its own area defined by the foam located in the compartment.

Figure 12 – Coupon compartment



COUPONS

The coupons represent the various workpieces on which the user can virtually weld. During the virtual welding process, they provide physical feedback to the student.

There are seven VR Coupons:

1. Flat Plate
2. T-Joint
3. V Groove
4. 2" Pipe XXS
5. 6" Pipe Schedule 40
6. Lap Joint
7. Pipe On Plate

Figure 13 – VR Coupons

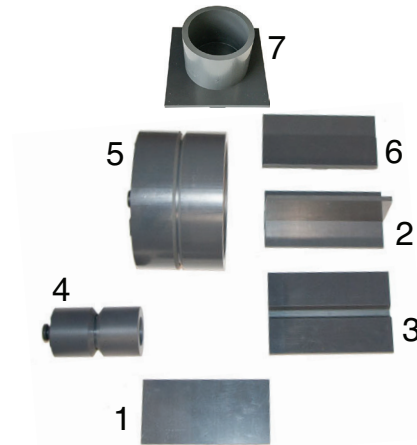

The coupons along with all VR devices have been factory calibrated by The Lincoln Electric Company.

STAND ASSEMBLY

The stand is comprised of the post, arm (connected to the machine), table, three pins, base and two weights. Users should position themselves at the stand during virtual welding. **The weights must be attached to the stand with included hardware.**

POST

The arm and table slide up and down and rest on the collar pins that are inserted into the post. Hole numbers 1 through 28 indicate position of welding for program accuracy. The position that the table or arm is located is read by identifying the numbered hole that the pin has been inserted into.

Figure 14 – Post w/pin inserted in #13

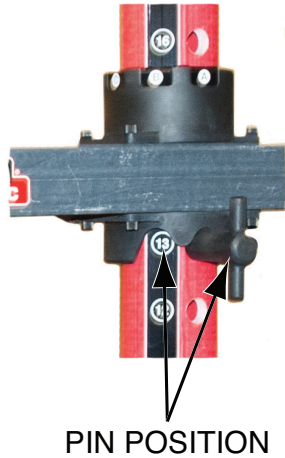

COUPON POSITIONING IN SWING ARM

The coupons can be inserted into the arm to accommodate flat, horizontal, vertical or overhead welding positions. The knob on the front of the swing arm can be pulled out for coupons to be inserted or removed and pushed in for coupons to be secured. The front of the swing arm can be rotated down at a 45 or 90-degree angle to allow 2G, 5G and 6G pipe welding positions. The arm can also be rotated around the post to comfortably accommodate left and right handed welders or simulate specific welding applications.

Figure 15 – Coupon insertion / removal



CAUTION

Do not use excessive force when inserting and removing coupons into the arm.

Figure 16 – Swing arm rotation

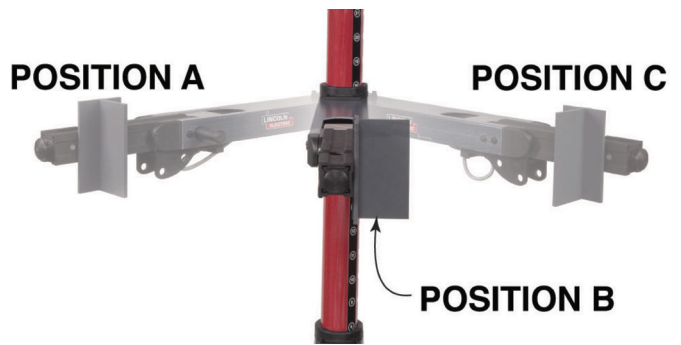

TABLE

The table can be used to gain stability and learn proper body positioning. The base supports the stand and has weights on the back to maintain stability. The table can be swung out of the way when not in use. The table also has storage compartment for the coupons.

CAUTION

Do not use the Stand/Table without the base counter weights properly positioned.

HARDWARE UNCRATING

1. Using a utility knife, carefully remove the two plastic bands securing the carton to the skid. See **Figure 17**.
2. Carefully lift the carton off of the machine.

Figure 17 – Plastic band and carton



3. Using a utility knife, carefully remove the plastic bands securing the machine to the skid.
4. Unlock the front caster brakes.
5. Using two people, carefully lift and roll the machine off of the skid and place in the desired work space.
6. Using a utility knife, carefully remove the two plastic bands securing the shipping crate to the skid. See **Figure 18**.
7. Carefully lift the lid off of the shipping crate.

Figure 18 – Plastic band and lid removal

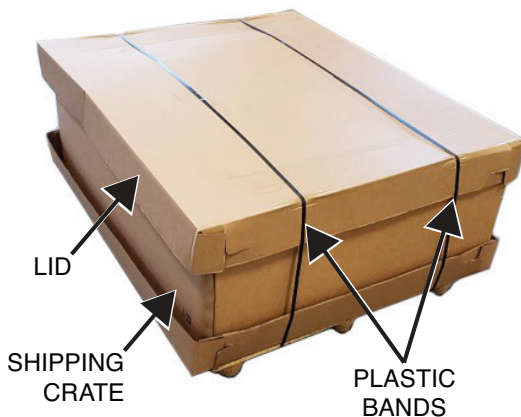

8. Remove all components from the shipping crate.
9. Place all items into desired work space to begin setup procedure.

SETUP PROCEDURE

1. Carefully position the stand base assembly in the desired work space. See **Figure 19**.

Figure 19 – Stand base

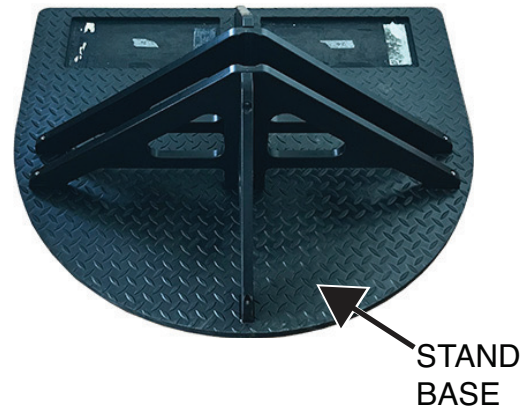

2. Position the two weight assemblies into the stand base. See **Figure 20**.
3. Attach the center screw to secure each weight assembly to the stand base. See **Figure 20**.

NOTE: The two weight assemblies must be installed before continuing with the setup procedure.

Figure 20 – Weight assemblies

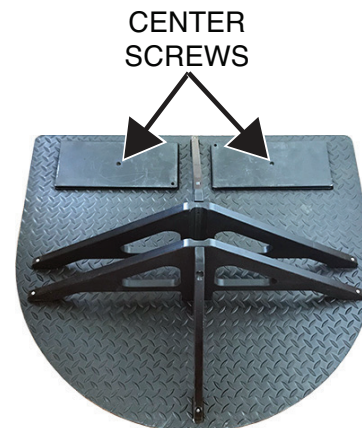

4. Using a 3/16" allen key, remove the two long screws from the stand base. Retain screws, nut and washer. See **Figure 21**. Note nut and washer placement for reassembly.
5. Carefully insert the lower pole section into the stand base. The lower pole section is keyed and will only fit properly when installed accordingly. See **Figure 21**.
6. Using a 3/16" allen key, attach the two previously removed screws securing the lower pole section to the stand base. See **Figure 21**.

Figure 21 – Lower pole section installation

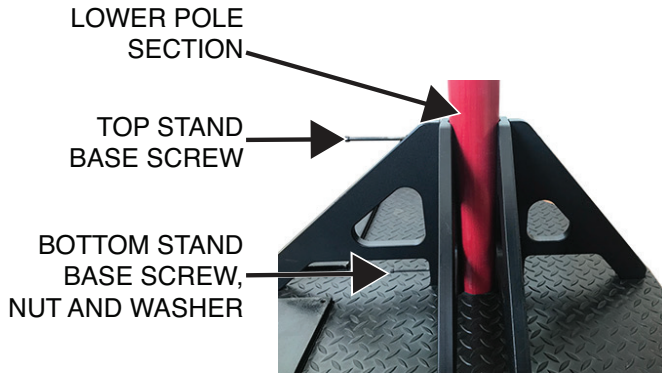

- Using a slotted screwdriver, remove the two screws from the top of the lower pole. Retain the two screws. See **Figure 22**.

Figure 22 – Pole screws

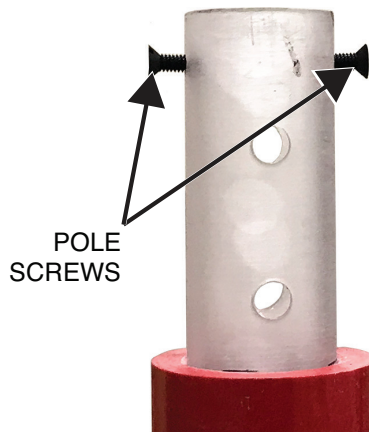

- Carefully position the table assembly onto the lower pole. See **Figure 23**.
- Carefully position the coupon arm onto the lower pole. See **Figure 23**.
- Carefully position the monitor arm onto the lower pole. See **Figure 23**.

CAUTION

Use caution when unpackaging the monitor arm assembly. The monitor arm is under tension and can spring open, handle with care.

Figure 23 – Stand component installation



- Carefully position the top pole onto the lower pole and align the position numbers. See **Figure 24**.

Figure 24 – Top pole section installation



- Using a slotted screwdriver, attach the two previously removed screws (in step 7) securing the top and lower poles together.

NOTE: Do not over-tighten the screws, this can damage the lower pole.

- Using the four thumb screws (found in device box), secure the monitor to the monitor arm.
- Carefully raise the monitor arm to position 16 and secure in place with a pin. See **Figure 25**.
- Carefully raise the coupon arm to position 10 and secure in place with a pin. See **Figure 25**.
- Carefully raise the table assembly to position 3 and secure in place with a pin. See **Figure 25**.
- Place a pin in the center of the coupon arm to hold the coupon parallel to the table. See **Figure 25**.

Figure 25 – Stand component positions



- Connect the coupon arm amphenol to the rear of the machine.
- Connect the USB, DisplayPort and power cables to the appropriate ports on the bottom of the monitor.
- Route cables thru the cable holder on the bottom of the monitor arm.
- Connect the USB, DisplayPort and power cables to the appropriate ports on the rear of the machine.

22. Connect the power cable. Leave the fused power switch/rocker in the 'Off' position.

NOTE: Surge protector (or surge suppressor) may be used to protect the electronic components of the machine from input power surges.

23. Connect the headset USB, HDMI and amphenol to the front of the machine.

24. Connect the desired welding device to the appropriate terminals on the front of the machine.

25. Route all cables in a safe manner to avoid any tripping hazards.

26. Carefully secure the desired coupon onto the coupon arm. See **Figure 26**.

Figure 26 – Coupon placement



27. The weld simulation can be broadcast on an external display by using the HDMI connection.

NOTE: The ethernet port on the rear of the machine is for future development, do not connect anything to the ethernet port.

NOTE: If disassembly is necessary, be sure to lower all stand components to the lowest positions and remove the top pole section before removing any stand components.

28. Place the fused power switch/rocker into the 'On' position.

DEVICE LABELS

The devices for each VRTEX machine are calibrated for optimal performance. It is not recommended to swap a device between machines because the device may not appear properly in the virtual environment.

Each device is labeled with a "Tool Ref No". This number appears on the front (or each side) of the VRTEX machine. The user should ensure the number on the device matches the number on the machine.

POWERING ON

* Ensure coupon arm cable is connected before turning on the machine.

1. Pressing the **power button** on the front of the machine powers up the VRTEX system. See **Figure 27**.

NOTE: Select Log Out and Shutdown from the red menu icon to turn off the system. Pressing the power button will also shutdown the system.

Figure 27 – Power button



NOTE: Main power disconnect located in the rear of the machine.

LICENSE AGREEMENT

The License Agreement is an agreement to the terms and conditions on which Lincoln Electric grants to the business entity registered with Lincoln on the purchase of the Software (“Software Licensee”), a non-exclusive license to use the Software and Documentation accompanying this license on the VRTEX Virtual Reality Welding Trainer. The license granted herein is strictly limited to the installation of said Software on the VRTEX Virtual Reality Welding Trainer that the Licensee has properly registered with Lincoln.

This is the first screen that will appear once the Software upgrade has been accomplished. In past upgrades the system would move directly into the License page of the Instructors mode. This upgrade the user must agree to the terms and conditions before moving forward.

SELECTING AGREE OR DO NOT AGREE

Once the user has completely read the EULA select the “I have read the EULA and agreed to its terms” and move forward or select “I do not agree” which will turn off the machine. Selecting the “I have read the EULA and agreed to its terms” will take the user to the “License” screen.

NOTE: The user cannot continue on the VRTEX until they AGREE to the License Agreement.

Figure 28 – End user license agreement (EULA)

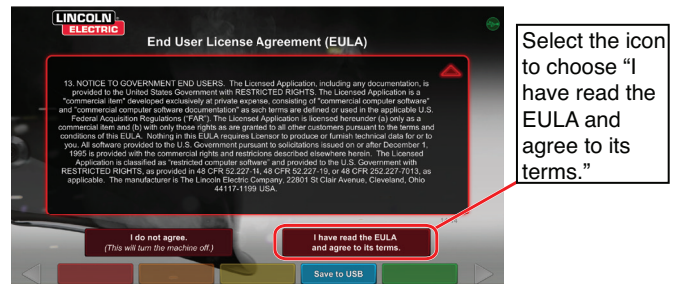

USER MODE

LOGIN SCREEN

SYSTEM SETUP INFORMATION

When setting up the virtual equipment, the user must set the welding parameters (e.g. wire feed speed for VR GMAW) within the ranges set in the tolerance editor. The system ships with Lincoln default tolerances. Lincoln default tolerances can be reviewed in the tolerance editor or in the WPS manual.

However, users can set and use their own tolerances for teaching beginner welders. The tolerances also determine how the user is scored on such parameters as work angle, travel angle, travel speed, position and contact tip to work distance or arc length. See the **Tolerance Editor** section for more details.

OVERVIEW

This page allows the user to: (See **Figure 29**)

- Enter Username
- Select Language Preference (Orange Icon)
- Select Imperial or Metric Units (Blue Icon) - See **Table 1** for details
- Shutdown System (Red Icon)
- Continue to the next Setup Screen (Green Icon)
- Select Theory (Yellow Icon)

Figure 29 – Login screen

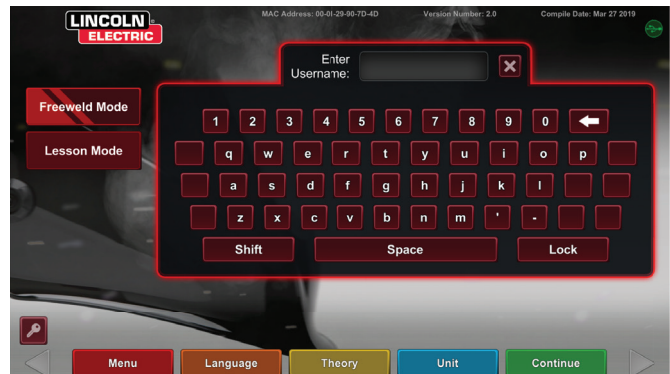

Table 1 – Measurement units

MEASUREMENT UNITS	Imperial		Metric	
	Abbrev.	Details	Abbrev.	Details
Coupon Thickness	in.	inches	mm	millimeters
Gas Flow Rate	CFM	cubic feet per minute	LPM	liters per minute
Wire Feed Speed	IPM	inches per minute	MPM	meters per minute
Weldometer - Base Metal	lbs	pounds	kg	kilograms
Weldometer - Gas	CF	cubic feet	L	liters
Weldometer - Consumables	lbs	pounds	kg	kilograms

1. USB Indicator

The circular USB icon in the upper right corner of the screen indicates the presence of a USB memory stick in the front of the machine. Translucent: no USB stick connected, Green: USB connected and ready, RED: writing data (do not remove).

2. Theory Screen

The theory icon has been implemented to assist users with additional content, images and information related to the area of the application where you are working. See **Figure 30**. This information can be accessed by selecting the yellow theory icon. When selected, the icon allows the student to access visual and definitional information about the different welding terms being used on each screen. Welding terms that correspond with each page are listed in the boxes on the left-hand side of the screen. When finished reviewing the theory data, the student can select the theory icon again to exit the screen.

Figure 30 – Theory screen

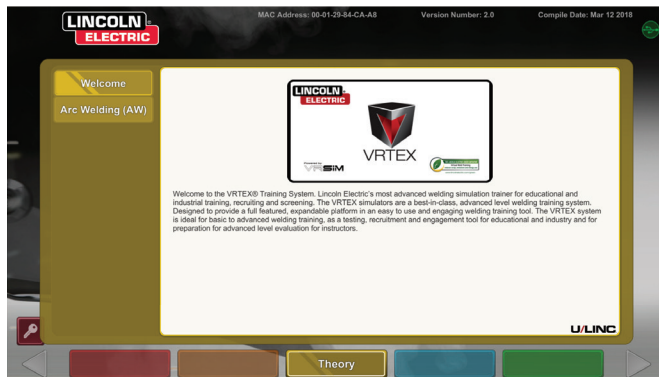

PROCESS SELECTION SCREEN

OVERVIEW

This screen allows the user to select the welding processes. See **Figure 32**. To change among VR GMAW, VR FCAW and VR SMAW, the user touches the desired processes. If a process is not supported for the selected material/thickness, it will not appear on this screen and cannot be selected. To choose among different sub-processes, touch the appropriate icon.

At the top of the screen, the user can see the coupon position and thickness selected. As the user continues to set up the simulation, additional information will be added to the right of this readout so that the user can reference what has previously been selected.

Figure 32 – Process selection screen

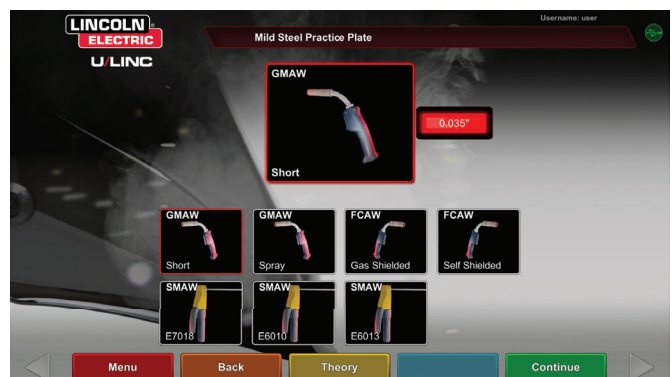

COUPON CONFIGURATION SELECTION SCREEN

OVERVIEW

The user selects which coupon configuration they want to virtually weld. (Red arrows change material type). See **Figure 31**.

Figure 31 – Joint configuration screen

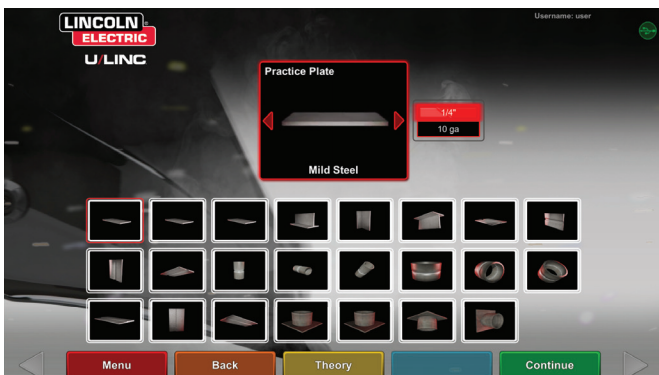
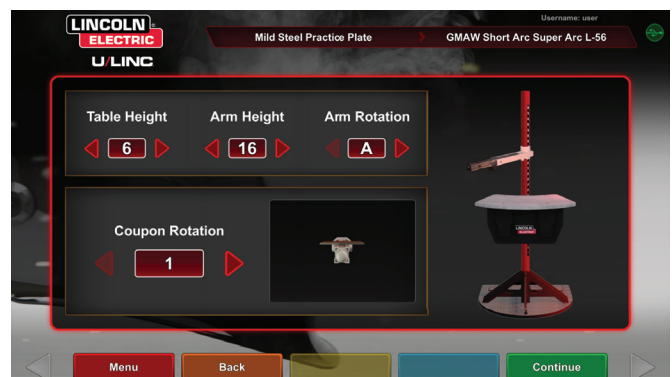

TABLE SETUP SCREENS

OVERVIEW

Figure 33 – Table setup screen



The correct VR table information must be selected for the VRTEX to operate properly in all virtual welding applications. See **Figure 33**. After entering the table setup information and selecting the green continue icon, the screen will display a representation of the table setup and the status of the necessary connected devices. A green checkmark will indicate a properly connected device and a red X will indicate a disconnected device. See **Figures 34 and 35**.

Figure 34 – Table setup & device status screen (showing SMAW device needed but not connected)

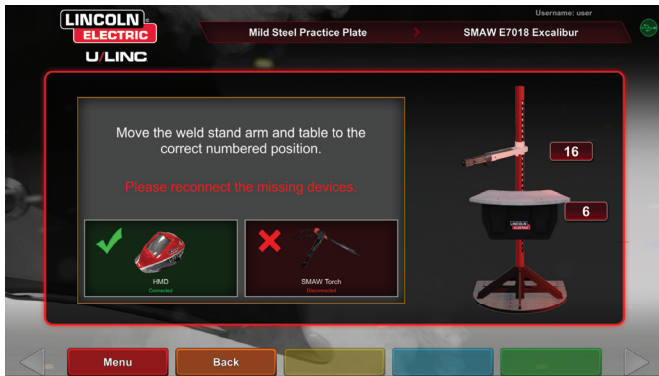
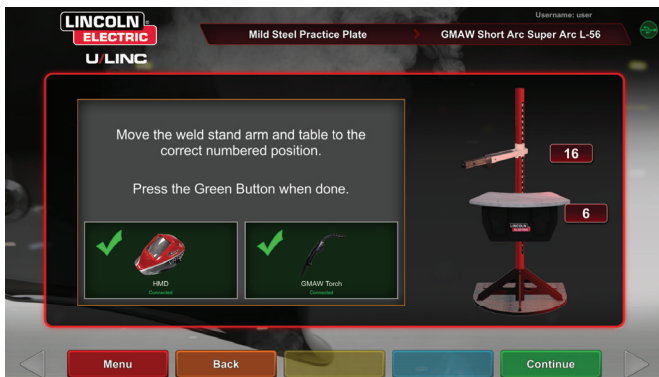

Figure 35 – Table setup & device status screen (showing all needed devices are connected)



COUPON INSERTION

Insert the VR coupon into the desired position in the VR table. See **Figure 36**. Make sure the coupon is fully seated into the track and then lock the coupon in place by pushing in the knob at the end of the arm. To release, pull the knob into the unlocked position and remove the coupon. When the system is in use, the coupon should always be locked in place to assure system accuracy.

CAUTION

Position coupon stand at least eighteen inches from monitor and any potential source of electrical and magnetic interference.

Figure 36 – VR coupon (unlocked position)



ENVIRONMENT SCREEN

OVERVIEW

The VRTEX comes pre-configured with a number of different virtual welding environments. To select an environment, touch the desired icon. See **Figure 37**.

CAUTION

When welding in virtual reality be mindful of your real world surroundings and hazards at all times to avoid injury.

Figure 37 – Environment screen

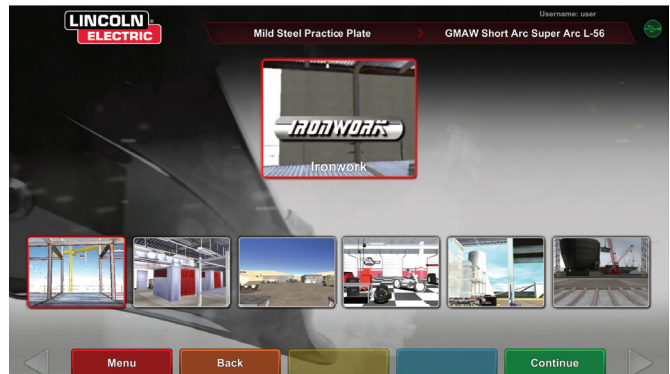

PARAMETER SETUP SCREEN

OVERVIEW

On this screen, the user selects the welding parameters. See **Figure 38**. The welding parameters must be entered according to the tolerance editor.

Figure 38 – Polarity selector screen

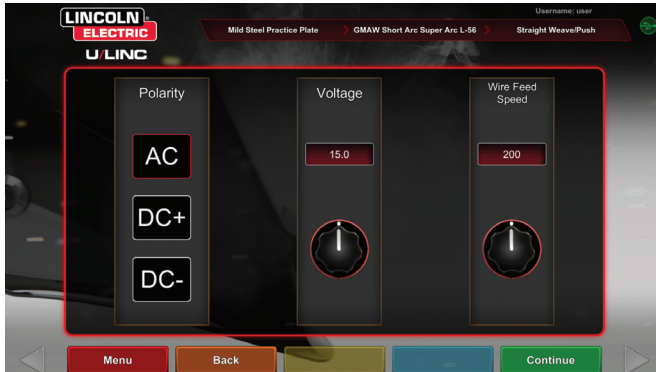

If default tolerances are being used, refer to the WPS manual.

Once the user has set the welding parameters, select the green check settings icon. If the user has entered any settings outside the acceptable range, the incorrect weld setting screen will appear and will not allow the user to proceed. Once the settings are correct, the program will enter the virtual environment.

VIRTUAL WELDING OVERVIEW

While a user is welding, observers can see the welder's view, Live Action Student Evaluation Report (LASER) screen or instructor's view displayed on the monitor. See **Figure 39**. The welder's view shows what the user with the headset on is seeing through the headset. The Live Action Student Evaluation Report (LASER) screen displays a real time graph of the weld being made and gives a score when the user selects "end pass". The instructor's view allows another user to zoom in/out, pan and rotate the coupon to view the weldment from different angles in real time. Use the white "Next" or "Prev" arrows to select different views.

Figure 39 – User screen view

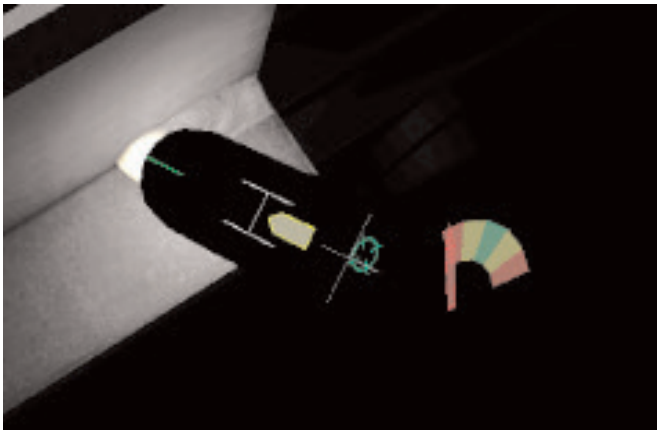

UPPER OVERLAYS

The welding technique set in the tolerance editor and other process details are displayed on the upper right portion of the screen.

ORANGE VISUAL CUES ICON

The orange action menu icon has the following options:

- Travel Speed
- AIM
- Travel/Work Angles
- CTWD (Contact To Work Distance)
- Arc Length
- Postflow
- Filler Movement
- Filler Dip Frequency
- Weave
- Whip

Only available cues will appear (based on welding process).

VISUAL CUES

Visual cues are aids to help users learn faster. The travel speed, CTWD, arc length and travel/work angle cues indicate whether the user is within the tolerances set in the tolerances editor. Generally, these cues are color coded as well as symbolic. When cues are red, they indicate being out of tolerance. Yellow cues indicate close to tolerance, but not optimal. Green cues indicate being within tolerance and close to optimal.

The **"Cheater" Lens** magnifies the image as seen by the user in the headset and in the welder's view. The user can toggle between Off, 1.25X, 1.5X, 1.75X, 2X select their option with the red select icon.

Travel Speed turns on the travel speed visual cue. See **Figure 40**. This cue uses the color coding position to indicate travel speed.

NOTE: The goal is to keep the arrow in the center of the graph which will also keep it green.

Figure 40 – Travel speed

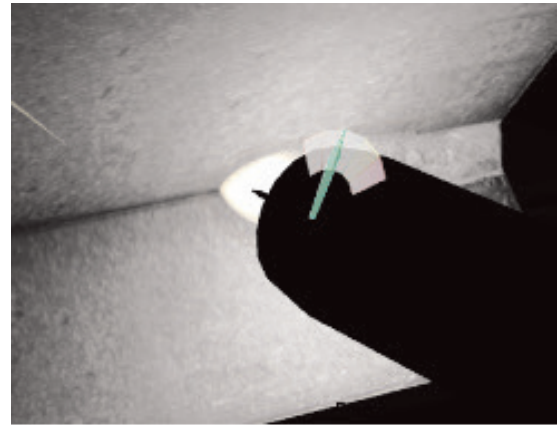

The **CTWD** (Contact Tip To Work Distance) cue uses color and position to indicate proper CTWD. See **Figure 41**. The goal is to get the tip of the green arrow on the line of the "H" bar and keep the arrow color green (also known as Arc Length).

Figure 41 – CTWD (contact tip to work distance)

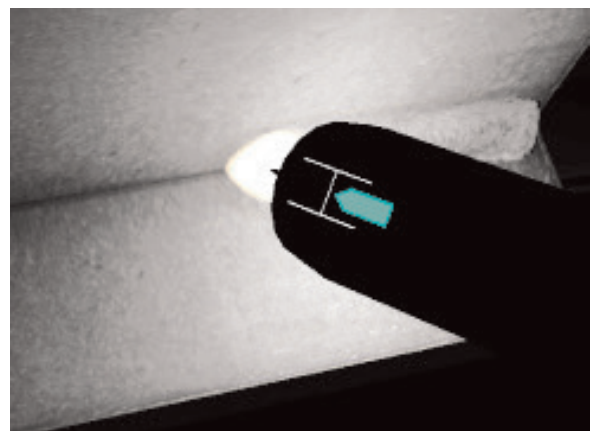

The **Travel/Work Angle** cue can be used with the SMAW, GMAW or FCAW processes. See **Figure 42**. The goal of this cue is to center the circle in the cross hair and keep the color green.

Figure 42 – Travel/work angle

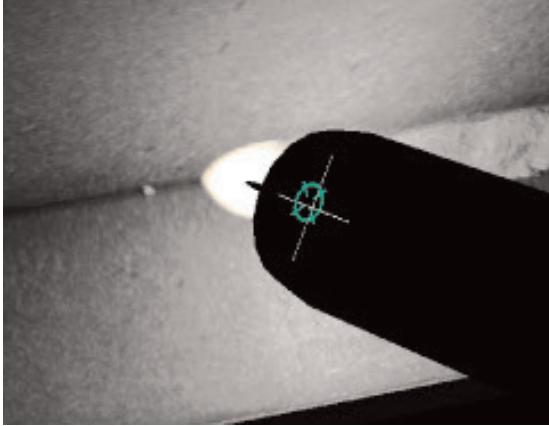

The **Aim** cue can be used with the VR SMAW, VR GMAW or VR FCAW processes. See **Figure 43**. The goal of this cue is to position the VR GMAW/FCAW Gun or VR SMAW device so the aim cue is a thin green line. This indicates that the weld is being made in the correct location or position.

Figure 43 – Aim

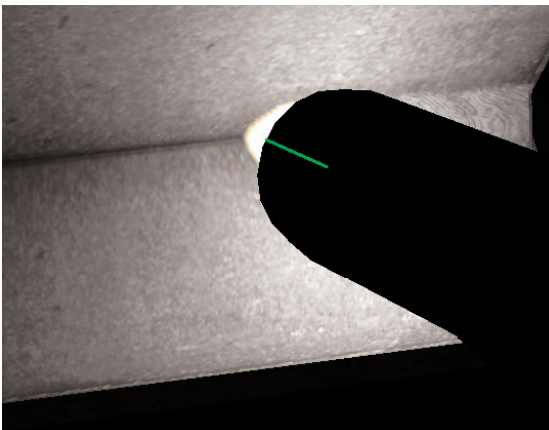

The **Whip** cue helps the student use correct spacing between whipping motions, puddle time and whip time. Correct whipping technique is indicated by a green outer ring (spacing) with a green center (puddle and whip timing).

Figure 44 – Whip

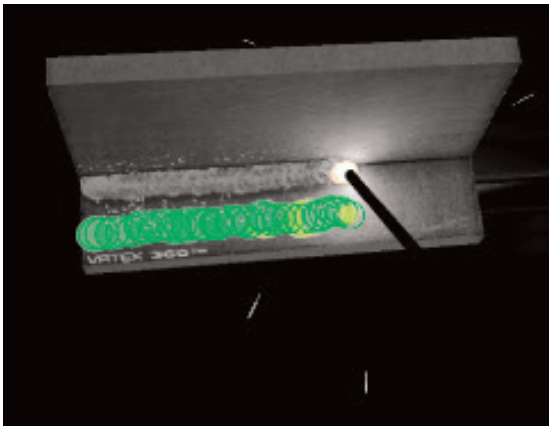

The **Weave** cue can be used to space the weave so the outer ring is green (good weave spacing), set the width of the weave so line is green (good weave width) and a green filled ring (good dwell time on the toes of the previous weld).

Figure 45 – Weave

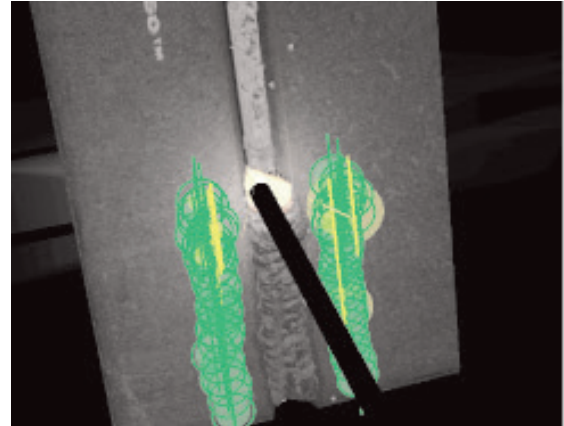

GTAW CUES

GTAW can either be done with or without filler metal. Several customized cues have been created for the GTAW process.

FILLER DIP FREQUENCY

1. When the Rhythm Guide is at its smallest, put filler into puddle. See **Figure 46**.
2. When the Rhythm Guide is at its largest, remove filler from puddle. See **Figure 46**.

Figure 46 – Filler Dip Frequency

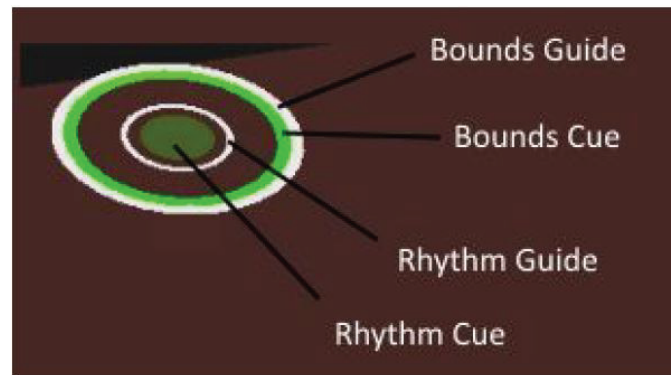

FILLER MOVEMENT

1. Position the Filler so the Position Cue matches to contours of the Aim Guide. See **Figure 47**.
2. The Aim Tether shows the distance disparity between the Aim Cue and Aim Guide. See **Figure 47**.
3. The Dip Cue, Position Cue and Aim Tether are green when adding filler to the correct location of the puddle. See **Figure 47**.
4. The Dip Cue, Position Cue and Aim Tether are yellow/red when adding filler to the incorrect location of the puddle. See **Figure 47**.

Figure 47 – Filler movement

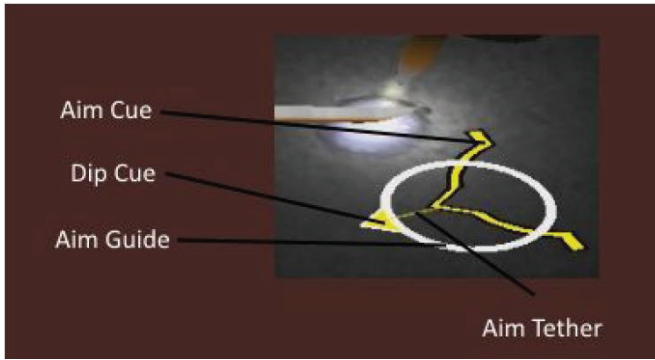
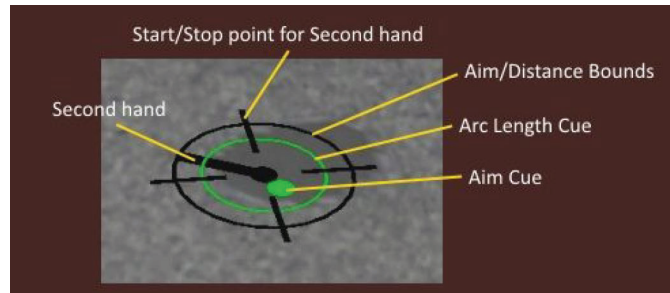

Figure 49 – Postflow



AMPERAGE

1. The footpedal location matches the real life movement of the amperage controller. See **Figure 48**.
2. Move the footpedal so the location falls within the green ideal zone. See **Figure 48**.
3. On Aluminum weld the ideal amperage range changes the longer you are welding to compensate for heating of the aluminum part. See **Figure 48**.

Figure 48 – Amperage

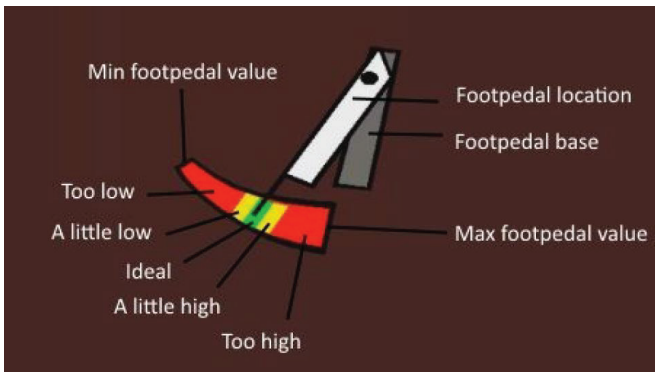

POSTFLOW

1. Only appears after breaking the arc. See **Figure 49**.
2. Maintain correct aim and arc length to keep both cues green. See **Figure 49**.
3. Wait for the second hand to do a full cycle back to the 12 o'clock position. See **Figure 49**.
4. If Arc length or Aim goes out of bounds then the post flow is failed. See **Figure 49**.

NEW COUPON

Selecting the blue new coupon menu icon replaces the current coupon with an unwelded coupon. Note that this is a quick way to start over on the same configuration and process but that it will remove all passes from the coupon and the graphs on the LASER screen. Selecting “New Coupon” will also save the previous weld to a USB stick (if attached).

WHITE SELECT ARROWS

Touching the white select arrows allow the user to rotate through the LASER screen, instructor’s view and welder’s view.

WELDER’S VIEW SCREEN

This screen shows the virtual view as seen by the user wearing the headset.

INSTRUCTOR’S VIEW SCREEN

This screen shows the coupon and virtual weld in real time. See **Figure 50**. An observer can rotate, pan and/or zoom in or out on the coupon. This view also shows the VR GMAW/FCAW gun or VR SMAW device being used.

NOTE: Changing views on the monitor does not change the user’s view in the headset.

Figure 50 – Instructors view

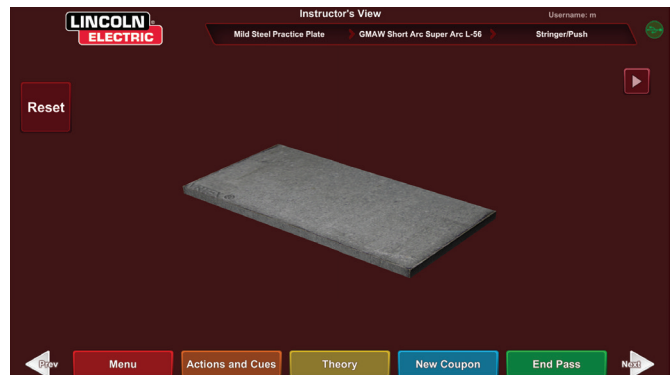

END PASS

When the user selects the green “End Pass” menu icon, the pass is scored, a snapshot of the weld is taken and the percentages of the weld containing discontinuities are calculated. **If the user has inserted a USB device, selecting “End Pass” also automatically saves a student report to the USB memory device at the front of the weld machine.**

LASER SCREEN

(Live Action Student Evaluation Report)

OVERVIEW

This screen summarizes the student’s welding performance. Detailed information about the student’s welding technique for each pass are displayed on this screen. See **Figure 51**.

TECHNIQUE PARAMETERS

The upper right area of the screen shows the technique parameters being tracked and the graph of these parameters is located to the left. See **Figure 51**. When the user welds, each parameter is graphed using a line that is of the same color as the technique parameter box. For example, “position” is written in the blue box and indicated by the blue line. The left side of the graph represents the left side of the coupon and the right side represents the right side of the coupon. For vertical welds, the graph is rotated so that it is vertical, with the bottom representing the bottom of the coupon and the top representing the top of the coupon. The graph also shows how close the parameter was to the ideal value. The ideal value is indicated by the red line located in the center of the graph. This value is determined by the tolerance editor settings. The upper and lower white lines represent the acceptable maximum and minimum values that the parameter should be within. These values are also determined by the tolerance editor setting. Anything above the top white line or below the bottom white line is out of tolerance. The closer the user is to the ideal line, the better the weld. Each parameter can be toggled on or off of the graph by touching the appropriate icon.

Figure 51 – Laser screen (graph, defects, discontinuities, etc.)

WELD EVALUATION GRAPH

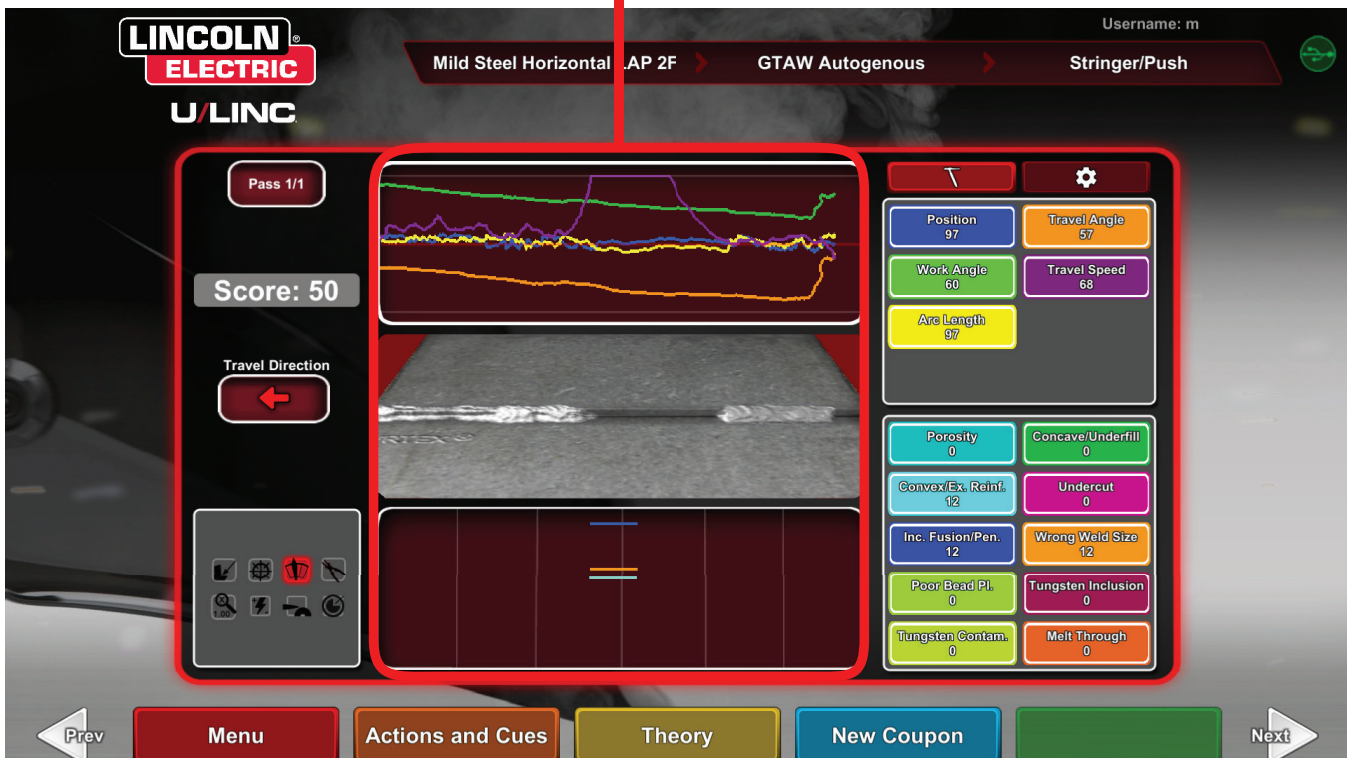

Position is the user's ideal weld root location. This location can change with each pass. When weaving, the ideal location is considered the centerline of the weave.

Contact Tip to Work Distance (CTWD) (for VR GMAW and VR FCAW) and **Arc Length** (for VR SMAW) are the distances from the tip of the VR GMAW/FCAW gun or VR SMAW device to a plane going through the ideal position location. See **Figures 52 and 53**.

Figure 52 – Contact tip to work distance (ctwd)

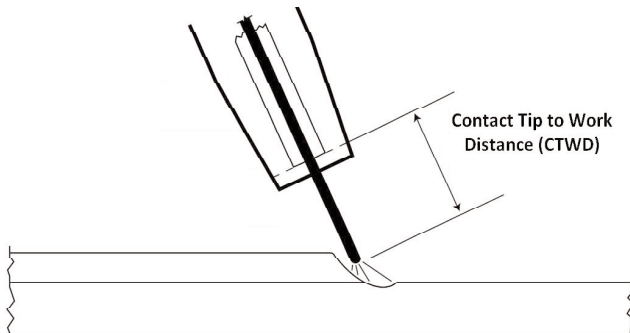
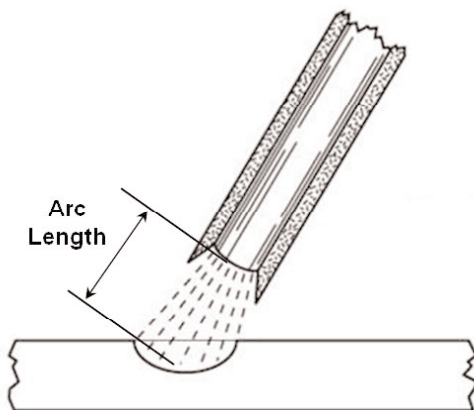
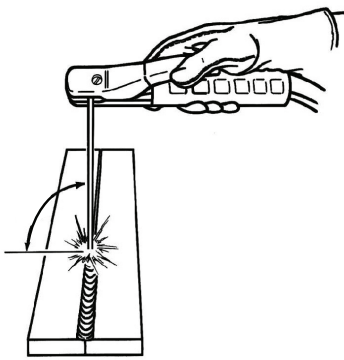

Figure 53 – Arc length



Work Angle is the angle between the electrode and workpiece as seen in **Figure 54**.

Figure 54 – Work angle



WORK ANGLE

Travel Angle is the angle between the electrode and the workpiece in the direction of travel. See **Figure 55**. The upper right area of the screen displays if the user should be pushing or dragging. If the user pushes when they should be dragging, they will not receive maximum points. For pipe welding, this is the angle between the electrode and the tangent of the pipe at that point.

Figure 55 – Travel angle

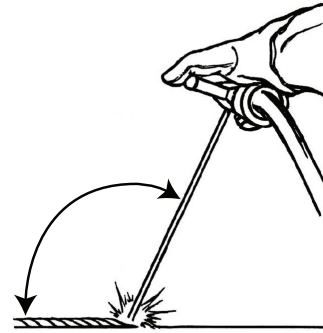

TRAVEL ANGLE

Travel Speed is how fast the electrode is traveling in respect to the workpiece.

Dime Spacing is the distance from one solidified weld puddle to the next (whip technique only).

Whip Time is the time the user is in the whipping motion or not dwelling in the weld puddle (whip technique only).

Puddle Time is the time the user is dwelling or keeping the device in the virtual puddle (whip technique only).

Width of Weave is the side-to-side distance of where the device was aimed when completing one weave cycle in a series that make up a weld (weave technique only).

Weave Timing is the time taken to complete one side to side weaving motion (weave technique only).

Weave Spacing is the distance in the overall direction of travel between one weave cycle in a series that make up a weld (weave technique only).

PASS NUMBER

The pass number is displayed on the top left corner of the screen. To change the pass being viewed touch the arrow icons.

TRAVEL DIRECTION

The travel direction is located on the left side in the middle of the screen. When the user first starts to weld, a travel direction is sensed by the system and an arrow indicating the direction is displayed. For visual cues, the system assumes these directions. The visual cues will automatically adapt to the travel direction used when the arc is struck.

BEAD RENDER

An image of the completed pass appears in the middle of the screen.

DISCONTINUITY INDICATOR

The lower right side of the screen list potential discontinuities. See **Figure 56**. When a student uses incorrect welding techniques, this causes specific weld discontinuities. A line is drawn at the location indicating these discontinuities. For example, too long an arc length will cause porosity.

Potential discontinuities include:

- Porosity
- Concave/Underfill
- Convex/Excessive Reinforcement
- Undercut
- Incomplete Fusion/Penetration
- Excess Spatter
- Wrong Weld Size
- Poor Bead Placement
- Melt Through / Blow Through
- Slag Inclusion
- Dross
- Burn Back
- Tungsten Inclusion
- Tungsten Contamination

Figure 56 – Potential discontinuities

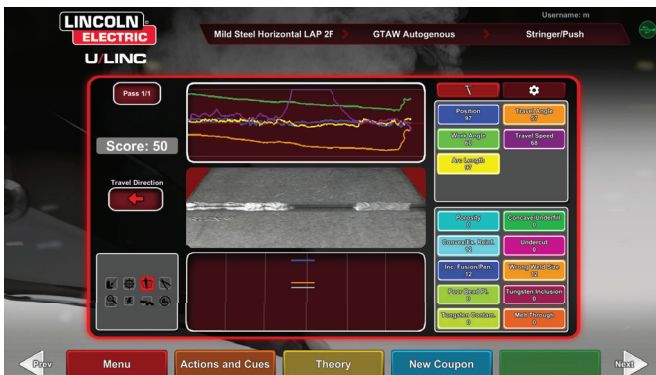

SCORE

On the upper left of the screen, a score for each parameter is calculated. The closer each parameter is to the ideal value, the higher the score will be (out of 100). The total score at the bottom of the scoring section is calculated as an average of each parameter. To achieve the maximum score, the weld must be made on the entire length of the coupon.

STUDENT REPORT

The student report is a PDF file that captures the graph, discontinuities, bead render, score and other information about the weld. See **Figure 57**. This PDF file can be printed or archived from another computer to track student progress. Example of PDF below shows student's record.

Figure 57 – Student report

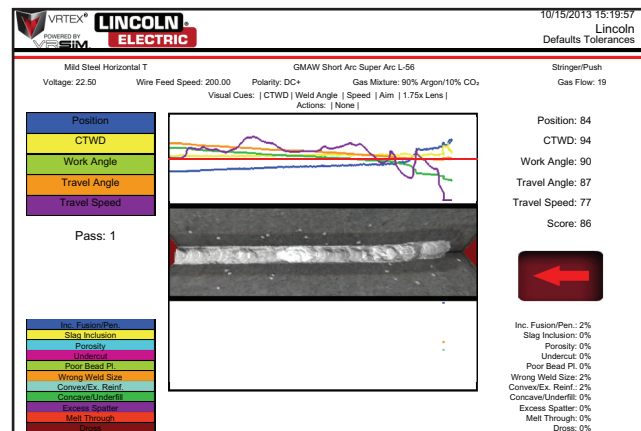

INSTRUCTOR MODE AND ADMIN ACCESS

TO ENTER INSTRUCTOR MODE

1. Touch the “Key” icon located in the lower left corner of the screen. See **Figure 58**.

Figure 58 – Menu and instruction key

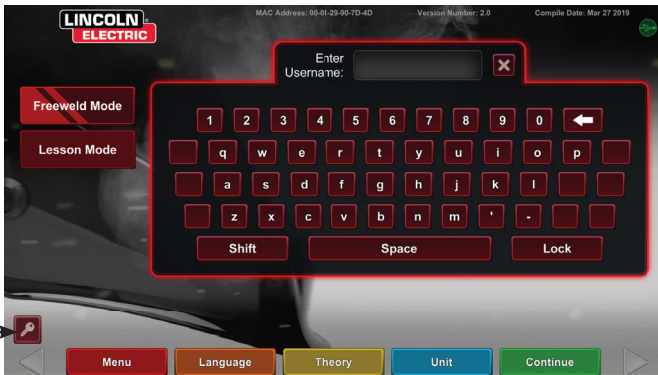

2. The default password is 1,2,3,4,5. To change the password, use the icon with the key and + sign. See **Figure 59**.

Figure 59 – Instruction entry menu

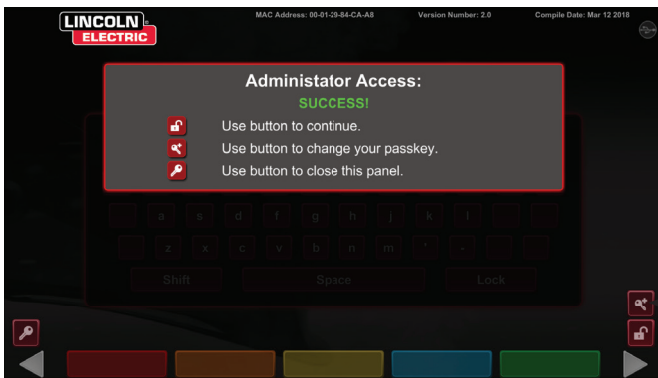

The instructor mode includes the following: See **Figure 60**.

- Weldometer
- Tolerances
- Scoring Modules
- Update
- Options
- License Info

Figure 60 – Instructors mode screen



WELDOMETER

OVERVIEW

The Weldometer tracks virtual consumables, arc time, base material and gas usage. This information can be used to track materials and cost savings incurred by the use of virtual welding training. The Weldometer tracks material usage and arc time over a “trip” (since last reset) and over the VR system’s lifetime. See **Figure 61**.

Arc Time keeps track of the amount of time (hours:min:seconds) students have a virtual arc struck with each process.

Base Metal tracks metal type and how many virtual coupons have been used and their cumulative weight. Note that plate 3/8” includes groove joints as well as T-joints, while plate 10GA. and 1/4” includes both T-joints and practice plates. Base metal screens are separated by metal type for Mild Steel, Aluminum and Stainless Steel.

Gas tracks how much virtual gas has been used.

Consumables tracks the cumulative weight of each type of virtual consumable used. It also displays how many virtual SMAW electrodes are used.

At the bottom of the screen, the **Simulated Welder Time** keeps track of how long the unit has been on (time in hours:minutes:seconds).

RESET TRIP

Selecting Reset Trip zeroes out all items in the trip column. This allows an instructor to track VR material savings over a certain time period.

SAVE TO FILE

If a USB memory device is inserted in the unit, selecting “save to file” saves a file with all of the current Weldometer information in a text format. Once the file has saved, the user can take the USB to a computer or printer to print, email, copy, store or view the file.

Figure 61 – Weldometer



TOLERANCE EDITOR

OVERVIEW

The tolerance editor allows users to modify the system settings from the default to fit their curriculum. See **Figure 62**.

The VRTEX ships with Lincoln “default” welding parameters pre-installed. New parameters can be created by the instructor to reflect a specific welding application or technique.

NOTE: Default parameters cannot be modified.

Figure 62 – Tolerances



This tolerance editor affects the file currently being shown in the “choose tolerance setup” window.

Selecting **Create New** creates a new file on the unit. The file starts with the default settings. Selecting this icon takes the user to a keyboard screen so that a new file name can be entered.

Selecting **Rename** brings the user to a keyboard screen where the name of the current file can be changed.

Selecting **Copy** makes a copy of the file currently being shown on the choose tolerance setup window. The copy is identified with the same name plus an incremented number after it.

Selecting **Save to USB** saves the current file to a USB memory device, if a USB memory device is inserted in the front of the machine.

Selecting **Customize** allows the instructor to adjust various tolerances to the desired level.

Selecting **Delete** erases the file currently shown.

CAUTION

Changing the settings in the tolerance editor will dramatically affect how the system runs, including scoring, visual cues and discontinuities. Take care in changing the settings of the tolerance editor as not to reflect unrealistic welding situations.

CHOOSE TOLERANCE SETUP

Displays the list of all tolerance settings currently stored on the unit. All units ship with default settings. If the user creates multiple tolerance files, the file in use is selected by using the red arrow icons. This affects the visual cues, graphs, discontinuities and score. The current tolerance settings in use are also listed on this screen.

CHOOSE TOLERANCE TO LOAD

This displays the list of all tolerance sets currently stored on the USB device. Files can be transferred to and from a VRTEX with a USB memory device.

CUSTOMIZE TOLERANCE LEVELS

The following steps describe the procedure to change tolerances for the VRTEX:

1. Select **Tolerances**.
2. Select **Create New**.
3. Enter a new tolerance name on the keyboard screen.
4. Select **Continue**.
5. Scroll through “Choose Tolerance Setup” menu to display the desired tolerance.
6. Select the **Select Tolerance** icon when the desired name is displayed in the field.

NOTE: When desired tolerance name is properly selected, that name will be displayed at the top of the screen next to “Current Tolerance”.

7. Select “Customize”.
8. The user selects which configuration to modify. See **Figure 63**.

Figure 63 – Joint configuration selection screen

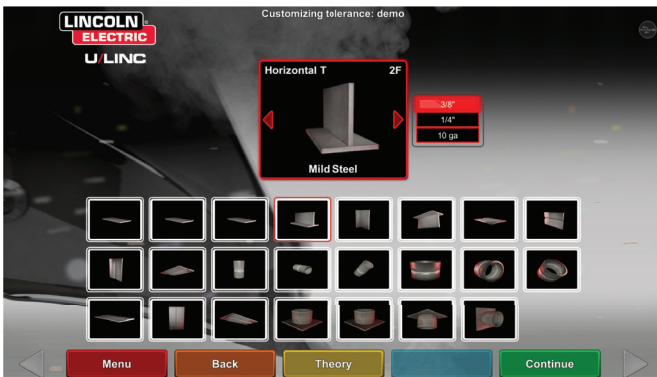

9. The user selects which process to modify. See **Figure 64**.

Figure 64 – Process selection screen

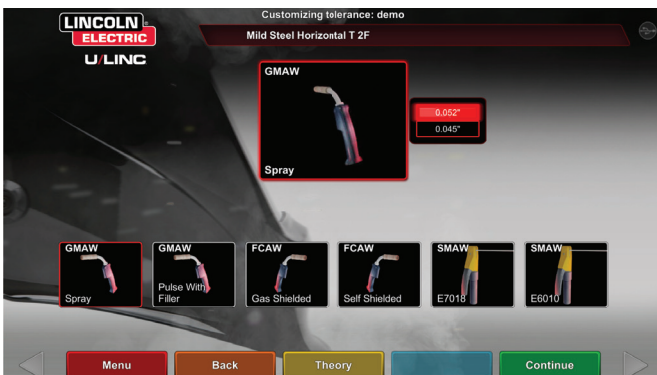

10. The equipment settings screen allows for the modification of the following welding parameters (See **Figure 65**):

- Wire Feed Speed
- Amperage
- Voltage
- Polarity

Figure 65 – Equipment settings screen

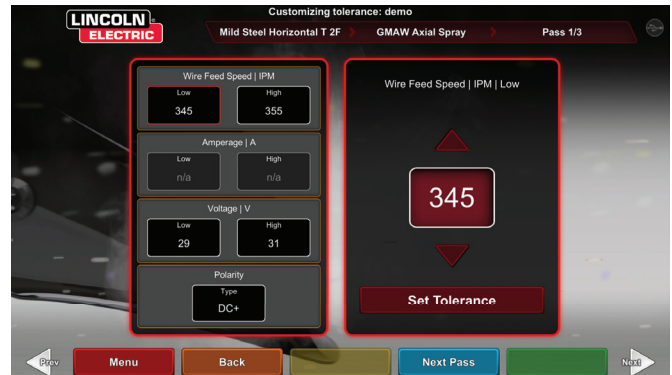

11. The gas screen allows for the modification of the following welding parameters (See **Figure 66**):

- Gas Mixture Selected
- Gas Flow Rate
- Preflow
- Postflow

Figure 66 – Gas screen

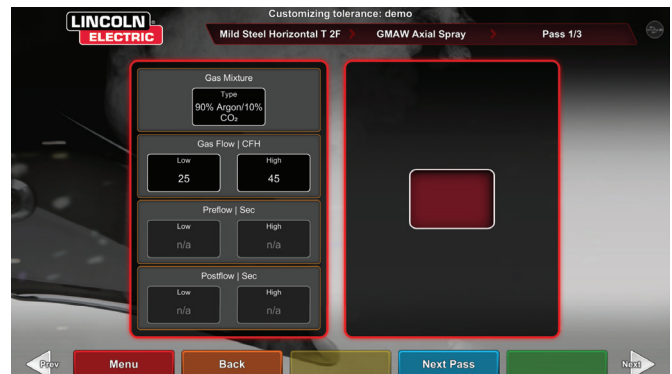

12. The welding technique parameters screen allows the modification of (See **Figure 67**):

- CTWD/Arc Length
- Work Angle
- Travel Angle

Figure 67 – Welding technique parameters screen

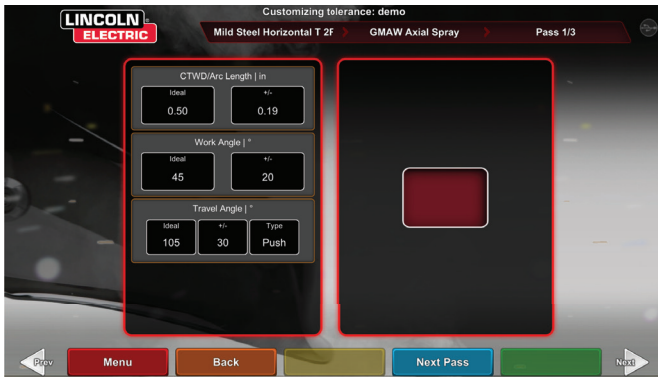

NOTE: The travel angle for drag welding techniques should always be less than 90 degrees. The travel angle for pushing technique should always be greater than 90 degrees.

13. The pattern & aim screen allows the user to change the type of pattern being used (stringer, box weave, straight weave, whip, triangle weave) and the position of the root of the weld. See **Figure 68**. The X and Y values change the location of where the weld bead should be placed. See **Figure 69**. This affects the position parameter on the Live Action Student Evaluation Report (LASER) screen. The +/- determines how far off from the ideal position the student can place the electrode before it results in a misplaced weld.

Figure 68 – Pattern & aim screen



Figure 69 – Coordinate chart for weld placement (position)

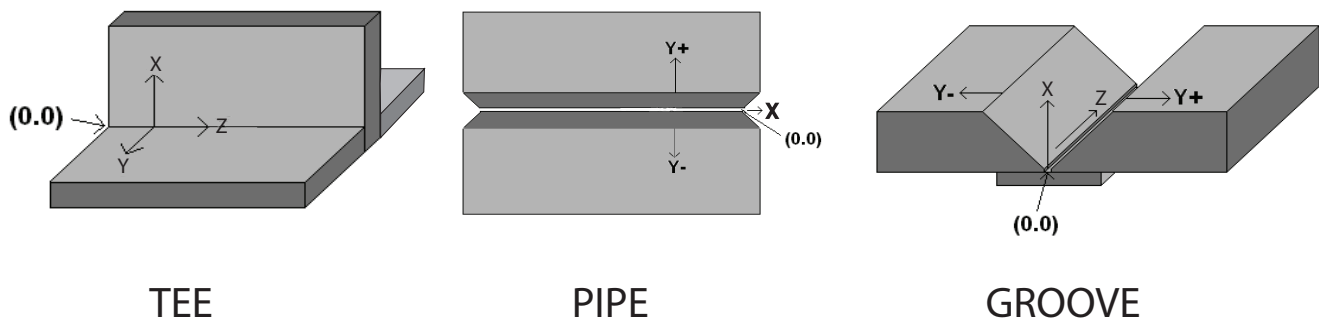

14. The whip & travel screen allows for the modification of technique parameters relating to the whipping welding technique and travel speed including (See **Figure 70**):

- Dime Spacing
- Whip Time
- Puddle Time
- Travel Speed

Figure 70 – Whip & travel screen

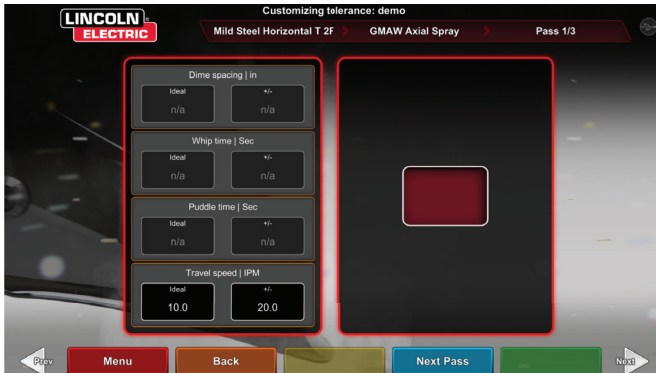

15. The weave screen allows for the modification of weaving welding technique including (See **Figure 71**):

- Width of Weave
- Weave Timing
- Weave Spacing

Figure 71 – Weave screen



SCORING MODULES

After welding a pass, the user can now see whether each defect/discontinuity was within acceptable standards (passed) or not (failed). The acceptable standards implemented in VRTEX are known as scoring modules. Instructors can enable the scoring module they would like to use (i.e., AWS D1.1 or ASME). The pass/fail marks will appear on the LASER screen for relevant passes (scoring modules do not cover all of the available VRTEX welds).

The SCORING MODULE feature can be used when the user wishes to have their welding evaluated against the ASME or AWS D1.1 standards. Select the SCORING MODULES icon and use the red arrows to toggle between scoring based on ASME standards, D1.1 standards, and None.

Figure 72 – Scoring Modules

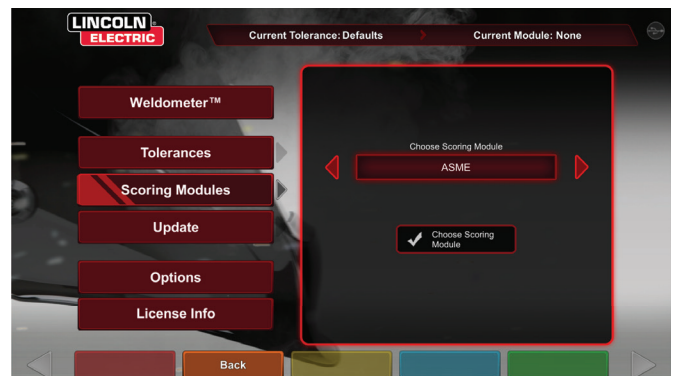

UPDATE

OVERVIEW

The update screen in the instructor mode allows the user to update their software or to update specific configuration files from the USB memory device in the front of the VRTEX. Selecting this brings up two options (See **Figure 73**):

- Update Software
- Update Configuration File

Figure 73 – Update

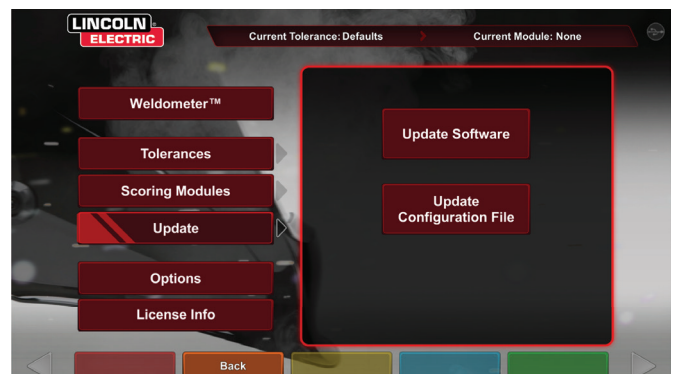

SOFTWARE

Selecting this option loads a newer version of the software if one is available on a USB inserted in the front of the machine. Updating to a different version may shut down or restart the system.

After updating, the system may need to be shut down and restarted for changes to be implemented.

CONFIGURATION FILE

Selecting this option loads any configuration changes from the USB inserted in the front of the machine. This is used for part replacement.

OPTIONS

The options screen, in the instructor mode, allows the user to change the volume of the user interface and welding sounds, date and time settings and sensor settings (magnetic frequency ID). See **Figure 74**. The options screen also allows the user to view the status of any connected devices. Selecting the yellow DEVICE STATUS icon will display the connection status of each device. Properly connected devices will display a green checkmark and improperly or not connected devices will be displayed with a red X. See **Figure 75**.

Figure 74 – Options

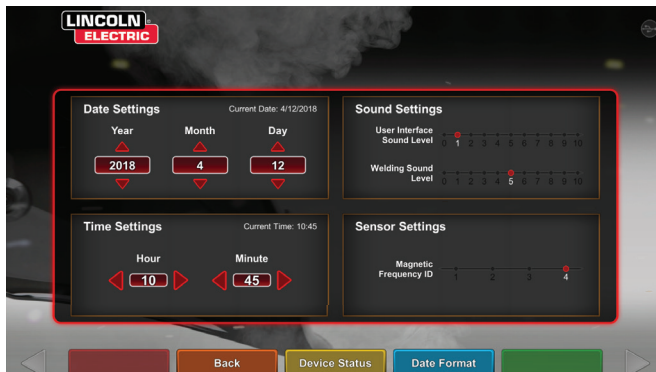
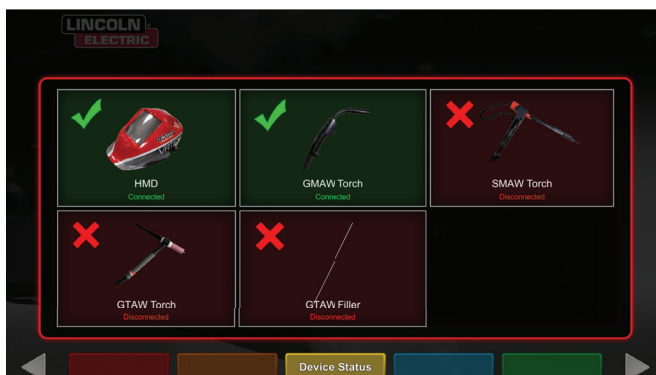

Figure 75 – Device status



ADDITIONAL FEATURES

BEND TEST

Many welding codes require bend tests as part of the testing required to qualify welders according to welding procedures specifications (WPS's). By adding the virtual bend test to the VRTEX, a student can see what causes a bend test to pass and fail. This functionality also enhances the instructor tool set by reinforcing classroom instruction and allows students to pass and fail in a virtual environment before entering a real welding booth, saving both time and money.

The virtual bend test certificate serves as recognition of a student's achievement on a certain level in training. The bend test certificate also adds motivation for the students in their welding training program.

The BEND TEST application has been implemented to allow the user to see the results of their weld by simulating the destructive testing method used in many shops and schools called the Bend Test. The virtual bend test gives the user instant results of the quality of their weld by bending the weld 180°. Once the user completes a groove or pipe weld the BEND TEST option appears in the same location as the green CONTINUE icon. The user can select this option by pressing the green BEND TEST icon once the weld is completed.

NOTE: Fillet welds cannot be bent on the VRTEX 360.

Figure 76 – Bend test

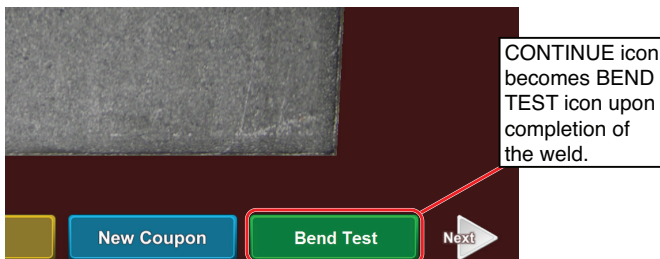

SELECTING SAMPLES TO BEND

Select the A or B sample to bend.

Figure 77 – Sample A



Figure 78 – Sample B

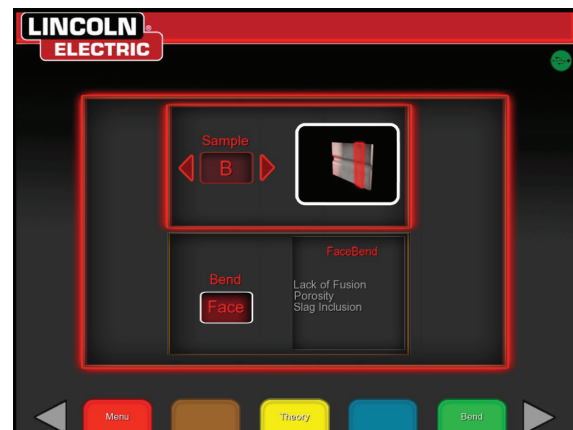

SELECTING ROOT OR FACE

Select the direction of the bend to the ROOT or FACE. Once the desired sample is chosen, press the green BEND icon to begin the bend test.

Figure 79 – Root



Figure 80 – Face



Once the first sample has been bent, use the white NEXT or PREV arrow to select the next tab to bend.

Figure 81 – Green to bend

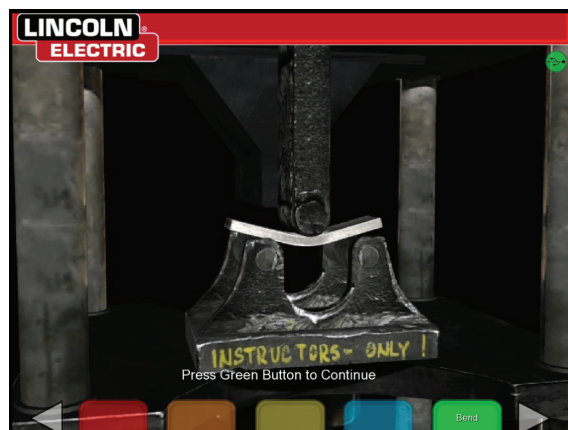
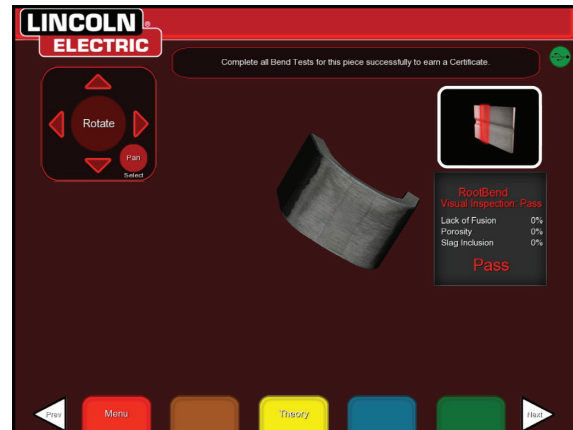

Figure 82 – Completed bend test



BEND TEST FAILURE

The VRTEX will visually inspect the weld before allowing it to be bent. If the weld passes the visual inspection, the user can move proceed with the bend test. If a weld fails the bend test, the details such as a percentage of failure will be displayed in the information box on the right side of the screen. The weld failure is measured in three different aspects including Lack of Fusion, Porosity, and Slag Inclusion. If the user fails the bend test there will not be a virtual bend test certificate in the student report.

Figure 83 – Failed



Figure 84 – Completed bend test

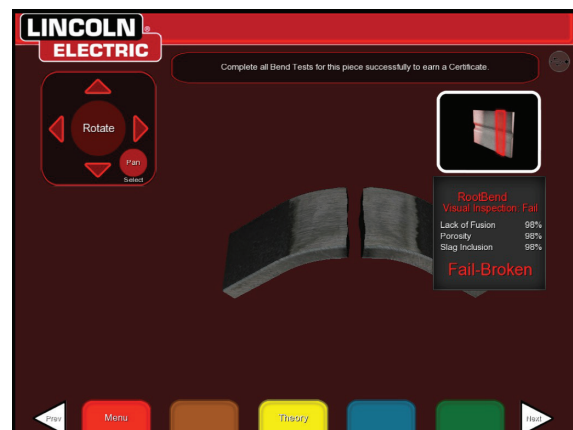

THE CERTIFICATE

The BEND TEST CERTIFICATE is located in the STUDENT REPORT, which can be saved and accessed if there is a USB memory device in the USB slot on the front of the VRTEX while performing the virtual bend test procedure.

Figure 85 – Bend test certificate

TYPE	RESULT	REMARK
Pass Band B	Subsatisfactory	No Defects

REPLAY MODE

The Video Replay feature in your VRTEX provides the ability to view your virtual weld video once you have completed it. This feature offers students and instructors the ability to refine skills by replaying the weld performed from the different viewing angles and discussing technique.

Figure 86 – Replay mode



SCORING MODULES - EVALUATE AGAINST ASME / AWS D1.1

The SCORING MODULE feature can be used when the user wishes to have their welding evaluated against the ASME or AWS D1.1 standards. This option can be selected by entering the INSTRUCTORS MODE. The only screen the Instructors Mode can be accessed from is the Sign In screen. Select the SCORING MODULE located at the bottom right corner of the Instructors Mode screen. Toggle between Based on ASME Standards, Based on D1.1 Standards, and None. Press the orange BACK icon twice to return to the Sign In screen.

ALUMINUM WELDING SIMULATION

The Aluminum GMAW feature in your VRTEX allows the system to simulate the look, sound, discontinuities, equipment settings and Theory definitions for the Aluminum GMAW process. Aluminum GMAW simulates Pulse and Spray welding on tee joints (2F and 3F) and groove (1G, 2G and 3G) on 3/8" and 10 gage material. The electrode of choice for this training is the SuperGlaze™ 4043 electrode and the base material is 6061 grade aluminum.

STAINLESS STEEL WELDING SIMULATION

The Stainless GMAW feature in your VRTEX allows the system to simulate the look, sound, discontinuities, equipment settings and Theory definitions for Stainless GMAW. Stainless GMAW simulates Pulse and Spray welding on tee joints (2F and 3F) and groove (1G and 3G). For more information on how to operate the Stainless GMAW feature, visit: www.vrtex.com for the latest instruction manual. The electrode of choice for this training is the Blue Max™ 308L Si electrode and the base material is 308 grade stainless steel.

DEMO WELD MODE

The Demo Weld feature in your VRTEX provides an example of the virtual weld you have selected. By selecting and viewing this virtual weld, you can see the suggested technique on how to successfully make the chosen weld.

Figure 87



LEARNING LEVELS

The Learning Levels, or Tolerance Level, feature in your VRTEX provides 3 skill levels (Entry Level, Intermediate and Advanced) for students. As the progression of skills and capabilities progress, you can enable different levels to keep students challenged, excited and engaged in learning.

DEFAULT

The “Default” settings are the original settings created for the VRTEX program. They are a general setting used to teach the user the proper welding angles, distances and motions. See the Operators Manual provided with the unit for further information.

ENTRY LEVEL

The “Entry Level” Learning Level is designed to train the Entry Level welder. The tolerance settings are slightly easier to allow the beginner to become familiar with the welding motions. They are slightly more challenging than the “Default” settings but teach the same general techniques.

INTERMEDIATE

The “Intermediate” Learning Level is designed to be more challenging than the “Entry Level” setting. This level is for the student with some welding experience.

ADVANCED

The “Advanced” Learning Level is designed to be the most challenging. This level is for the student that has more welding experience. This level is the most challenging and hardest level to score well in. The tolerances are set very close forcing the user to almost perfect the angles, distance and motion of the welds.

Figure 88 – Advanced tolerance selection



ACCESSING THE LEARNING LEVELS

From the Sign In screen, enter the Instructors Mode. Once in the Instructors Mode highlight the Tolerance block and Select the tolerance. The Tolerance Selection Box will appear below the Tolerance block. Toggle left or right through the available Learning Levels. The tolerance files are in alphabetical order.

SELECTING A LEARNING LEVEL

Once Tolerance has been selected, toggle between the different Learning Levels. In the Tolerance Selection Box there will be four options that have an image of a lock next to them. The lock indicates the tolerance cannot be changed. The four tolerances are Default, Entry Level, Intermediate and Advanced. Select the tolerance to activate the Learning Level desired. Upon selection, a prompt box will appear asking if the selection is the intended tolerance level desired. Select the tolerance again and the change will be made.

Any additional tolerance settings that have been created by the user will also appear in this box. Those tolerance settings can still be accessed and changed as the user deems necessary. The Learning Levels are designed to teach student progression starting with the Entry Level and progressing through the Intermediate and Advanced levels until they become proficient with the welding movements.

EXITING THE LEARNING LEVELS

Once the user has chosen the desired Learning Level, press the orange Back icon two times to exit the tolerance and Instructors Mode. This will take the program back to the Sign In screen. Follow the setup procedures to begin the learning experience.

RESTARTS

The “Restart” or “Tie-In” is a technique that should be mastered. The ability to stop and restart as a welder creates a bead that not only can affect the appearance of the weld, but also the integrity of the weld. The Restart cues and Restart scoring will allow the user to practice and evaluate this technique.

Figure 89



SELECTING A COUPON FOR RESTARTS

The general set up is the same as setting up for the other joints. The user signs in on the “Login” screen and presses the green continue button. This will take the user to the “Joint Selection” screen. There are two coupons that can be used for practicing Restarts: Practice Plate and Pipe on Plate.

Figure 90

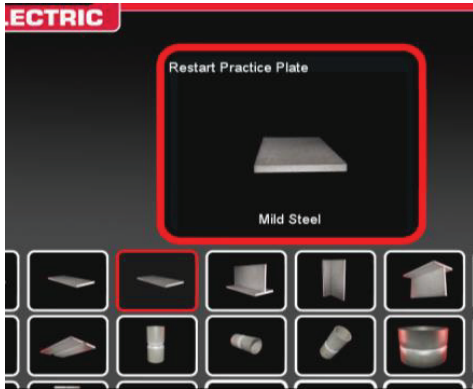

Once the desired coupon is selected then select the desired process (Short Circuit GMAW or 7018 SMAW). Follow the normal coupon setup process. The coupon will appear as a partial completed weld bead with a small gap. The student will choose either end as the starting point to restart and fill the gap.

Figure 91

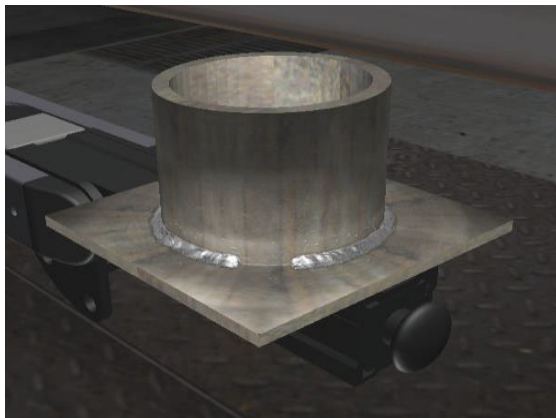

VISUAL CUES FOR RESTARTS

Prior to creating the weld access the visual cue for Restarts by pressing the orange Action and Cues. Find and select “Restart”.

Figure 92

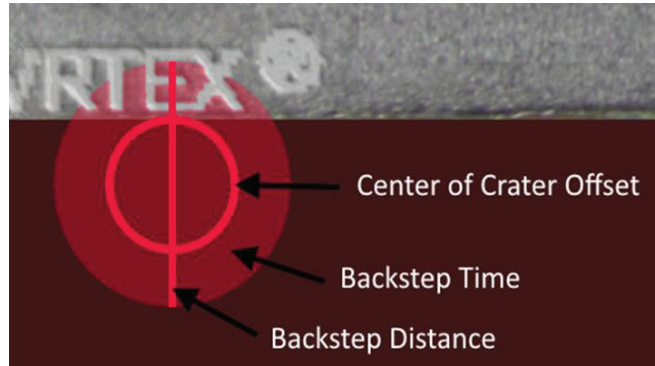

Once the weld device is close to the starting position a circle will appear. The color of the circle cue indicates the distance from the center of the crater to the starting position. Red is out of the control limits and would produce a red scoring rectangle on the LASER chart. A green circle is considered an acceptable starting position.

The backstep distance is measured from the start position. A straight line thru the circle is the cue. A green line is acceptable, red would be out of the control limits.

Backstep time is measured by the amount of fill in the circle. Red fill can be the result of too much time (fill outside of the circle) or too little time (does not fill to the edge of the circle). Green is acceptable.

SCORING RESTARTS

A green rectangular block on the chart for the backstep portion of the weld is considered a passing Restart. A red block would indicate the Restart parameters exceeded the control limits.

Figure 93

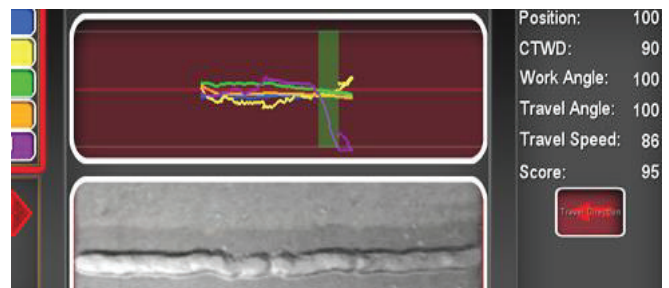

The LASER screen scores reflect each of the individual parameters for the students portion of the completed bead.

CLEANING & MAINTENANCE

ROUTINE MAINTENANCE

Routine maintenance on the VRTEX should be performed on an as needed basis dependent on machine usage and environment. The coupons should be cleaned with a soft cloth if they become dusty or dirty. Inspect cables for cracks or other heat related issues, replace as necessary.

HEADSET

Taking proper care of the headset is important for optimal functioning of the equipment. Occasionally, the headset lens should be wiped with the lint free lens wipe that is provided. This can be done to remove fingerprints from the lenses. You can also use a lens cloth (e.g., from a camera shop). Paper towels or household cloths may scratch or damage the lenses and should not be used. Avoid exposing the headset to liquids. Cleaning solutions should not be used to clean the headset. Do not use Isopropyl alcohol or solutions containing alcohol to clean the lenses or plastic parts on the headset. You can also use a camera pressure canister to occasionally blow out dirt.

You may want to clean the inside of the headset occasionally. Be sure to do so without exposing the headset to any unacceptable materials, as explained above.

The headset should be kept in a clean and dry location out of direct sunlight. Avoid dirty or sandy environments, as these can lead to scratching of optics and damage the headset mechanical adjustments.

TOUCHSCREEN MONITOR



Use care when cleaning screen. Use only a soft dry cloth (cotton or flannel). Avoid chemicals and solvents (alcohol, benzine, acidic or alcazine solvent cleaners). Avoid granular or abrasive cleaning agents.

BATTERY

The backup batteries (two for each computer unit) are located behind the access panel on the rear of the machine. See Figures 110 and 111. The “AA” backup batteries can be accessed by using a T-30 torx nutdriver to remove the two screws and the panel. The machine must be powered ON when changing the backup batteries. The batteries should be replaced once a year. These batteries are required to keep the date and time settings and several startup parameters in the computer. If these settings are lost contact a service representative for assistance.

Figure 94

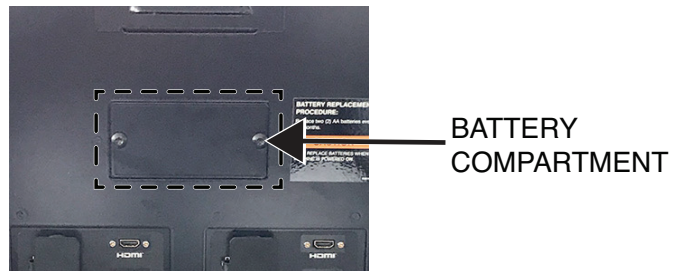
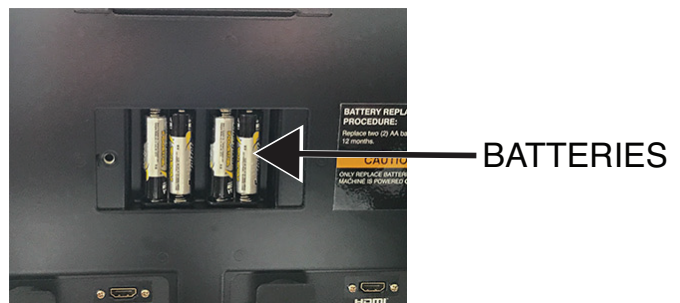

Figure 95



HOW TO USE TROUBLESHOOTING GUIDE

WARNING

Service and Repair should only be performed by Lincoln Electric Factory Trained Personnel. Unauthorized repairs performed on this equipment may result in danger to the technician and machine operator and will invalidate your factory warranty. For your safety and to avoid Electrical Shock, please observe all safety notes and precautions detailed throughout this manual.

This Troubleshooting Guide is provided to help you locate and repair possible machine malfunctions. Simply follow the three-step procedure listed below.

Step 1. LOCATE PROBLEM (SYMPTOM).

Look under the column labeled “PROBLEM (SYMPTOMS)”. This column describes possible symptoms that the machine may exhibit. Find the listing that best describes the symptom that the machine is exhibiting.

Step 2. POSSIBLE CAUSE.

The second column labeled “POSSIBLE CAUSE” lists the obvious external possibilities that may contribute to the machine symptom.

Step 3. RECOMMENDED COURSE OF ACTION

This column provides a course of action for the Possible Cause.

If you do not understand or are unable to perform the Recommended Course of Action safely, contact your local Lincoln Authorized Field Service Facility.

CAUTION

If for any reason you do not understand the test procedures or are unable to perform the tests/repairs safely, contact your **Local Lincoln Authorized Field Service Facility** for technical troubleshooting assistance before you proceed.

Observe Safety Guidelines detailed in the beginning of this manual.

TROUBLESHOOTING GUIDE

PROBLEMS (SYMPTOMS)	POSSIBLE AREAS OF MISADJUSTMENT(S)	RECOMMENDED COURSE OF ACTION
There is jitter, shake or wobble in the Headset display and Monitor.	The headset is too far from the work piece. The further the headset is from the work piece the more jitter there may be in the headset display.	Move headset closer to work piece. Check for loose or faulty connections between the Headset/Monitor and the VRTEX machine. See the Wiring Diagram.
	Local interference such as fluorescent light, large metallic objects and/or high frequencies.	Make sure there are no objects or frequencies that are interfering with the system. See the Installation section.
The weld coupon image is a different configuration than the physical coupon.	Either the wrong coupon is on the stand or the wrong configuration has been selected.	Select the menu icon and select 'change coupon type'. Change the software selections so that the images on the screen match the hardware you are using.
When check settings is activated, the incorrect settings appear.	The settings in the Instructor Mode are incorrect.	Make sure all of the settings in the tolerance editor are correct for the process and parameters being used. Check for the acceptable ranges for the Lincoln defaults.
The students' reports are not accessible.	USB storage device not in front of machine.	The students' reports can only be saved via the USB port on the front of the VRTEX. Plug in a USB memory device into the front of the machine. If a USB memory stick is not plugged into the USB port or if there is no available memory on the USB stick, the students' reports will not be saved.
The welding device will not strike an arc.	Check to make certain the coupon is positioned correctly and the student is attempting to weld the correct side of the coupon.	VR weld the other side of the VR coupon. Make certain the VRTEX 360 logo on the VR coupon appear on the monitor and in the VR headset.

CAUTION

If for any reason you do not understand the test procedures or are unable to perform the tests/repairs safely, contact the Lincoln Electric Automation Department for technical troubleshooting assistance before you proceed. Call 1-888-935-3878.

Observe Safety Guidelines detailed in the beginning of this manual.

TROUBLESHOOTING GUIDE

PROBLEMS (SYMPTOMS)	POSSIBLE AREAS OF MISADJUSTMENT(S)	RECOMMENDED COURSE OF ACTION
Previous weld pass data is not accessible on the LASER screen.	“End Pass” must be activated before starting a new pass. If a new coupon is started the data will only be available for the first pass. Again; “End Pass” must be selected before a new pass is started.	Use the touch screen to go to pass number and change which pass data you are looking for. Note that some configurations only have one pass capabilities. See the Lincoln default tolerances.
The user is not sure of which tolerance set they are using.	The current tolerance is listed at the top of the screen in the Instructor Mode.	Go to the instructor mode to change tolerances. Go to the login screen, select the key icon, enter pass code and select tolerances to verify tolerance set. See the Operation section.
The welding device(s) location does not correspond with the image shown in the headset.	The system may be located near large metal objects.	Move the system to a suitable location. See the Installation section.
The VRTEX does not start up when the power button is pressed.	Make sure the correct input power is being applied to the machine. Verify fused power switch is in the ON position. Fuse may be faulty. Circuit breaker may be tripped.	Replace with 10A/250V fuse only. Reset and tripped circuit breaker.
Welding device does not appear in the joint properly.	Wrong toolset reference number plugged into machine.	Match toolset reference number on device to number on front of machine. Also ensure coupon arm is the correct toolset number.
No sound.	Volume turned down in software.	To increase the volume reference the ‘Instructor Mode’ and ‘Options’ section.

CAUTION

If for any reason you do not understand the test procedures or are unable to perform the tests/repairs safely, contact the Lincoln Electric Automation Department for technical troubleshooting assistance before you proceed. Call 1-888-935-3878.

Figure 96 – Dimensions

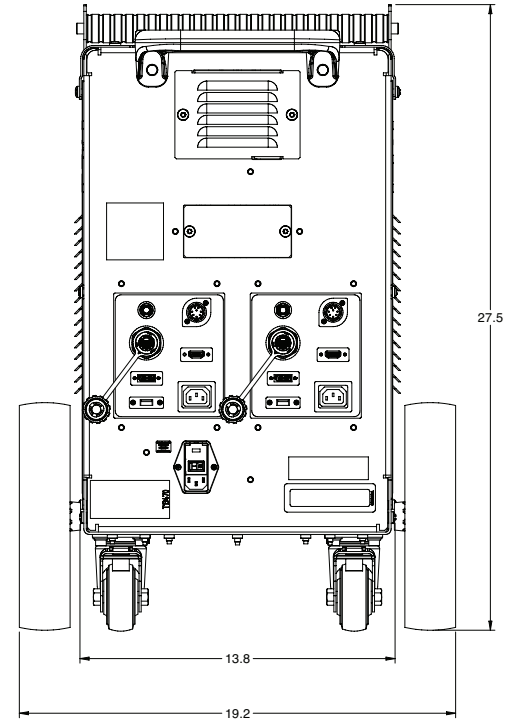
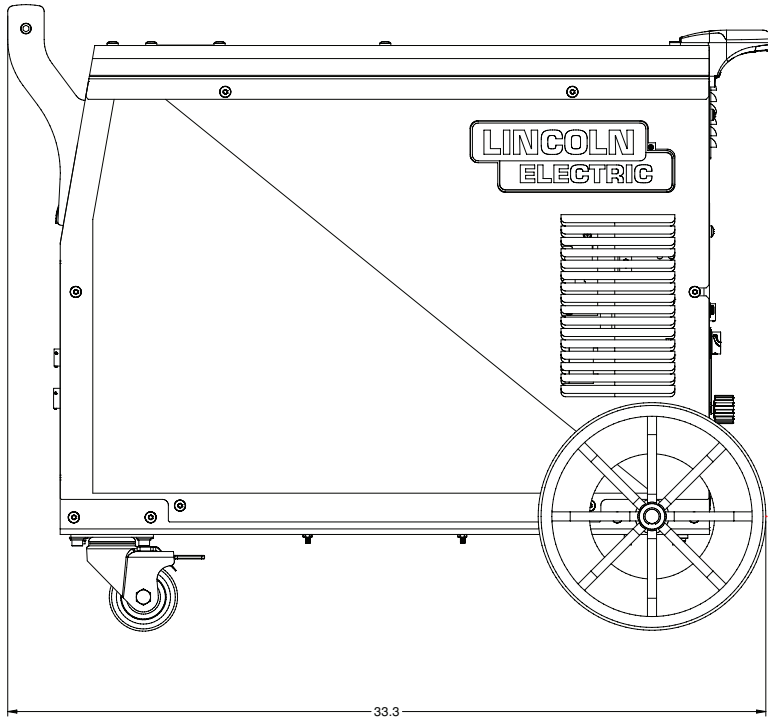
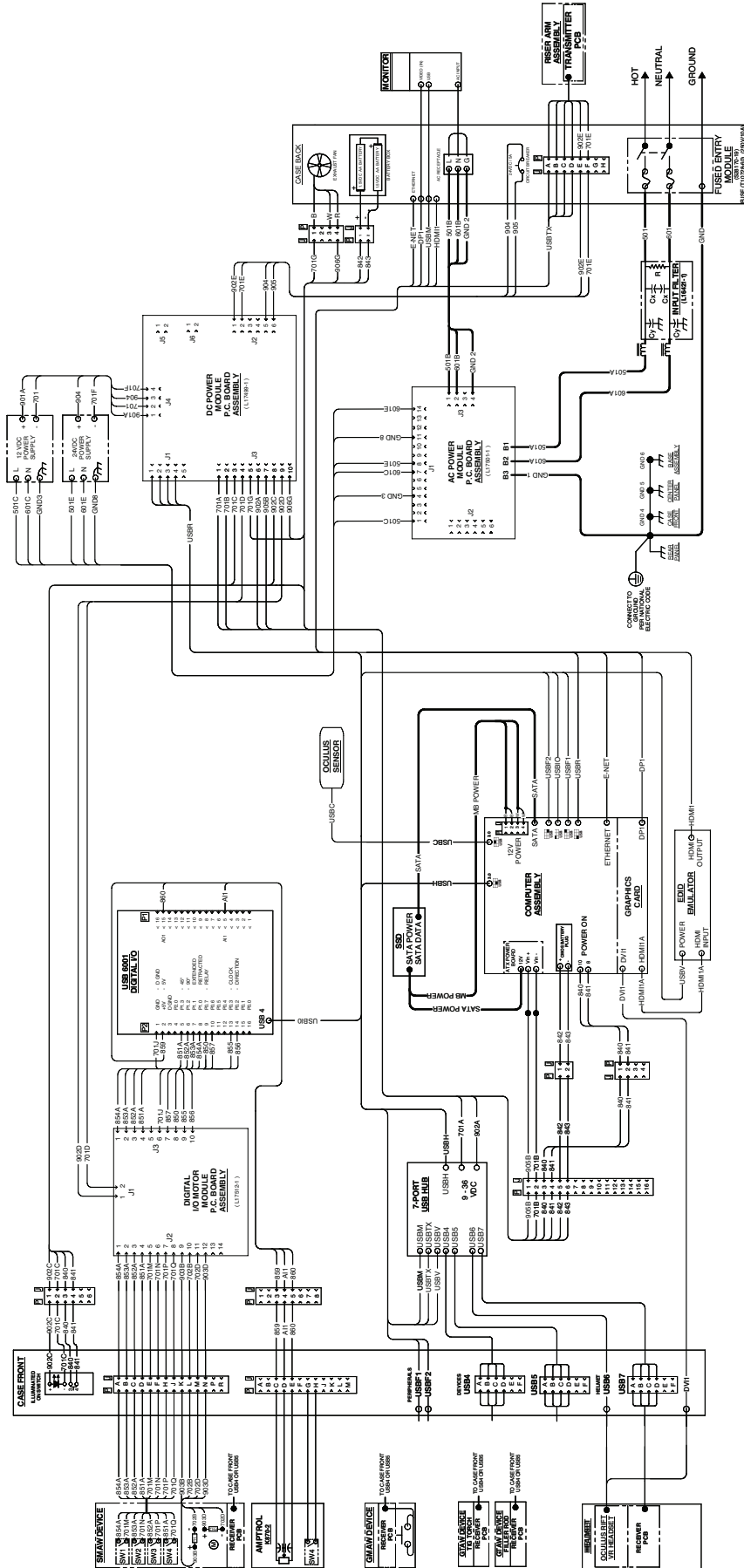

Figure 97 – Wiring diagram

K4601-1 VRTEX 360 - Wiring diagram



SINGLE USER

NOTE: This diagram is for reference only. It may not be accurate for all machines covered by this manual. The specific diagram for a particular code is pasted inside the machine on one of the enclosure panels. If the diagram is illegible, contact the service department for a replacement. Give the equipment code number.

K4602-1 VRTEX 360+ - Wiring diagram

Figure 98 – Wiring diagram

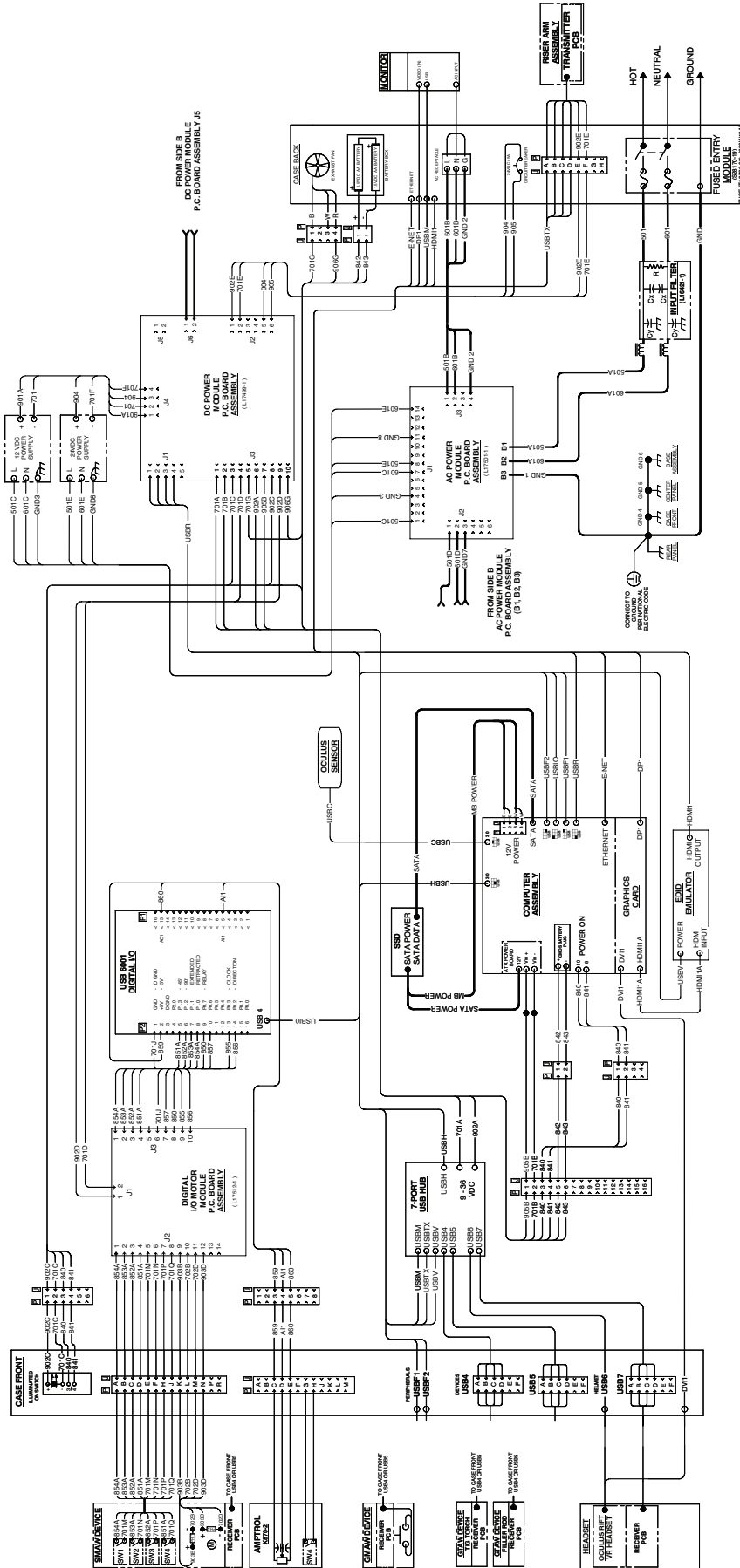

DUAL USER SIDE A

NOTE: This diagram is for reference only. It may not be accurate for all machines covered by this manual. The specific diagram for a particular code is pasted inside the machine on one of the enclosure panels. If the diagram is illegible, contact the service department for a replacement. Give the equipment code number.

K4602-1 VRTEX 360+ - Wiring diagram

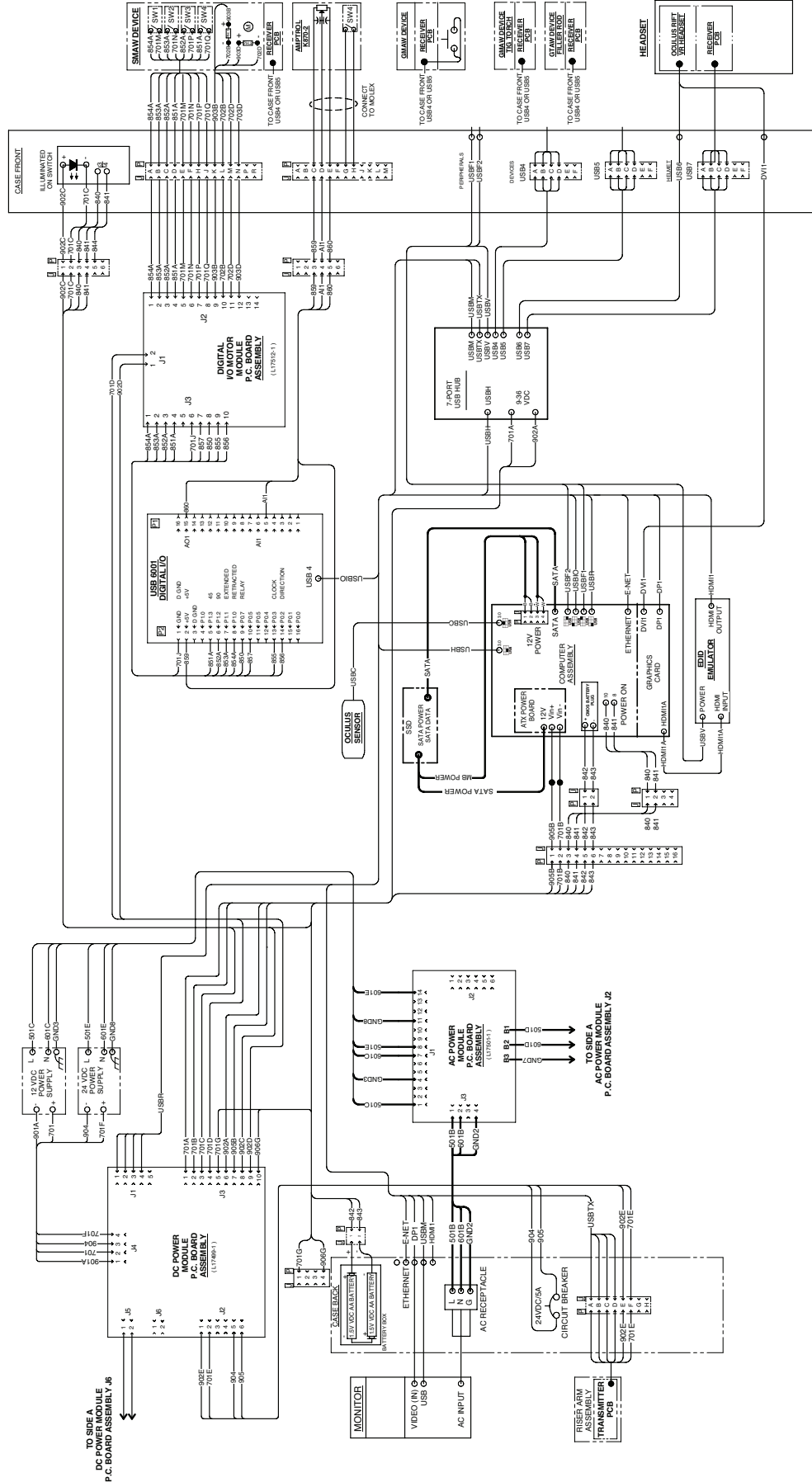

Figure 99 – Wiring diagram

DUAL USER
SIDE B

NOTE: This diagram is for reference only. It may not be accurate for all machines covered by this manual. The specific diagram for a particular code is pasted inside the machine on one of the enclosure panels. If the diagram is illegible, contact the service department for a replacement. Give the equipment code number.

K4603-1 VRTEX Transport - Wiring diagram

Figure 100 – Wiring diagram

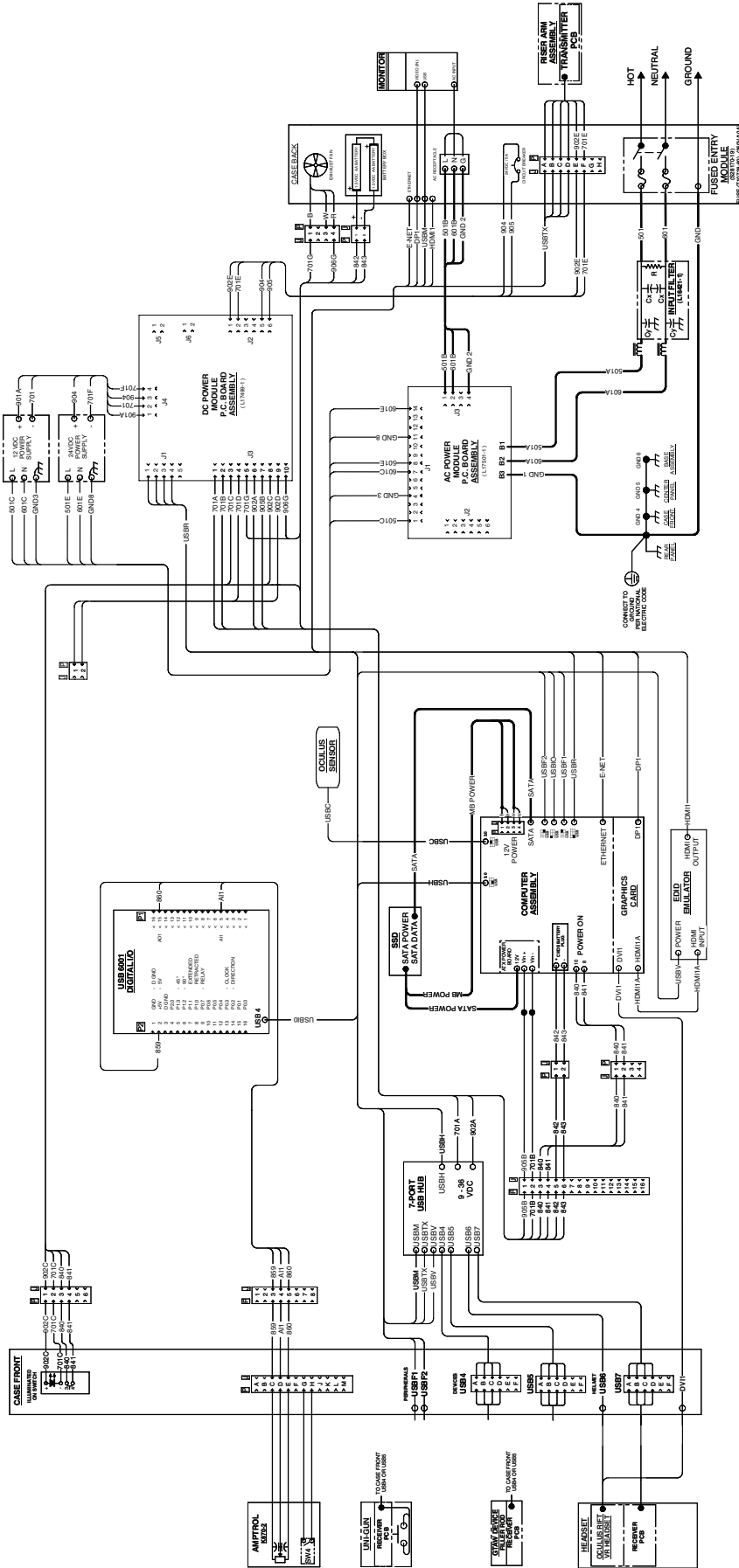

TRANSPORT

NOTE: This diagram is for reference only. It may not be accurate for all machines covered by this manual. The specific diagram for a particular code is pasted inside the machine on one of the enclosure panels. If the diagram is illegible, contact the service department for a replacement. Give the equipment code number.

Figure 101 – Wiring diagram

K4633-1 VRTEX Transport+ - Wiring diagram

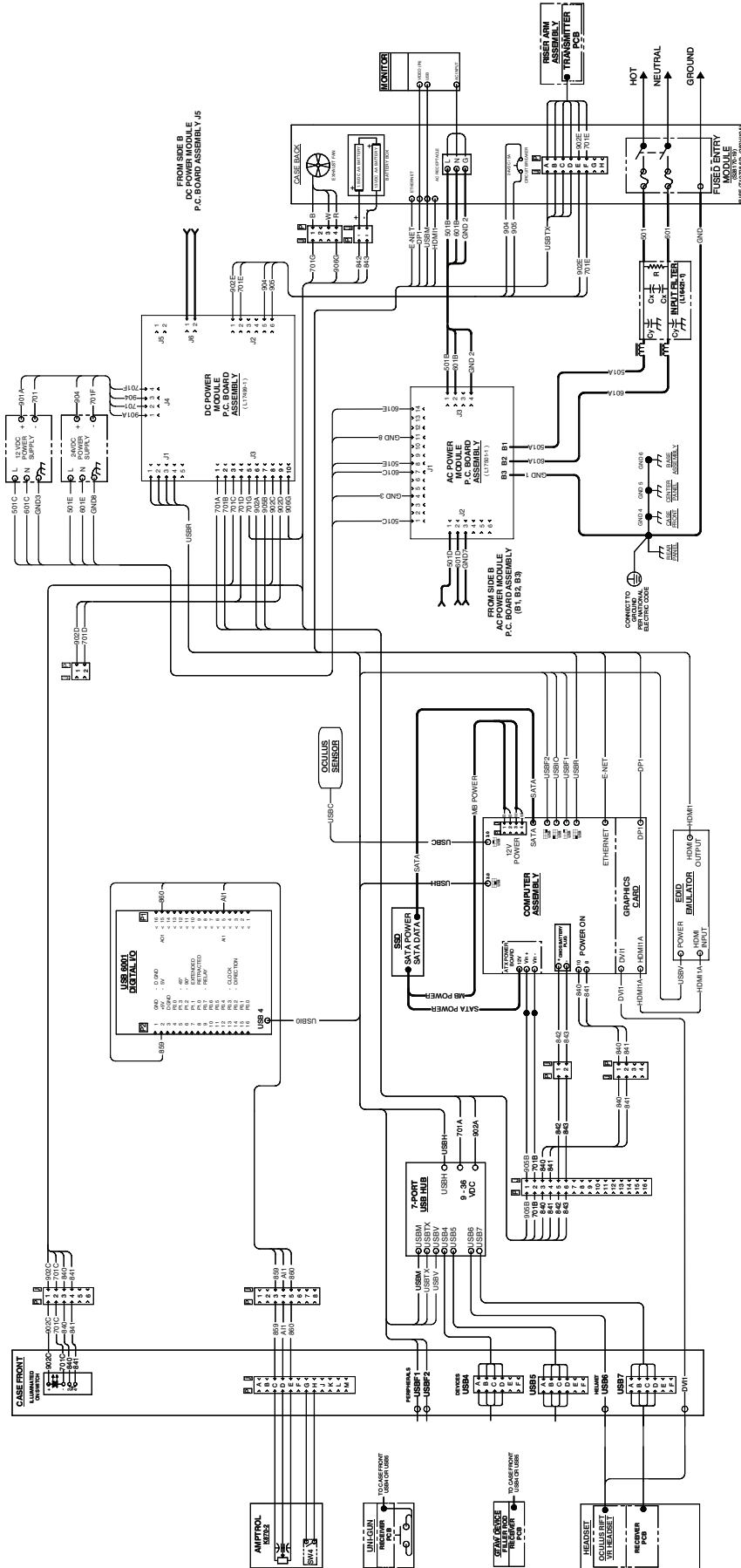

TRANSPORT +
SIDE A

NOTE: This diagram is for reference only. It may not be accurate for all machines covered by this manual. The specific diagram for a particular code is pasted inside the machine on one of the enclosure panels. If the diagram is illegible, contact the service department for a replacement. Give the equipment code number.

Figure 102 – Wiring diagram

K4633-1 VRTEX Transport+ - Wiring diagram

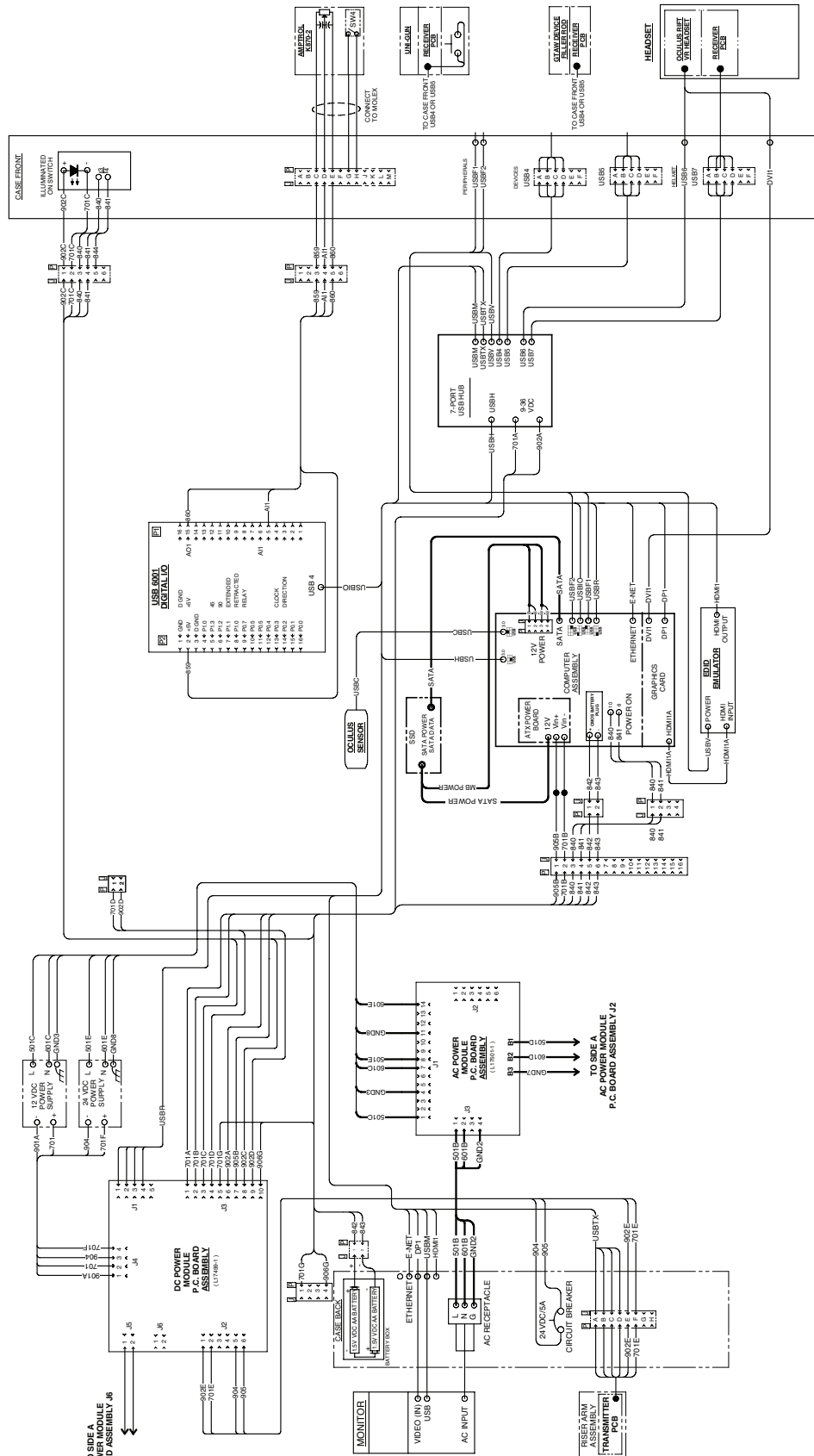

TRANSPORT + SIDE B

NOTE: This diagram is for reference only. It may not be accurate for all machines covered by this manual. The specific diagram for a particular code is pasted inside the machine on one of the enclosure panels. If the diagram is illegible, contact the service department for a replacement. Give the equipment code number.

CUSTOMER ASSISTANCE POLICY

The business of The Lincoln Electric Company is manufacturing and selling high quality welding equipment, consumables and cutting equipment. Our challenge is to meet the needs of our customers and to exceed their expectations. On occasion, purchasers may ask Lincoln Electric for advice or information about their use of our products. We respond to our customers based on the best information in our possession at that time. Lincoln Electric is not in a position to warrant or guarantee such advice and assumes no liability, with respect to such information or advice. We expressly disclaim any warranty of any kind, including any warranty of fitness for any customer's particular purpose, with respect to such information or advice. As a matter of practical consideration, we also cannot assume any responsibility for updating or correcting any such information or advice once it has been given, nor does the provision of information or advice create, expand or alter any warranty with respect to the sale of our products.

Lincoln Electric is a responsive manufacturer, but the selection and use of specific products sold by Lincoln Electric is solely within the control of and remains the sole responsibility of the customer. Many variables beyond the control of Lincoln Electric affect the results obtained in applying these types of fabrication methods and service requirements.

Subject to Change – This information is accurate to the best of our knowledge at the time of printing. Please refer to www.lincolnelectric.com for any updated information.



THE LINCOLN ELECTRIC COMPANY

22801 St. Clair Avenue • Cleveland, OH • 44117-1199 • U.S.A.

Phone: +1.888.935.3878 • www.lincolnelectric.com