

Operator's Manual

POWER MIG[®] 211i

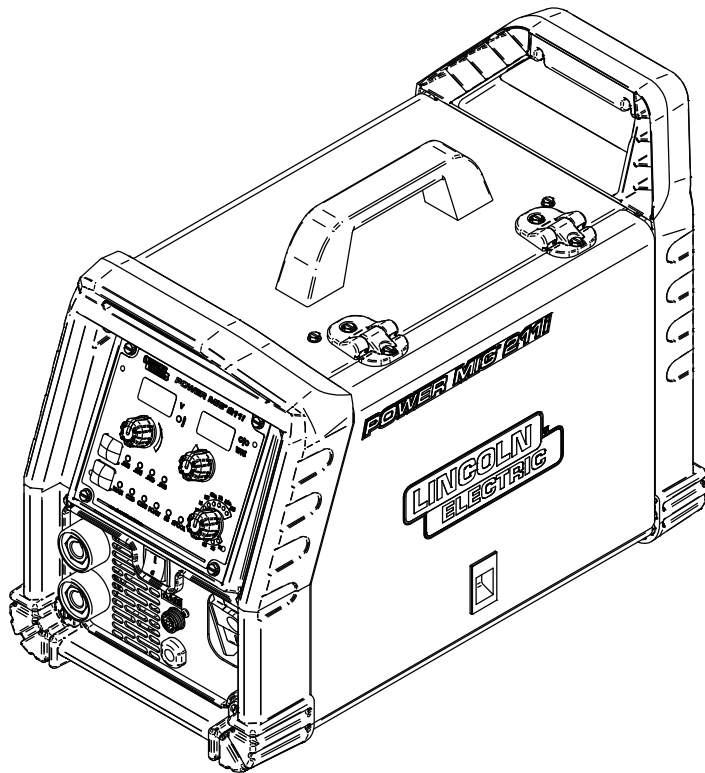

For use with machines having Code Numbers:

13214



Register your machine:

www.lincolnelectric.com/register

Authorized Service and Distributor Locator:

www.lincolnelectric.com/locator

Save for future reference

Date Purchased

Code: (ex: 10859)

Serial: (ex: U1060512345)

THANK YOU FOR SELECTING A QUALITY PRODUCT BY LINCOLN ELECTRIC.

PLEASE EXAMINE CARTON AND EQUIPMENT FOR DAMAGE IMMEDIATELY

When this equipment is shipped, title passes to the purchaser upon receipt by the carrier. Consequently, claims for material damaged in shipment must be made by the purchaser against the transportation company at the time the shipment is received.

SAFETY DEPENDS ON YOU

Lincoln arc welding and cutting equipment is designed and built with safety in mind. However, your overall safety can be increased by proper installation ... and thoughtful operation on your part. **DO NOT INSTALL, OPERATE OR REPAIR THIS EQUIPMENT WITHOUT READING THIS MANUAL AND THE SAFETY PRECAUTIONS CONTAINED THROUGHOUT.** And, most importantly, think before you act and be careful.

WARNING

This statement appears where the information must be followed exactly to avoid serious personal injury or loss of life.

CAUTION

This statement appears where the information must be followed to avoid minor personal injury or damage to this equipment.



KEEP YOUR HEAD OUT OF THE FUMES.

DON'T get too close to the arc. Use corrective lenses if necessary to stay a reasonable distance away from the arc.

READ and obey the Safety Data Sheet (SDS) and the warning label that appears on all containers of welding materials.

USE ENOUGH VENTILATION or exhaust at the arc, or both, to keep the fumes and gases from your breathing zone and the general area.

IN A LARGE ROOM OR OUTDOORS, natural ventilation may be adequate if you keep your head out of the fumes (See below).

USE NATURAL DRAFTS or fans to keep the fumes away from your face.

If you develop unusual symptoms, see your supervisor. Perhaps the welding atmosphere and ventilation system should be checked.

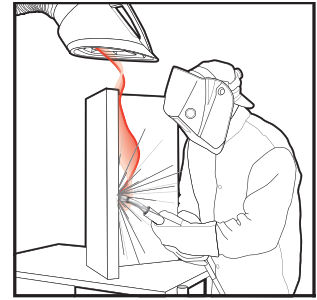

WEAR CORRECT EYE, EAR & BODY PROTECTION

PROTECT your eyes and face with welding helmet properly fitted and with proper grade of filter plate (See ANSI Z49.1).

PROTECT your body from welding spatter and arc flash with protective clothing including woolen clothing, flame-proof apron and gloves, leather leggings, and high boots.

PROTECT others from splatter, flash, and glare with protective screens or barriers.

IN SOME AREAS, protection from noise may be appropriate.

BE SURE protective equipment is in good condition.

Also, wear safety glasses in work area **AT ALL TIMES.**



SPECIAL SITUATIONS

DO NOT WELD OR CUT containers or materials which previously had been in contact with hazardous substances unless they are properly cleaned. This is extremely dangerous.

DO NOT WELD OR CUT painted or plated parts unless special precautions with ventilation have been taken. They can release highly toxic fumes or gases.

Additional precautionary measures

PROTECT compressed gas cylinders from excessive heat, mechanical shocks, and arcs; fasten cylinders so they cannot fall.

BE SURE cylinders are never grounded or part of an electrical circuit.

REMOVE all potential fire hazards from welding area.

ALWAYS HAVE FIRE FIGHTING EQUIPMENT READY FOR IMMEDIATE USE AND KNOW HOW TO USE IT.



SECTION A: WARNINGS



CALIFORNIA PROPOSITION 65 WARNINGS



WARNING: Breathing diesel engine exhaust exposes you to chemicals known to the State of California to cause cancer and birth defects, or other reproductive harm.

- Always start and operate the engine in a well-ventilated area.
- If in an exposed area, vent the exhaust to the outside.
- Do not modify or tamper with the exhaust system.
- Do not idle the engine except as necessary.

For more information go to www.P65warnings.ca.gov/diesel

WARNING: This product, when used for welding or cutting, produces fumes or gases which contain chemicals known to the State of California to cause birth defects and, in some cases, cancer. (California Health & Safety Code § 25249.5 *et seq.*)



WARNING: Cancer and Reproductive Harm
www.P65warnings.ca.gov

ARC WELDING CAN BE HAZARDOUS. PROTECT YOURSELF AND OTHERS FROM POSSIBLE SERIOUS INJURY OR DEATH. KEEP CHILDREN AWAY. PACEMAKER WEARERS SHOULD CONSULT WITH THEIR DOCTOR BEFORE OPERATING.

Read and understand the following safety highlights. For additional safety information, it is strongly recommended that you purchase a copy of "Safety in Welding & Cutting - ANSI Standard Z49.1" from the American Welding Society, P.O. Box 351040, Miami, Florida 33135 or CSA Standard W117.2. A Free copy of "Arc Welding Safety" booklet E205 is available from the Lincoln Electric Company, 22801 St. Clair Avenue, Cleveland, Ohio 44117-1199.

BE SURE THAT ALL INSTALLATION, OPERATION, MAINTENANCE AND REPAIR PROCEDURES ARE PERFORMED ONLY BY QUALIFIED INDIVIDUALS.



FOR ENGINE POWERED EQUIPMENT.

- Turn the engine off before troubleshooting and maintenance work unless the maintenance work requires it to be running.
- Operate engines in open, well-ventilated areas or vent the engine exhaust fumes outdoors.
- Do not add the fuel near an open flame welding arc or when the engine is running. Stop the engine and allow it to cool before refueling to prevent spilled fuel from vaporizing on contact



with hot engine parts and igniting. Do not spill fuel when filling tank. If fuel is spilled, wipe it up and do not start engine until fumes have been eliminated.

- Keep all equipment safety guards, covers and devices in position and in good repair. Keep hands, hair, clothing and tools away from V-belts, gears, fans and all other moving parts when starting, operating or repairing equipment.
- In some cases it may be necessary to remove safety guards to perform required maintenance. Remove guards only when necessary and replace them when the maintenance requiring their removal is complete. Always use the greatest care when working near moving parts.
- Do not put your hands near the engine fan. Do not attempt to override the governor or idler by pushing on the throttle control rods while the engine is running.
- To prevent accidentally starting gasoline engines while turning the engine or welding generator during maintenance work, disconnect the spark plug wires, distributor cap or magneto wire as appropriate.
- To avoid scalding, do not remove the radiator pressure cap when the engine is hot.
- Using a generator indoors CAN KILL YOU IN MINUTES.
- Generator exhaust contains carbon monoxide. This is a poison you cannot see or smell.
- NEVER use inside a home or garage, EVEN IF doors and windows are open.
- Only use OUTSIDE and far away from windows, doors and vents.
- Avoid other generator hazards. READ MANUAL BEFORE USE.



ELECTRIC AND MAGNETIC FIELDS MAY BE DANGEROUS



- Electric current flowing through any conductor causes localized Electric and Magnetic Fields (EMF). Welding current creates EMF fields around welding cables and welding machines
- EMF fields may interfere with some pacemakers, and welders having a pacemaker should consult their physician before welding.
- Exposure to EMF fields in welding may have other health effects which are now not known.
- All welders should use the following procedures in order to minimize exposure to EMF fields from the welding circuit:
 - Route the electrode and work cables together - Secure them with tape when possible.
 - Never coil the electrode lead around your body.
 - Do not place your body between the electrode and work cables. If the electrode cable is on your right side, the work cable should also be on your right side.
 - Connect the work cable to the workpiece as close as possible to the area being welded.
 - Do not work next to welding power source.



ELECTRIC SHOCK CAN KILL.



- 3.a. The electrode and work (or ground) circuits are electrically “hot” when the welder is on. Do not touch these “hot” parts with your bare skin or wet clothing. Wear dry, hole-free gloves to insulate hands.
- 3.b. Insulate yourself from work and ground using dry insulation. Make certain the insulation is large enough to cover your full area of physical contact with work and ground.

In addition to the normal safety precautions, if welding must be performed under electrically hazardous conditions (in damp locations or while wearing wet clothing; on metal structures such as floors, gratings or scaffolds; when in cramped positions such as sitting, kneeling or lying, if there is a high risk of unavoidable or accidental contact with the workpiece or ground) use the following equipment:

- Semiautomatic DC Constant Voltage (Wire) Welder.
 - DC Manual (Stick) Welder.
 - AC Welder with Reduced Voltage Control.
- 3.c. In semiautomatic or automatic wire welding, the electrode, electrode reel, welding head, nozzle or semiautomatic welding gun are also electrically “hot”.
 - 3.d. Always be sure the work cable makes a good electrical connection with the metal being welded. The connection should be as close as possible to the area being welded.
 - 3.e. Ground the work or metal to be welded to a good electrical (earth) ground.
 - 3.f. Maintain the electrode holder, work clamp, welding cable and welding machine in good, safe operating condition. Replace damaged insulation.
 - 3.g. Never dip the electrode in water for cooling.
 - 3.h. Never simultaneously touch electrically “hot” parts of electrode holders connected to two welders because voltage between the two can be the total of the open circuit voltage of both welders.
 - 3.i. When working above floor level, use a safety belt to protect yourself from a fall should you get a shock.
 - 3.j. Also see Items 6.c. and 8.



ARC RAYS CAN BURN.



- 4.a. Use a shield with the proper filter and cover plates to protect your eyes from sparks and the rays of the arc when welding or observing open arc welding. Headshield and filter lens should conform to ANSI Z87.1 standards.
- 4.b. Use suitable clothing made from durable flame-resistant material to protect your skin and that of your helpers from the arc rays.
- 4.c. Protect other nearby personnel with suitable, non-flammable screening and/or warn them not to watch the arc nor expose themselves to the arc rays or to hot spatter or metal.



FUMES AND GASES CAN BE DANGEROUS.



- 5.a. Welding may produce fumes and gases hazardous to health. Avoid breathing these fumes and gases. When welding, keep your head out of the fume. Use enough ventilation and/or exhaust at the arc to keep fumes and gases away from the breathing zone. **When welding hardfacing (see instructions on container or SDS) or on lead or cadmium plated steel and other metals or coatings which produce highly toxic fumes, keep exposure as low as possible and within applicable OSHA PEL and ACGIH TLV limits using local exhaust or mechanical ventilation unless exposure assessments indicate otherwise. In confined spaces or in some circumstances, outdoors, a respirator may also be required. Additional precautions are also required when welding on galvanized steel.**
- 5.b. The operation of welding fume control equipment is affected by various factors including proper use and positioning of the equipment, maintenance of the equipment and the specific welding procedure and application involved. Worker exposure level should be checked upon installation and periodically thereafter to be certain it is within applicable OSHA PEL and ACGIH TLV limits.
- 5.c. Do not weld in locations near chlorinated hydrocarbon vapors coming from degreasing, cleaning or spraying operations. The heat and rays of the arc can react with solvent vapors to form phosgene, a highly toxic gas, and other irritating products.
- 5.d. Shielding gases used for arc welding can displace air and cause injury or death. Always use enough ventilation, especially in confined areas, to insure breathing air is safe.
- 5.e. Read and understand the manufacturer’s instructions for this equipment and the consumables to be used, including the Safety Data Sheet (SDS) and follow your employer’s safety practices. SDS forms are available from your welding distributor or from the manufacturer.
- 5.f. Also see item 1.b.



WELDING AND CUTTING SPARKS CAN CAUSE FIRE OR EXPLOSION.



- 6.a. Remove fire hazards from the welding area. If this is not possible, cover them to prevent the welding sparks from starting a fire. Remember that welding sparks and hot materials from welding can easily go through small cracks and openings to adjacent areas. Avoid welding near hydraulic lines. Have a fire extinguisher readily available.
- 6.b. Where compressed gases are to be used at the job site, special precautions should be used to prevent hazardous situations. Refer to "Safety in Welding and Cutting" (ANSI Standard Z49.1) and the operating information for the equipment being used.
- 6.c. When not welding, make certain no part of the electrode circuit is touching the work or ground. Accidental contact can cause overheating and create a fire hazard.
- 6.d. Do not heat, cut or weld tanks, drums or containers until the proper steps have been taken to insure that such procedures will not cause flammable or toxic vapors from substances inside. They can cause an explosion even though they have been "cleaned". For information, purchase "Recommended Safe Practices for the Preparation for Welding and Cutting of Containers and Piping That Have Held Hazardous Substances", AWS F4.1 from the American Welding Society (see address above).
- 6.e. Vent hollow castings or containers before heating, cutting or welding. They may explode.
- 6.f. Sparks and spatter are thrown from the welding arc. Wear oil free protective garments such as leather gloves, heavy shirt, cuffless trousers, high shoes and a cap over your hair. Wear ear plugs when welding out of position or in confined places. Always wear safety glasses with side shields when in a welding area.
- 6.g. Connect the work cable to the work as close to the welding area as practical. Work cables connected to the building framework or other locations away from the welding area increase the possibility of the welding current passing through lifting chains, crane cables or other alternate circuits. This can create fire hazards or overheat lifting chains or cables until they fail.
- 6.h. Also see item 1.c.
- 6.i. Read and follow NFPA 51B "Standard for Fire Prevention During Welding, Cutting and Other Hot Work", available from NFPA, 1 Batterymarch Park, PO box 9101, Quincy, MA 022690-9101.
- 6.j. Do not use a welding power source for pipe thawing.



CYLINDER MAY EXPLODE IF DAMAGED.

- 7.a. Use only compressed gas cylinders containing the correct shielding gas for the process used and properly operating regulators designed for the gas and pressure used. All hoses, fittings, etc. should be suitable for the application and maintained in good condition. 
- 7.b. Always keep cylinders in an upright position securely chained to an undercarriage or fixed support.
- 7.c. Cylinders should be located:
 - Away from areas where they may be struck or subjected to physical damage.
 - A safe distance from arc welding or cutting operations and any other source of heat, sparks, or flame.
- 7.d. Never allow the electrode, electrode holder or any other electrically "hot" parts to touch a cylinder.
- 7.e. Keep your head and face away from the cylinder valve outlet when opening the cylinder valve.
- 7.f. Valve protection caps should always be in place and hand tight except when the cylinder is in use or connected for use.
- 7.g. Read and follow the instructions on compressed gas cylinders, associated equipment, and CGA publication P-1, "Precautions for Safe Handling of Compressed Gases in Cylinders," available from the Compressed Gas Association, 14501 George Carter Way Chantilly, VA 20151.



FOR ELECTRICALLY POWERED EQUIPMENT.



- 8.a. Turn off input power using the disconnect switch at the fuse box before working on the equipment.
- 8.b. Install equipment in accordance with the U.S. National Electrical Code, all local codes and the manufacturer's recommendations.
- 8.c. Ground the equipment in accordance with the U.S. National Electrical Code and the manufacturer's recommendations.

Refer to
<http://www.lincolnelectric.com/safety>
for additional safety information.

	Page
Product Description	7
Changes After Initial Release	7
Product Description	7
Product Summary	7
Recommended Processes and Equipment	8
Recommended Processes	8
Process Limitations	8
Equipment Limitations	8
Select Suitable Location	8
Common Equipment Packages	8
Design	9
Specifications	9
Regulatory Requirements	10
Design Features	10
Case Front Controls	11
Case Front Control Descriptions	11
Case Back	12
Case Rear Components Description	12
Internal Controls	12
Internal Controls Description	12
Installation	14
Safety Information	14
Input and Ground Connections	14
Location and Mounting	14
High Frequency Protection	14
Connection Diagram(s), System	15
Electrode and Work Connections	16
Operation	17
Graphic Symbols	17
Power-Up Sequence	17
Duty Cycle	18
General Options and Accessories	19
Drive Roll Kits	19
Maintenance	20
Routine Maintenance	20
General Maintenance	20
Periodic Maintenance	20
Troubleshooting	21
How to Use Troubleshooting Guide	21
Capacitor Discharge Procedure	21
Troubleshooting Guide	22
Diagrams	24
Wiring Diagram	24
Dimension Print	25
Parts List	parts.lincolnelectric.com

Content/details may be changed or updated without notice. For most current Instruction Manuals, go to parts.lincolnelectric.com.

PRODUCT DESCRIPTION

PRODUCT SUMMARY

The Power MIG® 211i is a constant voltage DC welding machine rated for 175 amps, 22.8 volts at a 30% duty cycle. The Power MIG® units are intended for fabrication, maintenance, home, and autobody shops. The unit features a portable and rugged case. The user interface features two displays, one for voltage and one for wire feed speed. The machine also features a cast aluminum based wire drive system and an integrated switch for activating a Magnum Pro 100SG spool gun. The Power MIG® 211i is designed for the North American market and operates on 120 or 230 single phase 60 Hz power. An overview of the machines input and output capabilities are listed on the rating plate shown at right.

- The Power MIG® 211i is Magnum Pro 100SG spool gun ready; the spool gun switch is preinstalled from the factory and an option is present on the user interface which permits activating the spool gun wire drive. Both items must be selected to activate the spool gun.
- The machine comes with the following accessories:
 - Magnum Pro 100L gun
 - Work cable with clamp
 - Spare contact tips
 - Gas regulator and gas hose
 - Gas nozzle
 - 120V to 230V Input Adapter
 - Sample spool of MIG wire
 - Spindle adapter
 - Quick setup guide and literature

POWER MIG® 211i

Assembled in Mexico
THE LINCOLN ELECTRIC CO.
CLEVELAND, OHIO U.S.A.

IEC 60974-1
IEC 60974-5

20 A/15 V to 211 A/24.6 V						
		U₁ = 120 V		U₁ = 230 V		
		X	60%	100%	30%	100%
	U₀	I₂	95 A	75 A	175 A	90 A
	76 V	U₂	18.8 V	17.8 V	22.8 V	18.6 V

		U₁	I_{1 max}	I_{1 eff}
		120 V	20 A	15 A
		230 V	22.5 A	15 A

IP21S

Patent(s): www.lincolnelectric.com/patents

PARTS AND LABOR
PARTES Y MANO DE OBRA
PIÈCES ET MAIN D'OEUVRE

3

YEAR WARRANTY
AÑOS DE GARANTIA
ANS DE GARANTIE

LINCOLN®
ELECTRIC

S35550 VM

RECOMMENDED PROCESSES AND EQUIPMENT

RECOMMENDED PROCESSES

The Power MIG® 211i is recommended for GMAW and FCAW processes. The machine can support 4 inch and 8 inch spools of wire for GMAW and FCAW welding. The machine is intended for the following wire diameters and composition; Innershield NR-211® .030 - .045 self-shielding electrode and NR-212® .045 self shielding electrode, .035 Outershield 71M FCAW-GS, SuperArc L-56 .025" through .035" solid steel, .030 & .035" stainless MIG wires, and SuperGlaze .030" through .035" aluminum.

PROCESS LIMITATIONS

Welding aluminum requires use of the Magnum® Pro 100SG Spool Gun.

EQUIPMENT LIMITATIONS

The Power MIG® 211i is capable of MIG welding at 175 amperes of current at 22.8 VDC, this output can be achieved at a 30% duty cycle based on a ten minute cycle time with the machine connected to 230VAC input. The machine is capable of higher duty cycles at lower output currents or higher amperages at lower duty cycles. The machine can be connected to either 230VAC @60Hz or 120VAC @ 60Hz. The output of the machine is limited when the machine is connected to 120VAC input, details regarding the rating when the machine is connected to 120VAC can be seen on the rating plate.

Locate the welder in a dry location with free circulation of clean air into the back. A location that minimizes the amount of smoke and dirt drawn into the rear louvers, will reduce the probability of dirt accumulating and blocking air passages which can cause overheating.

SELECT SUITABLE LOCATION

Place the machine on a secure, level surface or recommended undercarriage. The machine may topple over if this procedure is not followed. To minimize over heating, locate the welder in a dry location where there is free circulation of clean air. Do not place on combustible surfaces.

COMMON EQUIPMENT PACKAGES

BASIC PACKAGE: CODE 13214		DETAILS
K6080-1	<ul style="list-style-type: none"> • WIRE-FEEDER-WELDER • GROUND CABLE AND CLAMP • SAMPLE SPOOL OF WIRE • MAGNUM PRO 100L GUN • GAS REGULATOR AND HOSE • SPARE CONTACT TIP • DRIVE ROLL AND WIRE GUIDES • SPINDLE ADAPTER • GAS NOZZLE 	

OPTIONAL KITS		
TYPE	PRODUCT NUMBER	DETAILS
GENERAL	K520	UTILITY CART (150 CU FT. BOTTLE CAPACITY)
	K2528-1	INNERSHIELD WELDING KIT
SPOOL- GUN	K3269-1	MAGNUM PRO 100SG SPOOL GUN

TEMPERATURE RANGES	
OPERATING TEMPERATURE	-4°F TO 104°F (-20C TO 40C)
STORAGE TEMPERATURE	-40°F TO 185°F (-40C TO 85C)

DESIGN

SPECIFICATIONS

POWER SOURCES - INPUT VOLTAGE AND CURRENT			
DUTY CYCLE (OUTPUT)	INPUT VOLTAGE	INPUT AMPERES MAX	IDLE AMPS
30% (175A / 22.8V)	230	22.5A	.7A
60% (95A / 18.8V)	120	20A	.7A

WELDING PROCESSES			
PROCESS	ELECTRODE DIAMETER RANGE	OUTPUT RANGE (AMPERES)	WIRE FEED SPEED RANGE
GMAW	.025-.035" (0.6-1.0MM)	20-211	50-500 IPM
FCAW	.030-.045" (0.8-1.2MM)	20-211	50-500 IPM

POWER SOURCES - RECOMMENDED INPUT WIRE AND FUSE SIZES ¹			
VOLTAGE/ PHASE FREQUENCY	INPUT AMPERES EFFECTIVE	FUSE (SUPER LAG) OR BREAKER SIZE ²	TYPE 75C COPPER WIRE IN CONDUIT AWG (IEC) SIZES 40C (104°F) AMBIENT
230/1/60	15A	40	12
120/1/60	15A	20	12

² Also called 'inverse time' or 'thermal/magnetic' circuit breakers; circuit breakers that have a delay in tripping action that decreases as the magnitude of current increases.

PHYSICAL DIMENSIONS				
MODEL	HEIGHT	WIDTH	DEPTH	WEIGHT
K6080-1	15.10IN (383MM)	10.90IN (276MM)	21.49IN (546MM)	41 LBS 18.6 KG

ENGINE DRIVEN GENERATOR

The machine is designed to operate on engine driven generators as long as the auxiliary can supply adequate voltage, frequency and power as indicated in the "Technical Specification" Installation Section of this manual. The auxiliary supply of the generator must also meet the following conditions:

Frequency: 60 Hz

RMS voltage of the AC waveform: 90-250 V; Out of this range will trigger undervoltage and overvoltage protections.

Generator Minimum 3 kW (120VAC) 6kW (230VAC)

It is important to check these conditions because many engine driven generators produce high voltage spikes. Operation of this machine with engine driven generators not conforming to these conditions is not recommend and may damage the machine and is also NOT covered by warranty.

¹ Cord and Fuse Sizes based upon the U.S. National Electric Code and maximum output

REGULATORY REQUIREMENTS

MODEL	MARKET	CONFORMITY MARK	STANDARD
K6080-1	US AND CANADA	cCSAus	IEC 60974-1 IEC 60974-5

IP RATING	INTENDED USE
IP21S	For Internal Use Only

DESIGN FEATURES

- **Efficient Inverter power topology**- reduces power consumption and reduces the mass of the unit when compared with traditional SCR based machines.
- **High Power Factor**- The Power MIG® 211i features active power factor correction (>.98) which reduces the unit's current draw.
- **120 or 230V Capable**- Easily connect the unit to 120V or for higher loads connect to 230V. The unit includes a hardwired 230V cord and a 120V to 230V input adapter for easily switching between the two input voltages.
- **Portability**: The unit features three handles for carrying in multiple orientations; single hand or two hand carry.
- **Full line of Accessories**: Each unit will include a Magnum® Pro Gun for MIG welding, work clamp and cable, sample spool and tip, spindle adapter for loading 8 inch spools, gas regulator and gas hose.
- **Compact, Durable Case** –IP21S enclosure rating ensures the Power MIG® 211i will withstand the intended welding environments.
- **Integrated Cast-Aluminum Wire Drive** - for reliable feeding of MIG and FCAW wires
- **Integrated Gas Solenoid** – Dedicated gas solenoid for wire processes.
- **3 Year Warranty on Parts and Labor.**
- **25-amp resettable protector**

CASE FRONT CONTROLS

FIGURE A.1

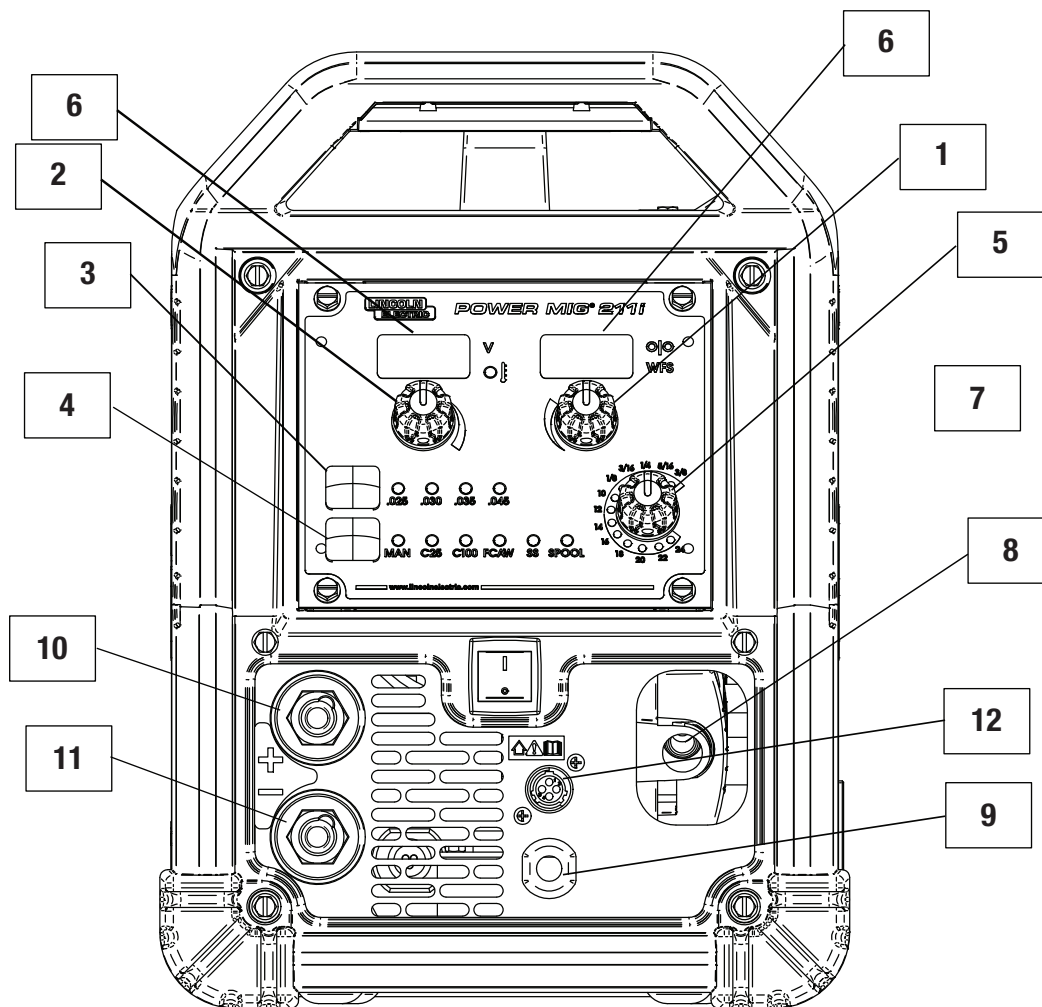

CASE FRONT CONTROL DESCRIPTIONS

1. **Adjustment Knob** – Permits selecting wire feed speed for MIG & FCAW welding.
2. **Adjustment Knob** – Permits selecting voltage for MIG & FCAW welding.
3. **Wire Diameter Select Button** – Permits selecting the appropriate wire diameter.
4. **Process Select Button** – Permits selecting the desired process or manual mode for selecting voltage + WFS as needed.
5. **Material Thickness Selector**
6. **Seven Segment Displays** – For displaying setpoint voltage and wirefeed speed.
7. **Power Switch** - Permits turning the machine on or off.
8. **Gun Connection** - Permits attachment of a MIG welding gun. Ensure the gun is fully seated into the brass receptacle.
9. **Wire Drive Polarity Lead** - Permits configuring the wire drive to positive or negative polarity by inserting into the positive or negative stud. Ensure connector is tightly locked into place by rotating clockwise.
10. **Positive Output Receptacle** - Permits attaching a work lead, electrode stinger or the center wire drive polarity lead to DC positive polarity. Rotate clockwise to lock into place.
11. **Negative Output Receptacle** - Permits attaching a work lead, electrode stinger, or the center wire drive polarity lead to DC negative polarity. Rotate connector clockwise to lock into place.
12. **Four Pin Trigger Receptacle** - Permits triggering the machine for MIG/FCAW or aluminum MIG. Connect the 4-pin connector present on the welding gun to the receptacle.

CASE BACK

FIGURE A.2

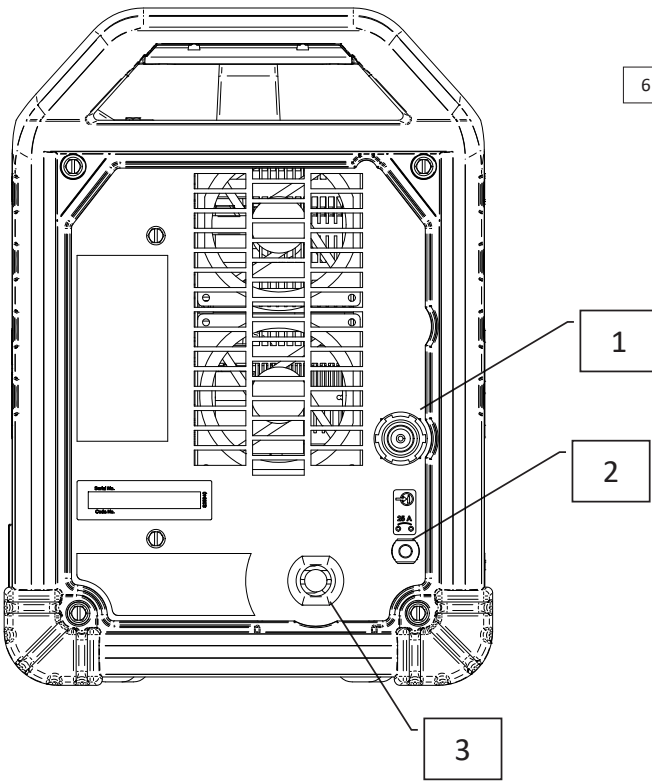

CASE REAR COMPONENTS DESCRIPTION

1. **MIG Gas Solenoid Connector** - Connection for the gas hose of the MIG shielding gas.
2. **Thermal Breaker** - The Power MIG® 215 MPi™ features a resettable 25 amp thermal breaker. If the current conducted through the breaker exceeds 25 amps for an extended period of time, the breaker will open and require manual reset.
3. **230V Input Cord** – Hardwired 230V input cord. 120V to 230V input adapter included for easy 120V compatibility.

INTERNAL CONTROLS

FIGURE A.3

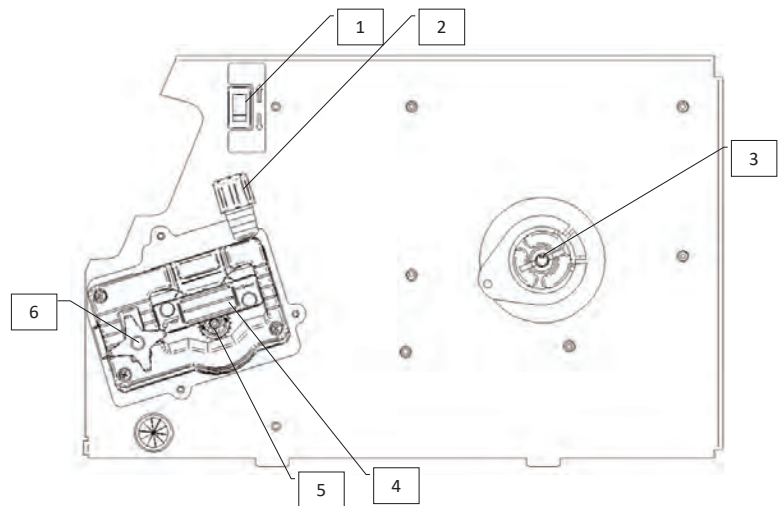

INTERNAL CONTROLS DESCRIPTION

1. **Spool Gun Switch** – Permits toggling between standard push gun welding with the Magnum® Pro 100L or aluminum welding with the Magnum® Pro 100SG Spool Gun.
2. **Wire Drive Tension Pressure Adjustment** – Permits increasing or decreasing the pressure applied to the top drive roll.
3. **Wire Drive Spindle** – Supports a 4-inch or 8-inch spool of wire. The center wing-nut can be adjusted to increase tension on the wire.
4. **Replaceable Wire Guide** – Select the correct inner wire guide for the desired wire diameter. The outer wire guide provided can be used for any wire diameter.
5. **Replaceable drive roll** – Select the correct drive roll for the wire diameter and composition being fed.
6. **Gun Connector Block** – Permits securing a welding gun to the wire drive by ensuring the gun connector is fully seated, then tightening the large knob

INSTALLATION



WARNING



ELECTRIC SHOCK can kill.

- Do not touch electrically live parts or electrode with skin or wet clothing. Insulate yourself from work and ground.
- Always wear dry insulating gloves.



FUMES AND GASES can be dangerous.

- Keep your head out of fumes.
- Use ventilation or exhaust to remove fumes from breathing zone.

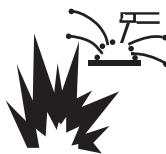

WELDING SPARKS can cause fire or explosion.

- Keep flammable material away.
- Do not weld on closed containers.



ARC RAYS can burn eyes and skin.

- Wear eye, ear and body protection.

Observe all safety information throughout this manual.

INPUT AND GROUND CONNECTIONS

1. Before starting the installation, check with the local power company if there are any questions about whether your power supply is adequate for the voltage, amperes, phase, and frequency specified on the welder rating plate. Also be sure the planned installation will meet the U.S. National Electrical Code and local code requirements. This welder may be operated from a single phase line or from one phase of a two or three phase line.
2. The power cord adapter supplied with the unit shall only be used with the Power MIG® 211i unit.
3. The Power MIG® 211i is shipped with a hardwired 230V cord and a 120V to 230V input adapter.
4. Using the instructions in Figure B.2, have a qualified electrician connect a receptacle (Customer Supplied) or cable to the input power lines and the system ground per the U.S. National Electrical Code and any applicable local codes. For cords over 100 foot, larger copper wires should be used. Fuse the two hot lines with super lag type fuses as shown in the following diagram. The center contact in the receptacle is for the grounding connection. A green wire in the input cable connects this contact to the frame of the welder. This ensures proper grounding of the welder frame when the welder plug is inserted into a grounded receptacle.

FIGURE B.2

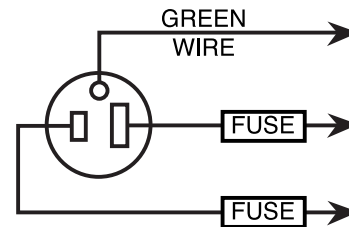

CONNECT TO A SYSTEM GROUNDING WIRE. SEE THE UNITED STATES NATIONAL ELECTRICAL CODE AND/OR LOCAL CODES FOR OTHER DETAILS AND MEANS FOR PROPER GROUNDING. CONNECT TO HOT WIRES OF A THREE-WIRE, SINGLE PHASE SYSTEM.

LOCATION AND MOUNTING

The Power MIG® 211i will operate in harsh environments. Even so, it is important that preventative measures are followed in order to assure long life, reliability, and safe operation.

- The Power MIG® 211i must be located in an area with circulation of clean air such that air movement in the back and out the front louvers.
- Dirt and dust that can be drawn into the Power MIG® 211i should be kept to a minimum. Failure to observe these precautions can result in excessive operating temperatures and nuisance thermal trips.

PROPER HANDLING

The Power MIG 211i should be lifted by the center handle or by grasping both the front and back handles simultaneously. The machine should never be lifted by the input cord, output cables, welding gun, or trigger connection. Use appropriate lifting methods to reduce the chance of back injury during manual handling.

HIGH FREQUENCY PROTECTION

During operation, distance the Power MIG® 211i from radio controlled machinery. The normal operation of the Power MIG® 211i may adversely affect the operation of RF controlled equipment, which may result in bodily injury or damage to the equipment.

CONNECTION DIAGRAM(S), SYSTEM

GUN AND CABLE INSTALLATION

The Magnum® PRO 100L gun and cable provided with the Power MIG® 211i is factory installed with a liner for .025-.035" (0.9-1.2 mm) wire and an .035" (0.9mm) contact tip. The user should ensure that the contact tip, liner, and drive rolls match the size of the wire being used.



WARNING

Turn the welder power switch "off" before installing gun and cable.

1. Lay the cable straight.
2. Unscrew the bolt which is threaded into the brass connecting block (inside wire feed compartment).
3. Insert the male end of gun into the female casting through opening in front panel. Ensure the connector is fully inserted, and then tighten the knurled screw.
4. Connect the gun trigger connector from the gun and cable to the mating receptacle located on the machine case front. Make sure that the keyways are aligned, insert and tighten the retaining ring.

SHIELDING GAS

(For Gas Metal Arc Welding Processes)

Customer must provide cylinder of appropriate type shielding gas for the process being used.

A gas flow regulator, for Argon blend gas, and an inlet gas hose are factory provided with the Power MIG® 211i. When using 100% CO₂ an additional adapter will be required to connect the regulator to the gas bottle.



WARNING



CYLINDER may explode if damaged.
Gas under pressure is explosive. Always keep gas cylinders in an upright position and always keep chained to undercarriage or stationary support. See American National Standard Z-49.1. "Safety in Welding and Cutting" published by the American Welding Society.

Install shielding gas supply as follows:

1. Set the gas cylinder on a flat surface and secure the cylinder to a sturdy structure to prevent the cylinder from falling over.



WARNING

2. Remove the cylinder cap. Inspect the cylinder valves and regulator for damaged threads, dirt, dust, oil or grease. Remove dust and dirt with a clean cloth.

DO NOT ATTACH THE REGULATOR IF OIL, GREASE OR DAMAGE IS PRESENT! Inform your gas supplier of this condition. Oil or grease in the presence of high pressure oxygen is explosive.

3. Stand to one side away from the outlet and open the cylinder valve for an instant. This will eradicate any dust or dirt which may have accumulated in the valve outlet.



WARNING

The user should distance his or her body from the valve outlet when "cracking" the valve.

4. Attach the flow regulator to the cylinder valve and tighten the union nut(s) securely with a wrench.

NOTE: If connecting to 100% CO₂ cylinder, an additional regulator adapter must be installed between the regulator and cylinder valve. If adapter is equipped with a plastic washer, be sure it is seated for connection to the CO₂ cylinder.

5. Attach one end of the inlet gas hose to the outlet fitting of the flow regulator, the other end to the Power MIG® 211i rear fitting, and tighten the union nuts with a wrench. Maximum gas pressure leaving the regulator and entering the machine to not exceed 5 bar (0.5MPa) or 72 psi.
6. Before opening the cylinder valve, turn the regulator adjusting knob counterclockwise until the adjusting spring pressure is released.
7. While standing to one side, open the cylinder valve slowly a fraction of a turn. When the cylinder pressure gauge pointer stops moving, open the valve fully.



WARNING

Never stand directly in front of or behind the flow regulator when opening the cylinder valve. Always stand to one side.

8. The flow regulator is adjustable. Adjust the regulator to the flow rate recommended for the procedure and process being used.

ELECTRODE AND WORK CONNECTIONS

OUTPUT POLARITY CONNECTIONS

The Power MIG® 211i features a short lead protruding from the front of the machine, the lead can be used to configure the wire drive polarity. For FCAW and GMAW welding this lead can be connected to either the positive output stud or negative output stud. Connecting the lead to the positive stud will electrically connect the wire drive to positive polarity; the work clamp would then connect to the negative stud. Ensure connector is tightly locked into place by rotating clockwise.

PROCEDURE FOR CHANGING DRIVE AND IDLE ROLL SETS















1. Turn off the power source.
2. Release the pressure on the idle roll by swinging the adjustable pressure arm down toward the back of the machine. Lift the cast idle roll assembly and allow it to sit in an upright position.
3. Remove the outside wire guide retaining plate by loosening the two large knurled screws.
4. Twist the drive roll retaining mechanism to the unlocked position as shown below and remove the drive roll.
5. Remove the inside wire guide plate.
6. Replace the drive roll and inside wire guide with a set marked for the new wire size.

NOTE: Be sure that the gun liner and contact tip are also sized to match the selected wire size.

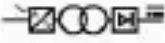
7. Manually feed the wire from the wire reel, over the drive roll groove and through the wire guide and then into the brass bushing of the gun and cable assembly.
8. Replace the outside wire guide retaining plate by tightening the two large knurled screws. Reposition the adjustable pressure arm to its original position to apply pressure. Adjust pressure as necessary.

OPERATION

GRAPHIC SYMBOLS USED IN THIS MANUAL OR BY THIS MACHINE

	INPUT POWER		
	ON	U_0	OPEN CIRCUIT VOLTAGE
	OFF	U_1	INPUT VOLTAGE
	HIGH TEMPERATURE	U_2	OUTPUT VOLTAGE
	CIRCUIT BREAKER	I_1	INPUT CURRENT
	WIRE FEEDER	I_2	OUTPUT CURRENT
	POSITIVE OUTPUT		PROTECTIVE GROUND
	NEGATIVE OUTPUT		
	INVERTER		WARNING or CAUTION
	INPUT POWER		Explosion
	DIRECT CURRENT		Dangerous Voltage
			Shock Hazard

POWER-UP SEQUENCE

1. Check that the electrode polarity is correct for the process being used, then turn the power switch ON. The fan will come on and stay on until power to the machine is removed.
2. Configure the machine for the desired process and application. The user can select one of the desired processes and the diameter of the electrode they have chosen. After the diameter select, the user will have an opportunity to select the thickness of material they intend to weld. With these inputs the interface will determine the best settings for the selected input values.
3. Press the trigger to feed the wire electrode through the gun and cable and then cut the electrode within approximately 3/8" (10 mm) from the end of the contact tip.
4. If shielding gas is to be used, turn on the gas supply and set the required flow rate (typically 25-35 CFH; 12-16 liters/min).
5. When using an Innershield electrode, the gas nozzle may be removed and replaced with the gasless nozzle. This will provide increased visibility and eliminate the possibility of the gas nozzle overheating.
6. Connect the work cable to the metal to be welded. The work clamp must make a good electrical contact with the work. The work must also be grounded as stated in "Arc Welding Safety Precautions."

The duty cycle is the “on” time (based on a 10 minute interval) the user can weld with the machine at a specific output without causing a thermal trip.

Example: 30% duty cycle means welding at the specified output for 3 constant minutes and needing 7 minutes of “off” time before welding again.

INPUT LINE VOLTAGE VARIATIONS

High Line Voltage/ Low Line Voltage — The Power MIG® 211i will operate between 100 and 250 VAC 60Hz.

WIRE FEED OVERLOAD PROTECTION

The Power MIG® 211i features overload protection of the wire drive motor. If the motor becomes overloaded, the protection circuitry turns off the wire feed unit. Check for the proper size tip, liner, and drive rolls, for any obstructions or bends in the gun cable, and any other factors that would impede the wire feeding. To resume welding, simply pull the trigger. There is no circuit breaker to reset.

If the duty cycle of the machine is exceeded, then the machine will thermally trip and the Thermal LED will be illuminated on the user interface. The machine must cool down before welding can be performed.

SPOOL GUN OPERATION

When pulling the trigger on a spool gun, the spool gun drive rolls will ramp to a fixed wire feed speed until the machine senses a welding arc has been established. At which point, the spool gun drive rolls will adjust speed equal to the wire feed speed setpoint selected on the user interface.

GENERAL OPTIONS / ACCESSORIES

Description	Part Number
.025 Magnum Pro Tapered Contact Tip	KP2744-.025T
.030 Magnum Pro Tapered Contact Tip	KP2744-.030T
.035 Magnum Pro Tapered Contact Tip	KP2744-.035T
.045 Magnum Pro Tapered Contact Tip	KP2744-.045T
.025-.035 Gun Liner	KP35-40-15
.035 to .045 Gun Liner	KP45-40-15
Magnum Pro 100L Gun	K4528-1
Magnum Pro 100SG Spool Gun	K3269-1
Magnum Pro Gas Nozzle	KP3075-1-38F
Magnum Pro Flux Gasless Nozzle	KP3084-1
.025-.030 Drive Roll (MIG)	KP2529-1
.035 Drive Roll (MIG)	KP2529-2
.030-.045 Drive Roll (Flux-Cored)	KP2529-3
Welding Cart	K520

ROUTINE MAINTENANCE



WARNING



Before carrying out service, maintenance and/or repair jobs, fully disconnect power to the machine.



Use Personal Protective Equipment (PPE), including safety glasses, dust mask and gloves to avoid injury. This also applies to persons who enter the work area.



MOVING PARTS can injure.

- Do not operate with doors open or guards off.
- Stop engine before servicing.
- Keep away from moving parts.



Have qualified personnel do all maintenance and troubleshooting work.

GENERAL MAINTENANCE

In extremely dusty locations, dirt may clog the air passages causing the welder to run hot. Blow dirt out of the welder with low-pressure air at regular intervals to eliminate excessive dirt and dust build-up on internal parts.

The fan motor has a sealed bearing, which requires no service.

DRIVE ROLLS AND GUIDE PLATES

After every coil of wire, inspect the wire drive mechanism. Clean it as necessary by blowing with low pressure compressed air. Do not use solvents for cleaning the idle roll because it may wash the lubricant out of the bearing. All drive rolls are stamped with the wire sizes they will feed. If a wire size other than that stamped on the roll is used, the drive roll must be changed.

GUN TUBES AND NOZZLES

1. Replace worn contact tips as required.
1. Remove spatter from inside of gas nozzle and from tip after each 10 minutes of arc time or as required.

GUN CABLE CLEANING

To help prevent feeding problems, clean cable liner after using approximately 300 pounds (136 kg) of electrode. Remove the cable from the wire feeder and lay it out straight on the floor. Remove the contact tip from the gun. Using an air hose and only partial pressure, gently blow out the cable liner from the gas diffuser end.

Excessive pressure at the beginning of the cleaning procedure may cause the dirt to form a plug.

Flex the cable over its entire length and again blow out the cable. Repeat this procedure until no further dirt comes out. If this has been done and feed problems are experienced, replace the liner.



CAUTION

PERIODIC MAINTENANCE

LINER REMOVAL, INSTALLATION AND TRIMMING INSTRUCTIONS FOR MAGNUM PRO 100L

NOTE: The variation in cable lengths prevents interchanging of liners between guns. Once a liner has been cut for a particular gun, it should not be installed in another gun unless it can meet the liner cutoff length requirement.

1. Remove the gas nozzle from the gun by unscrewing counter-clockwise
2. Remove the contact tip from the gun by unscrewing counter-clockwise
3. Remove the gas diffuser from the gun tube by unscrewing counter-clockwise.
4. Lay the gun and cable out straight on a flat surface. Loosen the set screw located in the brass connector at the wire feeder end of the cable. Pull the liner out of the cable.
5. Insert a new untrimmed liner into the connector end of the cable. Be sure the liner bushing is stenciled appropriately for the wire size being used.
6. Fully seat the liner bushing into the connector. Tighten the set screw on the brass cable connector. At this time, the gas diffuser should not be installed onto the end of the gun tube.
7. With the gas nozzle and diffuser removed from the gun tube, be sure the cable is straight, and then trim the liner to the length shown in the Figure D.2. Remove any burrs from the end of the liner.
8. Screw the gas diffuser onto the end of the gun tube and securely tighten.
9. Replace the contact tip and nozzle.

FIGURE E.1

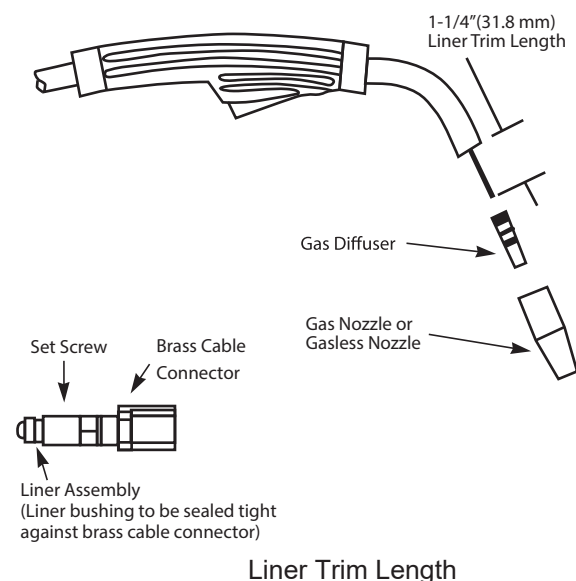

If for any reason you do not understand the procedures or are unable to perform the maintenance or repairs safely, contact your Lincoln Authorized Service Facility for technical troubleshooting assistance before you proceed.

WWW.LINCOLNELECTRIC.COM/LOCATOR

HOW TO USE TROUBLESHOOTING GUIDE



WARNING

Service and Repair should only be performed by Lincoln Electric Factory Trained Personnel. Unauthorized repairs performed on this equipment may result in danger to the technician and machine operator and will invalidate your factory warranty. For your safety and to avoid Electrical Shock, please observe all safety notes and precautions detailed throughout this manual.

Capacitor Discharge Procedure:

Do not operate with panels removed. Before servicing or installing kits, disconnect machine from power and wait a minimum of three minutes prior to removing sheet metal.

This Troubleshooting Guide is provided to help you locate and repair possible machine malfunctions. Simply follow the three-step procedure listed below.

Step 1. LOCATE PROBLEM (SYMPTOM).

Look under the column labeled "PROBLEM (SYMPTOMS)". This column describes possible symptoms that the machine may exhibit. Find the listing that best describes the symptom that the machine is exhibiting.

Step 2. POSSIBLE CAUSE.

The second column labeled "POSSIBLE CAUSE" lists the obvious external possibilities that may contribute to the machine symptom.

Step 3. RECOMMENDED COURSE OF ACTION

This column provides a course of action for the Possible Cause, generally it states to contact your local Lincoln Authorized Field Service Facility.

If you do not understand or are unable to perform the Recommended Course of Action safely, contact your local Lincoln Authorized Field Service Facility.



CAUTION

If for any reason you do not understand the test procedures or are unable to perform the tests/repairs safely, contact your **Local Lincoln Authorized Field Service Facility** for technical troubleshooting assistance before you proceed.

Observe all Safety Guidelines detailed throughout this manual

PROBLEMS (SYMPTOMS)	POSSIBLE CAUSE	RECOMMENDED COURSE OF ACTION
Major physical or electrical damage is evident.	"Do not Plug in machine or turn it on." Contact your local Authorized Field Service Facility.	If all recommended possible areas of mis-adjustment have been checked and the problem persists, Contact your local Lincoln Authorized Field Service Facility.
No wire feed, weld output or gas flow when gun trigger is pulled. Fan does NOT operate.	<ol style="list-style-type: none"> 1. Make sure correct voltage is applied to the machine. 2. Make certain that power switch is in the ON position. 3. Make sure circuit breaker is reset. 	
No wire feed, weld output or gas flow when gun trigger is pulled. Fan operates normally.	<ol style="list-style-type: none"> 1. The thermostat may be tripped due to overheating. Let machine cool. Weld at lower duty cycle. 2. Check for obstructions in air flow. Check Gun Trigger connections. See installation section. 3. Gun trigger may be faulty. 	
No wire feed when gun trigger is pulled. Fan runs, gas flows and machine has correct open circuit voltage - weld output.	<ol style="list-style-type: none"> 1. If the wire drive motor is running make sure that the correct drive rolls are installed in the machine. 2. Check for clogged cable liner or contact tip. 3. Check for proper size cable liner and contact tip. 4. Check if the spool gun switch, located in the wire drive compartment, is set to the desired location. 	
Low or no gas flow when gun trigger is pulled. Wire feed, weld output and fan operate normally.	<ol style="list-style-type: none"> 1. Check gas supply, flow regulator and gas hoses. 2. Check gun connection to machine for obstruction or leaky machine. 	

 **CAUTION**

If for any reason you do not understand the test procedures or are unable to perform the tests/repairs safely, contact your **Local Lincoln Authorized Field Service Facility** for technical troubleshooting assistance before you proceed.

Observe all Safety Guidelines detailed throughout this manual

PROBLEMS (SYMPTOMS)	POSSIBLE CAUSE	RECOMMENDED COURSE OF ACTION
Arc is unstable - Poor starting.	<ol style="list-style-type: none"> 1. Check for correct input voltage to machine. 2. Check for proper electrode polarity for process. 3. Check gun tip for wear or damage and proper size - Replace. 4. Check for proper gas and flow rate for process. (For MIG only.) 5. Check work cable for loose or faulty connections. 6. Check gun for damage or breaks. 7. Check for proper drive roll orientation and alignment. 8. Check liner for proper size. 	<p>If all recommended possible areas of misadjustment have been checked and the problem persists, Contact your local Lincoln Authorized Field Service Facility.</p>

 **CAUTION**

If for any reason you do not understand the test procedures or are unable to perform the tests/repairs safely, contact your **Local Lincoln Authorized Field Service Facility** for technical troubleshooting assistance before you proceed.

POWER MIG 211i WIRING DIAGRAM

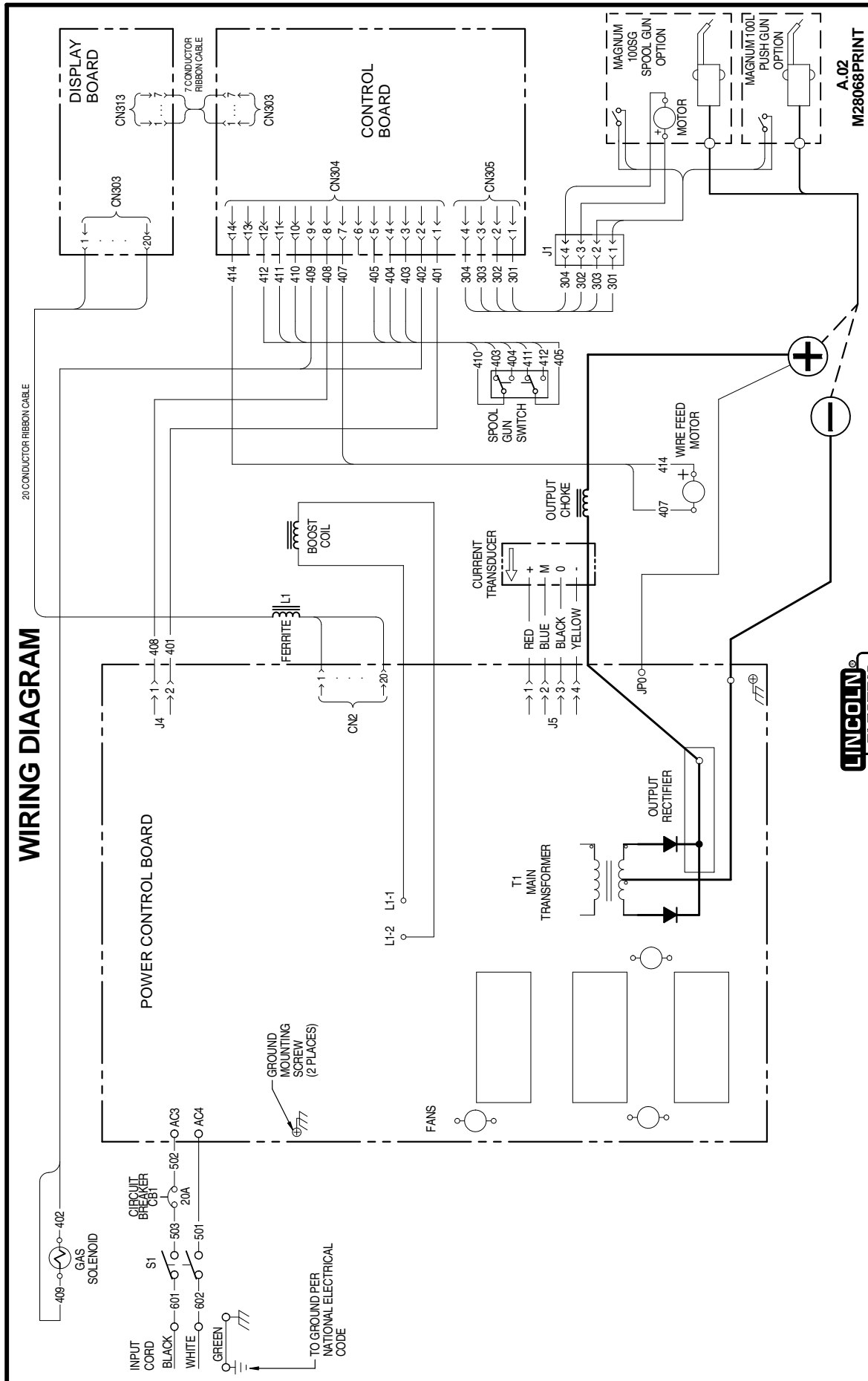

NOTE: This diagram is for reference only. It may not be accurate for all machines covered by this manual. The specific diagram for a particular code is pasted inside the machine on one of the enclosure panels. If the diagram is illegible, write to the Service Department for a replacement. Give the equipment code number.

POWER MIG 211i DIMENSION PRINT

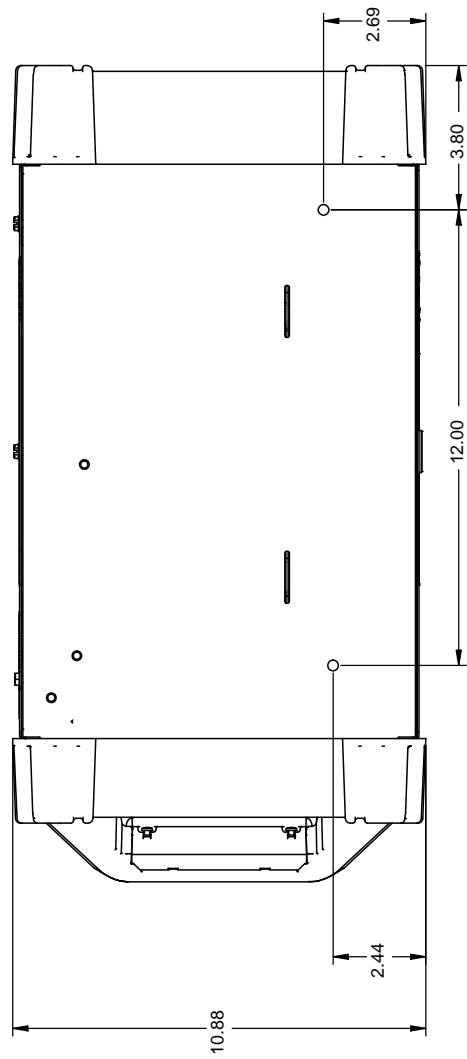
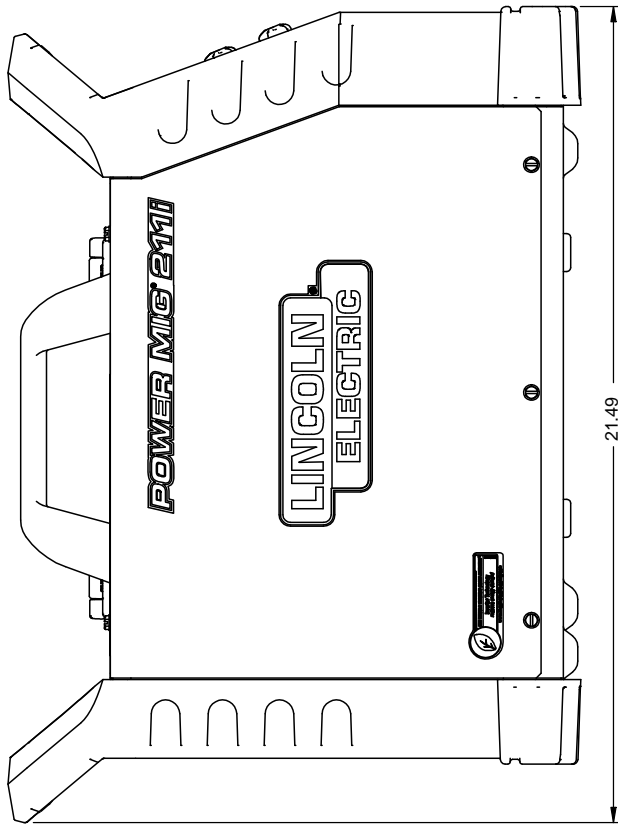
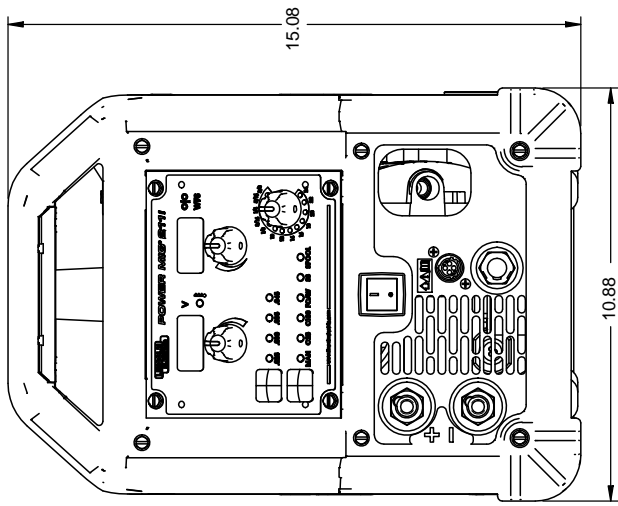

This page intentionally left blank.

			
WARNING	<ul style="list-style-type: none"> Do not touch electrically live parts or electrode with skin or wet clothing. Insulate yourself from work and ground. 	<ul style="list-style-type: none"> Keep flammable materials away. 	<ul style="list-style-type: none"> Wear eye, ear and body protection.
Spanish AVISO DE PRECAUCION	<ul style="list-style-type: none"> No toque las partes o los electrodos bajo carga con la piel o ropa mojada. Aíslese del trabajo y de la tierra. 	<ul style="list-style-type: none"> Mantenga el material combustible fuera del área de trabajo. 	<ul style="list-style-type: none"> Protéjase los ojos, los oídos y el cuerpo.
French ATTENTION	<ul style="list-style-type: none"> Ne laissez ni la peau ni des vêtements mouillés entrer en contact avec des pièces sous tension. Isolez-vous du travail et de la terre. 	<ul style="list-style-type: none"> Gardez à l'écart de tout matériel inflammable. 	<ul style="list-style-type: none"> Protégez vos yeux, vos oreilles et votre corps.
German WARNUNG	<ul style="list-style-type: none"> Berühren Sie keine stromführenden Teile oder Elektroden mit Ihrem Körper oder feuchter Kleidung! Isolieren Sie sich von den Elektroden und dem Erdboden! 	<ul style="list-style-type: none"> Entfernen Sie brennbares Material! 	<ul style="list-style-type: none"> Tragen Sie Augen-, Ohren- und Körperschutz!
Portuguese ATENÇÃO	<ul style="list-style-type: none"> Não toque partes elétricas e electrodos com a pele ou roupa molhada. Isole-se da peça e terra. 	<ul style="list-style-type: none"> Mantenha inflamáveis bem guardados. 	<ul style="list-style-type: none"> Use proteção para a vista, ouvido e corpo.
Japanese 注意事項	<ul style="list-style-type: none"> 通電中の電気部品、又は溶材にヒフやぬれた布で触れないこと。 施工物やアースから身体が絶縁されている様にして下さい。 	<ul style="list-style-type: none"> 燃えやすいものの側での溶接作業は絶対にしてはなりません。 	<ul style="list-style-type: none"> 目、耳及び身体に保護具をして下さい。
Chinese 警告	<ul style="list-style-type: none"> 皮肤或湿衣物切勿接触带电部件及焊条。 使你自己与地面和工作件绝缘。 	<ul style="list-style-type: none"> 把一切易燃物品移离工作场所。 	<ul style="list-style-type: none"> 佩戴眼、耳及身体劳动保护用具。
Korean 위험	<ul style="list-style-type: none"> 전도체나 용접봉을 젖은 형갑 또는 피부로 절대 접촉치 마십시오. 모재와 접지를 접촉치 마십시오. 	<ul style="list-style-type: none"> 인화성 물질을 접근시키지 마십시오. 	<ul style="list-style-type: none"> 눈, 귀와 몸에 보호장구를 착용하십시오.
Arabic تحذير	<ul style="list-style-type: none"> لا تلمس الاجزاء التي يسري فيها التيار الكهربائي أو الألكترود بجسدك أو بالملابس المبللة بالماء. ضع عازلا على جسمك خلال العمل. 	<ul style="list-style-type: none"> ضع المواد القابلة للاشتعال في مكان بعيد. 	<ul style="list-style-type: none"> ضع أدوات وملابس واقية على عينيك وأذنيك وجسمك.

READ AND UNDERSTAND THE MANUFACTURER'S INSTRUCTION FOR THIS EQUIPMENT AND THE CONSUMABLES TO BE USED AND FOLLOW YOUR EMPLOYER'S SAFETY PRACTICES.

SE RECOMIENDA LEER Y ENTENDER LAS INSTRUCCIONES DEL FABRICANTE PARA EL USO DE ESTE EQUIPO Y LOS CONSUMIBLES QUE VA A UTILIZAR, SIGA LAS MEDIDAS DE SEGURIDAD DE SU SUPERVISOR.

LISEZ ET COMPRENEZ LES INSTRUCTIONS DU FABRICANT EN CE QUI REGARDE CET EQUIPMENT ET LES PRODUITS A ETRE EMPLOYES ET SUIVEZ LES PROCEDURES DE SECURITE DE VOTRE EMPLOYEUR.

LESEN SIE UND BEFOLGEN SIE DIE BETRIEBSANLEITUNG DER ANLAGE UND DEN ELEKTRODENEINSATZ DES HERSTELLERS. DIE UNFALLVERHÜTUNGSVORSCHRIFTEN DES ARBEITGEBERS SIND EBENFALLS ZU BEACHTEN.

			
<ul style="list-style-type: none"> ● Keep your head out of fumes. ● Use ventilation or exhaust to remove fumes from breathing zone. 	<ul style="list-style-type: none"> ● Turn power off before servicing. 	<ul style="list-style-type: none"> ● Do not operate with panel open or guards off. 	WARNING
<ul style="list-style-type: none"> ● Los humos fuera de la zona de respiración. ● Mantenga la cabeza fuera de los humos. Utilice ventilación o aspiración para gases. 	<ul style="list-style-type: none"> ● Desconectar el cable de alimentación de poder de la máquina antes de iniciar cualquier servicio. 	<ul style="list-style-type: none"> ● No operar con panel abierto o guardas quitadas. 	Spanish AVISO DE PRECAUCION
<ul style="list-style-type: none"> ● Gardez la tête à l'écart des fumées. ● Utilisez un ventilateur ou un aspirateur pour ôter les fumées des zones de travail. 	<ul style="list-style-type: none"> ● Débranchez le courant avant l'entretien. 	<ul style="list-style-type: none"> ● N'opérez pas avec les panneaux ouverts ou avec les dispositifs de protection enlevés. 	French ATTENTION
<ul style="list-style-type: none"> ● Vermeiden Sie das Einatmen von Schweißrauch! ● Sorgen Sie für gute Be- und Entlüftung des Arbeitsplatzes! 	<ul style="list-style-type: none"> ● Strom vor Wartungsarbeiten abschalten! (Netzstrom völlig öffnen; Maschine anhalten!) 	<ul style="list-style-type: none"> ● Anlage nie ohne Schutzgehäuse oder Innenschutzverkleidung in Betrieb setzen! 	German WARNUNG
<ul style="list-style-type: none"> ● Mantenha seu rosto da fumaça. ● Use ventilação e exaustão para remover fumo da zona respiratória. 	<ul style="list-style-type: none"> ● Não opere com as tampas removidas. ● Desligue a corrente antes de fazer serviço. ● Não toque as partes elétricas nuas. 	<ul style="list-style-type: none"> ● Mantenha-se afastado das partes moventes. ● Não opere com os painéis abertos ou guardas removidas. 	Portuguese ATENÇÃO
<ul style="list-style-type: none"> ● ヒュームから頭を離すようにして下さい。 ● 換気や排煙に十分留意して下さい。 	<ul style="list-style-type: none"> ● メンテナンス・サービスに取りかかる際には、まず電源スイッチを必ず切して下さい。 	<ul style="list-style-type: none"> ● パネルやカバーを取り外したままで機械操作をしないで下さい。 	Japanese 注意事項
<ul style="list-style-type: none"> ● 頭部遠離煙霧。 ● 在呼吸區使用通風或排風器除煙。 	<ul style="list-style-type: none"> ● 維修前切斷電源。 	<ul style="list-style-type: none"> ● 儀表板打開或沒有安全罩時不準作業。 	Chinese 警告
<ul style="list-style-type: none"> ● 얼굴로부터 용접가스를 멀리하십시오. ● 호흡지역으로부터 용접가스를 제거하기 위해 가스제거기나 통풍기를 사용하십시오. 	<ul style="list-style-type: none"> ● 보수전에 전원을 차단하십시오. 	<ul style="list-style-type: none"> ● 판넬이 열린 상태로 작동치 마십시오. 	Korean 위험
<ul style="list-style-type: none"> ● ابعد رأسك بعيداً عن الدخان. ● استعمل التهوية أو جهاز ضغط الدخان للخارج لكي تبعد الدخان عن المنطقة التي تتنفس فيها. 	<ul style="list-style-type: none"> ● اقطع التيار الكهربائي قبل القيام بأية صيانة. 	<ul style="list-style-type: none"> ● لا تشغيل هذا الجهاز اذا كانت الاغطية الحديدية الواقية ليست عليه. 	Arabic تحذير

LEIA E COMPREENDA AS INSTRUÇÕES DO FABRICANTE PARA ESTE EQUIPAMENTO E AS PARTES DE USO, E SIGA AS PRÁTICAS DE SEGURANÇA DO EMPREGADOR.

使う機械や溶材のメーカーの指示書をよく読み、まず理解して下さい。そして貴社の安全規定に従って下さい。

請詳細閱讀並理解製造廠提供的說明以及應該使用的銀焊材料，並請遵守貴方的有閣勞動保護規定。

이 제품에 동봉된 작업지침서를 숙지하시고 귀사의 작업자 안전수칙을 준수하시기 바랍니다.

اقرأ بتمعن وافهم تعليمات المصنع المنتج لهذه المعدات والمواد قبل استعمالها واتبع تعليمات الوقاية لصاحب العمل.

CUSTOMER ASSISTANCE POLICY

The business of Lincoln Electric is manufacturing and selling high quality welding equipment, automated welding systems, consumables, and cutting equipment. Our challenge is to meet the needs of our customers, who are experts in their fields, and to exceed their expectations. On occasion, purchasers may ask Lincoln Electric for information or technical information about their use of our products. Our employees respond to inquiries to the best of their ability based on information and specifications provided to them by the customers and the knowledge they may have concerning the application. Our employees, however, are not in a position to verify the information provided or to evaluate the engineering requirements for the particular weldment, or to provide engineering advice in relation to a specific situation or application. Accordingly, Lincoln Electric does not warrant or guarantee or assume any liability with respect to such information or communications. Moreover, the provision of such information or technical information does not create, expand, or alter any warranty on our products. Any express or implied warranty that might arise from the information or technical information, including any implied warranty of merchantability or any warranty of fitness for any customers' particular purpose or any other equivalent or similar warranty is specifically disclaimed.

Lincoln Electric is a responsive manufacturer, but the definition of specifications, and the selection and use of specific products sold by Lincoln Electric is solely within the control of, and remains the sole responsibility of the customer. Many variables beyond the control of Lincoln Electric affect the results obtained in applying these types of fabrication methods and service requirements.

WELD FUME CONTROL EQUIPMENT

The operation of welding fume control equipment is affected by various factors including proper use and positioning of the equipment, maintenance of the equipment and the specific welding procedure and application involved. Worker exposure level should be checked upon installation and periodically thereafter to be certain it is within applicable OSHA PEL and ACGIH TLV limits.



THE LINCOLN ELECTRIC COMPANY

22801 St. Clair Avenue • Cleveland, OH • 44117-1199 • U.S.A.
Phone: +1.216.481.8100 • www.lincolnelectric.com