

# MAGNUM<sup>®</sup> PRO Selection Guide

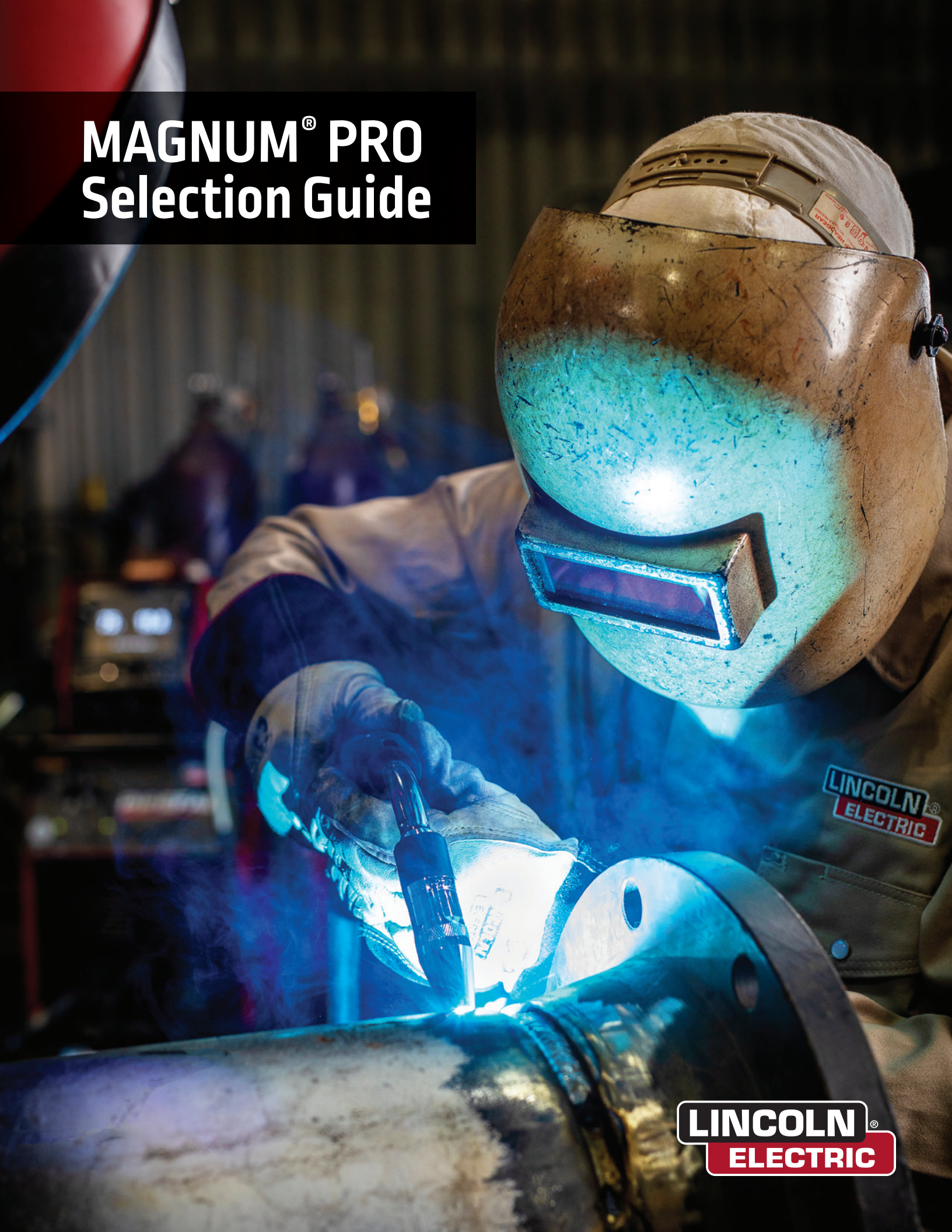

LINCOLN<sup>®</sup>  
ELECTRIC

LINCOLN<sup>®</sup>  
ELECTRIC

# Why Lincoln Electric?

## Providing solutions for industry-leading, global partners.

What makes Lincoln Electric the supplier of choice for the many industries we serve? A proven track record with over a century of experience in cutting-edge products, comprehensive welding processes and automated solutions. Our team of experts will work with you to find the best way to weld that fits your specific requirements and helps you achieve a favorable return on your investment. Wondering exactly what we can do for you? Let us show you.

## Why Magnum PRO?



Magnum PRO welding guns and expendables are built to withstand the toughest of welding environments. Their long lasting expendables help reduce downtime, increase throughput and save money while ensuring your welding gun stays cool to the touch. Designed with operator comfort and welding efficiency in mind, there is a Magnum PRO welding gun solution for any job!



**SAVE  
MONEY**



**INCREASE  
PART LIFE**



**DESIGNED FOR  
COMFORT**



**INCREASE  
PRODUCTIVITY**

## Table of Contents

3 – Industry Segment Solutions	25 – Magnum PRO Push-Pull Guns
5 – How To Select A Welding Gun	26 – Push vs. Push-Pull Overview
9 – Magnum PRO Semi-Automatic Welding Guns	27 – Magnum PRO 300 AL Push Guns
10 – Semi-Automatic Welding Gun Overview	28 – Magnum PRO AL FC Push-Pull Guns
11 – Magnum PRO L Series Welding Guns	29 – Magnum PRO Pistol Grip Push-Pull Guns
12 – Magnum PRO HDE Series Welding Guns	30 – Magnum PRO Expendables
14 – Magnum PRO Curve Series Welding Guns	31 – Magnum PRO Expendables Overview
16 – Magnum PRO Barrel Series Welding Guns	32 – Magnum PRO Copper Plus Contact Tips
18 – Magnum PRO Water-Cooled Welding Guns	33 – Magnum PRO Gas Nozzles
20 – K126 PRO Innershield Guns	34 – Magnum PRO Gas Diffusers
21 – Magnum PRO Spool Guns	35 – Magnum PRO Gun Tubes
22 – Magnum PRO 100SG Spool Guns	37 – Magnum PRO Cable Liners & Insulators
23 – Magnum PRO 250LX Spool Guns	
24 – Magnum PRO 250LX GT Spool Guns	

# Magnum PRO Semi-Automatic Industry Segment Solutions



## General Fabrication

There are many possibilities for welding guns to use in this space, but the best in class **Magnum PRO HDE** welding guns will provide premium performance with extreme focus on operator comfort to tackle those long shifts.

**Magnum PRO Curve HDE & Magnum PRO Barrel HDE**  
 K4532 Series - Curve  
 K4857 Series - Barrel



## Heavy Fabrication

Keep your welding gun cool by adding a **Magnum PRO Water-Cooled** welding gun to your set up. These high amperage duty cycle guns will allow you to use solutions such as HyperFill to increase productivity and throughput in your facility.

**Magnum PRO Curve & Magnum PRO Barrel 500 Water-Cooled**  
 K4522 Series - Curve  
 K4879 Series - Barrel



## Structural

When welding in the field, the use of the **K126 PRO Innershield** gun is preferred in order to avoid dealing with shielding gas. If your application is further upstream in the structural industry process, the use of the HyperFill solution with a **Magnum PRO Water-Cooled** welding gun could replace some submerged arc welding set ups.

**HyperFill Parts:**  
 KP4482 Series – Contact Tips  
 KP4481-1 – Gas Diffuser

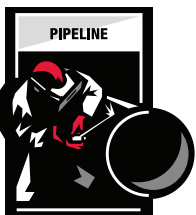

## Pipeline

Looking to reduce stops and starts and increase productivity? Try out the **K126 PRO Innershield** welding guns. These semi-automatic FCAW-SS welding guns can replace the use of SMAW electrodes without the need for shielding gas.

**K126 PRO Innershield Gun**  
 K126 Series – Innershield

**HD Insulator**  
 KP4897-1





## Shipbuilding

Carrying a heavy welding gun around the shipyard is undesirable over long shifts. Use our **Magnum PRO HDE** welding guns to maximize operator comfort without sacrificing performance.

### Magnum PRO Curve HDE & Magnum PRO Barrel HDE

K4532 Series - Curve  
K4857 Series - Barrel



K4531 Series – 250 Curve  
K4856 Series – 250 Barrel



## Process Industries

Get the perfect root pass by pairing the **Magnum PRO HDE** welding guns with a tapered Magnum PRO nozzle. The lower amperage, high duty cycle 250A HDE guns are lightweight and perfect for welding that STT root pass.

### STT Expendables

KP2744 Series – Tapered Tips  
KP2742 Series – Tapered Nozzles



## Offshore & Power Generation

Although a lot of welding in the Power Generation industry is done using a submerged arc process, Lincoln Electric's HyperFill application can be paired with the **Magnum PRO Water-Cooled** welding guns to get the high deposition welds needed.

### Magnum PRO Curve & Magnum PRO Barrel 500 Water-Cooled

K4522 Series - Curve  
K4879 Series – Barrel



### HyperFill Parts:

KP4482 Series – Contact Tips  
KP4481-1 – Gas Diffuser



## Maintenance & Repair

Get your parts back up and running with the use of the **Magnum PRO L Series** welding guns. These lightweight guns are easy to move around your facility ensuring you will get the job done quickly.

### Magnum PRO 100L, 175L & 250L

K4528 Series – 100L  
K4529 Series – 175L  
K4530 Series – 250L



# How To Select A Welding Gun

Selecting a welding gun can seem overwhelming but when broken down into a few questions, it can be turned into a fairly easy process! This selection guide will walk you through these questions to help determine which welding gun configuration is right for your application.

- 1. Amperage & Duty Cycle
- 2. Handle Style
- 3. Cable Length
- 4. Wire Diameter Range
- 5. Equipment Compatibility
- 6. Ready Pak Options

## Air-Cooled vs. Water-Cooled Guns

### Question:

**What amperage and duty cycle does your welding procedure require?**

Choosing between an Air-Cooled and Water-Cooled gun can be as simple as looking at the welding procedure specifications. Typically, welding application around or above 450-500A will begin to reach into the water-cooled welding gun territory.

Duty Cycle can also help choose between the different Magnum PRO family offerings. Each family will vary in duty cycle capabilities and knowing what your application requires will help make the decision.

**Magnum PRO Air-Cooled Semi-Automatic Guns – 100-550 A**  
**Magnum PRO Water-Cooled Semi-Automatic Guns – 400+ A**

Magnum PRO Family	Cooling Type	Amperage Range	Duty Cycle
Magnum PRO L Series	Air	100-250 A	100% Mixed Gas
Magnum PRO Curve Series		200-400 A	60% CO <sub>2</sub> /50% Mixed Gas
Magnum PRO Barrel Series		250-550 A	100% CO <sub>2</sub> /80% Mixed Gas
Magnum PRO HDE Series		250-500 A	100% Mixed Gas
Magnum PRO WC Series	Water	400-500 A	100% Mixed Gas



# Welding Gun Handle Style

## Question:

**Do you or your operators have a handle preference?**

There are typically 2 types of handle styles, curve or barrel. Although there can be benefits to choosing one handle style over another, it usually comes down to operator preference.

### Curve Style Handle

Curved handles are shaped to fit comfortably in the shape of your hand. When welding trigger on bottom, these handles can improve operator comfort and ergonomics.

### Barrel Style Handle

Barrel handles are shaped into a straight line and can provide added versatility to gun tube placement. When the gun tube is turned 180 degrees, a barrel handle welding gun can be used in the trigger on top configuration.

# Welding Gun Cable Length

## Question:

**How far away from your equipment is the weld joint located?**

Most Magnum PRO welding guns are offered in a variety of cable lengths. This provides flexibility in equipment placement relative to the weld piece. In some instances it makes sense to choose a shorter cable for better cable management, and other times a longer cable is needed to reach further distances. Standard cable lengths include 10, 15, 20 and 25 ft.

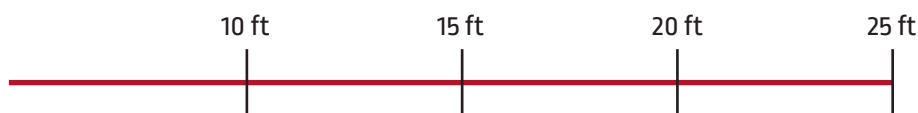

# Wire Diameter Range

## Question:

**What wire diameters are you typically running?**

Welding guns require the use of a cable liner which helps consistently feed the wire from the feeder to the weld joint. To ensure proper feeding, liners should be sized to the wire diameter.

Wire diameter size will also help determine contact tip size. Tips are sold in a variety of styles and sizes. They are labeled by diameter size and should match the wire size.

\*Refer to table on page 37

# Equipment Compatibility

## Question:

**What Equipment will the welding gun be run off of?**

Magnum PRO Welding Guns are compatible with most welding manufacturer's equipment with the quick, easy switch of the backend connector. Knowing which connector is needed can seem overwhelming but the table below outlines the various different Lincoln Electric connector kits and which equipment manufacturers they are compatible with.

Manufacturer	Equipment	Connector Kits used with KP44 Series Liners						Connector Kits used with KP45 Series Liners				
		K466-1	K466-2	K466-3	K466-6	K466-8	K466-10	K613-1	K613-2	K613-3	K613-6	K613-7
Lincoln Electric	POWER MIG 256				•							
	POWER MIG 260				•							
	POWER MIG 360MP				•							
	PIPEFAB						•					•
	Power Wave 300C				•							
	Power Feed Series						•					•
	DLF-82						•					•
	LF-72						•					•
	LF-74						•					•
	Flex Feed 74HT						•					•
	Activ8X						•					•
	Flex Feed 84						•					•
	LN-25X						•					•
	LN-25 PRO						•					•
	Activ8x Pipe						•					•
	LN-7	•							•			
	LN-8	•					•		•		•	
	LN-9	•					•		•		•	
LN-23P	•					•		•		•		
LN-25	•					•		•		•		
Tweco® Adapted	No. 2, No. 3, No. 4 Guns		•						•			
Miller®	Miller Equipment			•						•		

# Ready To Weld Solutions

## Question:

Would you rather purchase a ready to weld gun package?

Magnum PRO Ready Pak® Welding Guns take the process of building your own configuration out of the picture. By ordering one part number, you will receive a fully assembled welding gun which can be plugged into your equipment right out of the box!



## Ready-Pak Syntax:

# K4532-2-10-116

Welding Gun Family and Amperage Rating

Cable Length:

- 1 10ft
- 2 15ft
- 3 20ft
- 4 25ft

Connector Kit:

See Equipment Compatibility Table

Cable Liner and Contact Tip Diameter

## Connector Kits:

K466-1



K466-2

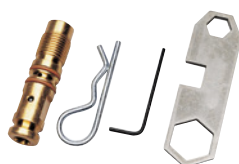

K466-3



K466-6



K466-8



K466-10



K613-1



K613-2



K613-3



K613-6



K613-7





# Magnum PRO Semi-Automatic Welding Guns



# Lincoln Electric Magnum<sup>®</sup> PRO

## SEMI-AUTOMATIC GUNS



Product Name	Magnum <sup>®</sup> PRO L-Series	Magnum <sup>®</sup> PRO Curve™	Magnum <sup>®</sup> PRO Barrel	Magnum <sup>®</sup> PRO Curve™ HDE™	Magnum <sup>®</sup> PRO Barrel HDE™
Part Numbers	K4528-1, K4529-1, K4530-2	K2950-X, K2951-X, K2952-X	K2651-X, K2652-X, K2653-X, K2655-X	K4531-X, K4532-X, K4533-X, K4534-X	K4856-X, K4857-X, K4858-X
CO2 Duty Cycle	100%	60%	100%	100%	100%
Mixed Gas Duty Cycle	100%	50-40%	80%	100%	100%
Amperage Range	100-250 A	200-400 A	250-550 A	250-550A	250-450A
Wire Diameter Range	.025 in - .045 in (0.6- 1.2 mm)	.025 in - 5/64 in (0.6- 2.0 mm)	.035 in - 1/8 in (0.9- 3.2 mm)	.025 in - 1/8 in (0.6- 3.2 mm)	.025 - 1/8 in (0.6-3.2 mm)
Handle Type	Curve	Curve	Barrel	Curve	Barrel
Handle Dimensions	Length: 6 in Diameter: 1 in	Length: 6 in Diameter: 1.5 in	Length: 9 in Diameter: 1.7 in	Length: 6.8 in - 7.3 in Diameter: 1 in - 1.6 in	Length: 8.3 - 8.6 in Diameter: 1.2 - 1.35 in
Lengths Available	10ft 15ft	10ft 15ft 20ft 25ft	10ft 15ft 20ft 25ft	10ft 15ft 20ft 25ft	10ft 15ft 20ft 25ft
Over Molded Grip	✓	—	—	✓	✓
Rotatable Gun Tube	—	Allen Wrench	Allen Wrench	Tool-Less	Tool-Less
Strain Relief	—	✓	✓	✓	✓
Magnum <sup>®</sup> PRO Expendables	✓	✓	✓	✓	✓
Target Industry	Home, Farm, Small Shop Projects, Auto Body Work, Maintenance and Repair	Shop Production, Maintenance and Repair, Construction	Industrial Fabrication, Heavy Equipment, Shipbuilding, Construction	Heavy Fabrication, General Fabrication, Pipe, Structural, Automotive/Transport	Heavy Fabrication, General Fabrication, Pipe, Structural, Shipbuilding

# Magnum PRO L Series Welding Guns

## LIGHT AND COMPACT

Magnum PRO L Series welding guns are the most lightweight, compact model in the Magnum PRO family. They are ideal for small shop projects, repair jobs and light maintenance work. Their 100% mixed gas duty cycle and premium features make them the right choice for your lower amperage applications!



Product Name	Product Number	Amperage Rating 100% Duty Cycle Mixed Gas	Wire Diameter Range in (mm)	Cable Length ft (m)	Equipment Compatibility
<b>Magnum PRO 100L</b>	K4528-1	100	0.025 - 0.045(0.6-1.2)	10 (3.0)	POWER MIG 140C, POWER MIG 180C, POWER MIG 180 Dual
	K4528-1-8P				POWER MIG 140 MP
	K4871-1				Miller Equipment
<b>Magnum PRO 175L</b>	K4529-1	175		15 (4.6)	POWER MIG 210 MP, POWER MIG 215 MPI
	K4872-1				Miller Equipment
<b>Magnum PRO 250L</b>	K4530-2	250		15 (4.6)	POWER MIG 256, POWER MIG 260
	K4873-2				Miller Equipment
	K4874-2				Lincoln Industrial Equipment (K466-10)

For more information see the L Series Welding Gun Spec Guides: [E12.31](#), [E12.32](#), [E12.33](#)

# Magnum PRO HDE Welding Guns

HEAVY DUTY. ERGONOMIC.

Magnum PRO HDE Series welding guns are the most durable and ergonomic semi-automatic MIG guns in the Magnum PRO family. Designed for rugged welding environments, the HDE product line offers the highest duty cycle rating in their class while maintaining focus on comfort driven features, making them a sure choice for your welders throughout a long days' shift!

**Premium Expendable Performance** – Lincoln Electric's patented Magnum PRO expendables are designed with both performance and productivity in mind. The premium performance helps extend the service life of the expendables, reducing downtime and total costs

**100% Mixed Gas Duty Cycle** – Withstands the toughest jobs while keeping the gun cool to the touch, making them ideal for high heat applications

**Versatile Gun Configurations** – Its 360° tool-less rotatable gun tube makes it easy to customize

**Enhanced Operator Comfort** – The over-molded handle design provides the operator with a secure grip on the gun and reduces hand fatigue

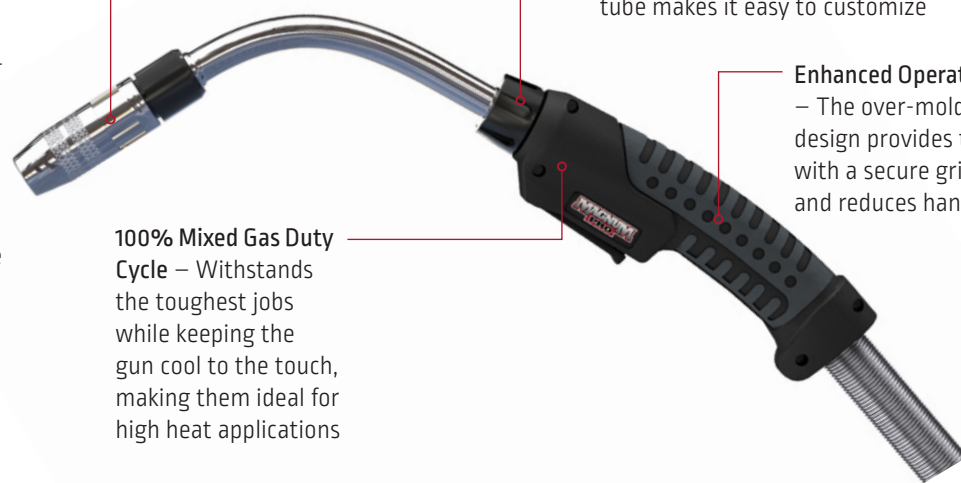

## Magnum PRO Curve HDE Guns vs. Magnum PRO Barrel HDE Guns:

The choice between the Curve style or Barrel style handle comes down to operator preference. Since both styles come with the same premium HDE features, you can experience increased operator comfort, productivity, and quality with whichever Magnum PRO HDE welding gun you choose.



### Curve vs. Barrel Handle Design:

	Magnum PRO Curve HDE	Magnum PRO Barrel HDE
100% Mixed Gas Duty Cycle	✓	✓
Amperage Classes	250/350/450/550	250/350/450
Tool-less Rotatable Gun Tube	✓	✓
Magnum PRO Expendables	✓	✓
Trigger Style	Standard	Paddle
Trigger On Top	-	✓
Over Molded Handle	✓	✓

For more information see the HDE Series Welding Gun Spec Guides: E12.390, E12.08, E12.08.1

**MAGNUM PRO CURVE HDE GUNS**

Product Name	Product Number	Amperage Rating 100% Duty Cycle Mixed Gas	Wire Diameter Range in (mm)	Cable Length ft (m)	Gun Tube	Gun Connector	Gun Liner
Magnum PRO Curve HDE 250	K4531-1	250	0.025 - 0.045 (0.6-1.2)	10 (3.0)	KP4693-60		
	K4531-2			15 (4.5)			
	K4531-3			20 (6.1)			
	K4531-4			25 (7.6)			
Magnum PRO Curve HDE 350	K4532-1	350	0.035 - 5/64 (0.9-2.0)	10 (3.0)	KP4694-60		
	K4532-2			15 (4.5)			
	K4532-3			20 (6.1)			
	K4532-4			25 (7.6)			
Magnum PRO Curve HDE 350 Dual Procedure	K5297-2			15 (4.5)			
	K5297-4			25 (7.6)			
Magnum PRO Curve HDE 350 Dual Schedule	K5298-2			15 (4.5)			
	K5298-4			25 (7.6)			
Magnum PRO Curve HDE 450	K4533-1	450	0.035 - 5/64 (0.9-2.0)	10 (3.0)	KP4695-60		
	K4533-2			15 (4.5)			
	K4533-3			20 (6.1)			
	K4533-4			25 (7.6)			
Magnum PRO Curve HDE 450 Dual Procedure	K5299-2			15 (4.5)			
	K5299-4			25 (7.6)			
Magnum PRO Curve HDE 450 Dual Schedule	K5300-2			15 (4.5)			
	K5300-4			25 (7.6)			
Magnum PRO Curve HDE 550	K4534-1	550	0.035 - 1/8 (0.9-3.2)	10 (3.0)	KP4696-60		
	K4534-2			15 (4.5)			
	K4534-3			20 (6.1)			
	K4534-4			25 (7.6)			
Magnum PRO Curve HDE 250 Ready-Pak	K4531-2-10-45	250	0.025 - 0.045 (0.6-1.2)	15 (4.5)	KP4693-60	K466-10	KP42-4045-15
	K4531-2-6-45					K466-6	KP42-4045-15
	K4531-2-3-45					K466-3	KP42-4045-15
	K4531-2-FM-45					Fast Mate	KP42-4045-15
	K4531-4-FM-45					Fast Mate	KP42-4045-25
Magnum PRO Curve HDE 350 Ready-Pak	K4532-2-10-45	350	0.035 - 5/64 (0.9-2.0)	15 (4.5)	KP4694-60	K466-10	KP44-3545-15
	K4532-2-6-45					K466-6	KP44-3545-15
	K4532-2-3-45					K466-3	KP44-3545-15
	K4532-2-1-45					K466-1	KP44-3545-15
	K4532-2-10-116					K466-10	KP44-116-15
	K4532-2-6-116					K466-6	KP44-116-15
	K4532-2-3-116					K466-3	KP44-116-15
	K4532-2-1-116					K466-1	KP44-116-15
	K4532-2-FM-45					Fast Mate	KP44-3545-15
	K4532-4-10-116					K466-10	KP44-116-25
	K4532-4-6-116					K466-6	KP44-116-25
	K4532-4-3-116					K466-3	KP44-116-25
	K4532-4-1-116					K466-1	KP44-116-25
	K4532-4-FM-45					Fast Mate	KP44-3545-25
Magnum PRO Curve HDE 450 Ready-Pak	K4533-2-10-564	450	0.035 - 5/64 (0.9-2.0)	15 (4.5)	KP4695-60	K466-10	KP44-564-15
	K4533-2-3-564				K466-3	KP44-564-15	
	K4533-2-7-332				KP4696-60SN	K613-7	KP45H-332-15
	K4533-2-3-332				K613-3	KP45H-332-15	
Magnum PRO Curve HDE 550 Ready-Pak	K4534-2-7-332	550	0.035 - 1/8 (0.9-3.2)	15 (4.5)	KP4696-60	K613-7	KP45H-332-15
	K4534-2-3-332					K613-3	KP45H-332-15

(1) The 450A gun can be adapted to run up to 1/8 in. wire by using a KP45 series liner, a K613 series backend, and a 550A or 550A short gooseneck. The original 450A gooseneck cannot be used on wire larger than 5/64 in.

(2) 0.035-0.045 liner included in Ready-Pak

(3) 0.052-1/16 liner included in Ready-Pak

(4) 1/16-5/64 liner included in Ready-Pak

(5) 5/64-3/32 liner included in Ready-Pak



**MAGNUM PRO BARREL HDE GUNS**

Product Name	Product Number	Amperage Rating 100% Duty Cycle Mixed Gas	Wire Diameter Range in (mm)	Cable Length ft (m)	Gun Tube	Gun Connector	Gun Liner
Magnum PRO Barrel HDE 250	K4856-1	250	0.025 - 0.045 (0.6-1.2)	10 (3.0)	KP4693-60		
	K4856-2			15 (4.5)			
	K4856-3			20 (6.1)			
	K4856-4			25 (7.6)			
Magnum PRO Barrel HDE 350	K4857-1	350	0.035 - 5/64 (0.9-2.0)	10 (3.0)	KP4694-60	Order Separately	Order Separately
	K4857-2			15 (4.5)			
	K4857-3			20 (6.1)			
	K4857-4			25 (7.6)			
Magnum PRO Barrel HDE 350 Dual Schedule	K5306-2			15 (4.5)			
	K5306-4			25 (7.6)			
Magnum PRO Barrel HDE 450	K4858-1	450	0.035 - 5/64 (0.9-2.0)	10 (3.0)	KP4695-60		
	K4858-2			15 (4.5)			
	K4858-3			20 (6.1)			
	K4858-4			25 (7.6)			
Magnum PRO Barrel HDE 450 Dual Schedule	K5308-2			15 (4.5)			
	K5308-4			25 (7.6)			
Magnum PRO Barrel HDE 250 Ready Pak	K4856-2-1-45	250	0.025 - 0.045 (0.6-1.2)	15 (4.5)	KP4693-60	K466-1	KP42-4045-15
	K4856-2-10-45					K466-10	KP42-4045-15
	K4856-2-3-45					K466-3	KP42-4045-15
	K4856-2-FM-45					Fast Mate	KP42-4045-15
	K4856-4-FM-45					Fast Mate	KP42-4045-25
Magnum PRO Barrel HDE 350 Ready Pak	K4857-2-1-116	350	0.035 - 5/64 (0.9-2.0)	15 (4.5)	KP4694-60	K466-1	KP44-116-15
	K4957-2-10-116					K466-10	KP44-116-15
	K4857-2-3-116					K466-3	KP44-116-15
	K4857-2-FM-45					Fast Mate	KP44-3545-15
	K4857-4-1-116			K466-1		KP44-116-25	
	K4857-4-10-116			K466-10		KP44-116-25	
	K4857-4-3-116			K466-3		KP44-116-25	
	K4857-4-FM-45			Fast Mate		KP44-3545-25	
Magnum PRO Barrel HDE 450 Ready Pak	K4858-2-1-564	450	0.035 - 5/64 (0.9-2.0)	15 (4.5)	KP4695-60	K466-1	KP45-564-15
	K4858-2-10-564					K466-10	KP45-564-15
	K4858-2-3-564					K466-3	KP45-564-15

(1) The 450A gun can be adapted to run up to 1/8 in. wire by using a KP45 series liner, a K613 series backend, and a 550A or 550A short gooseneck. The original 450A gooseneck cannot be used on wire larger than 5/64 in.  
 (2) 0.035-0.045 liner included in Ready-Pak

(3) 0.052-1/16 liner included in Ready-Pak  
 (4) 1/16-5/64 liner included in Ready-Pak  
 (5) 5/64-3/32 liner included in Ready-Pak



# Magnum PRO Curve Welding Guns

## LIGHTWEIGHT AND BALANCED

Magnum PRO Curve guns for MIG or flux-cored welding combine our classic curved handle with our Copper Plus contact tips and Magnum PRO gun expendables to deliver long hours of fabrication welding with less frequent tip and gun expendable parts changes.

**Premium Tip Performance**  
– Compatible with Magnum PRO Copper Plus Contact Tips keeping the front-end parts cool, extending tip, nozzle and diffuser life



**Rotating Gun Tube** –  
Allows for versatility in gun tube positioning to reduce fatigue or fit into tight spaces



**Curve Handle Design** – Our Curve handle is lightweight and balanced, providing a comfortable grip to reduce fatigue

**Industrial Grade Construction** –  
High quality copper parts ensure superior electrical contact and heat dissipation



### Dual Schedule vs. Dual Procedure Control:

Magnum PRO Curve Series welding guns offer remote procedure control with the use of either a dual schedule trigger or dual procedure switch.

Both options offer the ability to switch between two preset procedures between passes or on the fly!

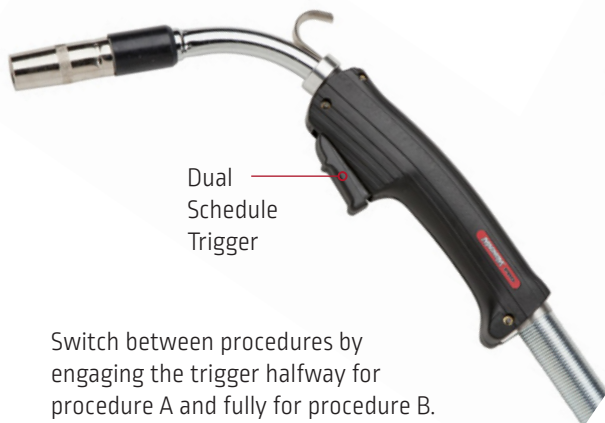

Dual Schedule Trigger

Switch between procedures by engaging the trigger halfway for procedure A and fully for procedure B.

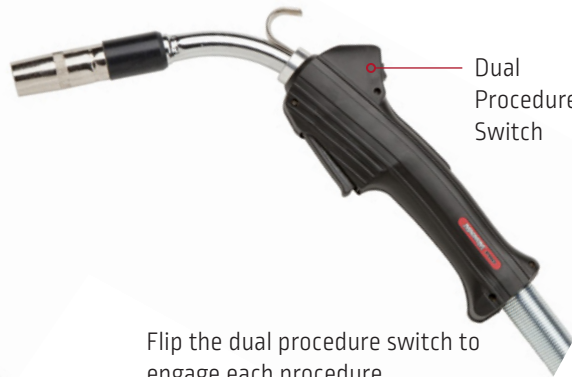

Dual Procedure Switch

Flip the dual procedure switch to engage each procedure.

For more information see the [Curve Series Welding Gun Spec Guide: E12.05](#)



**MAGNUM PRO CURVE GUNS**

Product Name	Product Number	Amperage Rating 100% Duty Cycle CO <sub>2</sub>	Wire Diameter Range in. (mm)	Cable Length ft. (m)	Gun Connector	Gun Liner	
Magnum® PRO Curve™ 200	K2950-1	200	.025 - 3/64	10 (3.0)	Order Separately	Order Separately	
	K2950-2			15 (4.5)			
Magnum® PRO Curve™ 300	K2951-1	300	.025 - 5/64	10 (3.0)			
	K2951-2			15 (4.5)			
	K2951-3			20 (6.1)			
	K2951-4			25 (7.6)			
Magnum® PRO Curve™ 300 Dual Procedure (Switch Control)	K3130-1	300	.025 - 5/64	10 (3.0)			
	K3130-2			15 (4.5)			
	K3130-3			20 (6.1)			
	K3130-4			25 (7.6)			
Magnum® PRO Curve™ 300 Dual Schedule (Trigger Control)	K3092-1	300	.025 - 5/64	10 (3.0)			
	K3092-2			15 (4.5)			
	K3092-3			20 (6.1)			
	K3092-4			25 (7.6)			
Magnum® PRO Curve™ 400	K2952-1	400	.025 - 5/64	10 (3.0)			
	K2952-2			15 (4.5)			
	K2952-3			20 (6.1)			
	K2952-4			25 (7.6)			
Magnum® PRO Curve™ 400 Dual Procedure (Switch Control)	K3098-1	400	.025 - 5/64	10 (3.0)			
	K3098-2			15 (4.5)			
	K3098-3			20 (6.1)			
	K3098-4			25 (7.6)			
Magnum® PRO Curve™ 400 Dual Schedule (Trigger Control)	K3093-1	400	.025 - 5/64	10 (3.0)			
	K3093-2			15 (4.5)			
	K3093-3			20 (6.1)			
	K3093-4			25 (7.6)			
Magnum® PRO Curve™ 400A Short Neck	K3055-1	400	.025 - 5/64	10 (3.0)			
	K3055-2			15 (4.5)			
	K3055-3			20 (6.1)			
	K3055-4			25 (7.6)			
Magnum PRO Curve 200 Ready-Pak	K2950-2-10-45	200	0.025 - 3/64 (0.6-1.2)	15 (4.5)	K466-10	KP42-4045-15	
	K2950-2-FM-45			Fast Mate	KP42-4045-15		
Magnum PRO Curve 300 Ready-Pak	K2951-2-6-45	300	0.025 - 5/64 (0.6-2.0)	15 (4.5)	K466-6	KP44-3545-15	
	K2951-2-10-45				K466-10	KP44-3545-15	
	K2951-2-10-116				K466-10	KP44-116-15	
	K2951-2-3-45				K466-3	KP44-3545-15	
	K2951-2-FM-45				Fast Mate	KP44-3545-15	
Magnum PRO Curve 400 Ready-Pak	K2952-2-10-45	400	0.025 - 5/64 (0.6-2.0)	15 (4.5)	K466-10	KP44-3545-15	
	K2952-2-10-45-550				K466-10	KP44-3545-15	
	K2952-2-3-45				K466-3	KP44-3545-15	
	K2952-2-3-45-550				K466-3	KP44-3545-15	
	K2952-2-6-45				K466-6	KP44-3545-15	
	K2952-2-FM-45				Fast Mate	KP44-3545-15	
	K2952-2-1-116-550				K466-1	KP44-116-15	
	K2952-2-1-564-550			K466-1	KP44-564-15		
	K2952-3-10-45-550			20 (6.1)	K466-10	KP44-3545-25	
	K2952-3-3-45				K466-3	KP44-3545-25	
	K2952-3-3-45-550				K466-3	KP44-3545-25	
	K2952-3-6-45				K466-6	KP44-3545-25	
	Magnum PRO Curve 400 Short Neck Ready-Pak				K3055-2-10-45	400	
K3055-2-6-45		K466-6	KP44-3545-15				
	K3055-3-6-45			20 (6.1)	K466-6	KP44-3545-25	

# Magnum PRO Barrel Welding Guns

## INDUSTRIAL GRADE CONSTRUCTION

Magnum® PRO guns for MIG and flux cored welding are specifically designed and tested for extreme environment welding applications. These guns are built for high amperage, high duty cycle applications where heat-resistance and fast serviceability are key.

**Premium Tip Performance**  
– Compatible with Magnum PRO Copper Plus Contact Tips keeping the front-end parts cool, extending tip, nozzle and diffuser life

**Rotating Gun Tube** – Use as a trigger on bottom or trigger on top welding gun by rotating the gun tube 180 degrees

**Comfort Grip Handle Design** – Ridges designed to provide a secure grip on the gun reducing hand fatigue over time

**Industrial Grade Construction** – High quality copper parts ensure superior electrical contact and heat dissipation

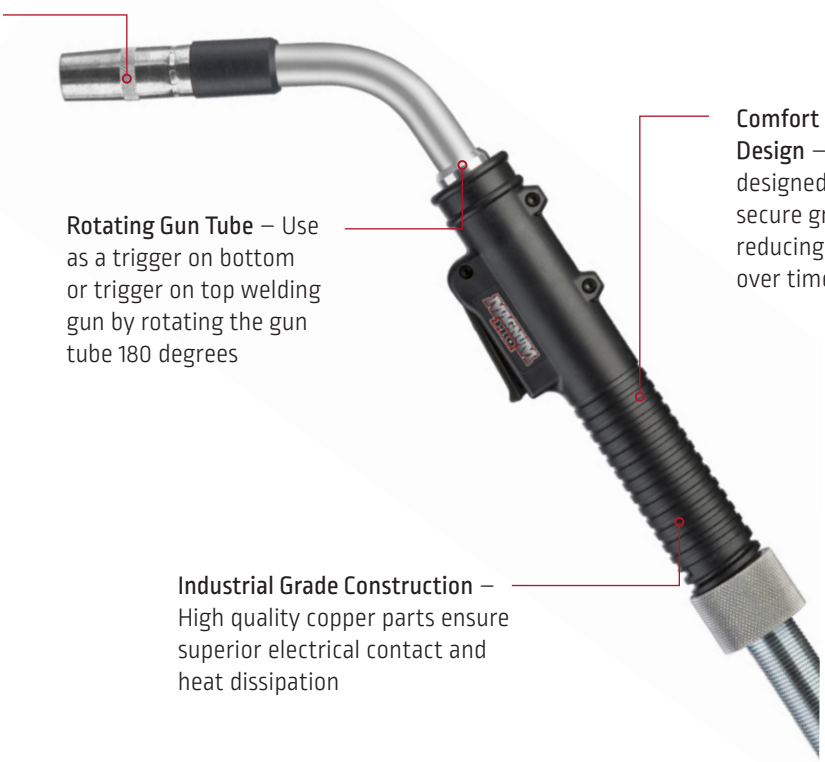

### Dual Schedule vs. Dual Procedure Control:

Magnum PRO Curve Series welding guns offer remote procedure control with the use of either a dual schedule trigger or dual procedure switch.

Both options offer the ability to switch between two preset procedures between passes or on the fly!

Dual Procedure Switch



Flip the dual procedure switch to engage each procedure.

Dual Schedule Trigger



Switch between procedures by engaging the trigger halfway for procedure A and fully for procedure B.

For more information see the [Barrel Series Welding Gun Spec Guide: E12.01](#)

**MAGNUM PRO BARREL GUNS**

Product Name	Product Number	Amperage Rating 60% Duty Cycle CO <sub>2</sub>	Wire Diameter Range in. (mm)	Cable Length ft. (m)	Gun Connector	Gun Liner		
Magnum PRO Barrel 250	K2651-1	250	0.035 - 5/64 (0.9-2.0)	10 (3.0)	Order Separately	Order Separately		
	K2651-2			15 (4.5)				
	K2651-3			20 (6.1)				
	K2651-4			25 (7.6)				
Magnum PRO Barrel 350	K2652-1	350	0.035 - 5/64 (0.9-2.0)	10 (3.0)				
	K2652-2			15 (4.5)				
	K2652-3			20 (6.1)				
	K2652-4			25 (7.6)				
Magnum PRO 350 Dual Procedure	K3131-1			350			0.035 - 5/64 (0.9-2.0)	10 (3.0)
	K3131-2							15 (4.5)
	K3131-3							20 (6.1)
	K3131-4							25 (7.6)
Magnum PRO 350 Dual Schedule	K3132-1			350			0.035 - 5/64 (0.9-2.0)	10 (3.0)
	K3132-2							15 (4.5)
	K3132-3							20 (6.1)
	K3132-4							25 (7.6)
Magnum PRO Barrel 450	K2653-1	450	0.035 - 5/64 (0.9-2.0)	10 (3.0)				
	K2653-2			15 (4.5)				
	K2653-3			20 (6.1)				
	K2653-4			25 (7.6)				
Magnum PRO 450 Dual Procedure	K3133-1			450			0.035 - 5/64 (0.9-2.0)	10 (3.0)
	K3133-2							15 (4.5)
	K3133-3							20 (6.1)
	K3133-4							25 (7.6)
Magnum PRO 450 Dual Schedule	K3134-1			450			0.035 - 5/64 (0.9-2.0)	10 (3.0)
	K3134-2							15 (4.5)
	K3134-3							20 (6.1)
	K3134-4							25 (7.6)
Magnum PRO Barrel 550	K2655-1			550	0.035 - 1/8 (0.9-3.2)	10 (3.0)		
	K2655-2					15 (4.5)		
	K2655-3					20 (6.1)		
	K2655-4					25 (7.6)		
Magnum PRO 550 Dual Procedure	K3135-1	550	0.035 - 1/8 (0.9-3.2)			10 (3.0)		
	K3135-2					15 (4.5)		
	K3135-3					20 (6.1)		
	K3135-4					25 (7.6)		
Magnum PRO 550 Dual Schedule	K3136-1	550	0.035 - 1/8 (0.9-3.2)			10 (3.0)		
	K3136-2					15 (4.5)		
	K3136-3					20 (6.1)		
	K3136-4					25 (7.6)		
Magnum PRO 250 Ready-Pak	K2651-2-6-45	250	0.035 - 5/64 (0.9-2.0)	15 (4.5)	K466-6	KP44-3545-15		
Magnum PRO 350 Ready-Pak	K2652-2-10-45	350			K466-10	KP44-3545-15		
Magnum PRO 450 Ready-Pak	K2653-2-10-45	450			K466-10	KP44-3545-15		

# Magnum PRO Water-Cooled Welding Guns

## IMPROVING COMFORT AND PERFORMANCE

Magnum® PRO guns for MIG and flux cored welding are specifically designed and tested for extreme environment welding applications. These guns are built for high amperage, high duty cycle applications where heat-resistance and fast serviceability are key.

**Expendables Built for High Heat** – Water-cooled goosenecks designed to keep the front-end parts cooler longer, extending expendable life and improving operator comfort

**100% Duty Cycle** – The 400A and 500A guns run at 100% duty cycle using 90/10 mixed gas, making them ideal for high heat applications

**HyperFill Solution** – Magnum PRO 500 Water-Cooled guns are a great solution for welding with HyperFill. Their high duty cycle and focus on operator comfort makes them ideal for the high heat application

**Over-Molded Handle Design** – Allows for a secure grip of the gun and is easier for the operator to control



### Curve vs. Barrel Handle Design:

	Magnum PRO Curve WC Guns	Magnum PRO Barrel WC Guns
100% Mixed Gas Duty Cycle	✓	✓
Amperage Classes	400/500	500
Trigger Style	Standard	Paddle
Trigger On Top	-	✓
Over Molded Handle	✓	✓
Dual Procedure Option	-	✓

For more information see the Water-Cooled Series Welding Gun Spec Guides: E12.06 & E12.380



Dual Procedure Control

**Dual Procedure Control:**

Magnum PRO Barrel Water-Cooled welding guns offer remote procedure control with the use a dual procedure switch.

The Dual Procedure Switch provides the ability to switch between two preset procedures between passes or on the fly!

**MAGNUM PRO WATER-COOLED GUNS**

Product Name	Product Number	Amperage Rating 100% Duty Cycle Mixed Gas	Wire Diameter Range in. (mm)	Cable Length ft. (m)	Gun Connector	Gun Liner			
Magnum PRO Curve 400 WC Gun	K4521-2-10-45	400	0.035 - 5/64 (0.9-2.0)	15 (4.5)	K466-10	KP44-3545-15			
	K4521-2-FM-45				Fast Mate				
Magnum PRO Curve 500 WC Gun	K4522-1-10-45	500		10 (3.0)	K466-10		KP44-3545-15		
	K4522-1-FM-45				Fast Mate				
	K4522-2-10-45			15 (4.5)	K466-10		KP44-564-15		
	K4522-2-FM-45				Fast Mate				
	K4522-2-10-564			20 (6.1)	K466-10	KP44-3545-25			
	K4522-3-10-45				Fast Mate				
	K4522-3-FM-45			25 (7.6)	K466-10	KP44-332-15			
	K4522-4-10-45				Fast Mate				
	K4885-2-10-332			15 (4.5)	K466-10	KP44-332-15			
	K4885-2-FM-332				Fast Mate				
Magnum PRO Barrel 500 WC Gun	K4879-2-10-564	500	0.035 - 5/64 (0.9-2.0)	15 (4.5)	K466-10	KP44-564-15			
	K4879-3-10-564						20 (6.1)		
	K4879-4-10-564						25 (7.6)		
Magnum PRO Barrel 500 WC Gun - with Dual Procedure Switch	K4880-2-10-564	500		0.035 - 5/64 (0.9-2.0)	15 (4.5)		K466-10	KP44-564-15	
	K4880-3-10-564								20 (6.1)
	K4880-4-10-564								25 (7.6)

# Magnum PRO LFG Fume Guns

## LIGHTWEIGHT FUME SOLUTION

The Magnum PRO Fume Guns provide a premium fume capture experience by placing focus on not only welding performance but also operator comfort. Its key features and innovative design make welding easy and comfortable throughout an entire shift!

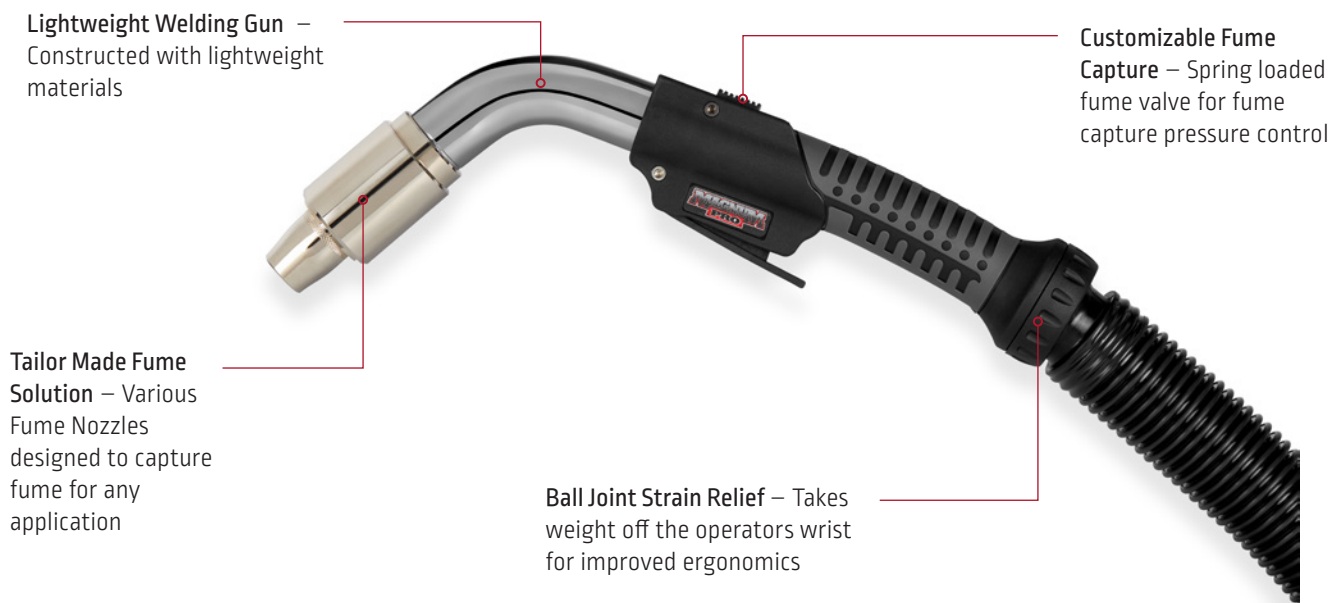

### MAGNUM PRO LFG FUME GUNS

Part Number	Amperage Rating 100% Duty Cycle CO <sub>2</sub>	Wire Diameter Range in (mm)	Cable Length ft (m)
K4464-2	350	0.035 - 0.052 (0.9-1.3)	15 (4.6)

### FUME EXTRACTION NOZZLE

Procedure	GMAW		FCAW Gas Shielded		FCAW Self Shielded		
	Flat / Horizontal	Vertical / Overhead	Flat / Horizontal	Vertical / Overhead	Flat / Horizontal	Vertical / Overhead	
Wire Diameter	0.030 -0.035	KP5430-2	KP5430-2	KP5430-3	KP5430-3	KP5430-4	KP5430-4
	0.040 -0.045						
	0.052						

For more information see the LFG Fume Gun Spec Guide: E12.402

# K126™ PRO Innershield Guns

## THE LEADER IN CONSTRUCTION WELDING GUNS

Lincoln Electric has been the leader in self-shielded wire, feeders and guns for more than 50 years. The new K126 PRO guns feature replaceable liners, interchangeable back ends, long life Magnum PRO contact tips, improved heat resistant gun tubes and better trigger lead protection. Select the Lincoln K126 PRO series for your construction welding applications.

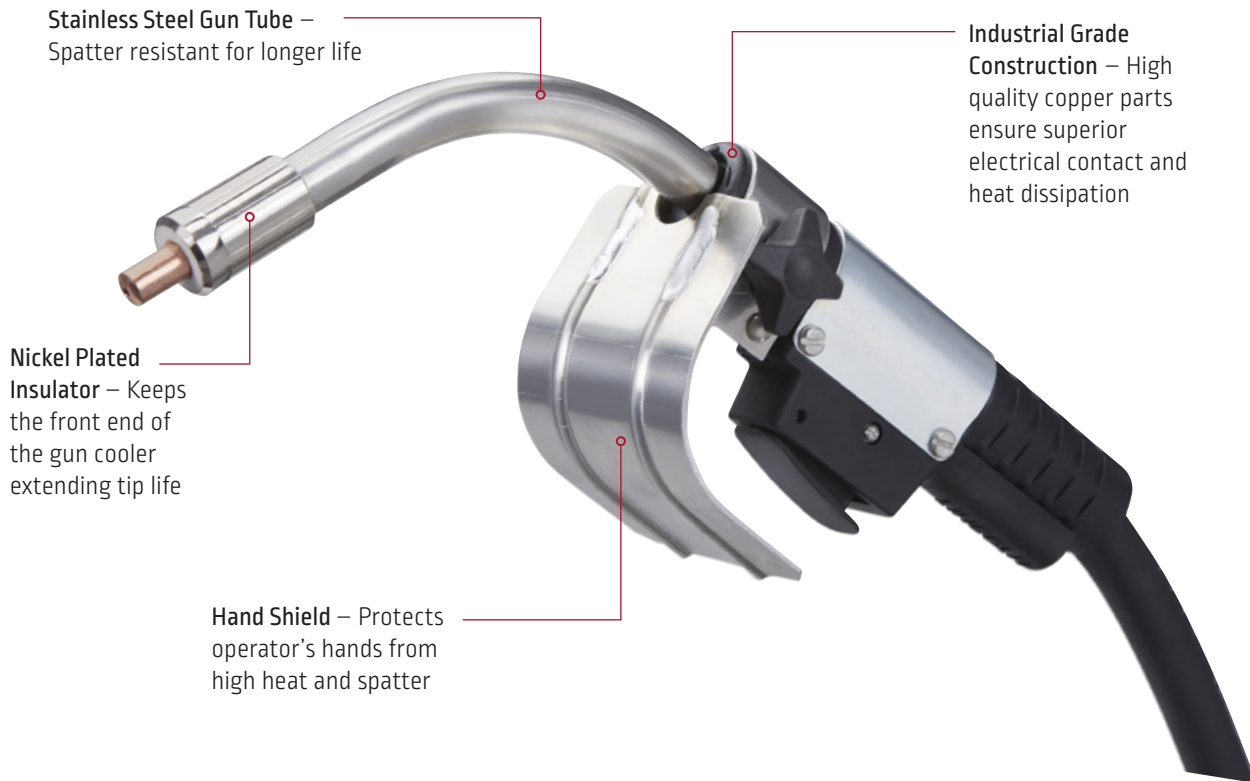

### K126 PRO INNERSHIELD GUNS

Product Name	Product Number	Gooseneck Angle	Gun Connector Power Pin	Amperage Rating 60% Duty Cycle	Wire Diameter Range in. (mm)	Cable Length ft. (m)
K126 PRO	K126-10	62°	Lincoln Electric K613-6	350	0.035 - 0.120 (0.9 - 3.0)	10 (3.0)
K126 PRO	K126-11	62°	Lincoln Electric K613-6	350	0.035 - 0.120 (0.9 - 3.0)	15 (4.5)
K126 PRO	K126-12	62°	Tweco #4 K466-10	350	0.035 - 0.120 (0.9 - 3.0)	15 (4.5)
K126 PRO	K126-13	30°	Lincoln Electric K613-6	350	0.035 - 0.120 (0.9 - 3.0)	15 (4.5)

For more information see the [K126 PRO Spec Guide: E12.111](#)

# Magnum PRO Spool Guns





# Magnum PRO 100SG Spool Guns

## PRECISE FEEDING PERFORMANCE

The Magnum PRO 100SG spool gun is a low cost solution for reliable and precise wire feeding performance for soft aluminum wire. Its durable carrying case and easy to set up connection allows for aluminum welding on the go.

### Key Features



**Sturdy Carrying Case** – Protects the gun during transportation

**Lightweight** – Gun weighs only 3.5 lbs.

**Quick Connection** – Directly connects to multiple welding machines



### MAGNUM PRO BARREL GUNS

Product Name	Product Number	Connection Type	Wire Diameter Range in (mm)	Cable Length ft (m)	Equipment Compatibility
Magnum PRO 100SG Spool Gun	K3269-1	4 Pin	0.030 - 0.035 (0.8-0.9)	10 (3.0)	POWER MIG 216, POWER MIG 210 MP, POWER MIG 140C, POWER MIG 180C, POWER MIG 180 Dual, SP-140T, SP-180T
	K4360-1	8 Pin			POEWR MIG 140MP, MIG-Pak 140, LE31MP

For more information see the [100SG Spool Gun Spec Guide: E12.20](#)

# Magnum PRO 250LX Spool Guns

## VERSATILITY WITHOUT HASSLE

The Magnum PRO 250LX spool gun partners longer-lasting Magnum PRO contact tips with a durable spool gun design, making it the most versatile accessory for the POWER MIG® family.



### PRODUCT SPECIFICATIONS

Product Name	Product Number	Cable Length ft (m)	Wire Size Range in (mm)	Rated Output Current/ Duty Cycle	Net Wt. lbs (kg)
Magnum PRO 250LX	K3570-2	25 ft. (7.6)	.030-3/64 in. (0.8-1.2) Aluminum .025-.035 in. (0.6-0.9) Steel	280A @ 60% Duty Cycle (Mixed Gas) 200A @ 100% Duty Cycle (Mixed Gas)	3 (1.36)

For more information see the 250LX Series Spool Gun Spec Guide: E12.29

# Magnum PRO 250LX GT Spool Guns

## PRODUCTIVITY WITHOUT HASSLE

With longer-lasting Magnum PRO Expendables and direct connect functionality, the Magnum PRO 250LX GT spool gun results in less downtime and hassle-free setup. The Magnum PRO 250LX GT spool gun connects easily to the Ranger 330 MPX without the need for additional adapters or control boxes. Competitive spool gun setups are complex and expensive, with control boxes adding up to \$1,500 in extra costs. With only 3 easy steps, the Magnum PRO 250LX GT adds functionality without adding costs or hassle.



### PRODUCT SPECIFICATIONS

Product Name	Product Number	Cable Length ft (m)	Wire Size Range in (mm)	Rated Output Current/ Duty Cycle	Net Wt. lbs (kg)
Magnum PRO 250LX GT	K3569-2	25 ft. (7.6)	.030 - 3/64 in. (0.8 – 1.2) Aluminum .025 - .035 in. (0.6 – 0.9) Steel	280A @ 60% Duty Cycle (Mixed Gas) 200A @ 100% Duty Cycle (Mixed Gas)	3 (1.36)

For more information see the 250LX GT Series Spool Gun Spec Guide: E12.28

# Push-Pull Guns

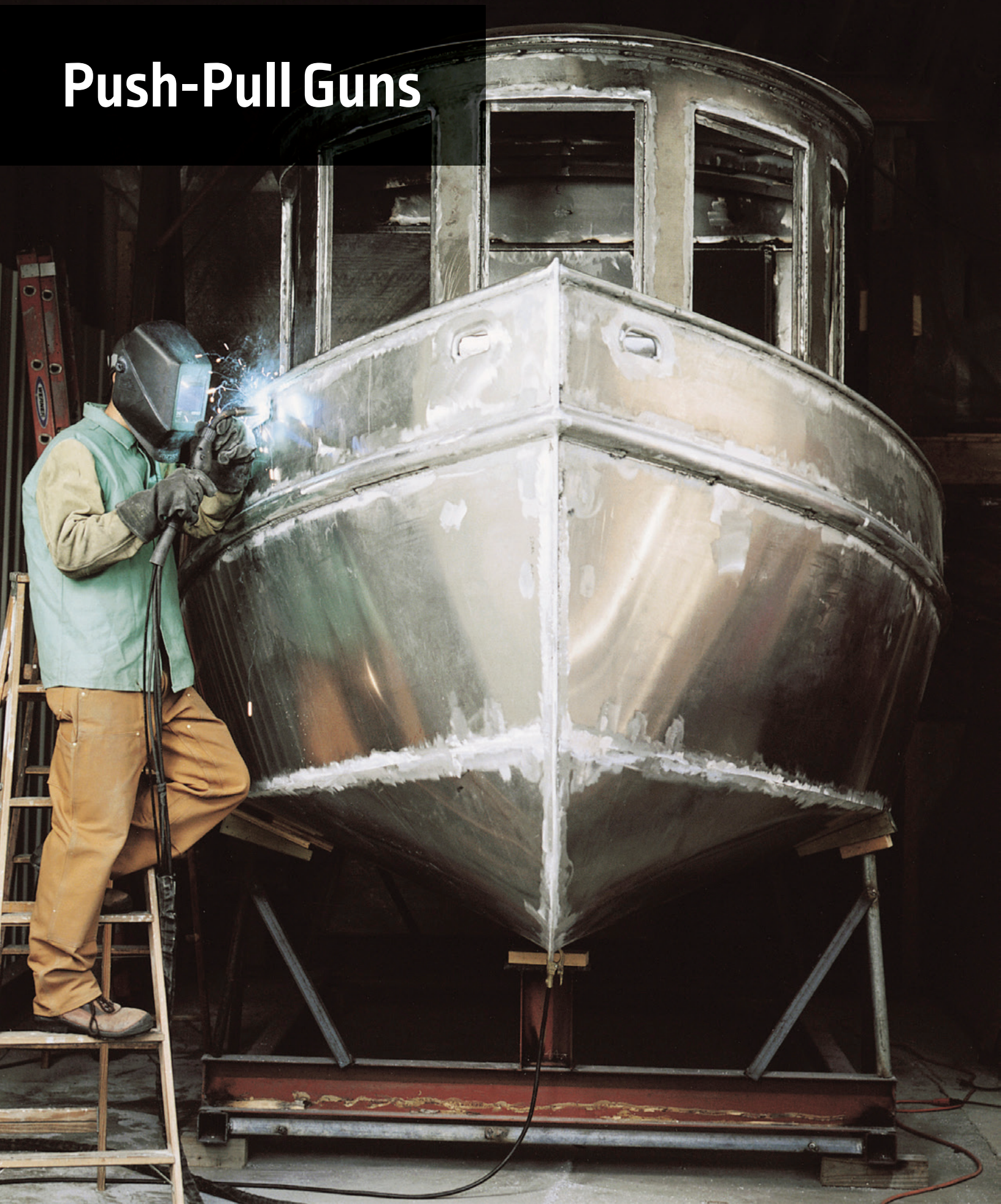

# Push vs. Push-Pull Guns

When deciding on whether to select a Push-Pull or Push Only welding gun, there are a few key questions to consider, helping make the determination simple. The question of system set-up cost can be a factor for deciding between the two feeding styles, but the use of a push only gun falls into certain procedural constraints, sometimes making the decision for you.

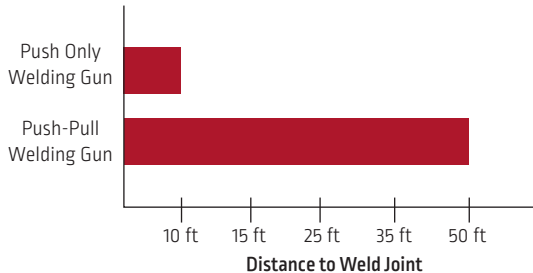

**1. How far away from the feeder will you be welding?**  
 Aluminum can be difficult to feed consistently over long distances if not set-up properly. In order to counteract the highly flexible wire, the use of a push-pull welding gun can extend the distance in which the wire is fed.

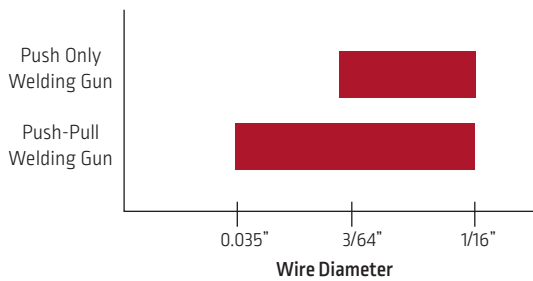

**2. What diameter of aluminum wire will you be running?**  
 If distance to the weld joint is not the main concern, the diameter of aluminum wire will help determine whether a push only gun is the right solution for your application. The smaller the diameter of the wire, the more challenging it is to feed the aluminum consistently. For this reason, we recommend push only welding set-ups should only be used for aluminum with that is between 3/64-1/16 in.



Product Name	Magnum PRO 300 AL Push Gun	Magnum PRO AL FC Push-Pull Gun	Magnum PRO Pistol Grip Push-Pull Gun
Part Numbers	K4700-1-10-116A, K4700-1-6-116A, K4700-1-FM-116A	K4795-X, K4796-X, K4797-X, K4798-X	K3478-X, K3479-X
Argon Duty Cycle	80%	60%	60%
Amperage Range	225 A	225-450 A	220-320 A
Cooling Type	Air	Air and Water	Air and Water
Wire Diameter Range	3/64 - 1/16 in (1.2 - 1.6 mm)	0.035 - 1/16 in (0.9 - 1.6 mm)	0.035 - 1/16 in (0.9 - 1.6 mm)
Cable Lengths	10ft	15ft 25ft 35ft 50ft	15ft 25ft 35ft
Handle Style	Curve	Gooseneck	Pistol Grip
Magnum PRO Expendables	✓	✓	✓

# Magnum PRO 300 AL Push Gun

## COST EFFECTIVE ALUMINUM WELDING

The Magnum® PRO AL Push Gun is a cost effective solution for welding 3/64" -1/16" aluminum wire over distances up to 10 ft. This welding gun solution was designed with the soft wire in mind, and includes the proper expendables to ensure premium performance for the recommended applications.

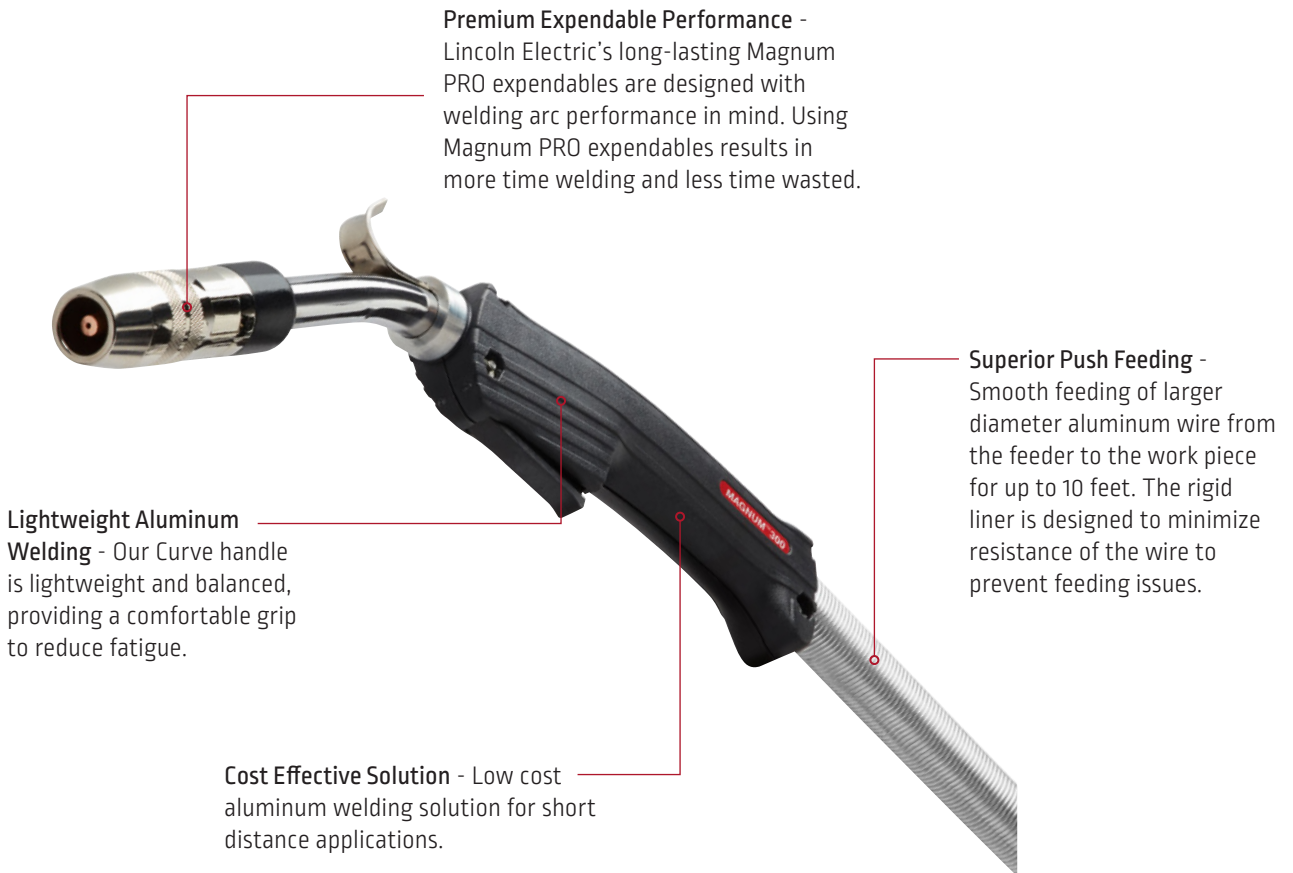

**Premium Expendable Performance** - Lincoln Electric's long-lasting Magnum PRO expendables are designed with welding arc performance in mind. Using Magnum PRO expendables results in more time welding and less time wasted.

**Lightweight Aluminum Welding** - Our Curve handle is lightweight and balanced, providing a comfortable grip to reduce fatigue.

**Superior Push Feeding** - Smooth feeding of larger diameter aluminum wire from the feeder to the work piece for up to 10 feet. The rigid liner is designed to minimize resistance of the wire to prevent feeding issues.

**Cost Effective Solution** - Low cost aluminum welding solution for short distance applications.

### PRODUCT SPECIFICATIONS

Product Name	Product Number	Rated Output Current/ Duty Cycle	Wire Diameter Range in. (mm)	Cable Length ft (m)	Backend Connector
Magnum PRO 300 AL Push Gun	K4700-1-FM-116A	225A @ 80% Duty Cycle (100% Argon)	3/64 – 1/16 (1.2 – 1.6)	10 (3.0)	Fast Mate
	K4700-1-6-116A		3/64 – 1/16 (1.2 – 1.6)		K466-6
	K4700-1-10-116A		3/64 – 1/16 (1.2 – 1.6)		K466-10

For more information see the 300 AL Series Push Gun Spec Guide: E12.34

# Magnum PRO AL FC Push-Pull Welding Guns

## CONSISTENT, RELIABLE ALUMINUM FEEDING

The new, improved Magnum PRO AL Fixed Conduit Push-Pull Guns feature a new rigid liner which provides a smooth, premium aluminum welding solution. The enhanced feeding capabilities will reduce downtime and increase arc on time

**Magnum PRO Expendables** - Long-lasting expendables designed to help maximize weld time and reduce downtime

**New Fixed Conduit Liner** - Fixed, rigid all-in-one liner helps improve soft aluminum wire feeding

**Quick WFS Adjustment** - A dial located at the bottom of the gun handle provides a convenient way of changing WFS at the arc

**Enhanced Internal Design** - Modifications to the strain relief and trigger help improve durability and performance



### PRODUCT SPECIFICATIONS

Product Name	Product Number 12-Pin	Amperage Rating 100% Argon Gas	Wire Diameter Range in (mm)	Cable Length ft (m)
Magnum PRO AL FC 225 Air, Rear Trigger	K4795-1	225A @ 60% Duty Cycle	0.035 - 1/16 (0.9 - 1.6) aluminum and cored wire	15 (4.5)
	K4795-2			25 (7.6)
	K4795-3			35 (10.6)
	K4795-4			50 (15.2)
Magnum PRO AL FC 225 Air, Front Trigger	K4797-1	225A @ 60% Duty Cycle	0.035 - 1/16 (0.9 - 1.6) aluminum and cored wire	15 (4.5)
	K4797-2			25 (7.6)
	K4797-3			35 (10.6)
	K4797-4			50 (15.2)
Magnum PRO AL FC 450 Water, Rear Trigger	K4796-1	450A @ 60% Duty Cycle	0.035 - 1/16 (0.9 - 1.6) aluminum and cored wire	15 (4.5)
	K4796-2			25 (7.6)
	K4796-3			35 (10.6)
	K4796-4			50 (15.2)
Magnum PRO AL FC 450 Water, Front Trigger	K4798-1	450A @ 60% Duty Cycle	0.035 - 1/16 (0.9 - 1.6) aluminum and cored wire	15 (4.5)
	K4798-2			25 (7.6)
	K4798-3			35 (10.6)
	K4798-4			50 (15.2)

For more information see the AL FC Series Push-Pull Gun Spec Guide: E12.14

# Magnum PRO Pistol Grip Push-Pull Welding Guns

The new Magnum PRO AL Pistol Grip models are designed to optimize a push-pull welding operation for aluminum by integrating features that will reduce downtime.

**Magnum PRO Expendables** - Long-lasting expendables designed to help maximize weld time and reduce downtime



**Quick-Change Liner** - Simply remove the liner nut to easily access the liner.

**Superior push-pull wire feeding technology** - Reduces friction in the wire feed path, resulting in smooth feeding and minimizing damage to the wire.

**Recessed adjustment dial** - Conveniently located at the rear of the handle to prevent a change while welding.

## PRODUCT SPECIFICATIONS

Product Name	Product Number 12-Pin	Amperage Rating 100% Argon Gas	Wire Diameter Range in (mm)	Cable Length ft (m)
Magnum® PRO AL Pistol Air	K3478-1	220A @ 60% Duty Cycle	0.035 - 1/16 (0.9 - 1.6) Aluminum Wire	15 (4.5)
	K3478-2			25 (7.6)
	K3478-3			35 (10.7)
Magnum® Pro AL Pistol Water	K3479-1	320A @ 60% Duty Cycle	0.035 - 0.045 (0.9 - 1.2) Steel Wire	15 (4.5)
	K3479-2			25 (7.6)

For more information see the [Pistol Grip Push-Pull Gun Spec Guide: E12.17](#)



# Magnum PRO Expendables



# Magnum PRO Expendables

Lincoln Electric's long-lasting Magnum PRO expendables have patented features that are designed with both performance and productivity in mind. The premium performance of the expendables can extend their service life, reducing downtime and overall costs. Using Magnum PRO expendables on your Magnum PRO Curve HDE results in more time welding and less time wasted, leading to overall savings.

## Key Features

- **Premium Expendable Performance** - Lincoln Electric's long-lasting Magnum PRO expendables are designed with welding arc performance in mind. Using Magnum PRO expendables results in more time welding and less time wasted
- **Complete Product Portfolio** – Lincoln Electric offers expendables for any application. Whether welding in a tight joint or at a high amperage, there is a Magnum® PRO Expendable configuration for you.

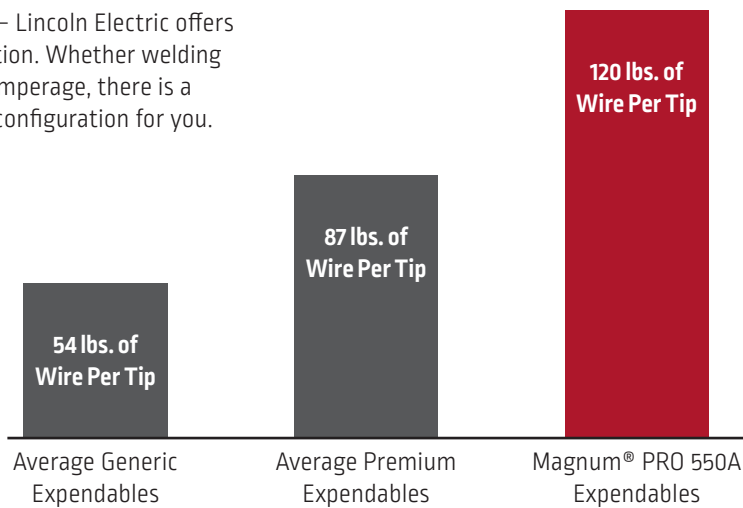

Lasts Up To  
**124% Longer**

Results in Up to  
**\$415 of Savings**  
per Gun Annually by Switching to Magnum PRO

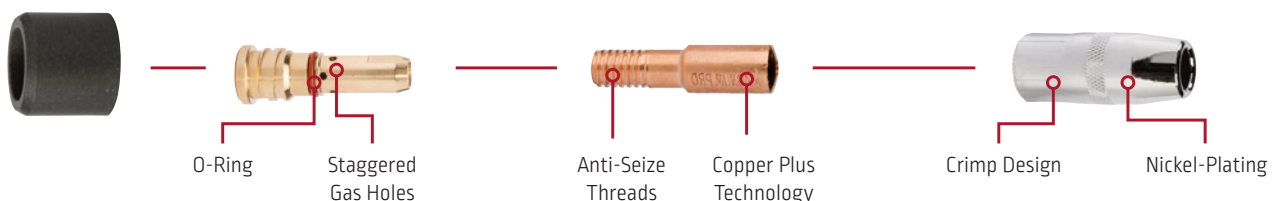

\*Note: Results can vary from set-up to set-up.

# Magnum PRO Copper Plus Contact Tips



## Key Features

- **Copper Plus®** - Larger diameter allows for increased copper content in each contact tip. The added copper disperses heat and keeps the tip cooler, longer.
- **Anti-Seize™ Threading** – The thread on Magnum® PRO contact tips are designed to prevent the tip from melting, fusing, and seizing in the diffuser.
- **Complete Product Portfolio** – Magnum® PRO Copper Plus® contact tips come in all shapes and sizes. There are options for any application and configuration.

## How To Choose The Proper Contact Tip:

1. Choose your amperage class
2. Choose contact tip type (standard, tapered or robotic)
3. Choose your wire type/diameter

## WHAT'S THE DIFFERENCE

Standard	Tapered	Robotic
		
Best for multi-purpose welding Lasts longer than tapered tips	Best for welding in tight joints Use with tapered, 3/8 in. or 1/2 in. ID nozzles	Best for heavy duty or robotic applications Made from Chrome Zirconium Copper alloy that minimizes annealing and wearing

## PRODUCT SPECIFICATIONS

Wire Size	350A, Standard Tip		350A, Tapered Tip		550A, Standard Tip		550A, Tapered Tip		550A, Robotic Tip
	Steel	Aluminum	Steel	Aluminum	Steel	Aluminum	Steel	Aluminum	Steel
.025"	KP2744-025	-	KP2744-025T	-	-	-	-	-	-
.030"	KP2744-030	KP2744-030A	KP2744-030T	-	-	KP2745-030A	-	-	-
.035"	KP2744-035	KP2744-035A	KP2744-035T	KP2744-035AT	KP2745-035	KP2745-035A	KP2745-035T	KP2745-035AT	KP2745-035R
.040"	KP2744-040	-	KP2744-040T	-	KP2745-040	-	KP2745-040T	-	KP2745-040R
.045"	KP2744-045	-	KP2744-045T	-	KP2745-045	-	KP2745-045T	-	KP2745-045R
3/64"	-	KP2744-364A	-	KP2744-364AT	-	KP2745-364A	-	KP2745-364AT	-
.052"	KP2744-052	-	KP2744-052T	-	KP2745-052	-	KP2745-052T	-	KP2745-052R
1/16"	KP2744-116	KP2744-116A	KP2744-116T	KP2744-116AT	KP2745-116	KP2745-116A	KP2745-116T	KP2745-116AT	KP2745-116R
.068"-.072"	-	-	-	-	KP2745-072	-	-	-	KP2745-072R
5/64"	KP2744-564	-	KP2744-564T	-	KP2745-564	-	KP2745-564T	-	KP2745-564R
3/32"	-	-	-	-	KP2745-332	-	-	-	KP2745-332R
7/64"	-	-	-	-	KP2745-764	-	-	-	KP2745-764R
1/8"	-	-	-	-	KP2745-18	-	-	-	-

\*For Bulk Packaging, place a "-B100" behind any part number.

# Magnum PRO Nozzles

## Key Features

- **Chrome Plated** – Prevents spatter from adhering to the nozzle so it can be easily brushed off with a gloved hand
- **Coarse Threads** – Ensures the threads do not seize onto the gas diffuser making it easy to remove the nozzle

## How To Choose The Proper Nozzle:

1. Choose your amperage class
2. Choose style based on application
3. Choose nozzle ID based on gas flow needed
4. Choose between Thread-On and Slip-On

## WHAT'S THE DIFFERENCE

Recess	Flush	Stickout	Bottleneck	Extended Reach	Narrow Gap
					
Used in most spray and pulse applications	Used in short circuit STT applications	Used in short circuit and STT applications, or in particularly tight joints for better access	Improved visibility and access to tighter joints	Better access to difficult to reach joints Added 1.5 inches over standard nozzle length	Used for access to tight joints that are hard to reach

## PRODUCT SPECIFICATIONS

Amperage Rating	Cooling	Thread Type	Nozzle Type in (mm)	3/8 in ID, Standard	1/2 in ID, Standard	1/2 in ID, Extended Reach	1/2 in ID, Narrow Gap	1/2 in ID, Bottleneck	5/8 in ID, Standard	5/8 in ID, Bottleneck	3/4 in ID, Standard
350A	Air	Thread-On	1/8 (3.2) Recess	KP2742-1-38R	KP2742-1-50R	KP3359-1-50R	KP3617-1-50R	KP3160-1-50R	KP2742-1-62R	-	-
			Flush	KP2742-1-38F	KP2742-1-50F	KP3359-1-50F	KP3617-1-50F	KP3160-1-50F	KP2742-1-62F	-	-
			1/8 (3.2) Stickout	KP2742-1-38S	KP2742-1-50S	KP3359-1-50S	KP3617-1-50S	KP3160-1-50S	KP2742-1-62S	-	-
		Slip-On	1/8 (3.2) Recess	-	KP2742-2-50R	-	-	-	KP2742-2-62R	-	-
			Flush	-	KP2742-2-50F	-	-	-	KP2742-2-62F	-	-
			1/8 (3.2) Stickout	-	KP2742-2-50S	-	-	-	KP2742-2-62S	-	-
550A	Air	Thread-On	1/8 (3.2) Recess	KP2743-1-38R	KP2743-1-50R	-	-	-	KP2743-1-62R	KP3161-1-62R	KP2743-1-75R
			Flush	KP2743-1-38F	KP2743-1-50F	-	-	-	KP2743-1-62F	KP3161-1-62F	KP2743-1-75F
			1/8 (3.2) Stickout	KP2743-1-38S	KP2743-1-50S	-	-	-	KP2743-1-62S	KP3161-1-62S	KP2743-1-75S
		Slip-On	1/8 (3.2) Recess	-	KP5130-2-50R	-	-	-	KP5130-2-62R	-	KP5130-2-75R
			Flush	-	KP5130-2-50F	-	-	-	KP5130-2-62F	-	KP5130-2-75F
			1/8 (3.2) Stickout	-	KP5130-2-50S	-	-	-	KP5130-2-62S	-	KP5130-2-75S
500A	Water	Thread-On	1/8 (3.2) Recess	-	KP4523-1-50R	-	-	-	KP4523-1-62R	-	KP4523-1-75R
			Flush	-	KP4523-1-50F	-	-	-	KP4523-1-62F	-	KP4523-1-75F
			1/8 (3.2) Stickout	-	KP4523-1-50S	-	-	-	KP4523-1-62S	-	KP4523-1-75S

\*For Bulk Packaging, add "-B25" to the end of any part number.

# Magnum PRO Diffusers

## Key Features

- **Coarse Threads** – Ensures the threads of the nozzle do not seize onto the gas diffuser making it easy to remove
- **Front End Versatility** – Various diffuser offerings for most applications

## How To Choose The Proper Gas Diffuser:

1. Choose your amperage class
2. Choose your diffuser length
3. Choose diffuser material
4. Thread-On or Slip-On?

## WHAT'S THE DIFFERENCE

Thread-On	Slip-On	Copper	Extended Length
			
Threads provide a secure connection between the nozzle and the diffuser	Slip-on design allows for quick and easy removal of the gas nozzle from the diffuser	Copper can withstand higher heat input than brass allowing for extended life performance. The gas holes are drilled at an angle to provide a more direct flow pattern for the shield gas.	Adds an additional 1.5" to the reach on the front of your welding gun. Must be paired with the Extended Reach or Narrow Gap gas nozzles.

## PRODUCT SPECIFICATIONS

Amperage Rating	Cooling	Thread Type	Brass	Brass for Aluminum	Copper	Extended Reach	1/4 in Recessed
100A	Air	Thread-On	KP3076-1	-	-	-	-
350A		Thread-On	KP2746-1	-	-	KP3360-1	-
		Slip-On	KP2746-2	-	-	-	-
550A	Air	Thread-On	KP2747-1	KP2747-1A	KP4766-1	KP4781-1	KP3155-1
		Slip-On	KP2747-2	-	KP4766-2	-	-
500A	Water	Thread-On	KP4380-1	-	-	-	-

\*For Bulk Packaging, place a "-B25" behind any part number.

\*\*For replacement o-rings order the following part numbers: KP3982-1 for 350A Diffusers or KP3982-2 for 550A Diffusers

# Magnum PRO Semi-Automatic Gun Tubes

Gun Tubes come in various shapes and sizes and can further customize your welding gun configuration. Whether you need a short gun tube for a confined space or an extra long configuration to weld on a hard to reach joint, there is a Magnum PRO gun tube configuration for every application!

When selecting the right gun tube, there are a couple questions to run through in order to pick the correct part number.

1. What welding gun family have you selected?
2. What length gun tube do you need?
3. What angle do you need the bend of your gun tube to be?

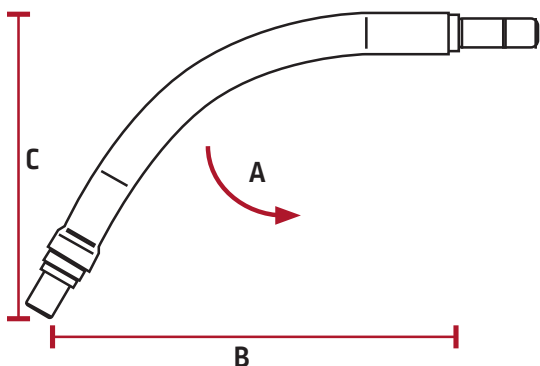

## PRODUCT SPECIFICATIONS

Welding Gun Family	Amperage	Cooling	Part Number	Angle (A) Degrees	Length (B) in.	Height (C) in.	
Magnum PRO Barrel	250	Air	KP2866-45	45	4.9	2.2	
			KP2866-60	60	4.5	2.5	
			KP2867-45	45	6	2.8	
	450		KP2867-60	60	5.6	3.1	
			KP2868-180	180	7.7	0.0	
			KP2868-45	45	6.7	2.8	
			KP2868-60	60	6.3	3.2	
			KP2868-82	82	6.1	4.6	
			550	KP2869-180	180	9.7	0.0
	KP2869-45			45	8.3	4.1	
	KP2869-60			60	7.7	4.6	
				11.7	4.6		
	KP2869-60SN				6.2	3.2	
	Magnum PRO Curve		200	KP3200-2	Flexible	8.1	Flexible
				KP2924-30	30	4.6	1.9
KP2924-45		45		4.0	1.8		
300		KP2924-60	60	3.5	2.4		
		KP2925-30	30	4.6	1.9		
		KP2925-45	45	4.6	2.1		
		KP2925-60	60	4.0	3.1		
			6.6	2.1			
400		KP2926-60	60	6.0	3.1		
		KP2926-60L	8.9	8.7			
			4.5	4.5			
		KP2926-82	82	4.5	4.5		
		KP3200-1	Flexible	9.2	Flexible		
Magnum PRO 100L		100	KP3082-60	60	3.6	1.6	
Magnum PRO 175L		175	KP4087-1	60	5.0	2.8	
Magnum PRO 250L		250	KP3078-45	45	3.7	2.3	
			KP3078-60	60	3.1	2.9	
Magnum PRO HDE		250	KP4693-45	45	4.2	2.0	
			KP4693-60	60	3.2	2.5	
			KP4694-45	45	4.9	2.6	
		350	KP4694-60	60	4.4	2.9	
			KP4695-45	45	6.4	2.8	
			KP4695-60	60	5.9	3.1	
				7.2	4.0		
			550	KP4696-45	45	6.4	2.8
	KP4696-45SN				6.4	2.8	
	KP4696-60	60		6.5	4.5		
	550	KP4696-60SN	5.9	3.0			
			3.0	0.0			
		KP5147-1*	180	3.0	0.0		
		KP5148-1*		9.0	0.0		
	Magnum PRO 500 Water-Cooled	500	Water	KP4526-45	45	5.3	2.3
KP4526-45L3					8.3	2.3	
KP4526-60			60	5.3	3.3		
			8.3	3.3			
Magnum PRO 400 Water-Cooled	400	Water	KP4527-45	45	7.1	2.6	
			KP4527-60	60	6.6	3.2	

\*Used with KP5146-1

# Magnum PRO Aluminum Solution Gun Tubes

The same method and questions can be used when selecting a gun tube for your Aluminum welding gun solutions!

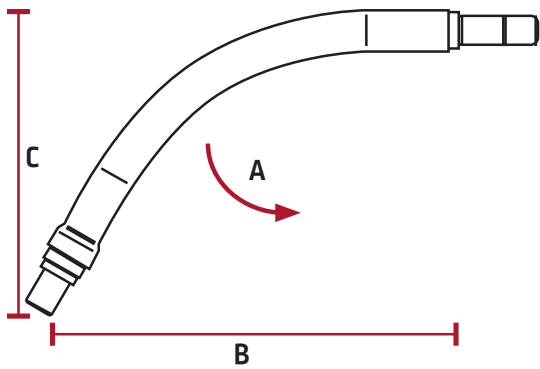

## PRODUCT SPECIFICATIONS

Welding Gun Family	Amperage	Cooling	Part Number	Angle (A) Degrees	Length (B) in.	Height (C) in.
Magnum PRO 100SG	100	Air	KP3325-1	180	2.0	0.0
Magnum PRO 250LX GT/	250		KP3682-180	180	3.7	0.0
			KP3682-45	45	4.4	1.6
Magnum PRO 250LX			KP3682-60	60	3.9	2.3
Magnum PRO AL FC Push-Pull	450	Air/Water	KP3380-180	180	4.5	0.0
			KP3380-45	45	4.3	2.1
			KP3380-60	60	2.8	3.0
	Water	KP3381-180	180	3.8	0.0	
		KP3381-45	45	3.9	2.5	
		KP3381-60	60	3.7	3.1	
	Air/Water	KP3988-45	45	4.6	2.6	
		KP3988-60	60	3.9	2.9	
		Magnum PRO AL Pistol Grip Push-Pull	220	Air	KP3541-180	180
KP3541-45	45				4.2	2.9
KP3541-60	60				4.0	3.0
320	Water	KP3542-180	180	2.6	0.0	
		KP3542-45	45	5.3	3.0	
		KP3542-60	60	4.9	3.1	

## Gun Tube Angles



45 Degree

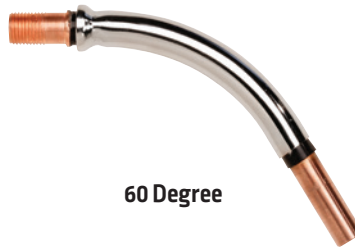

60 Degree



82 Degree



180 Degree



Flexible

# Magnum PRO Cable Liners

Cable Liners are selected by matching the welding gun, wire diameter, and backend connector used on the welding gun configuration you have selected. Use the following questions to select the proper cable liner for your configuration.

1. What backend connector part number is used on your gun?
2. What is the diameter or your welding wire?
3. How long is your welding gun cable?



## PRODUCT SPECIFICATIONS

Amperage Class	Wire Diameter	K466 Series Connectors		K613 Series Connectors	
		Cable Length		Cable Length	
		10 - 15 ft	20 - 25 ft	10 - 15 ft	20 - 25 ft
100 - 175A	0.025 - 0.035	KP35-40-15	-	-	-
	0.035 - 0.045	KP45-40-15	-	-	-
200 - 250A	0.025 - 0.030	KP42-25-15	KP42-25-25	-	-
	0.030 - 0.035	KP42-3035-15	KP42-3035-25	-	-
	0.035 - 0.045	KP42-4045-15	KP42-4045-25	-	-
300 - 550A	0.035 - 0.045	KP44-3545-15	KP44-3545-25	KP45-3545-15	KP45-3545-25
	0.052 - 1/16	KP44-116-15	KP44-116-25	KP45-116-15	KP45-116-25
	1/16 - 5/64	KP44-564-15	KP44-564-25	-	-
	5/64 - 3/32	KP44-332-15	KP44-332-25	KP45H-332-15	KP45H-332-25
	7/64 - 1/8	-	-	KP45-18-15	KP45-18-25

# Magnum PRO Insulators

When selecting the correct insulator for your set up, the main question is which amperage class do your contact tip, nozzle and diffuser fall under?

With Magnum PRO Expendables, you must match the amperage class of the whole front end set-up.

Example: A 350A Insulator must be used with a 350A Nozzle, Diffuser, and Contact Tip.



KP2773-2

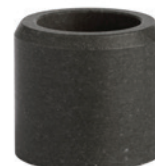

KP2773-1

## PRODUCT SPECIFICATIONS

Amperage Rating	Per Package	Part Number
350	1	KP2773-2
	25	KP2773-2-B25
550	1	KP2773-1
	25	KP2773-1-B25







#### CUSTOMER ASSISTANCE POLICY

The business of Lincoln Electric is manufacturing and selling high quality welding equipment, automated welding systems, consumables, and cutting equipment. Our challenge is to meet the needs of our customers, who are experts in their fields, and to exceed their expectations. On occasion, purchasers may ask Lincoln Electric for information or technical information about their use of our products. Our employees respond to inquiries to the best of their ability based on information and specifications provided to them by the customers and the knowledge they may have concerning the application. Our employees, however, are not in a position to verify the information provided or to evaluate the engineering requirements for the particular weldment, or to provide engineering advice in relation to a specific situation. Accordingly, Lincoln Electric does not warrant or guarantee or assume any liability with respect to such information or communications. Moreover, the provision of such information or technical information does not create, expand, or alter any warranty on our products. Any express or implied warranty that might arise from the information or technical information, including any implied warranty of merchantability or any warranty of fitness for any customers' particular purpose or any other equivalent or similar warranty is specifically disclaimed.

Lincoln Electric is a responsive manufacturer, but the definition of specifications, and the selection and use of specific products sold by Lincoln Electric is solely within the control of, and remains the sole responsibility of the customer. Many variables beyond the control of Lincoln Electric affect the results obtained in applying these types of fabrication methods and service requirements.

