



LINCOLN
ELECTRIC

LINCOLN
ELECTRIC

WELDING CONSUMABLES

CATALOG | C1.10

LINCOLN
ELECTRIC



RED MAX[®] Stainless Steel MIG Welding Wire

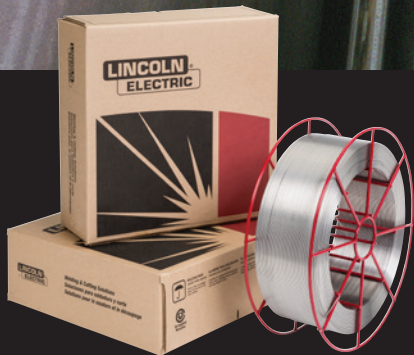

Simplify the challenges of welding stainless with RED MAX[®] stainless MIG wires. Consistent wire feeding and arc placement deliver less contact tip wear than leading competitive wires.

Less downtime; increased productivity. That adds up to improved production performance.

Learn more at lincolnelectric.com/RedMaxWJ



TABLE OF CONTENTS

STICK ELECTRODES	A (1-31)
MIG & TIG	B (1-41)
METAL-CORED	C (1-17)
FLUX-CORED	D (1-103)
SUBMERGED ARC	E (1-45)
STAINLESS	F (1-139)
NICKEL	G (1-27)
HARDFACING	H (1-69)
CHROME-MOLY	I (1-35)
ALUMINUM & CAST IRON	J (1-17)
PIPELINER®	K (1-27)
POWER GENERATION & NUCLEAR.....	L (1-41)
PACKAGING	M (1-17)
APPENDIX	N (1-25)

Welding Consumables1-9
 Introduction10
 Q Lot Certifications11
 En Certifications.....12
 Catalog User Guide.....13

STICK

Stick (SMAW) Electrode

Mild Steel, Low Hydrogen

Excalibur® 7018 MR® A-1
 Ironarc™ 7018 MR® A-2
 Excalibur® 7018 XMR™ A-3
 Excalibur® 7018-1 MR® A-4
 IronArc™ 7018-1 MR® A-5
 Excalibur® 7028 A-6
 Lincoln® 7018 AC A-7
 Excalibur® 7018-A1 MR® A-8
 Excalibur® 8018-B2 MR® A-9
 Excalibur® 8018-C1 MR® A-10
 Excalibur® 8018-C3 MR® A-11
 Excalibur® 9018M MR® A-12
 Excalibur® 10018-D2 MR® A-13
 Excalibur® 11018M MR® A-14

Mild Steel, Cellulosic

Fleetweld® 5P+® A-15
 Fleetweld® 5P® A-16
 Fleetweld® 35 A-17
 Fleetweld® 180 A-18
 Murex® 6011C A-19

Mild Steel, Rutile

Fleetweld® 22 A-20
 Fleetweld® 37 A-21
 Fleetweld® 47 A-22
 Murex® 6013D A-23
 Murex® 7014 A-24

Mild Steel, High Deposition

Jetweld 1 A-25
 Murex® 7024 A-26

Low Alloy, Cellulosic, Pipe

Shield-Arc® HYP+ A-27
 Shield-Arc® 85 A-28
 Shield-Arc® 70+ A-29
 Shield-Arc® 90 A-30

MIG & TIG

MIG (GMAW) Wire

Mild Steel, Non-Copper Coated

SuperGlide® S3 B-1
 SuperGlide® S6 B-3

Mild Steel, Copper Coated

SuperArc® L-50° B-5
 SuperArc® L-52° B-7
 SuperArc® L-56° B-9
 SuperArc® L-59° B-11
 SUPERARC® XLS B-13
 SuperArc® G4Si1 B-15
 Murematic® S3 B-17
 Murematic® S4+ B-18
 Murematic® S6 B-19
 Lincoln S6 B20

Low Alloy Steel

1CRMO B-22
 2CRMO B-23
 Techalloy® 4130 B-24

Low Alloy, Copper Coated

SuperArc® LA-75™ B-25
 SuperArc® LA-90™ B-27
 SuperArc® LA-100™ B-29
 SuperArc® AK-10° B-31

Copper Alloys

SuperGlaze™ SiBR B-33

TIG (GTAW) Cut Length

Low Alloy Steel

5CRMO B-34
 Lincoln® ER80S-D2 B-35
 Lincoln® ER80S-Ni1 B-36
 Lincoln® LA-84 B-37
 Techalloy® 4130 B-38
 Lincoln® AK-10° B-39

Mild Steel, Copper Coated

Lincoln® ER70S-2 B-40
 Lincoln® ER70S-6 B-41

METAL-CORED

GMAW-C Wire

Mild Steel

Metalshield® MC®-70 XLS™	C-1
Metalshield® MC-6°	C-3
Metalshield® MC-710XL°	C-5
Metalshield® Z°	C-7

Low Alloy

Metalshield® MC®-80 XLS™	C-9
Metalshield® MC®-90	C-11
Metalshield® MC®-110	C-13
Metalshield® MC®-120	C-15

FLUX-CORED

Self-Shielded (FCAW-S) Wire

Mild Steel, Flat and Horizontal

Innershield® NR®-5	D-1
Innershield® NR®-131	D-2
Innershield® NR®-305	D-3
Innershield® NR®-311	D-4
Innershield® NS-3M	D-5

Low Alloy, Flat and Horizontal

Innershield® NR®-311 Ni	D-6
-------------------------	-----

Mild Steel, All Position

Innershield® NR®-152	D-7
Innershield® NR®-203-MP	D-8
Innershield® NR®-211-MP	D-9
Innershield® NR®-232	D-11
Innershield® NR®-232-H	D-13
Innershield® NR®-233	D-15

Low Alloy, All Position

Innershield® NR®-203 Nickel (1%)	D-17
Innershield® NR®-207	D-18
Innershield® NR®-208-H	D-19
Innershield® NR®-212	D-20
Innershield® NR®-440Ni2	D-22
Innershield® NR®-555	D-24

Gas-Shielded (FCAW-G) Wire

Mild Steel, All Position

UltraCore® 360™ C71	D-26
UltraCore® 360™ M71	D-28

UltraCore® 71A75 Dual	D-30
UltraCore® 71A85	D-32
UltraCore® 712C	D-34
UltraCore® 712C-H Plus	D-36
UltraCore® 712A80	D-38
UltraCore® 712A80-H Plus	D-40
UltraCore® HD-C	D-42
UltraCore® HD-M	D-44
UltraCore® HD-12C	D-46
UltraCore® HD-12M	D-48
Ultracore® HD Marine	D-50
Outershield® 71M	D-52
Outershield® 71 Elite	D-54
Outershield® 71 Elite Supreme	D-56

Mild Steel, Flat and Horizontal

UltraCore® 70C	D-58
UltraCore® 75C	D-60
UltraCore® XP70	D-62
Outershield® XLH-70	D-64

Low Alloy, All Position

UltraCore® 81NiA75-H	D-66
UltraCore® 81Ni1C-H	D-68
UltraCore® 81Ni1C-H Plus	D-70
UltraCore® 81Ni1M-H Plus	D-72
UltraCore® 81Ni2A75-H	D-74
UltraCore® 81Ni2C-H	D-76
UltraCore® 81K2A75-H	D-78
UltraCore® 81K2C-H	D-80
UltraCore® 81K2C-H Plus	D-82
UltraCore® 81K2M-H Plus	D-84
UltraCore® 91K2C-H Plus	D-86
UltraCore® 91K2M-H Plus	D-88
UltraCore® 101K3M-H Plus	D-90
UltraCore® 111K3C-H Plus	D-92
UltraCore® 111K3M-H Plus	D-94
UltraCore® 121K3M-H Plus	D-96
CORMET™ 5	D-98

Low Alloy, Flat and Horizontal

UltraCore® 80Ni1C	D-99
UltraCore® 80Ni1M	D-101

SUBMERGED ARC

Flux

Active Flux

Lincolnweld® 760°	E-1
Lincolnweld® 761°	E-2
Lincolnweld® 780°	E-3
Lincolnweld® 781™	E-4

Neutral Flux

Lincolnweld® 822™	E-5
Lincolnweld® 842-H™	E-6
Lincolnweld® 860°	E-7
Lincolnweld® 865™	E-8
Lincolnweld® 880™	E-9
Lincolnweld® 880M°	E-10
Lincolnweld® 882™	E-11
Lincolnweld® 888™	E-12
Lincolnweld® 8500™	E-13
Lincolnweld® MIL800-H™	E-14
Lincolnweld® 812-SRC™	E-15
Lincolnweld® 960°	E-16
Lincolnweld® 980™	E-17
Lincolnweld® WTX™	E-18
Lincolnweld® WTX™-TR	E-19

Flux for Seam Welding of Pipe

Lincolnweld® 761-Pipe™	E-20
Lincolnweld® P223™	E-21
Lincolnweld® LPX80N™	E-22
Lincolnweld® SPX80™	E-23
Lincolnweld® SPX80N™	E-24
Lincolnweld® 995N™	E-25

High Performance/Alloy Flux

Lincolnweld® A-XXX10™	E-26
Lincolnweld® MIL800-HPNi™	E-27

Solid Wire

Mild Steel Solid Electrode

Lincolnweld® L-50°	E-28
Lincolnweld® L-56°	E-29
Lincolnweld® L-60	E-30
Lincolnweld® L-61°	E-31
Lincolnweld® L-53	E-32
Lincolnweld® LA-71	E-32

Low Alloy Solid Electrode

Lincolnweld® AK-10™	E-33
Lincolnweld® L-70	E-34
Lincolnweld® LA-75	E-34

Lincolnweld® LA-81	E-35
Lincolnweld® LA-84	E-36
Lincolnweld® LA-85	E-37
Lincolnweld® LA-90	E-38
Lincolnweld® LA-100	E-39

Cored Wire

Mild Steel

Lincolnweld® LC-72	E-40
--------------------------	------

Low Alloy

Lincolnweld® LAC-B2	A-41
Lincolnweld® LAC-Ni2	E-42
Lincolnweld® LAC-690	E-43

Non-Copper Coated Submerged Arc (SAW) Electrode

Mild Steel Solid Electrode

Lincolnweld® Emergence™ 61	E-41
Lincolnweld® Emergence™ 73	E-42

Low Alloy Solid Electrode

Lincolnweld® Emergence™ 70	E-43
Lincolnweld® Emergence™ 81	E-44
Lincolnweld® Emergence™ 90	E-45

STAINLESS

Stick Electrode

Excalibur® 308/308L-15	F-1
Excalibur® 308L-16	F-2
Excalibur® 308/308H-16	F-3
Excalibur® 308/308L-17	F-4
Excalibur® 309/309L-15	F-5
Excalibur® 309/309L-16	F-6
Excalibur® 309/309L-17	F-7
Excalibur® 310-16	F-8
Excalibur® 312-16	F-9
Excalibur® 316/316L-15	F-10
Excalibur® 316/316L-16	F-11
Excalibur® 316/316L-17	F-12
Excalibur® 317L	F-13
Excalibur® 320LR-16	F-14
Excalibur® 330-16	F-15
Excalibur® 347-16	F-16
Excalibur® 385-16	F-17
Excalibur® 410-16	F-18
Excalibur® 410NiMo-16	F-19
Excalibur® 630-16	F-20

Excalibur® 2209-16 F-21
 Excalibur® 2594-16 F-22
 E16.8.2-15 F-23
 Supermet™ 16.8.2 F-24
 Thermet™ 800Nb F-25
 Ultramet® 308LCF F-26
 UltraMet B™ 316 NF F-27

MIG Wire

Blue Max® MIG 307 MOD F-28
 Blue Max® MIG 308H F-29
 Blue Max® MIG 308LSi F-30
 Blue Max® MIG 308L F-32
 Blue Max® MIG 308LCF F-33
 Blue Max® MIG 309LSi F-34
 Blue Max® MIG 309L F-36
 Blue Max® MIG 309LMO_MOD F-38
 Blue Max® MIG 310 F-39
 Blue Max® MIG 312 F-40
 Blue Max® MIG 316L F-41
 Blue Max® MIG 316LCF F-42
 Blue Max® MIG 316LSi F-43
 Blue Max® MIG 317L F-45
 Blue Max® MIG 320LR F-46
 Blue Max® MIG 330 F-47
 Blue Max® MIG 347 F-48
 Blue Max® MIG 385 F-49
 Blue Max® MIG 409Nb F-50
 Blue Max® MIG 410 F-51
 Blue Max® MIG 410NiMo F-52
 Blue Max® MIG 420 F-53
 Blue Max® MIG 630 F-54
 Blue Max® MIG 2209 F-55
 Blue Max® MIG 2594 F-56
 Lincoln® Red Max™ 308LSi F-57
 Lincoln® Red Max™ 309LSi F-59
 Lincoln® Red Max™ 316LSi F-61
 Lincoln® Red Max™ 307_MOD F-63
 Murex® 308LSi F-65
 Murex® 309LSi F-66
 Murex® 316LSi F-67

Flux-Cored (FCAW-G) Wire

UltraCore® 308L F-68
 UltraCore® 308L P F-70
 UltraCore® 309L F-72
 UltraCore® 309L P F-74
 UltraCore® FC 316L F-76
 UltraCore® 316L P F-78

Supercore™ 308LCF F-80
 Supercore™ 316LCF F-81
 Supercore™ 347 F-82
 Supercore™ 2205P F-83
 Supercore™ 2507P F-84
 Supercore™ 308HP F-85
 Supercore™ 317LP F-86
 Supercore™ 16.8.2P F-87
 Supercore™ Z100XP F-88

Submerged Arc Wire

Lincolnweld® 308/308L F-89
 Lincolnweld® 308/308H F-90
 Lincolnweld® 308/308LCF F-91
 Lincolnweld® 309 LMO_MOD F-92
 Lincolnweld® 309/309L F-93
 Lincolnweld® 310 F-95
 Lincolnweld® 316/316LCF F-96
 Lincolnweld® 316/316L F-97
 Lincolnweld® 317/317L F-99
 Lincolnweld® 320LR F-100
 Lincolnweld® 347 F-101
 Lincolnweld® 385 F-102
 Lincolnweld® 410NiMo F-103
 Lincolnweld® 630 F-104
 Lincolnweld® 2209 F-105
 Lincolnweld® 2594 F-106
 ER16.8.2 F-107

Submerged Arc Flux

Lincolnweld® P2000™ F-108
 Lincolnweld® P2007™ F-109
 Lincolnweld® ST-100™ F-110

TIG Cut Length

Lincoln® ER308/308H F-111
 Lincoln® ER308/308L F-112
 Lincoln® ER308/308LCF F-113
 Lincoln® ER308Si/308LSi F-114
 Lincoln® ER309/309L F-115
 Lincoln® ER309Si/309LSi F-116
 Lincoln® ER310 F-117
 Lincoln® ER312 F-118
 Lincoln® ER316/316L F-119
 Lincoln® ER316/316LCF F-120
 Lincoln® ER316Si/316LSi F-121
 Lincoln® ER317/317L F-122
 Lincoln® ER320LR F-123
 Lincoln® ER347 F-124
 Lincoln® ER385 F-125

Lincoln® ER409Nb F-126
 Lincoln® ER410 F-127
 Lincoln® ER410NiMo F-128
 Lincoln® ER630 F-129
 Lincoln® ER2209 F-130
 Lincoln® ER2594 F-131
 ER16.8.2 F-132

Metal-Cored Wire

PRIMALLOY™ T-409Ti F-133
 PRIMALLOY™ T-439Ti F-134
 PRIMALLOY™ T-430LNb F-135
 PRIMALLOY® T-439Nb F-136

Orbital TIG [GTAW] Wire

Blue Max® Orbital TIG 308/308L F-137
 Blue Max® Orbital TIG 309/309L F-138
 Blue Max® Orbital TIG 316/316L F-139

NICKEL

Stick [SMAW] Electrode

Tech-Rod® 55 G-1
 Tech-Rod® 99 G-2
 Tech-Rod® 112 G-3
 Tech-Rod® 112LFe G-4
 Tech-Rod® 117 G-5
 Tech-Rod® 122 G-6
 Tech-Rod® 141 G-7
 Tech-Rod® 182 G-8
 Tech-Rod® 187 G-9
 Tech-Rod® 190 G-10
 Tech-Rod® 276 G-11
 Tech-Rod® Weld A G-12

MIG/TIG/SAW Wire

Techalloy® 55 G-13
 Techalloy® 99 G-14
 Techalloy® 208 G-15
 Techalloy® 276 G-16
 Techalloy® 413 G-17
 Techalloy® 418 G-18
 Techalloy® 606 G-19
 Techalloy® 617 G-20
 Techalloy® 622 G-21
 Techalloy® 625 G-22
 Techalloy® 686 G-23

Techalloy® 718 G-24
 Techalloy® 825 G-25
 Techalloy® X G-26

Flux-Cored [FCAW-G] Wire

SuperCore® 625P G-27

HARDFACING

Selection Guide by Application H-i
Stick [SMAW] Electrode

Build-Up

Wearshield® BU H-1

Metal-to-Metal Wear

Wearshield® MI H-2
 Wearshield® Mangjet® H-3

Severe Impact

Wearshield® 15CrMn H-4
 Wearshield® FROG MANG® H-5
 Wearshield® Super Rail™ H-6

Abrasion and Impact

Wearshield® ABR H-7
 Wearshield® 44 H-8

Metal-to-Earth Wear

Wearshield® ME H-9

Severe Abrasion

Wearshield® 60 H-10
 Lincoln® SHS® 9700E H-11

Maintenance and Repair

Blue Max® 2100 H-12

Metal-Cored [GMAW-C] Wire

Severe Abrasion

Lincore® 57-G H-13
 Lincore® 60-G H-14
 Lincore® 70-G H-15

Metal-to-Metal

Lincore® M7-G H-16
 Lincore® 55-G H-17

Metal-Cored Submerged Arc Wire

Build-Up

Lincore® 30-S H-18

Metal-to-Metal, Build Up			
Lincore® 32-S	H-19	Lincore® 70-0	H-50
Lincore® 35-S	H-20	Lincore® TiCore	H-51
Metal-to-Metal		Lincore® 65 PLUS	H-52
Lincore® 40-S	H-21	Lincoln® SHS® 9800U	H-53
Lincore® 42-S	H-22	Lincoln® SHS® 9700U	H-54
Roll Rebuilding, Build Up		Lincoln® SHS® 9192U	H-55
Lincore® 20	H-23	Lincoln® SHS® 9500U	H-56
Lincore® 420HC-S	H-24		
Lincore® 4130	H-25	Submerged Arc (SAW) Flux	
Lincore® 8620	H-26	Hardfacing	
Roll Rebuilding, Metal-to-Metal		Lincolnweld® A-96-S	H-57
Lincore® 410	H-27	Lincolnweld® H-535™	H-57
Lincore® 410NiMo	H-28	Lincolnweld® H-560™	H-58
Lincore® 423L	H-29	Neutral Flux	
Lincore® 423Cr	H-30	Lincolnweld® 801®	H-59
Lincore® 420	H-30	Lincolnweld® 802®	H-59
Lincore® 414N	H-31		
Lincore® 423N	H-32	Hardbanding Cored Wire	
Lincore® 96S	H-33	Severe Abrasion	
Lincore® 102W	H-34	Lincoln® Guardian® HB	H-60
Lincore® 102HC	H-35	Lincoln® Guardian® CF	H-61
Flux-Cored (FCAW-G) Wire		Wire Arc Spray	
Build-Up		Severe Abrasion	
Lincore® BU-G	H-36	Lincoln® SHS® 7570W	H-62
Flux-Cored (FCAW-S) Wire		Lincoln® SHS® 8000W	H-63
Build-Up		Lincoln® SHS® 9172W	H-64
Lincore® BU	H-37		
Lincore® 33	H-38	Thermal Spray Powder	
Metal-to-Metal		Severe Abrasion	
Lincore® 40-0	H-39	Lincoln® SHS® 7574HV	H-65
Lincore® 55	H-40	Lincoln® SHS® 8000HV	H-66
Lincore® T & D	H-41	Lincoln® SHS® 9172HV	H-67
Severe Impact		Plasma Transferred Arc Weld Powder (PTAW)	
Lincore® M	H-42	Severe Abrasion	
Lincore® 15CrMn	H-43	Lincoln® SHS® 9294P	H-86
Lincore® FROG MANG®	H-44	Lincoln® SHS® 9700P	H-87
Lincore® Super Rail™	H-45		
Abrasion Plus Impact		CHROME-MOLY	
Lincore® 50	H-46	Selection Guide by Alloy Grade	I-i
Severe Abrasion		Stick (SMAW) Electrode	
Lincore® 60-0	H-47	Low Alloy, Low Hydrogen	
Lincore® Ultra K	H-48	Chromet® 92	I-1
Lincore® 65-0	H-49	Chromet® 1X	I-2
		Chromet® 2X	I-3
		Chromet® 9	I-4

Chromet® 9-B9.....	I-5
Chromet® 9MV-N.....	I-6
Cromo E225.....	I-7
Cromo E225V.....	I-8
Chromet® 5.....	I-9

MIG/TIG Electrode

Low Alloy, Copper Coated

ER80S-B2.....	I-10
9CRMO.....	I-11
ER90S-B3.....	I-12

Low Alloy Steel

9CRMOV MIG.....	I-13
Lincoln® ER80S-B2.....	I-14
Lincoln® ER90S-B3.....	I-15
9CRMOV-N.....	I-16
5CRMO TIG.....	I-17
Carborod W 225V.....	I-18
9CRWV TIG.....	I-19

Orbital TIG (GTAW) Wire

Low Alloy Steel

Superarc® Orbital TIG ER80S-B2.....	I-20
Superarc® Orbital TIG ER90S-B3.....	I-21

Submerged Arc (SAW) Electrode

Low Alloy Solid Electrode

9CRWV SAW.....	I-22
9CRMO.....	I-23
5CRMO SAW.....	I-24
Lincolnweld® LA-92.....	I-25
Lincolnweld® LA-93.....	I-26
OE-S1 CRM091.....	I-27
9CRMOV-N.....	I-28

Submerged Arc (SAW) Flux

Low Alloy Flux

OP 90W.....	I-29
OP CROMO F537.....	I-30

Special Neutral Flux

LA490.....	I-31
------------	------

Flux-Cored (FCAW-G) Wire

Low Alloy, All Position

Supercore® F91.....	I-32
Cormet™ 1.....	I-33
Cormet™ 2.....	I-34

ALUMINUM & CAST IRON

Aluminum

MIG Wire

SuperGlaze® 4043.....	J-1
SuperGlaze® 4047.....	J-2
SuperGlaze® 5183.....	J-3
SuperGlaze® HD 5183.....	J-4
SuperGlaze® 5356.....	J-5
SuperGlaze® HD 5356.....	J-6
SuperGlaze® 5356 TM™.....	J-7
SuperGlaze® HD 5356 TM™.....	J-8
SuperGlaze® 5554.....	J-9
SuperGlaze® 5556.....	J-10
SuperGlaze® HD 5556.....	J-11

TIG Cut Length

SuperGlaze® 4043.....	J-12
SuperGlaze® 5356.....	J-13

Cast Iron

Stick Electrode

Ferroweld®.....	J-13
-----------------	------

Additional Information

Typical Joint Designs.....	J-14
Typical Operating Procedures.....	J-15

PIPELINER®

Stick (SMAW) Electrode

Mild Steel, Cellulosic

Pipeliners® 6P+.....	K-1
----------------------	-----

Mild Steel, Low Hydrogen

Pipeliners® 16P.....	K-2
----------------------	-----

Low Alloy, Cellulosic

Pipeliners® 7P+.....	K-3
Pipeliners® 8P+.....	K-4
Pipeliners® Arc 80.....	K-5

Low Alloy, Low Hydrogen

Pipeliners® LH-D80.....	K-6
Pipeliners® LH-D90.....	K-7
Pipeliners® LH-D100.....	K-8
Pipeliners® 19P.....	K-9

MIG (GMAW) Wire

Mild and Low Alloy Steel Pipe

Pipeliner® 70S-6..... K-10
 Pipeliner® 70S-G K-11
 Pipeliner® 80Ni1..... K-12

Flux-Cored Self-Shielded (FCAW-S) Wire

Low Alloy, All Position

Pipeliner® NR®-207+ K-13
 Pipeliner® NR®-208-P..... K-14
 Pipeliner® NR®-208-XP K-15

Flux-Cored Gas-Shielded (FCAW-G) Wire

Low Alloy, All Position

Pipeliner® 81M K-16
 Pipeliner® 91M K-17
 Pipeliner® 101M K-18
 Pipeliner® 111M K-19
 Pipeliner® G90M K-20

Additional Information

Pipe Grades..... K-21
 Electrode Selection Guide..... K-22
 LH-D80/90/100 Welding Guidelines..... K-23
 EN and ISO Classifications..... K-24
 Agency Approvals K-26

POWER GENERATION & NUCLEAR (LOT CONTROLLED)

Additional Information

Q2 Lot Certificates Center Overview..... L-1
 Nuclear Products / Batch Managed Overview L-2

Stick (SMAW) Electrode

Mild Steel

Excalibur® 7018 MR® N* L-3

Low Alloy Steel

Excalibur® 8018-B2 MR® L-5
 Excalibur® 9018-G MR® N..... L-7

MIG (GMAW) Wire

Mild Steel

SuperArc® L-56° N* L-9

Low Alloy Steel

SuperArc® AK-10 L-11
 SuperArc® LA-75* L-13

Stainless Steel

Blue Max® MIG 308L N* L-15
 Blue Max® MIG 309L N* L-17
 Blue Max® MIG 316L N* L-19
 Blue Max® LNM 4462 N* L-21

TIG (GTAW) Cut Lengths

Low Alloy Steel

Lincoln® ER100S-1..... L-22

Stainless Steel

Lincoln® ER308/308L N* L-23
 Lincoln® ER309/309L N* L-24
 Blue Max® LNT 4462 N* L-25

TIG (GTAW) Cut Lengths - Orbital

Mild Steel

SuperArc® Orbital TIG L-52 N* L-26
 SuperArc® Orbital TIG L-56° N* L-27
 Blue Max® Orbital TIG 308/308L N* L-28
 Blue Max® Orbital TIG 309/309L N* L-29
 Blue Max® Orbital TIG 316/316L N* L-30

Low Alloy Steel

SuperArc® Orbital TIG AK-10..... L-31

Submerged Arc (SAW) Flux & Wire Combinations

Low Alloy Steel

Lincolnweld® MIL800-H &
 Lincolnweld® LA-84..... L-32
 Lincolnweld® MIL-800-H &
 Lincolnweld® LA-100..... L-33

Stainless Steel

Lincolnweld® P2007™ &
 Lincolnweld® 308/308L L-34
 Lincolnweld® P2007™ &
 Lincolnweld® 309/309L L-35
 Lincolnweld® P2007™ &
 Lincolnweld® 316/316L L-36

Flux-Cored (FCAW-G) Wire

Mild Steel

UltraCore® 71A85* L-37
 UltraCore® SR-12H L-39

*These products are available as Batched Managed Inventory

PACKAGING

Options

Tubes, Cans & Cartons.....	M-1
Reels & Stem.....	M-3
Spools.....	M-5
Coils, Boxes & Bags.....	M-7
Drums & Pails.....	M-9

Storage and Handling

Stick Electrode.....	M-11
Stainless Steel & Nickel.....	M-12
Metal-Cored & Flux-Cored Wire.....	M-13
Submerged Arc Flux & Wire.....	M-14
Accu-Pak® Box.....	M-15

APPENDIX

AWS Classification System

Stick (SMAW).....	N-1
MIG (GMAW), TIG (GTAW) & Metal-Cored (GMAW-C).....	N-2
Flux-Cored (FCAW).....	N-3
Submerged Arc (SAW) Flux & Electrode.....	N-6

General Information

Stick Electrode

Types of Coating & Current.....	N-8
ASME Boiler & Pressure Vessel Code.....	N-9

Submerged Arc

Flux Types & General Characteristics.....	N-10
Selecting Flux/Wire Combinations.....	N-11

Innershield®

Wire Selection Guide.....	N-13
---------------------------	------

Hardfacing

Cross Checking.....	N-15
---------------------	------

<i>Agency Approvals</i>	M-16
-------------------------------	------

<i>Safety Guidelines</i>	N-17
--------------------------------	------

Lincoln Electric is focused on helping companies make their welding operations more effective, more efficient and more profitable. We are dedicated to two equally important goals: exceptional quality and exceptional service. Our field support team – with hundreds of field sales engineers and thousands of knowledgeable and responsive Lincoln Electric distributors in countries all over the world – is the largest in the industry. Lincoln Electric’s innovative thinking, fresh approach to design and a quality-first attitude presents our customers with worldwide strength and support.

INDUSTRY-LEADING CONSISTENCY

Consistency is critical to the strength and appearance of every weld. Lincoln Electric quality starts with superior materials – incoming raw steel slated for use in consumables is analyzed for chemical composition, checking more than 20 different elements before being cleared for production. The result is a line of weld consumables that are reliably uniform in diameter and chemical composition. In fact, Lincoln Electric standards are considerably more restrictive than AWS requirements.



BETTER MANUFACTURING SYSTEMS

Lincoln Electric employs the most technically advanced and carefully monitored manufacturing and quality control systems in the welding industry. The result is a line of weld consumables that are reliably uniform.

INDUSTRY SOLUTIONS

Lincoln Electric is committed to developing welding solutions that meet the unique needs of our customers, worldwide. Becoming Lincoln Electric’s global partner provides your company with specialized, industry-tested equipment and consumables created to meet industry specific welding requirements. Whether your company manufactures pipelines, wind towers or offshore oil rigs, choosing Lincoln Electric ensures maximum productivity, quality and profitability for our customers.

THE SYMBOL OF DEPENDABILITY

Our stick electrodes have been the number one choice of fabricators for over a century. They are easily identified by three dots, which are a symbol of quality, consistency, and unparalleled welding expertise. When only the best will do, there is no substitute for a Lincoln Electric stick electrode.

Q LOT CERTIFICATIONS



CERTIFICATION TO MEET YOUR NEEDS

Lincoln Electric offers three levels of Q Lot Certification. While each is indicative of a unique set of tests, traceabilities and records, all Q Lot Certs share a common heritage grounded in chemical composition control and Lincoln Electric's Six Sigma driven production system. No matter which Q Lot Cert you require – from our standard Q1 Lot® Cert to our comprehensive and exacting Q3 Lot® Cert, you get the peace-of-mind that comes from knowing that you can count on the performance of your welding consumables.

	Q1	Q2	Q3
Lincoln Electric standard ISO manufacturing system	▪	▪	▪
Certificates of conformance	▪	▪	▪
Lincoln Electric Q Lot number on product meets AWS A5.01 lot definition requirements	▪	▪	▪
Link Q Lot number to certificate of conformance	▪	▪	▪
Traceable to Lincoln manufacturing date, shift and operator	▪	▪	▪
Recorded flux/mix chemistry	▪	▪	▪
Items below represent additional agency requirements for testing and traceability			
Independent verification of records		▪	▪
Recorded steel chemistry		▪	▪
Lot control number per a specification (ASME code, for instance)		▪	▪
Testing per specification (when required)		▪	▪
Independent verification of all tests		▪	▪
Test results traceable to Lincoln archived records		▪	▪
Certification with test results issued to customer			▪
Certification with test results traceable from Lincoln Electric to customer			▪
Lincoln Electric keeps records on file			▪
Certification issued to customer			▪

Lincoln Electric's Quality System is derived from controlled chemical composition of steel. Our Q Lot System is comprised of three comprehensive levels:

Q1 LOT® – Lincoln Electric's standard manufacturing and Quality Assurance System. We start by evaluating the raw materials, analyzing the nose and tail end of each green rod coil for chemical composition ensuring it meets Lincoln's stringent requirements. Our tight tolerances go beyond AWS requirements to ensure consistency in product chemistry, mechanical properties and operation. Providing traceability to the date of manufacture, operator, line and shift.

Examples: Standard commercial products. Products have and AWS certificate of conformance.

Q2 LOT® – Comprised of Q1 Lot®, plus archived lot controlled records of in-process testing and manufacturing, as well as actual and deposit composition test results of the finished product. Providing traceability to the date of manufacture, operator, line and shift.

Examples: Stainless, Nickel, Pipeliner® and all Batch Managed Inventory. Products have Certified Material Test Reports (CMTR's, 3.1)

Q3 LOT® – Comprised of Q2 Lot®, plus special testing requirements and archived records for a specific shipment or customer. Product is made to order per customer's requirements.

Examples: Military and Nuclear certification. Products have Certified Material Test Reports (CMTR's, 3.1)

EN CERTIFICATIONS

EN 10204 INSPECTION DOCUMENTS	TESTING LEVELS PER AWS A5.01 FILLER METAL PROCUREMENT GUIDELINES	EXAMPLES OF LINCOLN ELECTRIC OPTIONS
<p>Type 2.1 States "Products are in compliance with requirements of the order (WITHOUT any test results).</p>	<p>Schedule F The level of testing shall be the manufacturer's standard. A statement, "the product supplied will meet the requirements of the applicable AWS standard, when tested in accordance with that standard" and a summary of the typical properties of the material, when tested in that manner, shall be supplied upon written request.</p>	<p>Lincoln Electric "3 year" Certificate of Conformance applicable to a Q1 Lot®.</p>
<p>Type 2.2 States "Products are in compliance with requirements of the order (includes non-specific test results – NOT ACTUALS from the lot in question).</p>	<p>Schedule G Test results shall be supplied from any production run of the product made within the twelve months preceding the date of the purchase order. This shall include the results of all tests prescribed for that classification in the AWS standard.</p>	<p>Lincoln Electric "1 year" Certificate of Conformance applicable to a Q1 Lot®.</p>
<p>Type 3.1 States "Products are in compliance with requirements of the order and includes ACTUAL test results for some requirements, but not all.</p>	<p>Schedule H Chemical analysis of each lot shipped shall be supplied by the manufacturer. The analysis shall include those elements prescribed for that classification in the AWS standard."</p>	<p>Lincoln Electric "Q1 with Schedule H" Certificate of Actual Results on each S4 lot of SAW wire. Lincoln Electric "Q2" Certified Material Test Reports for stainless products.</p>
	<p>Schedule I Actual results of the tests called for in Table 2 of AWS A5.01 shall be supplied by the manufacturer for each lot shipped. These tests represent a consensus of those frequently requested for consumables certification; however, they do not necessarily include all tests required for Schedule J. The tests shall be performed as prescribed for that classification in the AWS standard.</p>	<p>Lincoln Electric "Q2" Certified Material Test Reports for products such as Pipeliner® brand.</p>
	<p>Schedule J Actual results of all of the tests prescribed for that classification in the AWS standard shall be supplied by the manufacturer for each lot shipped."</p>	<p>Lincoln Electric "Q2" Certified Material Test Reports for stainless solid wires such as BlueMax® MIG, Lincolnweld® stainless subarc wires, and Lincoln® stainless cut length products.</p>
	<p>Schedule K In addition to, or in place of, any of the tests called for in the AWS standard, the purchaser may require other tests (such as testing after a specified heat treatment). In all such cases, the purchaser shall identify on the purchase order the specific tests that are to be conducted, the procedures to be followed, the requirements that shall be met and the results to be reported by the manufacturer.</p>	<p>Lincoln Electric "Q3" Certified Material Test Reports to specific customer requirements. Lincoln Electric "Q1 with Schedule K" Certificate of Actual Results for composition on each lot of SAW flux.</p>

CATALOG USER GUIDE

1 CATALOG SECTION

2 BRAND NAME

3 PRODUCT CATEGORY SECTION

5 KEY FEATURES

8 WELDING POSITIONS

10 DIAMETERS & PACKAGING

11 MECHANICAL PROPERTIES

12 WIRE/DEPOSIT/CHEMICAL COMPOSITION

13 TYPICAL OPERATING PROCEDURES

C€

PIPELINER® MIG (GMAW) WIRE

PIPELINER® 70S-G

Mild & Low Alloy Steel Pipe • AWS ER70S-G

KEY FEATURES

- Root pass capability up to API Grade X100 and hot, fill and cap pass up to X70 grade pipe
- Good back bead shape on STT® root passes
- Q2 Lot® - Certificates showing actual wire composition and actual mechanical properties available online
- Low silicon level for minimal clean-up
- ProTech® packaging system

CONFORMANCES

AWS A5.18/A5.18M: 2005 ER70S-G
ASME SFA-A5.18: ER70S-G
EN ISO 14341-B: G 49A Z C SZ

WELDING POSITIONS

All

TYPICAL APPLICATIONS

- Root pass welding of up to X100 grade pipe
- Hot, fill and cap pass welding of up to X70 grade pipe

DIAMETERS / PACKAGING

Diameter in (mm)	10 lb (4.5 kg) Plastic Spool (Vacuum Sealed Foil Bag)	25 lb (11.3 kg) Plastic Spool (Vacuum Sealed Foil Bag)
0.045 (1.1)	ED030904	ED030905

SHIELDING GAS

100% CO₂
 75-95% Argon / Balance CO₂
 Flow Rate: 30 - 50 CFH

MECHANICAL PROPERTIES⁽¹⁾ – As Required per AWS A5.18/A5.18M: 2005

	Yield Strength ⁽²⁾ MPa (ksi)	Tensile Strength MPa (ksi)	Elongation %	Charpy V-Notch J (ft-lbf) @ -29°C (-20°F)
Requirements - AWS ER70S-G As-Welded with 100% CO ₂	400 (58) min.	485 (70) min.	22 min.	Not Specified
Typical Results⁽³⁾ As-Welded with 100% CO ₂	405-425 (59-62)	510-40 (74-78)	24-26	54-81 (40-60)

WIRE COMPOSITION – As Required per AWS A5.18/A5.18M: 2005

	%C	%Mn	%Si	%S	%P	%Cu
Requirements - AWS ER70S-G	Not Specified					
Typical Results⁽³⁾	0.05-0.15	0.80-1.40	0.30-0.60	≤0.02	≤0.02	≤0.02

TYPICAL OPERATING PROCEDURES

Diameter, Polarity	CTWD ⁽⁴⁾ mm (in)	Wire Feed Speed m/min (in/min)	Voltage (volts)	Approx. Current (amps)	Melt-Off Rate kg/hr (lb/hr)
1.1 mm (0.045 in), DC+	12-19 (1/2-3/4)	3.2-12.7 (125-500)	19-30	145-340	1.5-6.0 (3.4-13.2)

⁽¹⁾Typical of weld metal. ⁽²⁾Measured with 0.25 offset. ⁽³⁾See test results disclaimer on pg. 18. ⁽⁴⁾CTWD (Contact Tip to Work Distance). Subtract 1/4 in. (6.4 mm) to calculate Electrical Stickout.

394 | www.lincolnelectric.com

4 CLASSIFICATION

6 CONFORMANCES

7 TYPICAL APPLICATIONS

9 SHIELDING GAS

- 1 Refer to the top of each page for a reference to the consumable category.
- 2 The name of each product appears in the top left or right corner of each page.
- 3 Each consumable section of the catalog has subcategories to further define each product.
- 4 AWS or EN classification.
- 5 Top features of each product.
- 6 Every specification and conformance to which the product is tested.
- 7 List of where customers typically use product.
- 8 Flat and Horizontal or All Position capability.
- 9 Recommended shielding gas in order of performance and (where applicable).
- 10 Diameters and packaging available for each product (manufactured to the unit of measurement listed first).
- 11 Details the AWS mechanical property requirements and typical test results for each product's weld deposit.
- 12 Details the AWS chemical composition content requirements and typical wire composition or deposit composition results.
- 13 Recommended operating ranges and resulting melt-off and/or deposition rates for each product diameter.

SMAW CONSUMABLES

STICK

EXCALIBUR® 7018 MR®

Mild Steel, Low Hydrogen · AWS E7018 H4R



KEY FEATURES

- Extreme bend ability
- Excellent moisture resistance
- Clean arc starts

CONFORMANCES

- AWS A5.1: E7018 H4R
- ABS: 3YH5
- CWB/CSA: E4918
- DNV-GL: 3YH5
- Lloyd's Register: 3YM H5
- BV: 3YHHH
- ISO: E4918 A H5

TYPICAL APPLICATIONS

- Mild steel
- Chemical Processing Structures
- General fabrication
- Structural
- Ship Building

WELDING POSITIONS

All, except vertical down

DIAMETERS/PACKAGING

Diameter in (mm)	Length in (mm)	1 lb (0.5 kg) Plastic Tube 6 lb (2.7 kg) Master Carton	10 lb (4.5 kg) Easy Open Can 30 lb (13.6 kg) Master Carton	50 lb (22.7kg) Easy Open Can
3/32 (2.4)	14 (350)	ED032086	ED032588	ED028280, ED033868*
1/8 (3.2)	14 (350)	ED031468	ED032589	ED028281, ED033869*
5/32 (4.0)	14 (350)		ED032590	ED028282, ED033870*
3/16 (4.8)	14 (350)			ED028283, ED033871*
7/32 (5.6)	18 (450)			ED028917
1/4 (6.4)	18 (450)			ED028918

*Buy America Product

MECHANICAL PROPERTIES⁽¹⁾ – As Required per AWS A5.1

	Yield Strength ⁽²⁾ MPa (ksi)	Tensile Strength MPa (ksi)	Elongation %	Charpy V-Notch J (ft-lbf) @ -29°C (-20°F)
Requirements - AWS E7018 H4R	400 (58) min	490 (70) min	22 min	27 (20) min
Typical Results ⁽³⁾ - As-Welded	430-510 (62-74)	510-605 (74-88)	25-37	121-332 (89-246)

DEPOSIT COMPOSITION⁽¹⁾ – As Required per AWS A5.1

	%C	%Mn	%Si	%P	%S	%Ni
Requirements - AWS E7018 H4R	0.15 max	1.60 max	0.75 max	0.035 max	0.035 max	0.30 max
Typical Results ⁽³⁾	0.03-0.08	1.01-1.55	0.34-0.68	0.01-0.02	≤ 0.01	0.01-0.06
	%Cr	%Mo	%V	%Mn + Ni + Cr + Mo + V	Diffusible Hydrogen (mL/100g weld metal)	
Requirements - AWS E7018 H4R	0.20 max	0.30 max	0.08 max	1.75 max	4.0 max	
Typical Results ⁽³⁾	0.02-0.07	≤ 0.05	≤ 0.02	1.04-1.75	2-3	

TYPICAL OPERATING PROCEDURES

Polarity ⁽⁴⁾	Current (Amps)					
	3/32 in (2.4 mm)	1/8 in (3.2 mm)	5/32 in (4.0 mm)	3/16 in (4.8 mm)	7/32 in (5.6 mm)	1/4 in (6.4 mm)
DC+	70-110	90-160	130-210	180-300	250-330	300-400
AC	80-120	100-160	140-210	200-300	270-370	325-420

⁽¹⁾Typical all weld metal. ⁽²⁾Measured with 0.2% offset. ⁽³⁾See test results disclaimer. ⁽⁴⁾Preferred polarity is listed first.

IRONARC™ 7018 MR®

Mild Steel, Low Hydrogen · AWS E7018 H4R

KEY FEATURES

- Soft arc for ease of puddle manipulation
- Smooth arc transfer
- Excellent wetting in the toes allowing for less hold times
- Flat bead profile ideal for cap passes on pipe, groove welds and pipe repair
- No intentional addition of zinc for moisture resistance

TYPICAL APPLICATIONS

- Pipeline, pipe repair and integrity work
- Boiler, pressure vessel fabrication and repair
- Pipefitting
- Structural fabrication
- General fabrication

DIAMETERS / PACKAGING

Diameter in (mm)	Length in (mm)	10 lb (4.5 kg) Easy Open Can	50 lb (22.7kg) Easy Open Can
3/32 [2.4]	14 [350]		ED040000
1/8 [3.2]	14 [350]		ED040001
5/32 [4.0]	14 [350]		ED040002
3/16 [4.8]	14 [350]	ED040003	

CONFORMANCES

AWS A5.1: E7018 H4R

CWB CSA W48: E4918-H4R

WELDING POSITIONS

All, except vertical down

<https://promotions.lincolnelectric.com/ironarc/>

MECHANICAL PROPERTIES⁽¹⁾ – As Required per AWS A5.1

	Yield Strength ⁽²⁾ MPa [ksi]	Tensile Strength MPa [ksi]	Elongation %	Charpy V-Notch J [ft-lbs] @-29°C [-20°F]
Requirements - AWS E7018 H4R	400 [58] min	480 [70] min	22 min	27 [20] min
Typical Results⁽³⁾ - As-Welded	440-480 [64-69]	540-580 [79-84]	29-32	136-176 [100-130]

DEPOSIT COMPOSITION⁽¹⁾ – As Required per AWS A5.1

	%C	%Mn	%Si	%P	%S	%Ni
Requirements - AWS E7018 H4R	0.15 max	1.60 max	0.75 max	0.035 max	0.035 max	0.30 max
Typical Results⁽³⁾	0.05-0.07	1.25-1.37	0.41-0.62	0.010-0.013	0.011-0.017	0.00-0.03
	%Cr	%Mo	%V	%Mn + Ni + Cr + Mo + V	Diffusible Hydrogen (mL/100g weld metal)	
Requirements - AWS E7018 H4R	0.20 max	0.30 max	0.08 max	1.75 max	4 max	
Typical Results⁽³⁾	0.02-0.05	0.00-0.08	0.01	1.30-1.50	1-3	

TYPICAL OPERATING PROCEDURES

Polarity ⁽⁴⁾	Current (Amps)		
	3/32 in [2.4mm]	1/8 in [3.2mm]	5/32 in [4.0mm]
DC+	70-110	90-160	120-220
AC	80-120	100-160	130-220

⁽¹⁾Typical all weld metal. ⁽²⁾Measured with 0.2% offset. ⁽³⁾See test results disclaimer ⁽⁴⁾Preferred polarity is listed first.

EXCALIBUR® 7018 XMR™

Mild Steel, Low Hydrogen · AWS E7018 H4R

KEY FEATURES

- 60% less moisture pickup vs. competition
- 24 hour moisture resistance in H4R conditions
- Improved coating integrity
- Extreme bendability

TYPICAL APPLICATIONS

- Structural
- Chemical Processing
- Ship Building

CONFORMANCES

AWS A5.1:	E7018 H4R
ABS:	3YH5
CWB/CSA:	E4918
DNV-GL:	3YH5
Lloyd's Register:	3YM H5
BV:	3YHHH
ISO:	E4918 A H5

WELDING POSITIONS

All, except vertical down

DIAMETERS / PACKAGING

Diameter in (mm)	Length in (mm)	10 lb (4.5 kg) Easy Open Can 30 lb (13.6 kg) Master Carton	50 lb (22.7kg) Easy Open Can
3/32 (2.4)	14 (350)	ED037425	ED037422
1/8 (3.2)	14 (350)	ED037426	ED037423
5/32 (4.0)	14 (350)	ED037427	ED037424

MECHANICAL PROPERTIES⁽¹⁾ – As Required per AWS A5.1

	Yield Strength ⁽²⁾ MPa (ksi)	Tensile Strength MPa (ksi)	Elongation %	Charpy V-Notch J (ft-lbf) @ -29°C (-20°F)
Requirements - AWS E7018 H4R	400 (58) min	490 (70) min	22 min	27 (20) min
Typical Results ⁽³⁾ - As-Welded	430-510 (62-74)	510-605 (74-88)	25-37	121-332 (89-246)

DEPOSIT COMPOSITION⁽¹⁾ – As Required per AWS A5.1

	%C	%Mn	%Si	%P	%S	%Ni
Requirements - AWS E7018 H4R	0.15 max	1.60 max	0.75 max	0.035 max	0.035 max	0.30 max
Typical Results ⁽³⁾	0.03-0.08	1.01-1.55	0.34-0.68	0.01-0.02	≤ 0.01	0.01-0.06
	%Cr	%Mo	%V	%Mn + Ni + Cr + Mo + V	Diffusible Hydrogen (mL/100g weld metal)	
Requirements - AWS E7018 H4R	0.20 max	0.30 max	0.08 max	1.75 max	4.0 max	
Typical Results ⁽³⁾	0.02-0.07	≤ 0.05	≤ 0.02	1.04-1.75	2-3	

TYPICAL OPERATING PROCEDURES

Polarity ⁽⁴⁾	Current (Amps)		
	3/32 in (2.4 mm)	1/8 in (3.2 mm)	5/32 in (4.0 mm)
DC+	70-110	90-160	130-210
AC	80-120	100-160	140-210

⁽¹⁾Typical all weld metal. ⁽²⁾Measured with 0.2% offset. ⁽³⁾See test results disclaimer. ⁽⁴⁾Preferred polarity is listed first.

EXCALIBUR® 7018-1 MR®

Mild Steel, Low Hydrogen · AWS E7018-1 H4R



KEY FEATURES

- Exceeds AWS toughness requirements at -50°F
- Extreme bend ability
- Meets Chemical Composition Recommendations of API 751
- Q2 Lot® - Lot Controlled Chemistry and Mechanical Properties

TYPICAL APPLICATIONS

- Power generation
- Chemical Processing Structures
- Pressure vessels
- Pressure piping
- Structural

DIAMETERS / PACKAGING

Diameter in (mm)	Length in (mm)	8 lb (3.6 kg) Easy Open Can 24 lb (10.9 kg) Master Carton	10 lb (4.5 kg) Easy Open Can 30 lb (13.6 kg) Master Carton	50 lb (22.7kg) Easy Open Can
3/32 (2.4)	12 (300)	ED033179	ED032591 ED032592	ED028700, ED034308* ED028702, ED034309* ED028704 ED028706 ED028919 ED028920
3/32 (2.4)	14 (350)			
1/8 (3.2)	14 (350)			
5/32 (4.0)	14 (350)			
3/16 (4.8)	14 (350)			
7/32 (5.6)	18 (450)			
1/4 (6.4)	18 (450)			

*Buy America Product

MECHANICAL PROPERTIES⁽¹⁾ – As Required per AWS A5.1

	Yield Strength ⁽²⁾ MPa (ksi)	Tensile Strength MPa (ksi)	Elongation %	Charpy V-Notch J (ft-lbf) @ -46°C (-50°F)
Requirements - AWS E7018-1 H4R	400 (58) min	490 (70) min	22 min	27 (20) min
Typical Results⁽³⁾ - As-Welded	405-515 (59-75)	530-605 (77-88)	24-36	56-178 (42-131)

DEPOSIT COMPOSITION⁽¹⁾ – As Required per AWS A5.1

	%C	%Mn	%Si	%P	%S	%Ni
Requirements - AWS E7018-1 H4R	0.15 max	1.60 max	0.75 max	0.035 max	0.035 max	0.30 max
Typical Results⁽³⁾	0.04-0.07	0.80-1.44	0.28-0.51	0.006-0.019	0.003-0.013	0.01-0.07
	%Cr	%Mo	%V	%Mn + Ni + Cr + Mo + V	Diffusible Hydrogen (mL/100g weld metal)	
Requirements - AWS E7018-1 H4R	0.20 max	0.30 max	0.08 max	1.75 max	4.0 max	
Typical Results⁽³⁾	0.01-0.07	0.11-0.28	≤ 0.01	0.93-1.65	2-3	

TYPICAL OPERATING PROCEDURES

Polarity ⁽⁴⁾	Current (Amps)					
	3/32 in (2.4 mm)	1/8 in (3.2 mm)	5/32 in (4.0 mm)	3/16 in (4.8 mm)	7/32 in (5.6 mm)	1/4 in (6.4 mm)
DC+	70-110	90-160	130-210	180-300	250-330	300-400
AC	80-120	100-160	140-210	200-300	270-370	325-420

⁽¹⁾Typical all weld metal. ⁽²⁾Measured with 0.2% offset. ⁽³⁾See test results disclaimer ⁽⁴⁾Preferred polarity is listed first.

IRONARC™ 7018-1 MR®

Mild Steel, Low Hydrogen · AWS E7018-1 H4R

KEY FEATURES

- Soft arc for ease of puddle manipulation
- Smooth arc transfer
- Excellent wetting in the toes allowing for less hold times
- Flat bead profile ideal for cap passes on pipe, groove welds and pipe repair
- No intentional addition of zinc for moisture resistance
- Q2 Lot® - Certificate showing actual deposit chemistry and mechanical properties available online

TYPICAL APPLICATIONS

- Pipeline, pipe repair and integrity work
- Boiler, pressure vessel fabrication and repair
- Pipefitting
- Structural fabrication
- General fabrication

CONFORMANCES

AWS A5.1:	E7018-1 H4R
CWB CSA W48:	E4918-1-H4R

WELDING POSITIONS

All, except vertical down

DIAMETERS / PACKAGING

Diameter in (mm)	Length in (mm)	10 lb (4.5 kg) Easy Open Can	50 lb (22.7kg) Easy Open Can
3/32 (2.4)	14 (350)		ED040100
1/8 (3.2)	14 (350)		ED040101
5/32 (4.0)	14 (350)		ED040102
1/16 (4.8)	14 (350)	ED040003	

MECHANICAL PROPERTIES⁽¹⁾ – As Required per AWS A5.1

	Yield Strength ⁽²⁾ MPa (ksi)	Tensile Strength MPa (ksi)	Elongation %	Charpy V-Notch J (ft-lbs) @ -46°C (-50°F)
Requirements - AWS E7018-1 H4R	400 (58) min	480 (70) min	22 min	27 (20) min
Typical Results ⁽³⁾ - As-Welded	440-480 (64-69)	540-580 (79-84)	29-32	84-141 (62-104)

DEPOSIT COMPOSITION⁽¹⁾ – As Required per AWS A5.1

	%C	%Mn	%Si	%P	%S	%Ni
Requirements - AWS E7018-1 H4R	0.15 max	1.60 max	0.75 max	0.035 max	0.035 max	0.30 max
Typical Results ⁽³⁾	0.05-0.07	1.25-1.37	0.41-0.62	0.010-0.013	0.011-0.017	0.00-0.03
	%Cr	%Mo	%V	%Mn + Ni + Cr + Mo + V	Diffusible Hydrogen (mL/100g weld metal)	
Requirements - AWS E7018-1 H4R	0.20 max	0.30 max	0.08 max	1.75 max	4	
Typical Results ⁽³⁾	0.02-0.05	0.00-0.08	0.01	1.30-1.50	1-3	

TYPICAL OPERATING PROCEDURES

Polarity ⁽⁴⁾	Current (Amps)		
	3/32 in (2.4mm)	1/8 in (3.2mm)	5/32 in (4.0mm)
DC+	70-110	90-160	120-220
AC	80-120	100-160	130-220

⁽¹⁾Typical all weld metal. ⁽²⁾Measured with 0.2% offset. ⁽³⁾See test results disclaimer ⁽⁴⁾Preferred polarity is listed first.

EXCALIBUR® 7028

Mild Steel, Low Hydrogen · AWS E7028 H8



KEY FEATURES

- High deposition rates
- High travel speed

TYPICAL APPLICATIONS

- Heavy fabrication
- Shipbuilding
- Storage tanks
- Bridge fabrication

CONFORMANCES

AWS A5.1:	E7028-H8
ABS:	3YH10
CWB/CSA:	E4928-H8
DNV-GL:	3YH10
Lloyd's Register:	3YM H10

WELDING POSITIONS

Flat & Horizontal

DIAMETERS / PACKAGING

Diameter in (mm)	Length in (mm)	50 lb (22.7 kg) Easy Open Can
5/32 (4.0)	14 (350)	ED032636, ED034312*
3/16 (4.8)	18 (450)	ED032790, ED034313*

*Buy America Product

MECHANICAL PROPERTIES⁽¹⁾ – As Required per AWS A5.1

	Yield Strength ⁽²⁾ MPa (ksi)	Tensile Strength MPa (ksi)	Elongation %	Charpy V-Notch J (ft-lbf) @ -18°C (0°F)
Requirements - AWS E7028 H8	400 (58) min	490 (70) min	22 min	27 (20) min
Typical Results⁽³⁾ - As-Welded	450-470 (66-69)	540-560 (77-85)	27-34	84-193 (62-142)

DEPOSIT COMPOSITION⁽¹⁾ – As Required per AWS A5.1

	%C	%Mn	%Si	%P	%S	%Ni
Requirements - AWS E7028 H8	0.15 max	1.60 max	0.90 max	0.035 max	0.035 max	0.30 max
Typical Results⁽³⁾	0.03-0.06	1.17-1.51	0.44-0.77	0.007-0.014	0.004-0.008	0.02-0.04
	%Cr	%Mo	%V	%Mn + Ni + Cr + Mo + V	Diffusible Hydrogen (mL/100g weld metal)	
Requirements - AWS E7028 H8	0.20 max	0.30 max	0.08 max	1.75 max	8.0 max	
Typical Results⁽³⁾	0.02-0.05	0.01-0.03	0.02 max.	1.25-1.62	4-5	

TYPICAL OPERATING PROCEDURES

Polarity ⁽⁴⁾	Current (Amps)		
	5/32 in (4.0 mm)	3/16 in (4.8 mm)	7/32 in (5.6 mm)
DC+	125-175	185-245	220-280
AC	130-180	190-250	250-310

⁽¹⁾Typical all weld metal. ⁽²⁾Measured with 0.2% offset. ⁽³⁾See test results disclaimer ⁽⁴⁾Preferred polarity is listed first.

LINCOLN® 7018 AC

Mild Steel, Low Hydrogen · AWS E7018 H8

KEY FEATURES

- AC polarity welding
- Capable of cold re-strikes
- Low open circuit voltage operation

CONFORMANCES

AWS A5.1:	E7018 H8
ASME SFA-A5.1:	E7018 H8
CWB/CSA W48-06:	E4918-H8

WELDING POSITIONS

All, except vertical down

TYPICAL APPLICATIONS

- Tack and skip welds
- General fabrication
- Thin sections

DIAMETERS / PACKAGING

Diameter in (mm)	Length in (mm)	1 lb (0.5 kg) Plastic Tube 6 lb (2.7 kg) Master Carton	5 lb (2.3 kg) Plastic Tube 20 lb (9.1 kg) Master Carton*	50 lb (22.7 kg) Easy Open Can
3/32 (2.4)	14 (350)	ED033512*	ED033514	ED031732
1/8 (3.2)	14 (350)	ED033513*	ED033515	ED031734
5/32 (4.0)	14 (350)		ED033516	ED031738

* NOTE: Retail Small Packaging (RSP). All RSP products carry AWS compliance. Unlike the standard products, RSP products have no other agencies approvals.

MECHANICAL PROPERTIES⁽¹⁾ – As Required per AWS A5.1

	Yield Strength ⁽²⁾ MPa (ksi)	Tensile Strength MPa (ksi)	Elongation %	Charpy V-Notch J (ft-lbf) @ -29°C (-20°F)
Requirements - AWS E7018 H8	400 (58) min	490 (70) min	22 min	27 (20) min
Typical Results ⁽³⁾ - As-Welded	435-625 (63-80)	515-685 (75-90)	23-29	27-76 (20-56)

DEPOSIT COMPOSITION⁽¹⁾ – As Required per AWS A5.1

	%C	%Mn	%Si	%P	%S	%Ni
Requirements - AWS E7018 H8	0.15 max	1.60 max	0.75 max	0.035 max	0.035 max	0.30 max
Typical Results ⁽³⁾	0.04-0.07	1.00-1.60	0.32-0.63	0.01-0.02	≤ 0.01	0.01-0.03
	%Cr	%Mo	%V	%Mn + Ni + Cr + Mo + V	Diffusible Hydrogen (mL/100g weld metal)	
Requirements - AWS E7018 H8	0.20 max	0.30 max	0.08 max	1.75 max	8.0 max	
Typical Results ⁽³⁾	0.03-0.08	≤ 0.01	0.02-0.05	1.00-1.40	2-4	

TYPICAL OPERATING PROCEDURES

Polarity ⁽⁴⁾	Current (Amps)		
	3/32 in (2.4 mm)	1/8 in (3.2 mm)	5/32 in (4.0 mm)
AC	75-120	105-150	130-200
DC+	70-115	100-140	120-185

⁽¹⁾Typical all weld metal. ⁽²⁾Measured with 0.2% offset. ⁽³⁾See test results disclaimer ⁽⁴⁾Preferred polarity is listed first.

EXCALIBUR® 7018-A1 MR®

Low Alloy, Low Hydrogen · AWS E7018-A1 H4R

KEY FEATURES

- Designed for welding 0.50% molybdenum steel
- Square coating burn-off

CONFORMANCES

AWS A5.5:	E7018-A1 H4R
ABS:	E7018-A1 H4R
CWB/CSA:	E4918-A1-H4R

TYPICAL APPLICATIONS

- Applications requiring stress-relieved conditions
- Pressure vessels and pressure piping

WELDING POSITIONS

All, except vertical down

DIAMETERS / PACKAGING

Diameter in (mm)	Length in (mm)	8 lb (3.6 kg) Easy Open Can 24 lb (10.9 kg) Master Carton	10 lb (4.5 kg) Easy Open Can 30 lb (13.6 kg) Master Carton	25 lb (11.3 kg) Easy Open Can	50 lb (22.7 kg) Easy Open Can
3/32 [2.4]	12 [300]	ED032893	ED032873	ED032875	ED032876 ED032877
1/8 [3.2]	14 [350]				
5/32 [4.0]	14 [350]				

MECHANICAL PROPERTIES⁽¹⁾ – As Required per AWS A5.5

	Yield Strength ⁽²⁾ MPa (ksi)	Tensile Strength MPa (ksi)	Elongation %	Charpy V-Notch J (ft-lbf) @ -29°C (-20°F)
Requirements - AWS E7018-A1 H4R	390 [57] min	490 [70] min	22 min	Not Specified
Typical Results⁽³⁾ -				
Stress-Relieved 1 hr @ 620°C (1150°F)	470-500 [68-72]	565-585 [82-85]	25-32	60-130 [46-96]
Stress-Relieved 8 hrs @ 620°C (1150°F) ⁽⁴⁾	450-485 [65-70]	545-570 [79-83]	27-32	50-107 [38-79]

DEPOSIT COMPOSITION⁽¹⁾ – As Required per AWS A5.5

	%C	%Mn	%Si	%P
Requirements - AWS E7018-A1 H4R	0.12 max	0.90 max	0.80 max	0.03 max
Typical Results⁽³⁾	0.04-0.06	0.55-0.80	0.35-0.55	≤ 0.01
	%S	%Mo	Diffusible Hydrogen (mL/100g weld metal)	
Requirements - AWS E7018-A1 H4R	0.03 max	0.40-0.65	4.0 max	
Typical Results⁽³⁾	≤ 0.01	0.45-0.65	2-4	

TYPICAL OPERATING PROCEDURES

Polarity ⁽⁵⁾	Current (Amps)		
	3/32 in [2.4 mm]	1/8 in [3.2 mm]	5/32 in [4.0 mm]
DC+	60-110	85-160	110-210
AC	65-120	90-170	115-220

⁽¹⁾Typical all weld metal. ⁽²⁾Measured with 0.2% offset. ⁽³⁾See test results disclaimer ⁽⁴⁾Industry Specific Data (Not AWS Requirement). ⁽⁵⁾Preferred polarity is listed first.

EXCALIBUR® 8018-B2 MR®

Low Alloy, Low Hydrogen · AWS E8018-B2 H4R

KEY FEATURES

- Designed for welding 1.25% chromium, 0.50% molybdenum steel
- Premium arc performance

CONFORMANCES

AWS A5.5:	E8018-B2 H4R
ASME SFA-A5.5:	E8018-B2 H4R
CWB/CSA W48-06:	E5518-B2

TYPICAL APPLICATIONS

- Applications requiring stress-relieved conditions
- Power generation
- Chemical Processing Structure
- Process piping

WELDING POSITIONS

All, except vertical down

DIAMETERS / PACKAGING

Diameter in (mm)	Length in (mm)	8 lb (3.6 kg) Easy Open Can 24 lb (10.9 kg) Master Carton	10 lb (4.5 kg) Easy Open Can 30 lb (13.6 kg) Master Carton	25 lb (11.3 kg) Easy Open Can	50 lb (22.7 kg) Easy Open Can
3/32 (2.4)	12 (300)	ED032878	ED032879	ED032881	ED032882 ED032883
1/8 (3.2)	14 (350)				
5/32 (4.0)	14 (350)				

MECHANICAL PROPERTIES⁽¹⁾ – As Required per AWS A5.5

	Yield Strength ⁽²⁾ MPa [ksi]	Tensile Strength MPa [ksi]	Elongation %	Charpy V-Notch J [ft-lbf] @ -29°C [-20°F]
Requirements - AWS E8018-B2 H4R	460 (67) min	550 (80) min	19 min	Not Specified
Typical Results⁽³⁾				
Stress-Relieved 1 hr @ 690°C (1275°F)	540-585 (78-85)	640-685 (93-99)	24-26	71-127 (52-94)
Stress-Relieved 8 hrs @ 690°C (1275°F) ⁽⁴⁾	495-540 (72-78)	605-640 (88-93)	25-28	64-127 (47-83)

DEPOSIT COMPOSITION⁽¹⁾ – As Required per AWS A5.5

	%C	%Mn	%Si	%P
Requirements - AWS E8018-B2 H4R	0.05-0.12	0.90 max	0.80 max	0.03 max
Typical Results⁽³⁾	0.08-0.11	0.65-0.80	0.35-0.55	≤ 0.02
	%S	%Cr	%Mo	Diffusible Hydrogen (mL/100g weld metal)
Requirements - AWS E8018-B2 H4R	0.03 max	1.00-1.50	0.40-0.65	4.0 max
Typical Results⁽³⁾	≤ 0.01	1.05-1.30	0.40-0.60	2-4

TYPICAL OPERATING PROCEDURES

Polarity ⁽⁵⁾	Current (Amps)		
	3/32 in (2.4 mm)	1/8 in (3.2 mm)	5/32 in (4.0 mm)
DC+	60-110	85-160	110-210
AC	65-120	90-170	115-220

⁽¹⁾Typical all weld metal. ⁽²⁾Measured with 0.2% offset. ⁽³⁾See test results disclaimer. ⁽⁴⁾Industry Specific Data (Not AWS Requirement). ⁽⁵⁾Preferred polarity is listed first.

EXCALIBUR® 8018-C1 MR®

Low Alloy, Low Hydrogen · AWS E8018-C1 H4R

KEY FEATURES

- Designed to produce a nominal 2.25% nickel deposit

CONFORMANCES

AWS A5.5: E8018-C1 H4R
CWB/CSA: E5518-C1-H4

TYPICAL APPLICATIONS

- Low temperature applications
- Refrigerated ammonia tanks
- Liquefied gas storage, piping and transportation
- Weathering steels
- Applications requiring stress-relieved conditions

WELDING POSITIONS

All, except vertical down

DIAMETERS / PACKAGING

Diameter in (mm)	Length in (mm)	10 lb (4.5 kg) Easy Open Can 30 lb (13.6 kg) Master Carton	50 lb (22.7 kg) Easy Open Can
3/32 (2.4)	14 (350)	ED032596	ED030876
1/8 (3.2)	14 (350)	ED032597	ED030877
5/32 (4.0)	14 (350)		ED030878
3/16 (4.8)	14 (350)		ED030879

MECHANICAL PROPERTIES⁽¹⁾ – As Required per AWS A5.5

	Yield Strength ⁽²⁾ MPa (ksi)	Tensile Strength MPa (ksi)	Elongation %	Charpy V-Notch J (ft-lbf) @ -59°C (-75°F)
Requirements - AWS E8018-C1 H4R	460 (67) min	550 (80) min	19 min	20 (27) min
Typical Results⁽³⁾ Stress-Relieved 1 hr @ 610°C (1125°F)	460-525 (67-76)	565-615 (82-89)	24-32	79-129 (58-95)

DEPOSIT COMPOSITION⁽¹⁾ – As Required per AWS A5.5

	%C	%Mn	%Si	%P
Requirements - AWS E8018-C1 H4R	0.12 max	1.25 max	0.80 max	0.03 max
Typical Results⁽³⁾ - As-Welded	0.05-0.09	0.89-1.25	0.17-0.53	≤ 0.02
	%S	%Ni	Diffusible Hydrogen (mL/100g weld deposit)	
Requirements - AWS E8018-C1 H4R	0.03 max	2.00-2.75	4.0 max	
Typical Results⁽³⁾ - As-Welded	≤ 0.01	2.00-2.58	1-3	

TYPICAL OPERATING PROCEDURES

Polarity ⁽⁴⁾	Current (Amps)					
	3/32 in (2.4 mm)	1/8 in (3.2 mm)	5/32 in (4.0 mm)	3/16 in (4.8 mm)	7/32 in (5.6 mm)	1/4 in (6.4 mm)
DC+	70-110	90-160	130-210	180-300	250-330	300-400
AC	80-120	100-160	140-210	200-300	270-370	325-430

⁽¹⁾Typical all weld metal. ⁽²⁾Measured with 0.2% offset. ⁽³⁾See test results disclaimer ⁽⁴⁾Preferred polarity is listed first.

EXCALIBUR® 8018-C3 MR®

Low Alloy, Low Hydrogen · AWS E8018-C3 H4R



KEY FEATURES

- Designed to produce a 1% nickel deposit
- Premium arc performance
- Meets NACE MR0175 for sour gas applications
- Test data available for SSC (NACE TM0177) & HIC (NACE TM0284)

TYPICAL APPLICATIONS

- Cross country pipe repair
- Piping and gas storage tanks
- Weathering steels

CONFORMANCES

AWS A5.5:	E8018-C3 H4R
ABS:	E8018-C3 H4R
CWB/CSA:	E5518-C3-H4
ISO 2560-B:	E5518-N2 A U H5

WELDING POSITIONS

All, except vertical down

DIAMETERS / PACKAGING

Diameter in (mm)	Length in (mm)	10 lb (4.5 kg) Easy Open Can 30 lb (13.6 kg) Master Carton	50 lb (22.7 kg) Easy Open Can
3/32 (2.4)	14 (350)	ED032599	ED030892, ED034039*
1/8 (3.2)	14 (350)	ED032600	ED030893, ED034040*
5/32 (4.0)	14 (350)		ED030894, ED034041*
3/16 (4.8)	14 (350)		ED030895, ED034042*
7/32 (5.6)	18 (450)		ED030897, ED034315*

*Buy America Product

MECHANICAL PROPERTIES⁽¹⁾ – As Required per AWS A5.5

	Yield Strength ⁽²⁾ MPa (ksi)	Tensile Strength MPa (ksi)	Elongation %	Charpy V-Notch J (ft-lbf) @ -40°C (-40°F)
Requirements - AWS E8018-C3 H4R	470-550 (68-80)	550 (80) min	24 min	27 (20) min
Typical Results⁽³⁾ - As-Welded	505-590 (73-86)	550-675 (80-98)	24-32	81-163 (60-120)

DEPOSIT COMPOSITION⁽¹⁾ – As Required per AWS A5.5

	%C	%Mn	%Si	%P	%S
Requirements - AWS E8018-C3 H4R	0.12 max.	0.40-1.25	0.80 max.	0.03 max	0.03 max
Typical Results⁽³⁾	0.04-0.07	0.40-1.25	0.23-0.46	≤ 0.01	≤ 0.009
	%Ni	%Cr	%Mo	%V	Diffusible Hydrogen (mL/100g weld deposit)
Requirements - AWS E8018-C3 H4R	0.80-1.10	0.15 max	0.35 max	0.05 max	4.0 max
Typical Results⁽³⁾	0.81-1.09	0.04-0.06	0.07-0.27	≤ 0.01	1-2

TYPICAL OPERATING PROCEDURES

Polarity ⁽⁴⁾	Current (Amps)					
	3/32 in (2.4 mm)	1/8 in (3.2 mm)	5/32 in (4.0 mm)	3/16 in (4.8 mm)	7/32 in (5.6 mm)	1/4 in (6.4 mm)
DC±	70-110	90-160	130-210	180-300	250-330	300-400
AC	80-120	100-160	140-210	200-300	270-370	325-425

⁽¹⁾Typical all weld metal. ⁽²⁾Measured with 0.2% offset. ⁽³⁾See test results disclaimer ⁽⁴⁾Preferred polarity is listed first.

EXCALIBUR® 9018M MR®

Low Alloy, Low Hydrogen · AWS E9018M H4R

KEY FEATURES

- Designed to produce weld deposits with 620 MPa (90 ksi) tensile strength

TYPICAL APPLICATIONS

- High strength steel, such as HY-80, HY-90 and ASTM A514
- Cross country pipe repair
- DC welding

CONFORMANCES

AWS A5.5:	E9018M H4R
ABS:	E9018M H4R
CWB/CSA:	E6218M-H4R

WELDING POSITIONS

All, except vertical down

DIAMETERS / PACKAGING

Diameter in (mm)	Length in (mm)	10 lb (4.5 kg) Easy Open Can 30 lb (13.6 kg) Master Carton	50 lb (22.7 kg) Easy Open Can
3/32 (2.4)	14 (350)	ED032602	ED030868
1/8 (3.2)	14 (350)	ED032603	ED030869
5/32 (4.0)	14 (350)		ED030870
3/16 (4.8)	14 (350)		ED030871

MECHANICAL PROPERTIES⁽¹⁾ – As Required per AWS A5.5

	Yield Strength ⁽²⁾ MPa (ksi)	Tensile Strength MPa (ksi)	Elongation %	Charpy V-Notch J (ft-lbf) @ -50°C (-60°F)
Requirements - AWS E9018M H4R	540-620 (78-90) min	620 (90) min	24 min	27 (20) min
Typical Results ⁽³⁾ - As-Welded	540-620 (78-90)	620-705 (90-102)	24-37	27-122 (20-90)

DEPOSIT COMPOSITION⁽¹⁾ – As Required per AWS A5.5

	%C	%Mn	%Si	%P	%S
Requirements - AWS E9018M H4R	0.10 max	0.60-1.25	0.80 max	0.03 max	0.03 max.
Typical Results ⁽³⁾	0.04-0.07	0.90-1.10	0.30-0.50	0.01-0.02	≤ 0.01
	%Ni	%Cr	%Mo	Diffusible Hydrogen (mL/100g weld deposit)	
Requirements - AWS E9018M H4R	1.40-1.80	0.15 max	0.35 max	4.0 max	
Typical Results ⁽³⁾	1.50-1.80	0.05-0.12	0.25-0.35	1-3	

TYPICAL OPERATING PROCEDURES

Polarity	Current (Amps)			
	3/32 in (2.4 mm)	1/8 in (3.2 mm)	5/32 in (4.0 mm)	3/16 in (4.8 mm)
DC+	70-110	90-160	130-210	180-300

⁽¹⁾Typical all weld metal. ⁽²⁾Measured with 0.2% offset. ⁽³⁾See test results disclaimer

EXCALIBUR® 10018-D2 MR®

Low Alloy, Low Hydrogen · AWS E10018-D2 H4R

KEY FEATURES

- Premium arc performance
- Q2 Lot® - Lot Controlled Chemistry and Mechanical Properties
- Easy strike and slag removal

TYPICAL APPLICATIONS

- Offshore and subsea components
- Meets NACE MR0175/ISO15156-2
- Chromium-molybdenum and other low alloy steels, including AISI 4130, 4140, 8630 and ASTM A182 and A336 Grades F22
- Carbon-manganese and other low alloy steels
- Process piping

CONFORMANCES

AWS A5.5:	E10018-D2 H4R
ABS:	3YQ620 H5
CWB/CSA:	E6918-D2
DNV-GL:	3 Y62H5
Lloyd's Register:	3Y62M H5

WELDING POSITIONS

All, except vertical down

DIAMETERS / PACKAGING

Diameter in (mm)	Length in (mm)	25 lb (11.3 kg) Easy Open Can	50 lb (22.7 kg) Easy Open Can
3/32 (2.4)	12 (300)	ED033162	ED033163
1/8 (3.2)	14 (350)		
5/32 (4.0)	14 (350)		
3/16 (4.8)	14 (350)		
7/32 (5.6)	18 (450)		

MECHANICAL PROPERTIES⁽¹⁾ – As Required per AWS A5.5

	Yield Strength ⁽²⁾ MPa (ksi)	Tensile Strength MPa (ksi)	Elongation %	Charpy V-Notch J (ft-lbf) @ -51°C (-60°F)	Hardness ⁽⁴⁾ HV ₁₀
Requirements - AWS E10018-D2 H4R	600 (87) min	690 (100) min	16 min	27 (20) min	Not Specified
Typical Results⁽³⁾ - Stress-Relieved 1 hr @ 620°C (1150°F)	650-715 (94-104)	725-780 (105-113)	22-25	56-69 (41-51)	219-242
Welded on AISI 4130 Steel					
Typical Results⁽³⁾ - Stress-Relieved 12 hrs @ 620°C (1150°F) ⁽⁴⁾	560-580 (81-84)	650-675 (94-98)	24-25	47-68 (35-50)	210-214

DEPOSIT COMPOSITION⁽¹⁾ – As Required per AWS A5.5

	%C	%Mn	%Si	%P
Requirements - AWS E10018-D2 H4R	0.15 max	1.65-2.00	0.80 max	0.03 max
Typical Results⁽³⁾	0.08-0.12	1.69-1.91	0.35-0.49	0.01-0.02
	%S	%Ni	%Mo	Diffusible Hydrogen (mL/100g weld deposit)
Requirements - AWS E10018-D2 H4R	0.03 max	0.90 max	0.25-0.45	4.0 max
Typical Results⁽³⁾	≤0.01	0.68-0.77	0.34-0.39	2-3

TYPICAL OPERATING PROCEDURES

Polarity	Current (Amps)		
	3/32 in (2.4 mm)	1/8 in (3.2 mm)	5/32 in (4.0 mm)
DC+	60-110	85-160	110-210
AC	65-120	90-170	115-220

⁽¹⁾Typical all weld metal. ⁽²⁾Measured with 0.2% offset. ⁽³⁾See test results disclaimer ⁽⁴⁾Industry specific data, not required by AWS. ⁽⁵⁾Preferred polarity is listed first.
NOTE: Additional test data available upon request.

EXCALIBUR® 11018M MR®

Low Alloy, Low Hydrogen · AWS E11018M H4R

KEY FEATURES

- Square coating burn-off

TYPICAL APPLICATIONS

- Quenched and tempered steels, such as A514, A517 and A709
- General fabrication of high strength steels
- Crane booms
- Trailer frames

CONFORMANCES

AWS A5.5:	E11018M-H4R
ABS - Part 2:	4YQ690 H5
CWB/CSA:	E11018M-H4R
DNV-GL:	4 YM69H5

WELDING POSITIONS

All, except vertical down

DIAMETERS / PACKAGING

Diameter in (mm)	Length in (mm)	10 lb (4.5 kg) Easy Open Can 30 lb (13.6 kg) Master Carton	50 lb (22.7 kg) Easy Open Can
3/32 (2.4)	14 (350)		ED031975
1/8 (3.2)	14 (350)	ED032607	ED031976
5/32 (4.0)	14 (350)	ED032608	ED031977
3/16 (4.8)	14 (350)		ED031978

MECHANICAL PROPERTIES⁽¹⁾ – As Required per AWS A5.5

	Yield Strength ⁽²⁾ MPa (ksi)	Tensile Strength MPa (ksi)	Elongation %	Charpy V-Notch J (ft-lbf) @ -50°C (-60°F)
Requirements - AWS E11018M H4R	680-760 (98-110)	760 (110) min	20 min	27 (20) min
Typical Results ⁽³⁾ - As-Welded	690-758 (100-110)	765-807 (111-117)	20-26	76-103 (56-76)

DEPOSIT COMPOSITION⁽¹⁾ – As Required per AWS A5.5

	%C	%Mn	%Si	%P	%S
Requirements - AWS E11018M H4R	0.10 max	1.30-1.80	0.60 max	0.03 max	0.03 max
Typical Results ⁽³⁾	0.04-0.05	1.55-1.80	0.40-0.55	≤ 0.02	0.01-0.03
	%Ni	%Cr	%Mo	Diffusible Hydrogen (mL/100g weld deposit)	
Requirements - AWS E11018M H4R	1.25-2.50	0.40 max	0.25-0.50	4.0 max	
Typical Results ⁽³⁾	2.0-2.5	0.02-0.20	0.40-0.50	1-4	

TYPICAL OPERATING PROCEDURES

Polarity	Current (Amps)			
	3/32 in (2.4 mm)	1/8 in (3.2 mm)	5/32 in (4.0 mm)	3/16 in (4.8 mm)
DC+	70-110	90-160	130-210	180-300

⁽¹⁾Typical all weld metal. ⁽²⁾Measured with 0.2% offset. ⁽³⁾See test results disclaimer

FLEETWELD® 5P+®

Mild Steel, Cellulosic · AWS E6010

KEY FEATURES

- High operator appeal and control
- Easy slag removal

TYPICAL APPLICATIONS

- Standard in the pipe welding industry for root pass C
- cross country and in-plant pipe welding
- Steel with moderate surface contaminants
- Repair welding

CONFORMANCES

AWS A5.1:	E6010
ABS:	E6010
CWB/CSA:	E4310
DV:	3
ISO 2560-A	E 42.3 C 25

WELDING POSITIONS

All

DIAMETERS / PACKAGING

Diameter in (mm)	Length in (mm)	10 lb (4.5 kg) Easy Open Can 30 lb (13.6 kg) Master Carton	50 lb (22.7kg) Easy Open Can
3/32 [2.4]	12 [300]	ED032564	ED010283
1/8 [3.2]	14 [350]	ED032565	ED010278
5/32 [4.0]	14 [350]	ED032566	ED010285
3/16 [4.8]	14 [350]		ED010281

MECHANICAL PROPERTIES⁽¹⁾ – As Required per AWS A5.1

	Yield Strength ⁽²⁾ MPa (ksi)	Tensile Strength MPa (ksi)	Elongation %	Charpy V-Notch J (ft-lbf) @-29°C (-20°F)
Requirements - AWS E6010	330 (48) min	430 (60) min	22 min	27 (20) min
Typical Results ⁽³⁾ - As-Welded	415-500 (60-73)	500-610 (73-88)	22-29	51-93 (38-69)

DEPOSIT COMPOSITION⁽¹⁾ – As Required per AWS A5.1

	%C	%Mn	%Si	%P	%S
Requirements - AWS E6010	0.20 max	1.20 max	1.00 max	Not Specified	Not Specified
Typical Results ⁽³⁾ - As-Welded	0.09-0.20	0.46-0.79	0.10-0.32	0.005-0.017	0.004-0.014
	%Ni	%Cr	%Mo	%V	
Requirements - AWS E6010	0.30 max	0.20 max	0.30 max	0.08 max	
Typical Results ⁽³⁾ - As-Welded	≤ 0.04	≤ 0.04	≤ 0.02	≤ 0.01	

TYPICAL OPERATING PROCEDURES

Polarity ⁽⁴⁾	Current (Amps)			
	3/32 in (2.4 mm)	1/8 in (3.2 mm)	5/32 in (4.0 mm)	3/16 in (4.8 mm)
DC+	50-85	75-135	100-175	140-225
DC-	50-85	75-135	100-175	–

⁽¹⁾Typical all weld metal. ⁽²⁾Measured with 0.2% offset. ⁽³⁾See test results disclaimer ⁽⁴⁾Preferred polarity is listed first.

FLEETWELD® 5P®

Mild Steel, Cellulosic · AWS E6010

KEY FEATURES

- Deep arc penetration
- Light slag with minimal arc interference
- Excellent vertical and overhead capability

TYPICAL APPLICATIONS

- Welding on galvanized and specially coated steels
- Steel with moderate surface contaminants
- Square edge butt welds

CONFORMANCES

AWS A5.1:	E6010
ABS:	E6010
CWB/CSA:	E4310
Lloyd's Register:	3M

WELDING POSITIONS

All

DIAMETERS / PACKAGING

Diameter in (mm)	Length in (mm)	5 lb (2.3 kg) Plastic Tube 20 lb (9.1 kg) Master Carton*	10 lb (4.5 kg) Easy Open Can 30 lb (13.6 kg) Master Carton	50 lb (22.7kg) Easy Open Can
3/32 (2.4)	12 (300)	ED033509	ED032561	ED010211
1/8 (3.2)	14 (350)	ED033510	ED032562	ED010203
5/32 (4.0)	14 (350)	ED033511	ED032563	ED010216
3/16 (4.8)	14 (350)			ED010207
7/32 (5.6)	14 (350)			ED010219

* NOTE: Retail Small Packaging (RSP). All RSP products carry AWS compliance. Unlike the standard products, RSP products have no other agencies approvals.

MECHANICAL PROPERTIES⁽¹⁾ – As Required per AWS A5.1

	Yield Strength ⁽²⁾ MPa (ksi)	Tensile Strength MPa (ksi)	Elongation %	Charpy V-Notch J (ft-lbf) @-29°C (-20°F)
Requirements - AWS E6010	330 (48) min	430 (60) min	22 min	27 (20) min
Typical Results ⁽³⁾ - As-Welded	420-475 (61-69)	515-570 (75-83)	25-31	41-68 (30-50)

DEPOSIT COMPOSITION⁽¹⁾ – As Required per AWS A5.1

	%C	%Mn	%Si	%P	%S
Requirements - AWS E6010	0.20 max	1.20 max	1.00 max	Not Specified	Not Specified
Typical Results ⁽³⁾ - As-Welded	0.09-0.17	0.40-0.63	0.09-0.43	0.005-0.017	0.005-0.014
	%Ni	%Cr	%Mo	%V	
Requirements - AWS E6010	0.30 max	0.20 max	0.30 max	0.08 max	
Typical Results ⁽³⁾ - As-Welded	0.01-0.05	0.01-0.05	≤ 0.03	≤ 0.01	

TYPICAL OPERATING PROCEDURES

Polarity ⁽⁴⁾	Current (Amps)					
	3/32 in (2.4 mm)	1/8 in (3.2 mm)	5/32 in (4.0 mm)	3/16 in (4.8 mm)	7/32 in (5.6 mm)	1/4 in (6.4 mm)
DC+	40-80	70-130	90-165	140-225	200-275	220-325
DC-	50-85	75-135	100-175	–	–	–

⁽¹⁾Typical all weld metal. ⁽²⁾Measured with 0.2% offset. ⁽³⁾See test results disclaimer ⁽⁴⁾Preferred polarity is listed first.

FLEETWELD® 35

Mild Steel, Cellulosic · AWS E6011

KEY FEATURES

- Stable arc performance
- High operator appeal
- AC and DC welding

CONFORMANCES

AWS A5: E6011
 ABS: E6011
 Lloyd's Register: 3M

TYPICAL APPLICATIONS

- Welding on galvanized and specially coated steels
- Steel with moderate surface contaminants
- Sheet metal
- In-plant pipe welding

WELDING POSITIONS

All

DIAMETERS / PACKAGING

Diameter in (mm)	Length in (mm)	50 lb (22.7 kg) Easy Open Can
3/32 (2.4)	14 (350)	ED028152
1/8 (3.2)	14 (350)	ED028153
5/32 (4.0)	14 (350)	ED028154
3/16 (4.8)	14 (350)	ED028155
7/32 (5.6)	18 (450)	ED032301
1/4 (6.4)	18 (450)	ED028157

MECHANICAL PROPERTIES⁽¹⁾ – As Required per AWS A5.1

	Yield Strength ⁽²⁾ MPa (ksi)	Tensile Strength MPa (ksi)	Elongation %	Charpy V-Notch J (ft-lbf) @ -29°C (-20°F)
Requirements - AWS E6011	330 (48) min	430 (60) min	22 min	27 (20) min
Typical Results ⁽³⁾ - As-Welded	385-415 (56-60)	470-510 (68-74)	26-33	56-101 (42-75)

DEPOSIT COMPOSITION⁽¹⁾ – As Required per AWS A5.1

	%C	%Mn	%Si	%P	%S
Requirements - AWS E6011	0.20 max	1.20 max	1.00 max	Not Specified	Not Specified
Typical Results ⁽³⁾ - As-Welded	0.11-0.16	0.32-0.60	0.09-0.28	0.006-0.011	0.004-0.013
	%Ni	%Cr	%Mo	%V	
Requirements - AWS E6011	0.30 max	0.20 max	0.30 max	0.08 max	
Typical Results ⁽³⁾ - As-Welded	≤ 0.06	0.01-0.04	≤ 0.02	≤ 0.01	

TYPICAL OPERATING PROCEDURES

Polarity ⁽⁴⁾	Current (Amps)					
	3/32 in (2.4 mm)	1/8 in (3.2 mm)	5/32 in (4.0 mm)	3/16 in (4.8 mm)	7/32 in (5.6 mm)	1/4 in (6.4 mm)
AC	50-85	75-120	90-160	120-200	150-260	190-300
DC±	40-75	70-110	80-145	110-180	135-235	170-270

⁽¹⁾Typical all weld metal. ⁽²⁾Measured with 0.2% offset. ⁽³⁾See test results disclaimer. ⁽⁴⁾Preferred polarity is listed first.

FLEETWELD® 180

Mild Steel, Cellulosic · AWS E6011

KEY FEATURES

- Easy to strike arc
- AC polarity welding

CONFORMANCES

AWS A5.1:	E6011
CWB/CSA:	E4311

TYPICAL APPLICATIONS

- Performs on low amperages and OCV
- Sheet metal
- Edge, corner and butt joints

WELDING POSITIONS

All

DIAMETERS / PACKAGING

Diameter in (mm)	Length in (mm)	1 lb (0.5 kg) Plastic Tube 6 lb (2.7 kg) Master Carton	5 lb (2.3 kg) Plastic Tube 20 lb (9.1 kg) Master Carton*	50 lb (22.7 kg) Easy Open Can
3/32 (2.4)	12 (300)	ED033494*	ED033496	ED010110
1/8 (3.2)	14 (350)	ED033495*	ED033497	ED010105
5/32 (4.0)	14 (350)			ED010114

* NOTE: Retail Small Packaging (RSP). All RSP products carry AWS compliance. Unlike the standard products, RSP products have no other agencies approvals.

MECHANICAL PROPERTIES⁽¹⁾ – As Required per AWS A5.1

	Yield Strength ⁽²⁾ MPa (ksi)	Tensile Strength MPa (ksi)	Elongation %	Charpy V-Notch J (ft-lbf) @-29°C (-20°F)
Requirements - AWS E6011	330 (48) min	430 (60) min	22 min	27 (20) min
Typical Results ⁽³⁾ - As-Welded	460-490 (67-71)	570-590 (83-86)	22-32	35-72 (26-53)

DEPOSIT COMPOSITION⁽¹⁾ – As Required per AWS A5.1

	%C	%Mn	%Si	%P	%S
Requirements - AWS E6011	0.20 max	1.20 max	1.00 max	Not Specified	Not Specified
Typical Results ⁽³⁾ - As-Welded	0.13-0.20	0.44-0.71	0.23-0.45	0.009-0.014	0.005-0.008
	%Ni	%Cr	%Mo	%V	
Requirements - AWS E6011	0.30 max	0.20 max	0.30 max	0.08 max	
Typical Results ⁽³⁾ - As-Welded	≤ 0.03	≤ 0.03	≤ 0.01	≤ 0.01	

TYPICAL OPERATING PROCEDURES

Polarity ⁽⁴⁾	Current (Amps)		
	3/32 in (2.4 mm)	1/8 in (3.2 mm)	5/32 in (4.0 mm)
AC	40-90	65-120	115-150
DC±	40-80	60-110	105-135

⁽¹⁾Typical all weld metal. ⁽²⁾Measured with 0.2% offset. ⁽³⁾See test results disclaimer ⁽⁴⁾Preferred polarity is listed first.

MUREX® 6011C

Mild Steel, Cellulosic · AWS E6011

KEY FEATURES

- Deep penetration and fast freezing
- Fast travel speed and flatter contour fillets deliver

CONFORMANCES

AWS A5.1:	E6011
ASME SFA-5.1:	E6011
ABS:	E6011

TYPICAL APPLICATIONS

- Small AC welders welding on galvanized steel
- Automobile frames, storage tanks and piping
- Rusty or oily steel in maintenance and repair work

WELDING POSITIONS

All

DIAMETERS / PACKAGING

Diameter in (mm)	50 lb (22.7 kg) Carton
3/32 [2.4]	EDM13182343
1/8 [3.2]	EDM13182304
5/32 [4.0]	EDM13182305
3/16 [4.8]	EDM13182306

MECHANICAL PROPERTIES⁽¹⁾ – As Required per AWS A5.1

	Yield Strength ⁽²⁾ MPa (ksi)	Tensile Strength MPa (ksi)	Elongation %	Charpy V-Notch J (ft-lbf) @-20°C [-29°F]
Requirements - AWS E6011	48,000 [330] min	60,000 [410] min	22 min	20 [27] min
Typical Results ⁽³⁾ - As-Welded	57,000-75,000 [393-517]	66,000-86,000 [455-593]	22-35	22-93 [30-126]

DEPOSIT COMPOSITION⁽¹⁾ – As Required per AWS A5.1

	%C	%Mn	%Si	%P	%S
Requirements - AWS E6011	0.20 max	1.20 max	1.00 max	Not Specified	Not Specified
Typical Results ⁽³⁾ - As-Welded	0.10-0.16	0.44-0.72	0.10-0.31	0.01-0.02	0.005-0.015
	%Ni	%Cr	%Mo	%V	%Mn + Ni + Cr + Mo + V
Requirements - AWS E6011	0.30 max	0.20 max	0.30 max	0.08 max	Not Specified
Typical Results ⁽³⁾ - As-Welded	0.01-0.06	0.01-0.06	0.01-0.06	0.01-0.02	0.48-0.88

TYPICAL OPERATING PROCEDURES

Polarity ⁽⁴⁾	Current (Amps)			
	3/32 in (2.4 mm)	1/8 in (3.2 mm)	5/32 in (4.0 mm)	3/16 in (4.8 mm)
AC	50-90	80-130	120-180	140-220

⁽¹⁾Typical all weld metal. ⁽²⁾Measured with 0.2% offset. ⁽³⁾See test results disclaimer

FLEETWELD® 22

Mild Steel, Rutile · AWS E6022

KEY FEATURES

- Optimized for burn-through spot welding
- Deep penetration
- Little slag interference in arc

TYPICAL APPLICATIONS

- Spot welding floor decking to beams
- Steel with moderate surface contaminants

CONFORMANCES

AWS A5.1: E6022

WELDING POSITIONS

Flat & Horizontal

DIAMETERS / PACKAGING

Diameter in (mm)	Length in (mm)	50 lb (22.7 kg) Easy Open Can
1/8 (3.2)	14 (350)	ED021896
5/32 (4.0)	14 (350)	ED021895

MECHANICAL PROPERTIES⁽¹⁾ – As Required per AWS A5.1

	Tensile Strength MPa (ksi)	Longitudinal Bend Test
Requirements - AWS E6022	430 (60) min	Required
Typical Results ⁽²⁾ - As-Welded	415-565 (60-82)	Pass

TYPICAL OPERATING PROCEDURES

Polarity ⁽⁴⁾	Current (Amps)	
	1/8 in (3.2 mm)	5/32 in (4.0 mm)
AC	110-150	150-180
DC-	110-150	150-180

⁽¹⁾Typical all weld metal. ⁽²⁾Measured with 0.2% offset. ⁽³⁾See test results disclaimer. ⁽⁴⁾Preferred polarity is listed first.

FLEETWELD® 37

Mild Steel, Rutile · AWS E6013

KEY FEATURES

- Operable with low amperages on sheet metal
- Excellent bead appearance
- Slag control accommodates vertical down welding

CONFORMANCES

AWS A5.1:	E6013
ABS:	E6013
CWB/CSA:	E4313

TYPICAL APPLICATIONS

- Maintenance or repair welding
- For use with small AC welders with low OCV
- Sheet metal
- Irregular short welds that change positions

WELDING POSITIONS

All

DIAMETERS / PACKAGING

Diameter in (mm)	Length in (mm)	1 lb (0.5 kg) Plastic Tube 6 lb (2.7 kg) Master Carton	5 lb (2.3 kg) Plastic Tube 20 lb (9.1 kg) Master Carton*	50 lb (22.7 kg) Easy Open Can
5/64 [2.0]	12 [300]			ED010170
3/32 [2.4]	12 [300]	ED033499*	ED033501	ED010161
1/8 [3.2]	14 [350]	ED033500*	ED033502	ED010153
5/32 [4.0]	14 [350]		ED033503	ED010165
3/16 [4.8]	14 [350]			ED010156

* NOTE: Retail Small Packaging (RSP). All RSP products carry AWS compliance. Unlike the standard products, RSP products have no other agencies approvals.

MECHANICAL PROPERTIES⁽¹⁾ – As Required per AWS A5.1

	Yield Strength ⁽²⁾ MPa (ksi)	Tensile Strength MPa (ksi)	Elongation %	Charpy V-Notch J [ft-lbf] @-29°C [-20°F]
Requirements - AWS E6013	330 (48) min	430 (60) min	17 min	Not Specified
Typical Results ⁽³⁾ - As-Welded	400-440 [58-64]	460-515 [67-75]	23	37-76 [27-56]

DEPOSIT COMPOSITION⁽¹⁾ – As Required per AWS A5.1

	%C	%Mn	%Si	%P	%S
Requirements - AWS E6013	0.20 max	1.20 max	1.00 max	Not Specified	Not Specified
Typical Results ⁽³⁾ - As-Welded	0.04-0.07	0.32-0.45	0.16-0.24	0.01-0.02	0.01-0.02
	%Ni	%Cr	%Mo	%V	
Requirements - AWS E6013	0.30 max	0.20 max	0.30 max	0.08 max	
Typical Results ⁽³⁾ - As-Welded	≤ 0.07	0.02 - 0.04	≤ 0.02	0.01-0.02	

TYPICAL OPERATING PROCEDURES

Polarity ⁽⁴⁾	Current (Amps)				
	5/64 in [2.0 mm]	3/32 in [2.4 mm]	1/8 in [3.2 mm]	5/32 in [4.0 mm]	3/16 in [4.8 mm]
AC	50-80	75-115	110-140	160-200	205-260
DC±	45-75	70-105	100-135	145-180	185-235

⁽¹⁾Typical all weld metal. ⁽²⁾Measured with 0.2% offset. ⁽³⁾See test results disclaimer ⁽⁴⁾Preferred polarity is listed first.

FLEETWELD® 47

Mild Steel, Rutile · AWS E7014

KEY FEATURES

- Operates on low amperages
- High deposition rates
- Excellent operator appeal

CONFORMANCES

AWS A5.1:	E7014
ABS:	E7014
CWB/CSA:	E4914

TYPICAL APPLICATIONS

- Maintenance and repair welding
- Sheet metal and fillet welds
- Heavy sections

WELDING POSITIONS

All

DIAMETERS / PACKAGING

Diameter in (mm)	Length in (mm)	1 lb (0.5 kg) Plastic Tube 6 lb (2.7 kg) Master Carton	5 lb (2.3 kg) Plastic Tube 20 lb (9.1 kg) Master Carton*	50 lb (22.7kg) Carton
3/32 (2.4)	14 (350)	ED033504*	ED033506	ED010189
1/8 (3.2)	14 (350)	ED033505*	ED033507	ED010183
5/32 (4.0)	14 (350)		ED033508	ED010193
3/16 (4.8)	14 (350)			ED010186

* NOTE: Retail Small Packaging (RSP). All RSP products carry AWS compliance. Unlike the standard products, RSP products have no other agencies approvals.

MECHANICAL PROPERTIES⁽¹⁾ – As Required per AWS A5.1

	Yield Strength ⁽²⁾ MPa (ksi)	Tensile Strength MPa (ksi)	Elongation %	Charpy V-Notch J (ft-lbf) @ -29°C [-20°F]
Requirements - AWS E7014	400 (58) min	490 (70) min	17 min	Not Specified
Typical Results⁽³⁾ - As-Welded	400-510 (58-74)	490-585 (70-85)	23-29	45-103 (33-76)

DEPOSIT COMPOSITION⁽¹⁾ – As Required per AWS A5.1

	%C	%Mn	%Si	%P	%S
Requirements - AWS E7014	0.15 max	1.25 max	0.90 max	0.035 max	0.035 max
Typical Results⁽³⁾ - As-Welded	0.06-0.10	0.25-0.67	0.04-0.69	0.01-0.02	≤ 0.02
	%Ni	%Cr	%Mo	%V	%Mn + Ni + Cr + Mo + V
Requirements - AWS E7014	0.30 max	0.20 max	0.30 max	0.08 max	1.50 max
Typical Results⁽³⁾ - As-Welded	0.02-0.09	0.01-0.05	≤ 0.02	≤ 0.02	0.37

TYPICAL OPERATING PROCEDURES

Polarity ⁽⁴⁾	Current (Amps)			
	3/32 in (2.4 mm)	1/8 in (3.2 mm)	5/32 in (4.0 mm)	3/16 in (4.8 mm)
AC	80-100	110-155	150-225	200-285
DC±	75-95	100-145	135-200	185-235

⁽¹⁾Typical all weld metal. ⁽²⁾Measured with 0.2% offset. ⁽³⁾See test results disclaimer. ⁽⁴⁾Preferred polarity is listed first.

MUREX[®] 6013D

Mild Steel, Rutile · AWS E6013

KEY FEATURES

- Excellent wetting action, yielding smooth and flat beads
- AC or DC polarity
- Low spatter and excellent slag removal – virtually self cleaning on vertical down fillets

TYPICAL APPLICATIONS

- Good choice when shallow penetration is required or fit up is poor
- Sheet metal
- Maintenance and repair welding

CONFORMANCES

AWS A5.1: E6013

ASME SFA-5.1: E6013

WELDING POSITIONS

All, Ideal for vertical down welding

DIAMETERS / PACKAGING

Diameter in (mm)	50 lb (22.7 kg) Carton
3/32 (2.4)	EDM13182463
1/8 (3.2)	EDM13182454
5/32 (4.0)	EDM13182455

MECHANICAL PROPERTIES⁽¹⁾ – As Required per AWS A5.1

	Yield Strength ⁽²⁾ MPa (ksi)	Tensile Strength MPa (ksi)	Elongation %	Charpy V-Notch J (ft·lbf) @-20°C (-29°F)
Requirements - AWS E6013	48,000 (331) min	60,000 (414) min	17 min	Not Specified
Typical Results ⁽³⁾ - As-Welded	48,000-70,000 (331-483)	60,000-78,000 (414-538)	25-32	-

DEPOSIT COMPOSITION⁽¹⁾ – As Required per AWS A5.1

	%C	%Mn	%Si	%P	%S
Requirements - AWS E6013	0.20 max	1.20 max	1.00 max	Not Specified	Not Specified
Typical Results ⁽³⁾ - As-Welded	0.05-0.09	0.32-0.41	0.29-0.45	0.01-0.02	0.005-0.015
	%Ni	%Cr	%Mo	%V	%Mn + Ni + Cr + Mo + V
Requirements - AWS E6013	0.30 max	0.20 max	0.30 max	0.08 max	Not Specified
Typical Results ⁽³⁾ - As-Welded	0.01-0.06	0.01-0.06	0.01-0.02	0.01-0.02	0.36-0.57

TYPICAL OPERATING PROCEDURES

Polarity ⁽⁴⁾	Current (Amps)				
	5/64 in (2.0 mm)	3/32 in (2.4 mm)	1/8 in (3.2 mm)	5/32 in (4.0 mm)	3/16 in (4.8 mm)
AC	50-80	75-115	110-140	160-200	205-260
DC±	45-75	70-105	100-135	145-180	185-235

⁽¹⁾Typical all weld metal. ⁽²⁾Measured with 0.2% offset. ⁽³⁾See test results disclaimer

MUREX® 7014

Mild Steel, Rutile · AWS E7014

KEY FEATURES

- Good restrike characteristics
- Smooth and transfer and good wetting and low penetration
- Good deposition rates

TYPICAL APPLICATIONS

- Suitable for all types of mild steel fabrications
- Maintenance & repair

CONFORMANCES

AWS A5.1: E7014

ASME SFA-5.1: E7014

WELDING POSITIONS

Specifically designed for vertical down welding of sheet metal and ornamental iron

DIAMETERS / PACKAGING

Diameter in (mm)	50 lb (22.7 kg) Carton
3/32 (2.4)	EDM13181403
1/8 (3.2)	EDM13181414
5/32 (4.0)	EDM13181415
3/16 (4.8)	EDM13181416

MECHANICAL PROPERTIES⁽¹⁾ – As Required per AWS A5.1

	Yield Strength ⁽²⁾ MPa (ksi)	Tensile Strength MPa (ksi)	Elongation %	Charpy V-Notch J (ft-lbf) @-20°C (-29°F)
Requirements - AWS E7014	58,000 (400) min	70,000 (482) min	17 min	Not Specified
Typical Results ⁽³⁾ - As-Welded	58,000-74,000 (399-510)	70,000-83,000 (482-572)	17-29	-
Stress-relieved - 1 hr @ 1150°F (620°C)	55,000-70,000 (379-482)	67,000-77,000 (461-530)	24-30	

DEPOSIT COMPOSITION⁽¹⁾ – As Required per AWS A5.1

	%C	%Mn	%Si	%P	%S
Requirements - AWS E7014	0.15 max	1.25 max	0.90 max	0.035 max	0.035 max
Typical Results ⁽³⁾ - As-Welded	0.04-0.09	0.21-0.70	0.45-0.68	0.010-0.020	0.005-0.015
	%Ni	%Cr	%Mo	%V	%Mn + Ni + Cr + Mo + V
Requirements - AWS E7014	0.30 max	0.20 max	0.30 max	0.08 max	1.50 max
Typical Results ⁽³⁾ - As-Welded	0.01-0.06	0.01-0.06	0.01-0.02	0.01-0.02	0.25-0.86

TYPICAL OPERATING PROCEDURES

Polarity ⁽⁴⁾	Current (Amps)			
	3/32 in (2.4 mm)	1/8 in (3.2 mm)	5/32 in (4.0 mm)	3/16 in (4.8 mm)
AC	80-100	110-155	150-225	200-285
DC±	75-95	100-145	135-200	185-235

⁽¹⁾Typical all weld metal. ⁽²⁾Measured with 0.2% offset. ⁽³⁾See test results disclaimer

JETWELD® 1

Mild Steel, High Deposition · AWS E7024-1

KEY FEATURES

- High deposition rates
- Smooth bead appearance
- Shallow penetration

CONFORMANCES

AWS A5.1:	E7024-1
ABS:	E7024-1
CWB/CSA:	E4924-1

TYPICAL APPLICATIONS

- Large welds
- Slightly downhill (15° max) positions
- Multiple pass welding

WELDING POSITIONS

Flat & Horizontal

DIAMETERS / PACKAGING

Diameter in (mm)	Length in (mm)	50 lb (22.7 kg) Carton
1/8 (3.2)	14 (350)	ED010362
5/32 (4.0)	14 (350)	ED010372
3/16 (4.8)	18 (450)	ED010366
7/32 (5.6)	18 (450)	ED010375
1/4 (6.4)	18 (450)	ED010360

MECHANICAL PROPERTIES⁽¹⁾ – As Required per AWS A5.1

	Yield Strength ⁽²⁾ MPa (ksi)	Tensile Strength MPa (ksi)	Elongation %	Charpy V-Notch J (ft-lbf) @ -18°C (0°F)
Requirements - AWS E7024-1	400 (58) min	490 (70) min	22 min	27 (20) min
Typical Results ⁽³⁾ - As-Welded	455-490 (66-71)	530-565 (77-86)	22-31	27-60 (20-44)

DEPOSIT COMPOSITION⁽¹⁾ – As Required per AWS A5.1

	%C	%Mn	%Si	%P	%S
Requirements - AWS E7024-1	0.15 max	1.25 max	0.90 max	0.035 max	0.035 max
Typical Results ⁽³⁾ - As-Welded	0.03-0.06	0.63-1.02	0.13-0.68	0.010-0.022	0.005-0.011
	%Ni	%Cr	%Mo	%V	%Mn + Ni + Cr + Mo + V
Requirements - AWS E7024-1	0.30 max	0.20 max	0.30 max	0.08 max	1.50 max
Typical Results ⁽³⁾ - As-Welded	≤ 0.06	0.01-0.05	≤ 0.02	0.03 max.	0.75

TYPICAL OPERATING PROCEDURES

Polarity ⁽⁴⁾	Current (Amps)				
	1/8 in (3.2 mm)	5/32 in (4.0 mm)	3/16 in (4.8 mm)	7/32 in (5.6 mm)	1/4 in (6.4 mm)
AC	115-175	180-240	240-300	300-380	340-440
DC±	100-160	160-215	220-280	270-340	320-400

⁽¹⁾Typical all weld metal. ⁽²⁾Measured with 0.2% offset. ⁽³⁾See test results disclaimer. ⁽⁴⁾Preferred polarity is listed first.

MUREX[®] 7024

Mild Steel, High Deposition · AWS E7024

KEY FEATURES

- Good wetting and root fusion in horizontal fillets
- Deposition rate is typically 50% greater than an E7014 electrode
- Self-cleaning slag

TYPICAL APPLICATIONS

- Large welds
- Barge and shipbuilding
- General fabrication
- Rail car

CONFORMANCES

AWS A5.1:	E7024
ASME SFA-5.1:	E7024
ABS:	E7024

WELDING POSITIONS

Flat & horizontal

DIAMETERS / PACKAGING

Diameter in (mm)	50 lb (22.7 kg) Carton
1/8 [3.2]	EDM13181214
5/32 [4.0]	EDM13181215
3/16 [4.8]	EDM13181216
7/32 [5.6]	EDM13181217
1/4 [6.4]	EDM13181218

MECHANICAL PROPERTIES⁽¹⁾ – As Required per AWS A5.1

	Yield Strength ⁽²⁾ MPa (ksi)	Tensile Strength MPa (ksi)	Elongation %
Requirements - AWS E7024	58,000 (399) min	70,000 (482) min	17 min
Typical Results⁽³⁾ - As-Welded	58,000-74,000 (399-510)	70,000-83,000 (482-572)	17-29
Stress-relieved - 1 hr @ 1150°F (620°C)	67,000-77,000 (462-531)	55,000-70,000 (379-483)	24-30

DEPOSIT COMPOSITION⁽¹⁾ – As Required per AWS A5.1

	%C	%Mn	%Si	%P	%S
Requirements - AWS E7024	0.15 max	1.25 max	0.90 max	0.035 max	0.035 max
Typical Results⁽³⁾ - As-Welded	0.04-0.09	0.75-1.10	0.29-0.57	0.010-0.020	0.010-0.020
	%Ni	%Cr	%Mo	%V	%Mn + Ni + Cr + Mo + V
Requirements - AWS E7024	0.30 max	0.20 max	0.30 max	0.08 max	1.50 max
Typical Results⁽³⁾ - As-Welded	0.005-0.015	0.01-0.06	0.01-0.06	0.01-0.02	0.79-1.26

TYPICAL OPERATING PROCEDURES

Polarity ⁽⁴⁾	Current (Amps)				
	1/8 in [3.2 mm]	5/32 in [4.0 mm]	3/16 in [4.8 mm]	7/32 in [5.6 mm]	1/4 in [6.4 mm]
AC	115-175	180-240	240-300	300-380	340-440
DC±	100-160	160-215	220-280	270-340	320-400

⁽¹⁾Typical all weld metal. ⁽²⁾Measured with 0.2% offset. ⁽³⁾See test results disclaimer

SHIELD-ARC® HYP+

Low Alloy, Cellulosic, Pipe · AWS E7010-P1

KEY FEATURES

- Light slag for minimal arc interference
- Deep penetration
- Superior puddle control

CONFORMANCES

AWS A5.5:	E7010-P1, E7010-G
ABS:	E7010-P1
CWB/CSA:	E4910-P1

TYPICAL APPLICATIONS

- Hot, fill and cap pass of up to X65 grade pipe
- Root pass welding of up to X80 grade pipe

WELDING POSITIONS

Recommended for vertical down welding

DIAMETERS / PACKAGING

Diameter in (mm)	Length in (mm)	50 lb (22.7 kg) Easy Open Can
1/8 (3.2)	14 (350)	ED029511
5/32 (4.0)	14 (350)	ED029513
3/16 (4.8)	14 (350)	ED029509

MECHANICAL PROPERTIES⁽¹⁾ – As Required per AWS A5.5

	Yield Strength ⁽²⁾ MPa (ksi)	Tensile Strength MPa (ksi)	Elongation %	Charpy V-Notch J (ft-lbf) @ -29°C (-20°F)
Requirements - AWS E7010-P1	415 (60) min	490 (70) min	22 min	27 (20) min
Typical Results ⁽³⁾ - As-Welded	435-525 (63-76)	525-635 (76-92)	22-28	27-56 (20-41)

DEPOSIT COMPOSITION⁽¹⁾ – As Required per AWS A5.5

	%C	%Mn	%Si	%P	%S
Requirements - AWS E7010-P1	0.20 max	1.20 max	0.60 max	0.03 max	0.03 max
Typical Results ⁽³⁾	0.13-0.17	0.43-0.63	0.08-0.18	≤ 0.01	≤ 0.01
	%Ni	%Cr	%Mo	%V	
Requirements - AWS E7010-P1	1.00 max	0.30 max	0.50 max	0.10 max	
Typical Results ⁽³⁾	0.01-0.02	0.02	0.27-0.31	< 0.01	

TYPICAL OPERATING PROCEDURES

Polarity	Current (Amps)		
	1/8 in (3.2 mm)	5/32 in (4.0 mm)	3/16 in (4.8 mm)
DC+	75-130	90-185	140-225

⁽¹⁾Typical all weld metal. ⁽²⁾Measured with 0.2% offset. ⁽³⁾See test results disclaimer

SHIELD-ARC[®] 85

Low Alloy, Cellulosic, Pipe · AWS E7010-A1

KEY FEATURES

- For welding 0.50% molybdenum steel
- Deep penetration and superior puddle control

TYPICAL APPLICATIONS

- API 5L X42 through X56 grade pipe
- Cross country and in-plant pipe

CONFORMANCES

AWS A5.5:	E7010-A1
ABS:	E7010-A1
CWB/CSA:	E4910-A1

WELDING POSITIONS

All

DIAMETERS / PACKAGING

Diameter in (mm)	Length in (mm)	50 lb (22.7 kg) Easy Open Can
3/32 [2.4]	12 [300]	ED012893
1/8 [3.2]	14 [350]	ED012885
5/32 [4.0]	14 [350]	ED012896
3/16 [4.8]	14 [350]	ED012889

MECHANICAL PROPERTIES⁽¹⁾ – As Required per AWS A5.5

	Yield Strength ⁽²⁾ MPa (ksi)	Tensile Strength MPa (ksi)	Elongation %	Charpy V-Notch J (ft-lbf) @ -29°C (-20°F)
Requirements - AWS E7010-A1	390 [57] min	490 [70] min	22 min	Not Specified
Typical Results⁽³⁾ - As-Welded Stress-Relieved 1 hr @ 620°C (1150°F)	440-510 [64-74]	540-580 [78-84]	25-30	35-43 [26-32]

DEPOSIT COMPOSITION⁽¹⁾ – As Required per AWS A5.5

	%C	%Mn	%Si	%P	%S	%Mo
Requirements - AWS E7010-A1	0.12 max	0.60 max	0.40 max	0.03 max	0.03 max	0.40-0.65
Typical Results⁽³⁾	0.07-0.12	0.29-0.59	0.08-0.26	0.01-0.02	≤ 0.01	0.40-0.62

TYPICAL OPERATING PROCEDURES

Polarity	Current (Amps)			
	3/32 in [2.4 mm]	1/8 in [3.2 mm]	5/32 in [4.0 mm]	3/16 in [4.8 mm]
DC+	50-90	75-130	90-175	140-225

⁽¹⁾Typical all weld metal. ⁽²⁾Measured with 0.2% offset. ⁽³⁾See test results disclaimer

SHIELD-ARC® 70+

Low Alloy, Cellulosic, Pipe · AWS E8010-G, Also meets E8010-P1

KEY FEATURES

- Recommend to switch to Pipeliner® Arc 80 for superior puddle control and visibility
- Light slag for minimal arc interference
- Deep penetration

TYPICAL APPLICATIONS

- API 5L X56 through X70 grade pipe
- Relatively high silicon pipe
- Cross country and in-plant pipe

CONFORMANCES

AWS A5.5:	E8010-G E8010-P1
ABS:	E8010-G
CWB/CSA:	E5510-G

WELDING POSITIONS

Vertical down recommended for pipe welding

DIAMETERS / PACKAGING

Diameter in (mm)	Length in (mm)	50 lb (22.7 kg) Easy Open Can
1/8 [3.2]	14 [350]	ED012841
5/32 [4.0]	14 [350]	ED012849
3/16 [4.8]	14 [350]	ED012845

MECHANICAL PROPERTIES⁽¹⁾ – As Required per AWS A5.5

	Yield Strength ⁽²⁾ MPa (ksi)	Tensile Strength MPa (ksi)	Elongation %	Charpy V-Notch J [(ft-lbf)]	
				@ -29°C [-20°F]	@ -46°C [-50°F]
Requirements - AWS E8010-G	460 [67] min	550 [80] min	19 min	Not Specified	Not Specified
Typical Results⁽³⁾ - As-Welded	460-620 [67-90]	585-690 [85-100]	19-31	37-81 [27-60]	26-64 [19-47]

DEPOSIT COMPOSITION⁽¹⁾ – As Required per AWS A5.5

	%C	%Mn ⁽⁴⁾	%Si ⁽⁴⁾	%P	%S
Requirements - AWS E8010-G	Not Specified	1.00 min.	0.80 min.	0.03 max.	0.03 max.
Typical Results⁽³⁾	0.13-0.17	0.60-1.20	0.05-0.30	≤ 0.01	≤ 0.01
	%Ni ⁽⁴⁾	%Cr ⁽⁴⁾	%Mo ⁽⁴⁾	%V ⁽⁴⁾	
Requirements - AWS E8010-G	0.50 min.	0.30 min.	0.20 min.	0.10 min.	
Typical Results⁽³⁾	0.75-0.97	0.01-0.20	0.35-0.45	0.02-0.04	

TYPICAL OPERATING PROCEDURES

Polarity	Current (Amps)		
	1/8 in [3.2 mm]	5/32 in [4.0 mm]	3/16 in [4.8 mm]
DC+	75-130	90-185	140-225

⁽¹⁾Typical all weld metal. ⁽²⁾Measured with 0.2% offset. ⁽³⁾See test results disclaimer. ⁽⁴⁾In order to meet the alloy requirements of the "G" designation, the undiluted weld metal shall have the minimum of at least one of the elements listed.

SHIELD-ARC® 90

Low Alloy, Cellulosic, Pipe · AWS E9010-G

KEY FEATURES

- Light slag for minimal arc interference
- Deep penetration

TYPICAL APPLICATIONS

- Hot pass welding of up to X80 grade pipe, when followed by low hydrogen fill and cap
- API 5L X70 through X80 grade pipe

CONFORMANCES

AWS A5.5: E9010-G

WELDING POSITIONS

All

DIAMETERS / PACKAGING

Diameter mm (in)	Length in (mm)	50 lb (22.7 kg) Easy Open Can
3.2 (1/8)	14 (350)	EDS01693
4.0 (5/32)	14 (350)	EDS01694
5.0 (3/16)	14 (350)	EDS01695

MECHANICAL PROPERTIES⁽¹⁾ – As Required per AWS A5.5

	Yield Strength ⁽²⁾ MPa (ksi)	Tensile Strength MPa (ksi)	Elongation %	Charpy V-Notch J (ft-lbf)	
				@ -29°C (-20°F)	@ -46°C (-50°F)
Requirements - AWS E9010-G	530 (77) min	620 (90) min	17 min.	Not Specified	Not Specified
Typical Results⁽³⁾ - As-Welded	530-605 (77-88)	620-690 (90-100)	17-29	45-94 (33-69)	28-62 (21-46)

DEPOSIT COMPOSITION⁽¹⁾ – As Required per AWS A5.5

	%C	%Mn ⁽⁴⁾	%Si ⁽⁴⁾	%P	%S
Requirements - AWS E9010-G	Not Specified	1.00 min	0.80 min	0.03 max	0.03 max
Typical Results⁽³⁾	0.13-0.18	0.55-0.79	0.08-0.22	0.01-0.02	≤ 0.01
	%Ni ⁽⁴⁾	%Cr ⁽⁴⁾	%Mo ⁽⁴⁾	%V ⁽⁴⁾	
Requirements - AWS E9010-G	0.50 min	0.30 min	0.20 min	0.10 min	
Typical Results⁽³⁾	0.66-0.77	0.01-0.06	0.43-0.70	≤ 0.01	

TYPICAL OPERATING PROCEDURES

Polarity	Current (Amps)		
	3.2 mm (1/8 in)	4.0 mm (5/32 in)	4.8 mm (3/16 in)
DC+	75-130	80-185	140-225

⁽¹⁾Typical all weld metal. ⁽²⁾Measured with 0.2% offset. ⁽³⁾See test results disclaimer ⁽⁴⁾In order to meet the alloy requirements of the "G" designation, the undiluted weld metal shall have the minimum of at least one of the elements listed.

GMAW & GTAW CONSUMABLES

MIG & TIG



SUPERGLIDE® S3

Mild Steel, Non-Copper Coated Wire • AWS ER70S-3

KEY FEATURES

- Moderate levels of manganese and silicon for deoxidization of clean to light mill scale surfaces
- MicroGuard® Ultra provides superior feeding and arc stability
- Supports short-circuiting, globular, axial spray and pulsed spray transfer
- Non-copper coated

WELDING POSITIONS

All

SHIELDING GAS

100% CO₂

75-95% Argon / Balance CO₂

95-98% Argon / Balance O₂

Flow Rate: 30-50 CFH

CONFORMANCES

AWS A5.18: ER70S-3

CWB/CSA W48: B-G 49A 2 C1 S3 [B-G 49A 2 C1 G3]

ISO 14341-B: G 49A 2 C1 S3

TYPICAL APPLICATIONS

- Clean to light mill scale base material
- Sheet metal to 380-485 MPa [55-70 ksi] yield strength material
- Pipeline
- Pressure vessels
- Structural steel

DIAMETERS / PACKAGING

Diameter in (mm)	44 lb (20 kg) Fiber Spool	500 lb (227 kg) Accu-Trak® Drum
0.035 (0.9)	ED028621	ED030772
0.045 (1.1)	ED028622	ED030773

MECHANICAL PROPERTIES⁽¹⁾ – As Required per AWS A5.18

	Yield Strength ⁽²⁾ MPa (ksi)	Tensile Strength MPa (ksi)	Elongation %	Charpy V-Notch J (ft-lbf)	
				@ -18°C [0°F]	@ -29°C [-20°F]
Requirements - AWS ER70S-3 As-Welded with 100% CO ₂	400 [58] min	485 [70] min	22 min	27 [20] min	Not Specified
Typical Results⁽³⁾ - As-Welded with 100% CO ₂	405 [59]	510 [74]	26	100 [74]	87 [64]

WIRE COMPOSITION – As Required per AWS A5.18

	%C	%Mn	%Si	%S	%P
Requirements - AWS ER70S-3	0.006-0.15	0.90-1.40	0.45-0.75	0.035 max	0.025 max
Typical Results⁽¹⁾	0.07-0.10	1.15-1.27	0.52-0.59	0.002-0.008	0.005-0.013
	%Cr	%Mo	%Ni	%V	%Cu
Requirements - AWS ER70S-3	0.15 max	0.15 max	0.15 max	0.03 max	0.50 max
Typical Results⁽²⁾	≤ 0.03	≤ 0.01	≤ 0.04	< 0.01	0.02-0.04

TYPICAL OPERATING PROCEDURES

Diameter, Polarity Shielding Gas	CTWD ⁽⁴⁾ mm (in)	Wire Feed Speed m/min (in/min)	Voltage (volts)	Approx. Current (amps)	Melt-Off Rate kg/hr (lb/hr)
0.035 in (0.9 mm), DC+					
Short Circuit Transfer 100% CO ₂ ⁽⁵⁾	9-12 (3/8-1/2)	2.5 (100)	18	80	0.7 (1.6)
		3.8 (150)	19	120	1.1 (2.4)
		6.4 (250)	22	175	1.8 (4.0)
Spray Transfer 90% Ar/10% CO ₂	12-19 (1/2-3/4)	9.5 (375)	23	195	2.7 (6.0)
		12.7 (500)	29	230	3.6 (8.0)
		15.2 (600)	30	275	4.4 (9.6)
0.045 in (1.1 mm), DC+					
Short Circuit Transfer 100% CO ₂ ⁽⁵⁾	12-19 (1/2-3/4)	3.2 (125)	19	145	1.5 (3.4)
		3.8 (150)	20	165	1.8 (4.0)
		5.1 (200)	21	200	2.4 (5.4)
Spray Transfer 90% Ar/10% CO ₂	12-19 (1/2-3/4)	8.9 (350)	27	285	4.2 (9.2)
		12.1 (475)	30	335	5.7 (12.5)
		12.7 (500)	30	340	6.0 (13.2)

⁽¹⁾Typical all weld metal. ⁽²⁾Measured with 0.2% offset. ⁽³⁾See test results disclaimer. ⁽⁴⁾CTWD (Contact Tip to Work Distance). Subtract 1/4 in (6.4 mm) to calculate Electrical Stickout.
⁽⁵⁾Procedures in these areas are procedures for short circuiting mode using 100% CO₂. When using 75% Argon, 25% CO₂ for short circuit transfer, reduce voltage by 1 to 2 volts.

SUPERGLIDE® S6

Mild Steel, Non-Copper Coated Wire · AWS ER70S-6

KEY FEATURES

- High levels of manganese and silicon deoxidizers tolerate medium to heavy mill scale surfaces
- MicroGuard® Ultra provides superior feeding and arc stability
- Supports short-circuiting, globular, axial spray and pulsed spray transfer
- Non-copper coated

WELDING POSITIONS

All

SHIELDING GAS

100% CO₂
 75-95% Argon / Balance CO₂
 95-98% Argon / Balance O₂
 Flow Rate: 30 - 50 CFH

CONFORMANCES

AWS A5.18: ER70S-6
CWB/CSA W48: B-G 49A 3 C1 S6 (B-G 49A 3 C G6)
ISO 14341-B: G 49A 3 C1 S6

TYPICAL APPLICATIONS

- Medium to heavy mill scale base material
- Sheet metal to 380 - 485 MPa (55 - 70 ksi) yield strength material
- Automotive repair
- Structural steel

DIAMETERS / PACKAGING

Diameter in (mm)	44 lb (20 kg) Fiber Spool	500 lb (227 kg) Accu-Trak® Drum	900 lb (408 kg) Accu-Trak® Drum
0.035 (0.9)	ED028635		ED034560
0.045 (1.1)	ED028636	ED030695	ED034561

MECHANICAL PROPERTIES⁽¹⁾ – As Required per AWS A5.18

	Yield Strength ⁽²⁾ MPa (ksi)	Tensile Strength MPa (ksi)	Elongation %	Charpy V-Notch J (ft-lbf) @ -29°C (-20°F)
Requirements - AWS ER70S-6 As-Welded with 100% CO ₂	400 (58) min	485 (70) min	22 min	27 (20) min
Typical Results⁽³⁾ - As-Welded with 100% CO ₂	430 (62)	540 (78)	28	71 (52)

WIRE COMPOSITION – As Required per AWS A5.18

	%C	%Mn	%Si	%S	%P
Requirements - AWS ER70S-6	0.06-0.15	1.40-1.85	0.80-1.15	0.035 max	0.025 max
Typical Results⁽³⁾	0.08-0.09	1.42-1.65	0.81-0.87	0.006-0.010	0.004-0.010
	%Cr	%Ni	%Mo	%V	%Cu (Total)
Requirements - AWS ER70S-6	0.15 max	0.15 max	0.15 max	0.03 max	0.50 max
Typical Results⁽³⁾	0.01-0.05	≤ 0.04	≤ 0.01	< 0.01	0.01-0.04

TYPICAL OPERATING PROCEDURES

Diameter, Polarity Shielding Gas	CTWD ⁽⁴⁾ mm (in)	Wire Feed Speed m/min (in/min)	Voltage (volts)	Approx. Current (amps)	Melt-Off Rate kg/hr (lb/hr)
0.035 in (0.9 mm), DC+					
Short Circuit Transfer 100% CO ₂ ⁽⁵⁾	9-12 (3/8-1/2)	2.5 (100)	18	80	0.7 (1.6)
		3.8 (150)	19	120	1.1 (2.4)
		6.4 (250)	22	175	1.8 (4.0)
Spray Transfer 90% Ar/10% CO ₂	12-19 (1/2-3/4)	9.5 (375)	23	195	2.7 (6.0)
		12.7 (500)	29	230	3.6 (8.0)
		15.2 (600)	30	275	4.4 (9.6)
0.045 in (1.1 mm), DC+					
Short Circuit Transfer 100% CO ₂ ⁽⁵⁾	12-19 (1/2-3/4)	3.2 (125)	19	145	1.5 (3.4)
		3.8 (150)	20	165	1.8 (4.0)
		5.1 (200)	21	200	2.4 (5.4)
Spray Transfer 90% Ar/10% CO ₂	12-19 (1/2-3/4)	8.9 (350)	27	285	4.2 (9.2)
		12.1 (475)	30	335	5.7 (12.5)
		12.7 (500)	30	340	6.0 (13.2)

⁽¹⁾Typical all weld metal. ⁽²⁾Measured with 0.2% offset. ⁽³⁾See test results disclaimer. ⁽⁴⁾CTWD (Contact Tip to Work Distance). Subtract 1/4 in (6.4 mm) to calculate Electrical Stickout.

⁽⁵⁾Procedures in these areas are procedures for short circuiting mode using 100% CO₂. When using 75% Argon, 25% CO₂ for short circuit transfer, reduce voltage by 1 to 2 volts.

SUPERARC® L-50®

Mild Steel, Copper Coated · AWS ER70S-3 & EM13K



KEY FEATURES

- Moderate levels of manganese and silicon for deoxidization of clean to light mill scale surfaces
- Copper coating provides superior arc-starting characteristics for long contact tip life
- Supports short-circuiting, globular, axial spray and pulsed spray transfer
- MicroGuard® Ultra provides superior feeding and arc stability

WELDING POSITIONS

All

SHIELDING GAS

100% CO₂
 75-95% Argon / Balance CO₂
 95-98% Argon / Balance O₂
 Flow Rate: 30-50 CFH

CONFORMANCES

AWS A5.18:	ER70S-3
ABS - Part 2:	3YSA H5
CWB/CSA W48:	B-G 49A 3 C1 S3 (B-G 49A 3 C1 G3)
DNV - 2.9:	III YMS H5
Lloyd's Register - Chapter 11:	3YS H5
ISO 14341-B:	G 49A 2 C1 S3

TYPICAL APPLICATIONS

- Clean to light mill scale base material
- Pipeline and processing pipe
- Sheet metal to 380 - 485 MPa (55 - 70 ksi) yield strength material
- Pressure vessels
- Structural steel

DIAMETERS / PACKAGING

Diameter in (mm)	33 lb (15 kg) Plastic Spool	33 lb (15 kg) Steel Spool	44 lb (20 kg) Steel Spool	44 lb (20 kg) Fiber Spool	60 lb (27.2 kg) Coil
0.030 (0.8)	ED032923	ED031407			
0.035 (0.9)	ED032924	ED031408	ED031914	ED021268, ED036624*	
0.045 (1.1)	ED032925	ED031409, ED036879*	ED031915	ED021270, ED034428*	
0.052 (1.3)			ED031916		ED011317
1/16 (1.6)					
Diameter in (mm)	60 lb (27.2 kg) Fiber Spool	500 lb (227 kg) Accu-Trak® Drum	500 lb (227 kg) Accu-Pak® Box	500 lb (227 kg) Infinity-Pak®	600 lb (272 kg) Speed-Feed® Drum
0.030 (0.8)		ED029223			
0.035 (0.9)	ED021269	ED021052	ED032899		
0.040 (1.0)					
0.045 (1.1)	ED021271	ED020526	ED032901	ED034535	
0.052 (1.3)	ED021273	ED020527	ED032902		
1/16 (1.6)	ED027274		ED032903		ED011316
Diameter in (mm)	900 lb (408 kg) Accu-Pak® Box	1000 lb (454 kg) Accu-Trak® Drum	1000 lb (454 kg) Accu-Pak® Box	1000 lb (454 kg) Precise-Trak® Reel	1000 lb (454 kg) Infinity-Pak®
0.030 (0.8)					
0.035 (0.9)	ED032842	ED028825		ED032379	
0.040 (1.0)			ED033292	ED032380	
0.045 (1.1)		ED028826	ED032844	ED031614	ED031930
0.052 (1.3)		ED029082	ED032845	ED031615	ED034464
1/16 (1.6)		ED029083	ED032846	ED033270	

*Buy America Product

MECHANICAL PROPERTIES⁽¹⁾ – As Required per AWS A5.18

	Yield Strength ⁽²⁾ MPa (ksi)	Tensile Strength MPa (ksi)	Elongation %	Charpy V-Notch - J (ft-lbf)	
				@ -18°C [0°F]	@ -29°C [-20°F]
Requirements - AWS ER70S-3 As-Welded with 100% CO ₂	400 [58] min	485 [70] min	22 min	27 [20] min	Not Specified
MIL-70S-3 per MIL-E-23765/1 As-Welded with CO ₂ and 98% Ar/2% O ₂	380-485 [55-70]	485 [70] min	22 min	Not Specified	Not Specified
Typical Results⁽³⁾					
As-Welded with 100% CO ₂	415 [60]	515 [75]	26	95 [70]	88 [65]
Stress Relieved 1 hr. @ 621°C [1150°F]	365 [53]	475 [69]	34	118 [87]	100 [74]
As-Welded with 75% Ar/25% CO ₂	420 [61]	525 [76]	28	106 [78]	102 [75]
Stress Relieved 1 hr. @ 621°C [1150°F]	365 [53]	490 [71]	33	165 [122]	163 [120]
As-Welded with 90% Ar/10% CO ₂	450 [65]	545 [79]	30	142 [105]	122 [90]
Stress Relieved 1 hr. @ 621°C [1150°F]	365 [53]	485 [70]	35	–	214 [158]
As-Welded with 98% Ar/2% O ₂	425 [62]	540 [78]	27	108 [80]	95 [70]
Stress Relieved 1 hr. @ 621°C [1150°F]	350 [51]	475 [69]	33	–	339 [250]

WIRE COMPOSITION – As Required per AWS A5.18

	%C	%Mn	%Si	%S	%P
Requirements - AWS ER70S-3	0.006-0.15	0.90-1.40	0.45-0.75	0.035 max	0.025 max
Typical Results⁽³⁾	0.08-0.11	1.14-1.23	0.53-0.59	0.003-0.009	0.003-0.013
	%Cr	%Mo	%Ni	%V	%Cu (Total) ⁽⁴⁾
Requirements - AWS ER70S-3	0.15 max	0.15 max	0.15 max	0.03 max	0.50 max
Typical Results⁽³⁾	≤ 0.04	≤ 0.02	≤ 0.03	< 0.01	0.15-0.25

TYPICAL OPERATING PROCEDURES

Diameter, Polarity Shielding Gas	CTWD ⁽⁵⁾ mm (in)	Wire Feed Speed m/min (in/min)	Voltage (volts)	Approx. Current (amps)	Melt-Off Rate kg/hr (lb/hr)
0.030 in (0.8 mm), DC+					
Short Circuit Transfer 100% CO ₂	9-12 (3/8-1/2)	1.9 [75]	17	35	0.4 [0.9]
		3.8 [150]	18	70	0.8 [1.8]
		7.6 [300]	22	130	1.6 [3.6]
0.035 in (0.9 mm), DC+					
Short Circuit Transfer 100% CO ₂ ⁽⁶⁾	9-12 (3/8-1/2)	2.5 [100]	18	80	0.7 [1.6]
		3.8 [150]	19	120	1.1 [2.4]
		6.4 [250]	22	175	1.8 [4.0]
Spray Transfer 90% Ar/10% CO ₂	12-19 (1/2-3/4)	9.5 [375]	23	195	2.7 [6.0]
		12.7 [500]	29	230	3.6 [8.0]
		15.2 [600]	30	275	4.4 [9.6]
0.045 in (1.1 mm), DC+					
Short Circuit Transfer 100% CO ₂ ⁽⁶⁾	12-19 (1/2-3/4)	3.2 [125]	19	145	1.5 [3.4]
		3.8 [150]	20	165	1.8 [4.0]
		5.1 [200]	21	200	2.5 [5.4]
Spray Transfer 90% Ar/10% CO ₂	12-19 (1/2-3/4)	8.9 [350]	27	285	4.2 [9.2]
		12.1 [475]	30	335	5.7 [12.5]
		12.7 [500]	30	340	6.0 [13.2]
0.052 in (1.3 mm), DC+					
Spray Transfer 90% Ar/10% CO ₂	12-19 (1/2-3/4)	7.6 [300]	30	300	4.8 [10.6]
		8.1 [320]	30	320	5.2 [11.5]
		12.3 [485]	32	430	7.8 [17.1]
1/16 in (1.6 mm), DC+					
Spray Transfer 90% Ar/10% CO ₂	12-25 (1/2-1)	5.3 [210]	25	325	4.8 [10.7]
		6.0 [235]	27	350	5.4 [12.0]
		7.4 [290]	28	430	6.7 [14.8]

⁽¹⁾Typical all weld metal. ⁽²⁾Measured with 0.2% offset. ⁽³⁾See test results disclaimer. ⁽⁴⁾Copper due to any coating on the electrode plus the copper content of the filler metal itself, shall not exceed the stated 0.50% max.⁽⁵⁾CTWD (Contact Tip to Work Distance). Subtract 1/4 in (6.4 mm) to calculate Electrical Stickout. ⁽⁶⁾Procedures in these areas are procedures for short circuiting mode using 100% CO₂. When using 75% Argon, 25% CO₂, for short circuit transfer, reduce voltage by 1 to 2 volts.

SUPERARC® L-52™

Mild Steel, Copper Coated · AWS ER70S-2, ER70S-2

KEY FEATURES

- Triple deoxidized (Aluminum, Titanium, Zirconium) ER70S-2 solid wire designed for welding over rust and mill scale without sacrificing weld quality
- Very low nitrogen in the steel to help achieve impact resistance above 70 ft-lbs @ -20°F
- Microguard® Ultra provides superior feeding, arc stability and improved protection against corrosion
- Copper coating promotes excellent arc starting and extremely low contact tip wear.
- Very low spatter levels and fume emissions.
- Preferred for all position welding of different sizes of pipe.

CONFORMANCES

AWS A5.18: ER70S-2

TYPICAL APPLICATIONS

- Root, fill and cap pass welding for Piping industries
- Metal Fabrication
- Power Generation

WELDING POSITIONS

All

SHIELDING GAS

100% CO₂
75-95% Argon/ Balance CO₂
Flow Rate: 30-50 CFH

DIAMETERS / PACKAGING

Diameter in (mm)	33 lb (15 kg) Steel Spool	44 lb (20 kg) Steel Spool
0.035 (0.9)	ED037003	ED037004
0.045 (1.1)	ED037005	ED037006

MECHANICAL PROPERTIES⁽¹⁾ – As Required per AWS A5.18

	Yield Strength ⁽²⁾ MPa (ksi)	Tensile Strength MPa (ksi)	Elongation %	Charpy V-Notch - J [ft-lbf] @ -30°C (-20°F)
Requirements - AWS ER70S-2 As-Welded with 100% CO ₂	400 (58) min	485 (70) min	22 min	27 (20) min
Typical Results⁽³⁾ As-Welded with 100% CO ₂	440 (63)	520 (76)	30	129 (95)

⁽¹⁾Typical all weld metal. ⁽²⁾Measured with 0.2% offset.

WIRE COMPOSITION⁽¹⁾ – As Required per AWS A5.18

	%C	%Mn	%Si	%S	%P	%Cr	%Ni
Requirements - AWS ER70S-2	0.07 max	0.90-1.40	0.40-0.70	0.035 max	0.025 max	0.15 max	0.015 max
Typical Results⁽²⁾	0.04	1.10	0.59	< 0.003	0.003	0.06	0.03
	%Mo	%V	%Ti	%Zr	%Al	%Cu (Total) ⁽⁴⁾	
Requirements - AWS ER70S-2	0.15 max	0.03 max	0.05-0.15	0.02-0.12	0.05-0.15	0.50 max	
Typical Results⁽³⁾	0.01	0.01	0.10	0.03	0.07	0.21	

TYPICAL OPERATING PROCEDURES

Diameter, Polarity Shielding Gas	CTWD ⁽⁵⁾ mm (in)	Wire Feed Speed m/min (in/min)	Voltage (volts)	Approx. Current (amps)	Melt-Off Rate kg/hr (lb/hr)
0.035 in (0.9 mm), DC+ 100% CO ₂	12-19 (1/2-3/4)	5.6-19.8 (220-780)	19-31	105-320	1.6-5.7 (3.6-12.6)
0.045 in (1.1 mm), DC+ 100% CO ₂	12-19 (1/2-3/4)	5.1-15.2 (200-600)	19-31	145-360	2.4-7.2 (5.3-15.9)

⁽¹⁾Typical all weld metal. ⁽²⁾Measured with 0.2% offset. ⁽³⁾See test results disclaimer. ⁽⁴⁾Copper due to any coating on the electrode plus the copper content of the filler metal itself, shall not exceed the stated 0.50% max. ⁽⁵⁾CTWD (Contact Tip to Work Distance). Subtract 1/4 in (6.4 mm) to calculate Electrical Stickout.

SUPERARC® L-56®

Mild Steel, Copper Coated · AWS ER70S-6 & EH11K



KEY FEATURES

- High levels of manganese and silicon deoxidizers tolerate medium to heavy mill scale surfaces
- Excellent toe-wetting provides optimal bead appearance
- Copper coating provides superior arc-starting characteristics for long contact tip life
- Supports short-circuiting, globular, axial spray and pulsed spray transfer
- MicroGuard® Ultra provides superior feeding and arc stability

TYPICAL APPLICATIONS

- Medium to heavy mill scale base material
 - Automotive repair
- Sheet metal to 380-485 MPa (55-70 ksi) yield strength material
 - Robotic or hard automation
 - Structural steel
 - Pressure vessels

CONFORMANCES

AWS A5.18:	ER70S-6
ABS - Part 2:	3YSA H5
CWB/CSA W48:	B-G 49A 3 C1 S6 (B-G 49A 3 C G6)
DNV - 2.9:	III YMS and III YMS H5
Lloyd's Register - Chapter 11:	3YS H5
ISO 14341-A:	G 42 3 C1 3Si1 G 46 4 M21 3Si1 G 42 4 M20 3Si1
ISO 14341-B:	G 49A 3 C1 S6
ASME Section IX:	A-No. 1

WELDING POSITIONS

All

SHIELDING GAS

100% CO ₂	95-98% Argon / Balance O ₂
75-95% Argon / Balance CO ₂	Flow Rate: 30-50 CFH

DIAMETERS / PACKAGING

Diameter in (mm)	2 lb (1 kg) Plastic Spool 10 lb (4.5 kg) Master Carton	12.5 lb (5.7 kg) Plastic Spool	33 lb (15 kg) Plastic Spool	33 lb (15 kg) Steel Spool	44 lb (20 kg) Steel Spool
0.025 (0.6)	ED030583	ED015790			
0.030 (0.8)	ED030631	ED023334	ED032926		
0.035 (0.9)	ED030632	ED028676	ED032927	ED031411	ED025945
0.045 (1.1)		ED029042	ED032928	ED031412	ED025946
Diameter in (mm)	44 lb (20 kg) Fiber Spool	60 lb (27.2 kg) Coil	60 lb (27.2 kg) Fiber Spool	250 lb (113.4 kg) Accu-Trak® Drum	
0.030 (0.8)				ED029914	
0.035 (0.9)	ED021274, ED033704*		ED021275		
0.040 (1.0)	ED027384			ED029915	
0.045 (1.1)	ED021276, ED033703*, ED033328**		ED021277, ED036730*	ED029916	
0.052 (1.3)	ED021278, ED033705*		ED021279		
1/16 (1.6)		ED011666, ED033710*			
Diameter in (mm)	500 lb (227 kg) Accu-Trak® Drum	500 lb (227 kg) Accu-Pak® Box	500 lb (227 kg) Infinity-Pak	1000 lb (454 kg) Infinity-Pak	
0.030 (0.8)	ED030771			ED036632	
0.035 (0.9)	ED021056	ED032904			
0.040 (1.0)	ED031937		ED034394	ED036633	
0.045 (1.1)	ED020532, ED036219**	ED032906, ED034248**			
0.052 (1.3)	ED020533	ED032907			
1/16 (1.6)	ED029225, ED033707*				
Diameter in (mm)	900 lb (408 kg) Accu-Pak® Box	1000 lb (454 kg) Accu-Trak® Drum	1000 lb (454 kg) Accu-Pak® Box	1000 lb (454 kg) Precise-Trak® Reel	
0.035 (0.9)	ED032847, ED034429*	ED028827		ED033271	
0.040 (1.0)		ED031032			
0.045 (1.1)		ED028828		ED031616	
0.052 (1.3)		ED029084	ED032849, ED033706*	ED031617	
1/16 (1.6)		ED029085	ED032850, ED033702* ED032851		

*Buy America Product **Tested Material

MECHANICAL PROPERTIES⁽¹⁾ – As Required per AWS A5.18

	Yield Strength ⁽²⁾ MPa (ksi)	Tensile Strength MPa (ksi)	Elongation %	Charpy V-Notch J (ft.-lbf)	
				@ -29°C (-20°F)	@ -40°C (-40°F)
Requirements - AWS ER70S-6 As-Welded with 100% CO ₂	400 (58) min	485 (70) min	22 min.	27 (20) min.	Not Specified
MIL-70S-6 per MIL-E-23765/1 As-Welded with CO ₂ and 98% Ar/2% O ₂	380-550 (55-80)	485 (70) min	22 min	Not Specified	Not Specified
MIL-70S-6 per MIL-E-23765/1 Stress Relieved 1 hr. @ 621°C (1150° F) with CO ₂ and 98% Ar/2% O ₂	360 (52) min	485 (70) min	26 min	27 (20) min	Not Specified
Typical Results⁽³⁾ As-Welded with 100% CO ₂ Stress Relieved 1 hr. @ 621°C (1150°F)	440 (64) 395 (57)	560 (81) 510 (74)	29 29	71 (52) 95 (70)	61 (45) 68 (50)
As-Welded with 75% Ar/25% CO ₂ Stress Relieved 1 hr. @ 621°C (1150°F)	460 (67) 415 (60)	565 (82) 540 (78)	27 31	82 (60) 140 (103)	72 (53) 122 (90)
As-Welded with 90% Ar/10% CO ₂ Stress Relieved 1 hr. @ 621°C (1150°F)	470 (68) 440 (64)	580 (84) 550 (80)	28 32	119 (88) 183 (135)	78 (57) 156 (115)
As-Welded with 98% Ar/2% O ₂ Stress Relieved 1 hr. @ 621°C (1150°F)	455 (66) 415 (60)	565 (82) 545 (79)	27 34	122 (90) 190 (140)	108 (80) 176 (130)

WIRE COMPOSITION – As Required per AWS A5.18

	%C	%Mn	%Si	%S	%P
Requirements - AWS ER70S-6	0.06-0.15	1.40-1.85	0.80-1.15	0.035 max	0.025 max
Typical Results⁽³⁾	0.08-0.09	1.42-1.60	0.81-0.87	0.006-0.010	0.004-0.010
	%Cr	%Ni	%Mo	%V	%Cu (Total) ⁽⁴⁾
Requirements - AWS ER70S-6	0.15 max	0.15 max	0.15 max	0.03 max	0.50 max
Typical Results⁽³⁾	0.01-0.05	≤ 0.04	≤ 0.01	< 0.01	0.17-0.22

TYPICAL OPERATING PROCEDURES

Diameter, Polarity Shielding Gas	CTWD ⁽⁵⁾ mm (in)	Wire Feed Speed m/min (in/min)	Voltage (volts)	Approx. Current (amps)	Melt-Off Rate kg/hr (lb/hr)
0.025 in (0.6 mm), DC+					
Short Circuit Transfer 100% CO ₂	9-12 (3/8-1/2)	2.5 (100)	17	35	0.4 (0.9)
		6.4 (250)	19	80	0.9 (2.0)
0.030 in (0.8 mm), DC+					
Short Circuit Transfer 100% CO ₂	9-12 (3/8-1/2)	1.9 (75)	17	35	0.4 (0.9)
		3.8 (150)	18	70	0.8 (1.8)
		7.6 (300)	22	130	1.6 (3.6)
0.035 in (0.9 mm), DC+					
Short Circuit Transfer 100% CO ₂ ⁽⁶⁾	9-12 (3/8-1/2)	2.5 (100)	18	80	0.7 (1.6)
		3.8 (150)	19	120	1.1 (2.4)
		6.4 (250)	22	175	1.8 (4.0)
Spray Transfer 90% Ar/10% CO ₂	12-19 (1/2-3/4)	9.5 (375)	23	195	2.7 (6.0)
		12.7 (500)	29	230	3.6 (8.0)
		15.2 (600)	30	275	4.4 (9.6)
0.045 in (1.1 mm), DC+					
Short Circuit Transfer 100% CO ₂ ⁽⁶⁾	12-19 (1/2-3/4)	3.2 (125)	19	145	1.5 (3.4)
		3.8 (150)	20	165	1.8 (4.0)
		5.1 (200)	21	200	2.5 (5.4)
Spray Transfer 90% Ar/10% CO ₂	12-19 (1/2-3/4)	8.9 (350)	27	285	4.2 (9.2)
		12.1 (475)	30	335	5.7 (12.5)
		12.7 (500)	30	340	6.0 (13.2)
0.052 in (1.3 mm), DC+					
Spray Transfer 90% Ar/10% CO ₂	12-19 (1/2-3/4)	7.6 (300)	30	300	4.8 (10.7)
		8.1 (320)	30	320	5.2 (11.5)
		12.3 (485)	32	430	7.8 (17.1)
1/16 in (1.6 mm), DC+					
Spray Transfer 90% Ar/10% CO ₂	12-25 (1/2-1)	5.3 (210)	27	325	4.8 (10.7)
		6.0 (235)	28	350	5.4 (12.0)
		7.4 (290)	29	430	6.7 (14.8)

⁽¹⁾Typical all weld metal. ⁽²⁾Measured with 0.2% offset. ⁽³⁾See test results disclaimer. ⁽⁴⁾Copper due to any coating on the electrode plus the copper content of the filler metal itself shall not exceed the stated 0.50% max. ⁽⁵⁾CTWD (Contact Tip to Work Distance). Subtract 1/4 in (6.4 mm) to calculate Electrical Stickout. ⁽⁶⁾Procedures in these areas are procedures for short circuiting mode using 100% CO₂. When using 75% Argon, 25% CO₂, for short circuit transfer, reduce voltage by 1 to 2 volts.

SUPERARC® L-59®

Mild Steel, Copper Coated · AWS ER70S-6



KEY FEATURES

- Engineered alloy system enhances silicon island management
- Minimal spatter
- Copper coating provides superior arc-starting characteristics for long contact tip life
- Fast travel speeds
- MicroGuard® Ultra provides superior feeding and arc stability

WELDING POSITIONS

All

SHIELDING GAS

100% CO₂
 75-95% Argon / Balance CO₂
 95-98% Argon / Balance O₂
 Flow Rate: 30 - 50 CFH

CONFORMANCES

AWS A5.18: ER70S-6
ABS - Part 2: 3YSA H5
CWB/CSA W48: B-G 49A 3 C1 S6 [B-G 49A 3 C G6]
DNV - 2.9: III Y40MS H5
Lloyd's Register - Chapter 11: 3YS H5
BV - Chapter 5: SA3YHHH
ISO 14341-A: G 42 3 C1 3Si1 G 46 4 M21 3Si1 G 42 4 M20 3Si1
ISO 14341-B: G 49A 3 C1 S6

TYPICAL APPLICATIONS

- Robotic or hard automation
- Automotive
- Pipeline & Offshore
- Pressure vessels
- Heavy fabrication
- Alternative to metal-cored wire

DIAMETERS / PACKAGING

Diameter in (mm)	33 lb (14.9 kg) Plastic Spool	44 lb (20 kg) Fiber Spool	44 lb (20 kg) Steel Spool	60 lb (27.2 kg) Fiber Spool	500 lb (227 kg) Accu-Pak® Box
0.035 (0.9)	ED034270	ED033033	ED032366		ED032894
0.040 (1.0)					ED032895
0.045 (1.1)	ED034271		ED032367		ED032896
0.052 (1.3)	ED034272	ED034430*	ED032368	ED032814	ED032897
1/16 (1.6)	ED034356	ED036220**	ED032968		
Diameter in (mm)	500 lb (227 kg) Infinity-Pak®	900 lb (408 kg) Accu-Pak® Box	1000 lb (454 kg) Infinity-Pak®	1000 lb (454 kg) Accu-Pak® Box	1000 lb (454 kg) Precise-Trak® Reel
0.035 (0.9)	ED034402	ED032861			
0.040 (1.0)					
0.045 (1.1)			ED033215	ED032863	ED032808
0.052 (1.3)				ED032864, ED034431*	ED032809
1/16 (1.6)				ED032865	

*Buy America Product **Tested Material

MECHANICAL PROPERTIES⁽¹⁾ – As Required per AWS A5.18

	Yield Strength ⁽²⁾ MPa (ksi)	Tensile Strength MPa (ksi)	Elongation %	Charpy V-Notch J (ft-lbf)	
				@ -29°C [-20°F]	@ -40°C [-40°F]
Requirements - AWS ER70S-6 As-Welded with 100% CO ₂	400 [58] min	485 [70] min	22 min	27 [20] min	Not Specified
Typical Results⁽³⁾ As-Welded with 100% CO ₂	455 [66]	565 [82]	28	71 [52]	53 [39]
As-Welded with 75% Ar/25% CO ₂	485 [70]	595 [86]	25	56 [41]	53 [39]
As-Welded with 90% Ar/10% CO ₂	460 [67]	570 [83]	25	75 [55]	65 [48]

WIRE COMPOSITION – As Required per AWS A5.18

	%C	%Mn	%Si	%S	%P
Requirements - AWS ER70S-6	0.06-0.15	1.40-1.85	0.80-1.15	0.035 max	0.025 max
	%Cu ⁽⁴⁾	%Ni	%Cr	%Mo	%V
Requirements - AWS ER70S-6	0.50 max	0.15 max	0.15 max	0.15 max	0.03 max

TYPICAL OPERATING PROCEDURES

Diameter, Polarity Shielding Gas	CTWD ⁽⁵⁾ mm (in)	Wire Feed Speed m/min (in/min)	Voltage (volts)	Approx. Current (amps)	Melt-Off Rate kg/hr (lb/hr)
0.035 in (0.9 mm), DC+					
Short Circuit Transfer 75% Ar/25% CO ₂ ⁽⁶⁾	12 (1/2)	2.5 [100]	17	80	0.7 [1.6]
		3.8 [150]	18	120	1.1 [2.4]
		6.4 [250]	20	175	1.8 [4.0]
Spray Transfer 90% Ar/10% CO ₂	19 (3/4)	9.5 [375]	23	195	2.7 [6.0]
		12.7 [500]	29	230	3.6 [8.0]
		15.2 [600]	30	275	4.4 [9.6]
0.045 in (1.1 mm), DC+					
Short Circuit Transfer 75% Ar/25% CO ₂ ⁽⁶⁾	12 (1/2)	3.2 [125]	18	145	1.5 [3.4]
		3.8 [150]	19	165	1.8 [4.0]
		5.1 [200]	20	200	2.4 [5.4]
Spray Transfer 90% Ar/10% CO ₂	19 (3/4)	8.9 [350]	27	285	4.2 [9.2]
		12.1 [475]	30	335	5.7 [12.5]
		12.7 [500]	30	340	6.0 [13.2]
0.052 in (1.3 mm), DC+					
Spray Transfer 90% Ar/10% CO ₂	19 (3/4)	7.6 [300]	30	300	4.8 [10.6]
		8.1 [320]	30	320	5.2 [11.5]
		12.3 [485]	32	430	7.8 [17.1]
1/16 in (1.6 mm), DC+					
Spray Transfer 90% Ar/10% CO ₂	19 (3/4)	5.3 [210]	25	325	4.8 [10.7]
		6.0 [235]	27	350	5.4 [12.0]
		7.4 [290]	28	430	6.7 [14.8]

⁽¹⁾Typical all weld metal. ⁽²⁾Measured with 0.2% offset. ⁽³⁾See test results disclaimer. ⁽⁴⁾Copper due to any coating on the electrode plus the copper content of the filler metal itself, shall not exceed the stated 0.50% max. ⁽⁵⁾CTWD (Contact Tip to Work Distance). Subtract 1/4 in (6.4 mm) to calculate Electrical Stickout. ⁽⁶⁾Procedures in these areas are procedures for short circuiting mode using 75% Argon, 25% CO₂. NOTE: For 100% CO₂ procedures, add 1 to 2 volts for short circuit transfer and 2 to 3 volts for globular transfer.

SUPERARC® XLS

Mild Steel, Copper Coated ■ ISO 14341-A G 42 3 M20 Z

KEY FEATURES

- Minimize surface silicates for exceptionally clean weld surface
- Reduced silicates for improved paint adhesion and increased corrosion resistance
- Microguard® Ultra surface treatment for consistent, stable arc performance with little to no weld spatter
- Optimized for use with Rapid X® LS mode to lower silicate island formation and spatter generation

WELDING POSITIONS

Flat & Horizontal

CONFORMANCES

ISO 14341-A

G 42 3 M20 Z

TYPICAL APPLICATIONS

- Fillet and lap welds on thin material, including but not limited to automotive frames, chassis and suspension components
- Designed specifically for high speed, single pass applications

SHIELDING GAS

90% Argon / 10% CO₂

80% Argon / 20% CO₂

Flow rate: 40-50 CFH

DIAMETERS / PACKAGING

Diameter in mm	44 lb (20 kg) Fiber Spool	500 lb (227 kg) Accu-Pak® Box	1000 lb (454 kg) Accu-Pak® Box
0.047 (1.2)	ED037556		ED037555
0.045 (1.1)	ED037698		ED037697
0.040 (1.0)	ED037829		ED037828
0.035 (0.9)	ED037831	ED037832	

MECHANICAL PROPERTIES⁽¹⁾

	Yield Strength ⁽²⁾ MPa (ksi)	Tensile Strength MPa (ksi)	Elongation %	Charpy V-Notch J (ft•lbf) @ -30 °C (-20 °F)
Requirements ISO 14341-A-G 42 3 M20 Z	420 (61)	500-640 (73-93)	20	47 (35)
Typical Results⁽³⁾ As-Welded with 90% Argon / 10% CO ₂	446 (65)	524-545 (76-79)	25	110-172 (81-127)

WIRE COMPOSITION

	%C	%Mn	%Si	%S	%P	%Cu (Total) ⁽⁴⁾	%B
Requirements ISO 14341-A-G 42 3 M20 Z	—	—	—	—	—	—	—
Typical Results⁽³⁾	0.06-0.10	1.4-1.8	≤ 0.20	≤ 0.02	≤ 0.02	≤ 0.25	0.002-0.005

⁽¹⁾Typical all weld metal. ⁽²⁾Measured with 0.2% offset. ⁽³⁾See test results disclaimer. ⁽⁴⁾Copper due to any coating on the electrode plus the copper content of the filler metal itself.

TYPICAL OPERATING PROCEDURES

Diameter, Polarity Shielding Gas	CTWD ⁽⁵⁾ mm (in)	Wire Feed Speed m/min (in/min)	Voltage (volts)	Approx. Current (amps)	Melt-Off Rate kg/hr (lb/hr)
0.035" (0.9 mm), DC+					
Spray Transfer 80% Ar, 20% CO ₂	16 (5/8)	6.4 (250)	23	100	1.9 (4.1)
		8.9 (350)	25	140	2.6 (5.8)
		12.7 (500)	27	180	3.9 (8.5)
		16.5 (650)	29	220	5.1 (11.3)
Spray Transfer 90% Ar, 10% CO ₂	16 (5/8)	6.4 (250)	24	100	1.9 (4.2)
		8.9 (350)	26	140	2.6 (5.8)
		12.7 (500)	28	180	3.9 (8.5)
		16.5 (650)	30	220	4.9 (10.9)
0.040" (1.0 mm), DC+					
Spray Transfer 80% Ar, 20% CO ₂	16 (5/8)	5.6 (220)	23	105	2.1 (4.6)
		8.9 (350)	26	170	3.3 (7.3)
		11.4 (450)	28	210	4.2 (9.3)
		15.2 (600)	30	260	5.9 (13.1)
Spray Transfer 90% Ar, 10% CO ₂	16 (5/8)	5.6 (220)	22	105	2.2 (4.8)
		8.9 (350)	25	170	3.3 (7.3)
		11.4 (450)	27	210	4.2 (9.3)
		15.2 (600)	29	260	5.7 (12.6)
0.045" (1.1 mm), DC+					
Spray Transfer 80% Ar, 20% CO ₂	19 (3/4)	3.8 (150)	24	120	2.0 (4.5)
		8.9 (350)	29	265	4.7 (10.3)
		14.0 (550)	32	370	7.3 (16.2)
Spray Transfer 90% Ar, 10% CO ₂	19 (3/4)	3.8 (150)	23	125	2.0 (4.5)
		8.9 (350)	28	255	4.7 (10.4)
		14.0 (550)	32	360	7.3 (16.0)
0.047" (1.2 mm), DC+					
Spray Transfer 80% Ar, 20% CO ₂	19 (3/4)	3.8 (150)	24	120	2.0 (4.5)
		8.9 (350)	29	265	4.7 (10.3)
		14.0 (550)	32	370	7.3 (16.2)
Spray Transfer 90% Ar, 10% CO ₂	19 (3/4)	3.8 (150)	23	125	2.0 (4.5)
		8.9 (350)	28	255	4.7 (10.4)
		14.0 (550)	32	360	7.3 (16.0)

⁽⁵⁾CTWD (Contact Tip to Work Distance). Subtract 1/4 in. (6.4 mm) to calculate electrode stickout.

SUPERARC® G4Si1

Mild Steel, Copper Coated · AWS ER70S-6

KEY FEATURES

- Higher strength than typical ER70S-6 products to enable conformance to both AWS and EN ISO standards
- Excellent toe-wetting provides optimal bead appearance
- Copper coating provides superior arc-starting characteristics for long contact tip life
- Supports short-circuiting, globular, axial spray and pulsed spray transfer
- Microguard® Ultra provides superior feeding and arc stability

WELDING POSITIONS

All

SHIELDING GAS

100% CO₂

85-90% Argon / Balance CO₂

Flow Rate: 30-50 CFH

CONFORMANCES

AWS A5.18: ER70S-6

ISO 14341-A: G 46 3 C1 4Si1 G 50 5 M20 4Si1

ISO 14341-B: G 49A 2 C1 S3

TYPICAL APPLICATIONS

- Automotive Repair
- Automotive Components
- Robotic or Hard Automation

DIAMETERS/PACKAGING

Diameter in (mm)	500 lb (227 kg) Accu-Pak® Box	1000 lb (454 kg) Accu-Pak® Box
0.045 (1.1)	ED037131	ED037156

MECHANICAL PROPERTIES⁽¹⁾

Charpy V-Notch J (ft-lbf)	Yield Strength ⁽²⁾ ksi (MPa)	Tensile Strength ksi (MPa)	Elongation %	Charpy V-Notch J (ft-lbf)		
				@ -29°C [-20°F]	@ -30°C [-22°F]	@ -50°C [-58°F]
Requirements – AWS A5.18 ER70S-6, As-Welded with 100% CO ₂	400 [58] min	485 [70] min	22 min	27 [20] min	-	-
Typical Results⁽³⁾ – AWS A5.18 As-Welded w/100% CO ₂	470 [68]	590 [85]	25	56 [41]	-	-
Requirements – EN ISO 14341-A G 46 3 C1 G4Si1, As-Welded with 100% CO ₂ G 50 5 M20 G4Si1, As-Welded with 85%Argon/Balance CO ₂	460 [67] min 500 [73] min	530-680 [77-99] 560-720 [81-104]	20 min. 18 min.	- -	47 [35] min. -	- 47 [35] min
Typical Results⁽³⁾ – EN ISO 14341-A As-Welded with 100% CO ₂ As-Welded with 85% Argon/Balance CO ₂	490 [71] 520 [75]	600 [87] 620 [90]	24 23	- -	90 [66] -	- 81 [60]

WIRE COMPOSITION

	%C	%Mn	%Si	%S	%P
Requirements - AWS A5.18, ER70S-6	0.06-0.15	1.40-1.85	0.80-1.15	0.035 max.	0.025 max.
Requirements - EN ISO 14341-A, G4Si1	0.06-0.14	1.60-1.90	0.80-1.20	0.025 max.	0.025 max.
Typical Results ^(b)	0.09	1.67	0.87	0.006-0.010	0.004-0.010
	%CR	%Ni	%Mo	%V	%Cu (Total) ^(d)
Requirements - AWS A5.18, ER70S-6	0.15 max.	0.15 max.	0.15 max.	0.03 max.	0.50 max.
Requirements - EN ISO 14341-A, G4Si1	0.15 max.	0.15 max.	0.15 max.	0.03 max.	0.35 max.
Typical Results ^(b)	0.02	0.02	<0.01	<0.01	0.20

TYPICAL OPERATING PROCEDURES

Diameter, Polarity, Shielding Gas	CTWD ^(b) mm (in)	Wire Feed Speed m/min (in/min)	Voltage (Volts)	Approx. Current (amps)	Melt-Off Rate kg/hr (lb/hr)
0.045 in (1.1 mm), DC+					
Short Circuit Transfer ^(c) 100% CO ₂	12-19 (1/2-3/4)	3.2 (125)	19	145	1.5 (3.4)
		3.8 (150)	20	165	1.8 (4.0)
		5.1 (200)	21	200	2.5 (5.4)
Spray Transfer 85% Argon/15% CO ₂	12-19 (1/2-3/4)	8.9 (350)	27	285	4.2 (9.2)
		12.1 (475)	30	335	5.7 (12.5)
		12.7 (500)	30	340	6.0 (13.2)

⁽¹⁾ Typical all weld metal. ⁽²⁾ Measured with 0.2% offset. ⁽³⁾ See test results disclaimer. ⁽⁴⁾ Copper due to any coating on the electrode plus the copper content of the filler metal itself, shall not exceed the stated 0.50% max.
⁽⁵⁾ CTWD (Contact Tip to Work Distance). Subtract 1/4 in (6.4 mm) to calculate Electrical Stickout. ⁽⁶⁾ Procedures in these areas are procedures for short circuiting mode using 100% CO₂. When using 75% Argon, 25% CO₂ for short circuit transfer, reduce voltage by 1 to 2 volts

MUREMATIC® S3

Mild Steel, Copper Coated · AWS ER70S-3

KEY FEATURES

- Copper coating provides superior arc-starting characteristics for long contact tip life
- Manganese and silicon content of an S-3 wire can tolerate low levels of mill scale on the base material
- MicroGuard® surface treatment provides superior feeding
- Manufactured in the USA

SHIELDING GAS

100% CO₂
 75-95% Ar/Balance CO₂
 95-98% Ar/Balance CO₂
 Flow Rate: 30 - 50 CFH

CONFORMANCES

AWS A5 18: ER70S-3
ASME SFA-A5.18: ER70S-3

TYPICAL APPLICATIONS

- Industrial
- Farming
- Construction
- Mining equipment
- For welding on base material that is clean or has light mill scale
- General fabrication

WELDING POSITIONS

All

DIAMETERS / PACKAGING

Diameter in (mm)	44 lb (20 kg) Steel Spool	44 lb (20 kg) Fiber Spool	60 lb (27 kg) Fiber Spool	500 lb (227 kg) Accu-Trak® Drum	1000 lb (453 kg) Speed Feed® Drum	1000 lb (453 kg) Accu-Trak® Drum
0.035 (0.9)	EDM23347543	EDM23346593	EDM23346713	EDM23346783	EDM23346513	EDM23346573
0.045 (1.1)	EDM23347545	EDM23346595	EDM23346715	EDM23346785		EDM23346575
0.052 (1.3)						EDM23346576

MECHANICAL PROPERTIES⁽¹⁾ – As Required per AWS A5.18

	Yield Strength ⁽²⁾ MPa (ksi)	Tensile Strength MPa (ksi)	Elongation %	Charpy V-Notch J (ft-lbf) @ 0°F (-18°C)
Requirements - AWS ER70S-3	58,000 (400) min	70,000 (483) min	22 min	27 [20] min
Typical Results ⁽³⁾	64,900 (447)	81,000 (559)	24	67 (91)

WIRE COMPOSITION⁽¹⁾ – As Required per AWS A5.18

	%C	%Mn	%Si	%P	%S	%Ni	%Cr	%Mo	%V	Cu (total)
Requirements - AWS ER70S-3	0.06-0.15	0.90-1.40	0.45-0.75	0.025 max	0.035 max	0.15 max	0.15 max	0.15 max	0.03 max	0.50 max
Typical Results ⁽³⁾ - As-Welded	0.10	1.23	0.56	0.014	0.008	0.04	0.03	0.01	-	0.17

TYPICAL OPERATING PROCEDURES

Diameter, Polarity Shielding Gas	Wire Feed Speed in/min (mm/min)	Voltage (volts)	Approx. Current (amps)	Melt-Off Rate lb/hr (kg/hr)
0.035 in (0.9 mm), DC+				
Short Circuit Transfer - 100% CO ₂	100-250 [2.5-6.4]	18-22	80-175	1.6-4.0 [0.7-1.8]
Spray Transfer - 90% Ar/10% CO ₂	375-600 [9.5-15.2]	23-30	195-275	6.0-9.6 [2.7-4.4]
0.045 in (1.1 mm), DC+				
Short Circuit Transfer - 100% CO ₂	125-200 [3.2-5.0]	19-21	145-200	3.4-5.4 [1.5-2.5]
Spray Transfer - 90% Ar/10% CO ₂	350-500 [8.9-12.7]	27-30	285-340	9.2-13.2 [4.2-6.0]
0.052 in (1.3 mm), DC+				
Spray Transfer - 90% Ar/10% CO ₂	300-485 [7.6-12.3]	30-32	300-430	10.6-17.1 [4.8-7.8]
1/16 in (1.6 mm), DC+				
Spray Transfer - 90% Ar/10% CO ₂	210-290 [5.3-7.4]	25-28	325-430	10.7-14.8 [4.8-6.7]

⁽¹⁾Typical all weld metal. ⁽²⁾Measured with 0.2% offset. ⁽³⁾See test results disclaimer

MUREMATIC® S4+

Mild Steel, Copper Coated Wire • AWS ER70S-4

KEY FEATURES

- Highly resistant to copper flaking which can clog liners and contact tips
- Copper coating provides superior arc-starting characteristics, for long contact tip life
- MicroGuard® surface treatment provides superior feeding
- Manufactured in the USA

WELDING POSITIONS

All

SHIELDING GAS

100% CO₂
75-95% Ar/Balance CO₂
95-98% Ar/Balance CO₂
Flow Rate: 30 - 50 CFH

DIAMETERS / PACKAGING

Diameter in (mm)	30 lb (13 kg) Spool	44 lb (20 kg) Steel Spool	44 lb (20 kg) Fiber Spool	60 lb (27 kg) Fiber Spool	500 lb (227 kg) Accu-Trak® Drum	1000 lb (453 kg) Accu-Trak® Drum
0.035 (0.9)	EDM23346353	EDM23347343	EDM23346393	EDM23346313	EDM23346383	EDM23346173
0.045 (1.1)	EDM23346355		EDM23346395	EDM23346315	EDM23346385	
0.052 (1.3)		EDM23346396				

CONFORMANCES

AWS A5 18: ER70S-4

ASME SFA-A5.18: ER70S-4

TYPICAL APPLICATIONS

- Applications which require greater cleaning action through increased levels of silicon and manganese compared to the levels provided by a typical ER70S-3 wire
- Industrial
- Farming
- Construction
- Mining equipment
- For welding on base material that is clean or has light mill scale
- General fabrication

MECHANICAL PROPERTIES⁽¹⁾ – As Required per AWS A5.18

	Yield Strength ⁽²⁾ MPa (ksi)	Tensile Strength MPa (ksi)	Elongation %	Charpy V-Notch J [ft-lbf] @ -20°F [-29°C]
Requirements - AWS ER70S-4	58,000 (400) min	70,000 (483) min	22 min	Not Specified
Typical Results ⁽³⁾	64,000 (441)	79,000 (555)	28	58 (79)

WIRE COMPOSITION – As Required per AWS A5.18

	%C	%Mn	%Si	%P	%S	%Ni	%Cr	%Mo	%V	Cu (total)
Requirements - AWS ER70S-4	0.06-0.15	1.00-1.50	0.65-0.85	0.025 max	0.035 max	0.15 max	0.15 max	0.15 max	0.03 max	0.50 max
Typical Results ⁽³⁾ - As-Welded	0.09	1.28	0.73	0.018	0.010	0.06	0.05	0.02	-	0.26

TYPICAL OPERATING PROCEDURES

Diameter, Polarity Shielding Gas	Wire Feed Speed in/min (mm/min)	Voltage (volts)	Approx. Current (amps)	Melt-Off Rate lb/hr (kg/hr)
0.035 in (0.9 mm), DC+				
Short Circuit Transfer - 100% CO ₂	100-250 [2.5-6.4]	18-22	80-175	1.6-4.0 [0.7-1.8]
Spray Transfer - 90% Ar/10% CO ₂	375-600 [9.5-15.2]	23-30	195-275	6.0-9.6 [2.7-4.4]
0.045 in (1.1 mm), DC+				
Short Circuit Transfer - 100% CO ₂	125-200 [3.2-5.0]	19-21	145-200	3.4-5.4 [1.5-2.5]
Spray Transfer - 90% Ar/10% CO ₂	350-500 [8.9-12.7]	27-30	285-340	9.2-13.2 [4.2-6.0]
0.052 in (1.3 mm), DC+				
Spray Transfer - 90% Ar/10% CO ₂	300-485 [7.6-12.3]	30-32	300-430	10.6-17.1 [4.8-7.8]
1/16 in (1.6 mm), DC+				
Spray Transfer - 90% Ar/10% CO ₂	210-290 [5.3-7.4]	25-28	325-430	10.7-14.8 [4.8-6.7]

⁽¹⁾Typical all weld metal. ⁽²⁾Measured with 0.2% offset. ⁽³⁾See test results disclaimer

MUREMATIC® S6

Mild Steel, Copper Coated Wire • AWS ER70S-6

KEY FEATURES

- Excellent spatter control and bead profile
- MicroGuard® surface treatment provides superior feeding
- Copper coating provides superior arc-starting characteristics for long contact tip life
- Manufactured in the USA

WELDING POSITIONS

All

SHIELDING GAS

100% CO₂
 75-95% Ar/Balance CO₂
 95-98% Ar/Balance CO₂
 Flow Rate: 30 - 50 CFH

DIAMETERS / PACKAGING

Diameter in (mm)	30 lb (13 kg) Spool	44 lb (20 kg) Steel Spool	44 lb (20 kg) Fiber Spool	60 lb (27 kg) Fiber Spool	60 lb (27 kg) Coil	500 lb (227 kg) Accu-Trak® Drum	1000 lb (453 kg) Accu-Trak® Drum
0.030 (0.8)	EDM23346852					EDM23346883	EDM23346673
0.035 (0.9)	EDM23346853	EDM23347843	EDM23346893			EDM23346885	EDM23346675
0.045 (1.1)	EDM23346855	EDM23347845	EDM23346895	EDM23347815	EDM23346875	EDM23346886	EDM23346676

MECHANICAL PROPERTIES – As Required per AWS A5.18

	Yield Strength ^(a) MPa (ksi)	Tensile Strength MPa (ksi)	Elongation %	Charpy V-Notch J [ft-lbf] @ -20°F (-29°C)
Requirements - AWS ER70S-6	58,000 (400) min	70,000 (483) min	22 min	20 (27) min
Typical Results ^(a)	67,000 (462)	82,000 (565)	27	52 (71)

WIRE COMPOSITION^(a) – As Required per AWS A5.18

	%C	%Mn	%Si	%P	%S	%Ni	%Cr	%Mo	%V	Cu (total)
Requirements - AWS ER70S-6	0.06-0.15	1.40-1.85	0.80-1.15	0.025 max	0.035 max	0.15 max	0.15 max	0.15 max	0.03 max	0.50 max
Typical Results ^(a) - As-Welded	0.07	1.44	0.73	0.011	0.007	0.02	0.02	0.01	-	0.21

TYPICAL OPERATING PROCEDURES

Diameter, Polarity Shielding Gas	Wire Feed Speed in/min (mm/min)	Voltage (volts)	Approx. Current (amps)	Melt-Off Rate lb/hr (kg/hr)
0.035 in (0.9 mm), DC+				
Short Circuit Transfer - 100% CO ₂	100-250 [2.5-6.4]	18-22	80-175	1.6-4.0 [0.7-1.8]
Spray Transfer - 90% Ar/10% CO ₂	375-600 [9.5-15.2]	23-30	195-275	6.0-9.6 [2.7-4.4]
0.045 in (1.1 mm), DC+				
Short Circuit Transfer - 100% CO ₂	125-200 [3.2-5.0]	19-21	145-200	3.4-5.4 [1.5-2.5]
Spray Transfer - 90% Ar/10% CO ₂	350-500 [8.9-12.7]	27-30	285-340	9.2-13.2 [4.2-6.0]
0.052 in (1.3 mm), DC+				
Spray Transfer - 90% Ar/10% CO ₂	300-485 [7.6-12.3]	30-32	300-430	10.6-17.1 [4.8-7.8]
1/16 in (1.6 mm), DC+				
Spray Transfer - 90% Ar/10% CO ₂	210-290 [5.3-7.4]	25-28	325-430	10.7-14.8 [4.8-6.7]

^(a)Typical all weld metal. ^(b)Measured with 0.2% offset. ^(c)See test results disclaimer

CONFORMANCES

AWS A5 18:	ER70S-6
ASME SFA-A5.18:	ER70S-6
CWB/CSA W48:	B-G 49A 3 C1 S6
ISO 14341-B:	G 49A 3 C1 S6

TYPICAL APPLICATIONS

- Applications which require greater cleaning action through increased levels of silicon and manganese compared to the levels provided by a typical ER70S-3 or ER70S-6 wire
- Industrial
- Farming
- Construction
- Mining equipment
- For welding on metals with a medium-to-high presence of mill scale

LINCOLN® S6

Mild Steel, Copper Coated

KEY FEATURES

- ER70S-6 MIG wire for general fabrication applications
- Mild steel, copper coated wire offers low spatter and a smooth arc
- Available on spools and drum in both 0.035 in. (0.9 mm) or 0.045 in. (1.1 mm) diameters

WELDING POSITIONS

All

CONFORMANCES

AWS A5.18, ASME ER70S-6
SFA-A5.18:

TYPICAL APPLICATIONS

- General Fabrication

SHIELDING GAS

100% CO₂
75-95% Argon / balance CO₂
Flow Rate: 30 - 50 CFH

DIAMETERS / PACKAGING

Diameter in (mm)	2,376 lb (1078 kg) Pallet of 33 lb (15 kg) Spools	1,000 lb (454 kg) Pallet of 500 lb (227 kg) Accu-Trak® Drum
0.035 (0.9)	ED037837	ED038010
0.045 (1.1)	ED037838	ED038011

MECHANICAL PROPERTIES⁽¹⁾

	Yield Strength ⁽²⁾ MPa (ksi)	Tensile Strength MPa (ksi)	Elongation %	Charpy V-Notch J (ft-lbf) @ -29°C (-20°F)
Requirements AWS A5.18: ER70S-6	400 (58) min	480 (70) min.	22 min	27 (20) min
Typical Results⁽³⁾ As-Welded with 100%CO ₂ As-Welded with 90%Ar/10%CO ₂	460 (67) 480 (70)	550 (80) 560 (81)	26 26	70 (50) 90 (65)

WIRE COMPOSITION

	%C	%Mn	%Si	%S	%P	%Ni	%Cr	%Mo	%V	%Cu (Total) ⁽⁴⁾
Requirements AWS A5.18: ER70S-6	0.06 - 0.15	1.40 - 1.85	0.80 - 1.15	0.035 max.	0.025 max.	0.15 max.	0.15 max.	0.15 max.	0.03 max.	0.50 max.
Typical Results⁽³⁾	0.08	1.50	0.85	0.010	0.008	0.04	0.04	0.01	<0.01	0.15

⁽¹⁾Typical all weld metal. ⁽²⁾Measured with 0.2% offset. ⁽³⁾See test results disclaimer ⁽⁴⁾Copper due to any coating on the electrode plus the copper content of the filler metal itself, shall not exceed the stated 0.50% max. ⁽⁵⁾CTWD (Contact Tip to Work Distance). Subtract 1/4 in (6.4 mm) to calculate Electrical Stickout. ⁽⁶⁾Procedures in these areas are procedures for short circuiting mode using 100% CO₂. When using 75% Argon, 25% CO₂, for short circuit transfer, reduce voltage by 1 to 2 volts.

TYPICAL OPERATING PROCEDURES

Diameter, Polarity in (mm)	CTWD ⁽⁵⁾ in (mm)	Wire Feed Speed m/min (in/min)	Approx. Voltage (Volts)	Approx. Current (Amps)	Melt-Off Rate kg/hr (lb/hr)
0.035 (0.9), DC+					
Short Circuit Transfer 100% CO ₂ ⁽⁶⁾	9 - 12 (3/8 - 1/2)	2.5 - 7.5 (100 - 300)	18 - 23	80 - 175	
Spray Transfer 90% Ar / 10% CO ₂	12 - 19 (1/2 - 3/4)	8.0 - 15.0 (315 - 590)	23 - 30	190 - 270	
0.045 (1.1), DC+					
Short Circuit Transfer 100% CO ₂ ⁽⁶⁾	12 - 19 (1/2 - 3/4)	3.5 - 7.0 (135 - 275)	18-25	150 - 210	
Spray Transfer 90% Ar / 10% CO ₂	12 - 19 (1/2 - 3/4)	9.0 - 13.0 (350 - 510)	26-35	280 - 350	

⁽¹⁾Typical all weld metal. ⁽²⁾Measured with 0.2% offset. ⁽³⁾See test results disclaimer. ⁽⁴⁾Copper due to any coating on the electrode plus the copper content of the filler metal itself, shall not exceed the stated 0.50% max. ⁽⁵⁾CTWD (Contact Tip to Work Distance). Subtract 1/4 in (6.4 mm) to calculate Electrical Stickout. ⁽⁶⁾Procedures in these areas are procedures for short circuiting mode using 100% CO₂. When using 75% Argon, 25% CO₂ for short circuit transfer, reduce voltage by 1 to 2 volts.

1CRMO

Low Alloy Steel · AWS ER80S-G

KEY FEATURES

- Modified ER80S-B2 wire optimized for GMAW
- Developed for 1 1/4 Cr-1/2Mo steels
- Designed for prolonged elevated service temperature up to 550°C
- Superior feedability

WELDING POSITIONS

All

SHIELDING GAS

75-90% Ar/Balance CO₂
Flow Rate: 30-50 CFH

CONFORMANCES

AWS 5.28: ER80S-G
BS EN ISO 21952-A CrMo1Si

TYPICAL APPLICATIONS

- Steam Generating Power Plant
- Process Piping
- Coal Liquefaction Plant
- NH₃ Pressure Vessels
- Offshore

DIAMETERS / PACKAGING

Diameter mm (in)	15 kg (33.1 lb) Spool
1.2 (0.045)	M1CRMO-12

MECHANICAL PROPERTIES⁽¹⁾ – As Required per AWS A5.28

	Yield Strength ⁽²⁾ MPa (ksi)	Tensile Strength MPa (ksi)	Elongation %	Charpy V-Notch J (ft-lbf) @ -10°C (14°F)	Hardness HV
Requirements AWS ER80S-G	470 (68) min	550 (80) min	19 min	Not Specified	-
Typical Results⁽⁴⁾	480 (690)	590 (85)	26	>115	195

DEPOSIT COMPOSITION⁽¹⁾ – As Required per AWS A5.28

	%C	%Mn	%Si	%S	%P
Requirements AWS ER80S-G	0.08-0.14	0.8-1.2	0.5-0.8	0.02 max	0.02 max
Typical Results⁽³⁾	0.1	1	0.6	0.01	0.015
	%Cr	%Ni	%Mo	%Cu	
Requirements AWS ER80S-G	0.9-1.3	-	0.45-0.65	0.4 max	
Typical Results⁽³⁾	1.2	<0.1	0.5	0.1	

TYPICAL OPERATING PROCEDURES

Diameter mm (in)	Polarity	Amperage	Voltage
1.2 (0.045)	DC+	150-280A	18-26V

⁽¹⁾ Typical all weld metal ⁽²⁾ Measured with 0.2% offset ⁽³⁾ See test results disclaimer ⁽⁴⁾ PWHT 690 °C/4h (AWS= 1h)

2CRMO

Low Alloy Steel · AWS ER90S-G

KEY FEATURES

- Designed for high strength and improved hardness to resist metal-to-metal wear
- Developed to provide corrosion resistance to Sulphur bearing crude oil
- Superior feedability

WELDING POSITIONS

All

SHIELDING GAS

95% Argon / 5% CO₂

CONFORMANCES

AWS 5.28: ER90S-G
BS EN ISO 21952-A CrMo2Si

TYPICAL APPLICATIONS

- Steam Generating Power Plant
- Piping
- Coal Liquefaction Plant
- NH₃ Pressure Vessels

DIAMETERS / PACKAGING

Diameter mm (in)	15 kg (33.1 lb) Spool
0.8 (0.035)	M2CRMO-08
1.2 (0.045)	M2CRMO-12

MECHANICAL PROPERTIES⁽¹⁾ – As Required per AWS A5.28

	Yield Strength ⁽²⁾ MPa (ksi)	Tensile Strength MPa (ksi)	Elongation %	Charpy V-Notch J (ft-lbf) @ -10°C (14°F)	Hardness HV
Requirements AWS ER90S-G	540 (78) min	620 (90) min	17 min	-	-
Typical Results⁽³⁾	540 (78)	655 (95)	23	>95	220

DEPOSIT COMPOSITION⁽¹⁾ – As Required per AWS A5.28

	%C	%Mn	%Si	%S	%P
Requirements AWS ER90S-G	0.06-0.12	0.80-1.20	0.50-0.80	0.02 max	0.02 max
Typical Results⁽³⁾	0.1	1	0.6	0.01	0.015
	%Cr	%Ni	%Mo	%Cu	
Requirements AWS ER90S-G	2.30-2.70	-	0.90-1.10	0.4 max	
Typical Results⁽³⁾	2.4	<0.1	1	0.15	

TYPICAL OPERATING PROCEDURES

Diameter mm (in)	Polarity	Amperage	Voltage
1.2 (0.045)	DC+	280A	26V

⁽¹⁾ Typical all weld metal ⁽²⁾ Measured with 0.2% offset ⁽³⁾ See test results disclaimer

TECHALLOY® 4130

Low Alloy Steel

KEY FEATURES

- High strength, low alloy
- Preheat and inter-pass temperature of 400°F [204.4°C] is required

WELDING POSITIONS

All

TYPICAL APPLICATIONS

- Joining steels of similar chemical composition
- Overlays where moderate hardness is required

SHIELDING GAS

75% Ar/ 25%CO₂
98% Ar/ 2% O₂

DIAMETERS / PACKAGING

Diameter in (mm)	MIG 33 lb (15 kg) Steel Spool
0.035 (0.9)	MG4130035659
0.045 (1.1)	MG4130045659
1/16 (1.6)	MG4130062659

MECHANICAL PROPERTIES⁽⁴⁾

	Yield Strength ⁽²⁾ MPa (ksi)	Tensile Strength MPa (ksi)	Elongation %
Typical Results ⁽³⁾	900 (130)	1,000 (145)	11

WIRE COMPOSITION⁽¹⁾

	%C	%Mn	%Si	%Fe	%Cr	%Mo	%Ni	%V
Typical Results ⁽³⁾	0.31	0.52	0.28	Balance	0.93	0.20	-	-

TYPICAL OPERATING PROCEDURES

Process	Diameter in (mm)	Voltage (volts)	Amperage	Gas
MIG – Spray Transfer	0.035 (0.9)	26.5-31	180-250	98% Ar / 2% O ₂
	0.045 (1.1)	28-32	300-380	
	1/16 (1.6)	28-32	350-400	
MIG – Short Circuit Transfer	0.035 (0.9)	22-26	150-175	75% Ar / 2% CO ₂
	0.045 (1.1)	23-26	175-215	

⁽¹⁾Typical deposit composition. ⁽²⁾Measured with 0.2% offset. ⁽³⁾See test results disclaimer. ⁽⁴⁾Quenched from 1,550 F (843 C) in oil and tempered at 1,050 ° F (565 ° C). Safety Data Sheets (SDS) are available on our website at www.lincolnelectric.com

SUPERARC® LA-75™

Low Alloy, Copper Coated · AWS ER80S-Ni1 & ENiK



KEY FEATURES

- Capable of producing weld deposits with 550 MPa (80 ksi) tensile strength
- High toughness at low temperatures with a nominal 1% Ni or less
- MicroGuard® Ultra provides superior feeding and arc stability
- Supports short-circuiting, globular, axial spray and pulsed spray transfer
- Copper coating provides superior arc-starting characteristics for long contact tip life

WELDING POSITIONS

All

SHIELDING GAS

90-95% Argon / Balance CO₂

95-98% Argon / Balance O₂

Flow Rate: 30 - 50 CFH

CONFORMANCES

AWS A5.28: ER80S-Ni1

CWB AWS A5.28: ER55S-Ni1 (ER80S-Ni1)

ISO 14171-B: G 55A 4 M13 SN2 SUN21

ISO 14341-B: G 55A 4 M13 SN2

TYPICAL APPLICATIONS

- ASTM A588 weathering steel requiring good atmospheric corrosion resistance
- NACE applications

DIAMETERS / PACKAGING

Diameter in (mm)	33 lb (15 kg) Steel Spool	44 lb (20 kg) Steel Spool
0.035 (0.9)	ED031415, ED033949**	
0.045 (1.1)	ED031416, ED034432*	
0.052 (1.3)		ED036509

*Buy America Product. **Q2 Tested Product.

MECHANICAL PROPERTIES⁽¹⁾ – As Required per AWS A5.28

	Yield Strength ⁽²⁾ MPa (ksi)	Tensile Strength MPa (ksi)	Elongation %	Charpy V-Notch J [ft-lbf]		
				@ -29°C [-20°F]	@ -45°C [-50°F]	@ -62°C [-80°F]
Requirements - AWS ER80S-Ni1 As-Welded with 98% Ar/2% O ₂	470 (68) min	550 (80) min	24 min	Not Specified	27 (20) min	Not Specified
Typical Results⁽³⁾						
As-Welded with 90% Ar/10% CO ₂	475 (69)	580 (84)	28	119 (88)	82 (60)	35 (26)
Stress Relieved 1 hr. @ 621°C (1150° F)	450 (65)	565 (82)	32	- -	127 (93)	112 (82)
As-Welded with 98% Ar/2% O ₂	490 (71)	580 (84)	30	- -	172 (127)	- -
Stress Relieved 1 hr. @ 621°C (1150° F)	420 (61)	540 (78)	31	- -	230 (170)	165 (122)

⁽¹⁾Typical all weld metal. ⁽²⁾Measured with 0.2% offset. ⁽³⁾See test results disclaimer.

WIRE COMPOSITION – As Required per AWS A5.28

	%C	%Mn	%Si	%Ni	%Cr
Requirements - AWS ER80S-Ni1	0.12 max	1.25 max	0.40-0.80	0.80-1.10	0.15 max
Typical Results⁽¹⁾	0.07-0.08	0.94-1.04	0.54-0.58	0.88-0.98	≤ 0.04
	%Mo	%S	%P	%V	%Cu (Total) ⁽⁴⁾
Requirements - AWS ER80S-Ni1	0.35 max	0.025 max	0.025 max	0.05 max	0.35 max
Typical Results⁽¹⁾	≤ 0.02	0.007 - 0.010	0.005 - 0.010	< 0.01	0.16 - 0.21

TYPICAL OPERATING PROCEDURES

Diameter, Polarity Shielding Gas	CTWD ⁽³⁾ mm (in)	Wire Feed Speed m/min (in/min)	Voltage (volts)	Approx. Current (amps)	Melt-Off Rate kg/hr (lb/hr)
0.035 in (0.9 mm), DC+					
Short Circuit Transfer 90% Ar/ 10% CO ₂	9-12 (3/8-1/2)	2.5 (100)	17	80	0.7 (1.6)
		3.8 (150)	18	120	1.1 (2.4)
		6.4 (250)	22	175	1.8 (4.0)
Spray Transfer 90% Ar/10% CO ₂	12-19 (1/2-3/4)	9.5 (375)	23	195	2.7 (6.0)
		12.7 (500)	29	230	3.6 (8.0)
		15.2 (600)	30	275	4.4 (9.6)
0.045 in (1.1 mm), DC+					
Short Circuit Transfer 90% Ar/ 10% CO ₂	12-19 (1/2-3/4)	3.2 (125)	19	145	1.5 (3.4)
		3.8 (150)	20	165	1.8 (4.0)
		5.1 (200)	21	200	2.4 (5.4)
Spray Transfer 90% Ar/10% CO ₂	12-19 (1/2-3/4)	8.9 (350)	27	285	4.2 (9.2)
		12.1 (475)	30	335	5.7 (12.5)
		12.7 (500)	30	340	6.0 (13.2)

⁽¹⁾Typical all weld metal. ⁽²⁾Measured with 0.2% offset. ⁽³⁾See test results disclaimer ⁽⁴⁾Copper due to any coating on the electrode plus the copper content of the filler metal itself, shall not exceed the stated 0.50% max. ⁽⁵⁾CTWD (Contact Tip to Work Distance). Subtract 1/4 in (6.4 mm) to calculate Electrical Stickout. NOTE: For 100% CO₂ procedures, add 1 to 2 volts for short circuit transfer and 2 to 3 volts for globular transfer.

SUPERARC® LA-90™

Low Alloy, Copper Coated · AWS ER80S-D2, ER90S-D2 & EA3K

KEY FEATURES

- Capable of producing weld deposits with 550 - 620 MPa (80 - 90 ksi) tensile strength
- Contains 0.50% molybdenum for strength after stress-relief
- MicroGuard® Ultra provides superior feeding and arc stability
- Supports short-circuiting, globular, axial spray and pulsed spray transfer
- Copper coating provides superior arc-starting characteristics for long contact tip life

WELDING POSITIONS

All

SHIELDING GAS

100% CO₂
95-98% Argon / Balance O₂
Flow Rate: 30 - 50 CFH

CONFORMANCES

AWS A5.28: ER80S-D2, ER90S-D2
CWB AWS A5.28: ER55S-D2 (ER80S-D2), ER62S-D2 (ER90S-D2)
ISO 16834-B G59A 3 C1 4M31, G62A 3 M13 4M31

TYPICAL APPLICATIONS

- Requirements for strength after stress relieving
- ASTM A182, A217, A234 and A335 high temperature service pipe, fittings, flanges and valves
- ASTM A336 pressure vessel forgings

DIAMETERS / PACKAGING

Diameter in (mm)	33 lb (15 kg) Steel Spool	44 lb (20 kg) Steel Spool	44 lb (20 kg) Fiber Spool	
0.035 (0.9)	ED031413	EDS30775	ED029546	
0.045 (1.1)	ED031414	EDS30776		
0.052 (1.3)		EDS30777		
1/16 (1.6)				
Diameter in (mm)	60 lb (27.2 kg) Coil	60 lb (27.2 kg) Fiber Spool	500 lb (227 kg) Accu-Trak® Drum	
0.035 (0.9)			EDS01372	
0.045 (1.1)		EDS01380	ED001378	
0.052 (1.3)			ED026627	
1/16 (1.6)	ED013999			
Diameter in (mm)	500 lb (227 kg) Accu-Pak® Box	1000 lb (454 kg) Accu-Trak® Drum	1000 lb (454 kg) Accu-Pak® Box	1000 lb (454 kg) Infinity-Pak®
0.035 (0.9)		EDS29590		
0.045 (1.1)	ED032919	ED029591	ED034436	
0.052 (1.3)	ED032920	EDS29592		ED034955
1/16 (1.6)				

MECHANICAL PROPERTIES⁽¹⁾ – As Required per AWS A5.28

	Yield Strength ⁽²⁾ MPa (ksi)	Tensile Strength MPa (ksi)	Elongation %	Charpy V-Notch J (ft·lbf)	
				@ -29°C [-20°F]	@ -40°C [-40°F]
Requirements - AWS ER80S-D2 As-Welded with 100% CO ₂	470 (68) min	550 (80) min	17 min	27 (20) min	Not Specified
AWS ER90S-D2 As-Welded with 95-99% Ar/Balance O ₂	540 (78) min	620 (90) min	17 min	27 (20) min	Not Specified
Typical Results⁽³⁾					
As-Welded with 100% CO ₂	560 (81)	655 (95)	23	36 (26)	- -
As-Welded with 95% Ar/5% O ₂	650 (94)	730 (106)	25	125 (92)	- -
As-Welded with 75% Ar/25% CO ₂	620 (90)	705 (102)	26	124 (91)	122 (90)

WIRE COMPOSITION – As Required per AWS A5.28

	%C	%Mn	%Si	%Ni
Requirements - AWS ER80S-D2, ER90S-D2	0.07-0.12	1.60-2.10	0.50-0.80	0.15 max
Typical Results⁽³⁾	0.09-0.11	1.63-1.74	0.56-0.64	≤ 0.04
	%Mo	%S	%P	%Cu (Total) ⁽⁴⁾
Requirements - AWS ER80S-D2, ER90S-D2	0.40-0.60	0.025 max	0.025 max	0.50 max
Typical Results⁽³⁾	0.43-0.46	≤ 0.010	0.007-0.016	0.16-0.22

TYPICAL OPERATING PROCEDURES

Diameter, Polarity Shielding Gas	CTWD ⁽⁵⁾ mm (in)	Wire Feed Speed m/min (in/min)	Voltage (volts)	Approx. Current (amps)	Melt-Off Rate kg/hr (lb/hr)
0.035 in (0.9 mm), DC+					
Short Circuit Transfer 75% Ar/25% CO ₂ ⁽⁶⁾	9-12 (3/8-1/2)	2.5 (100)	18	80	0.7 (1.6)
		3.8 (150)	19	120	1.1 (2.4)
		6.4 (250)	22	175	1.8 (4.0)
Spray Transfer 90% Ar/10% CO ₂	12-19 (1/2-3/4)	9.5 (375)	23	195	2.7 (6.0)
		12.7 (500)	29	230	3.6 (8.0)
		15.2 (600)	30	275	4.4 (9.6)
0.045 in (1.1 mm), DC+					
Short Circuit Transfer 75% Ar/25% CO ₂ ⁽⁶⁾	12-19 (1/2-3/4)	3.2 (125)	19	145	1.5 (3.4)
		3.8 (150)	20	165	1.8 (4.0)
		5.1 (200)	21	200	2.5 (5.4)
Spray Transfer 90% Ar/10% CO ₂	12-19 (1/2-3/4)	8.9 (350)	27	285	4.2 (9.2)
		12.1 (475)	30	335	5.7 (12.5)
		12.7 (500)	30	340	6.0 (13.2)
0.052 in (1.3 mm), DC+					
Spray Transfer 90% Ar/10% CO ₂	12-19 (1/2-3/4)	7.6 (300)	30	300	4.8 (10.6)
		8.1 (320)	30	320	5.2 (11.5)
		12.3 (485)	32	430	7.8 (17.1)
1/16 in (1.6 mm), DC+					
Spray Transfer 90% Ar/10% CO ₂	12-25 (1/2-1)	5.3 (210)	25	325	4.8 (10.7)
		6.0 (235)	27	350	5.4 (12.0)
		7.4 (290)	28	430	6.7 (14.8)

⁽¹⁾Typical all weld metal. ⁽²⁾Measured with 0.2% offset. ⁽³⁾See test results disclaimer. ⁽⁴⁾Copper due to any coating on the electrode plus the copper content of the filler metal itself shall not exceed the stated 0.50% max. ⁽⁵⁾CTWD (Contact Tip to Work Distance). Subtract 1/4 in (6.4 mm) to calculate Electrical Stickout. ⁽⁶⁾Procedures in these areas are procedures for short circuiting mode using 75% Argon, 25% CO₂. NOTE: For 100% CO₂ procedures, add 1 to 2 volts for short circuit transfer and 2 to 3 volts for globular transfer.

SUPERARC® LA-100™

Low Alloy, Copper Coated · AWS ER100S-G, ER110S-G & EM2

KEY FEATURES

- Capable of producing welds with 690 MPa (100 ksi) tensile strength
- Excellent for welding quenched and tempered steels and HY-80 base materials
- Supports short-circuiting, globular, axial spray and pulsed spray transfer
- Copper coating provides superior arc-starting characteristics for long contact tip life

WELDING POSITIONS

All

SHIELDING GAS

75-95% Argon / Balance CO₂
95-98% Argon / Balance O₂
Flow Rate: 30 - 50 CFH

CONFORMANCES

AWS A5.28: ER100S-G, ER110S-G
ABS - Part 2: 4YQ550SA
CWB AWS A5.28: ER69S-G (ER100S-G)
ISO 16834-A: T 69 5 M21 Mn3Ni,5Mo
ISO 26304-A: SZ

TYPICAL APPLICATIONS

- HY-80 base material
- ASTM A514, A543, A724 and A782 quenched and tempered plate
- Various heat input conditions
- Military low alloy applications

DIAMETERS / PACKAGING

Diameter in (mm)	33 lb (15 kg) Steel Spool	44 lb (20 kg) Steel Spool	60 lb (27.2 kg) Coil	500 lb (227 kg) Accu-Trak® Drum	500 lb (227 kg) Accu-Pak® Box
0.035 (0.9)		EDS30778		ED031445	
0.045 (1.1)	ED031417	EDS30779		EDS01162	ED036608
1/16 (1.6)			ED010996		

MECHANICAL PROPERTIES⁽¹⁾ – As Required per AWS A5.28

	Yield Strength ⁽²⁾ MPa (ksi)	Tensile Strength MPa (ksi)	Elongation %	Charpy V-Notch J (ft-lbf)	
				@ -18°C (0°F)	@ -51°C (-60°F)
Requirements - AWS ER100S-G As-Welded - Gas Not Specified	Not Specified	690 (100) min	Not Specified	Not Specified	Not Specified
AWS ER110S-G As-Welded - Gas Not Specified	Not Specified	760 (110) min	Not Specified	Not Specified	Not Specified
MIL-100S-1 per MIL-E-23765/2C, 2D, 2E & T9074-BC-G1B-010/0200 As-Welded with 98% Ar / 2% O ₂	565-825 (82-120)	Not Specified	16 min.	81 (60) min	47 (35) min
Typical Results⁽³⁾					
As-Welded at 30 kJ/in with 95% Ar/5% CO ₂	750 (109)	790 (115)	22	164 (121)	138 (102)
As-Welded at 45 kJ/in with 98% Ar/2% O ₂	730 (106)	780 (114)	20	- -	118 (87)
Pulse					
As-Welded at 110 kJ/in with 95% Ar/5% CO ₂	580 (84)	745 (108)	25	138 (102)	70 (52)
CV					
As-Welded at 110 kJ/in with 95% Ar/5% CO ₂	620 (90)	740 (107)	25	170 (125)	106 (78)
As-Welded at 45 kJ/in with 95% Ar/5% CO ₂	682 (99)	765 (111)	20	- -	117 (86)

⁽¹⁾Typical all weld metal. ⁽²⁾Measured with 0.2% offset. ⁽³⁾See test results disclaimer

WIRE COMPOSITION – As Required per AWS A5.28

	%C	%Mn	%Si	%Ni	%Mo
Requirements - AWS ER100S-G, ER110S-G	-	-	-	(A)	(A)
Typical Results ^(B)	0.05-0.06	1.63-1.69	0.46-0.50	1.88-1.96	0.43-0.45
	%Cr	%S	%P	%V	
Requirements - AWS ER100S-G, ER110S-G	(A)	-	-	-	
Typical Results ^(B)	0.04-0.06	0.002-0.005	0.005-0.009	≤ 0.01	
	%Al	%Ti	%Zr	%Cu	
Requirements - AWS ER100S-G, ER110S-G	-	-	-	-	
Typical Results ^(B)	≤ 0.01	0.03-0.04	≤ 0.01	0.11-0.14	

(A) Must have the minimum of one or more of the following: 0.50% Ni, 0.30% Cr, or 0.20% Mo.

TYPICAL OPERATING PROCEDURES

Diameter, Polarity Shielding Gas	CTWD ^(B) mm (in)	Wire Feed Speed m/min (in/min)	Voltage (volts)	Approx. Current (amps)	Melt-Off Rate kg/hr (lb/hr)
0.035 in (0.9 mm), DC+					
Short Circuit Transfer 75% Ar/25% CO ₂	9-12 (3/8-1/2)	2.5 (100)	18	80	0.7 (1.6)
		3.8 (150)	19	120	1.1 (2.4)
		6.4 (250)	22	175	1.8 (4.0)
Spray Transfer 90% Ar/10% CO ₂	9-12 (3/8-1/2)	9.5 (375)	23	195	2.7 (6.0)
		12.7 (500)	29	230	3.6 (8.0)
		15.2 (600)	30	275	4.4 (9.6)
0.045 in (1.1 mm), DC+					
Pulsed Spray Transfer ^(B)	12-19 (1/2-3/4)	5.1 (200)	19-21	130	2.4 (5.4)
		6.4 (250)	20-23	140	3.0 (6.7)
Spray Transfer 98% Ar/2% O ₂ 95% Ar/5% CO ₂	12-19 (1/2-3/4)	8.9 (350)	27	285	4.2 (9.2)
		12.1 (475)	30	335	5.7 (12.5)
		12.7 (500)	30	340	6.0 (13.2)
1/16 in (1.6 mm), DC+					
Spray Transfer 98% Ar/2% O ₂ 95% Ar/5% CO ₂	12-25 (1/2-1) 12-25 (1/2-1)	5.3 (210)	25	325	4.8 (10.7)
		6.0 (235)	27	350	5.4 (12.0)
		7.4 (290)	28	430	6.7 (14.8)

⁽¹⁾Typical all weld metal. ⁽²⁾Measured with 0.2% offset. ⁽³⁾See test results disclaimer ⁽⁴⁾CTWD (Contact Tip to Work Distance). Subtract 1/4 in (6.4 mm) to calculate Electrical Stickout.

⁽⁵⁾Procedures in this area are for pulse MIG mode for welding in the vertical up and overhead welding positions. Actual results are dependent on joint, material thickness, as well as wave shape and pulse frequency.

SUPERARC® AK-10®

Low Alloy, Copper Coated · AWS ER100S-G

KEY FEATURES

- Capable of producing welds with 690 MPa (100 ksi) tensile strength
- Suitable for use where consumables with less than 1% Ni are required
- Batch Managed Inventory
- MicroGuard® Ultra provides superior feeding and arc stability
- Q2 Lot® - Certificates showing actual wire chemistry available online
- Copper coating provides superior arc-starting characteristics for long contact tip life

WELDING POSITIONS

All

SHIELDING GAS

100% CO₂
 75-95% Argon / Balance CO₂
 95-98% Argon / Balance O₂
 Flow rate: 30-50CFH

CONFORMANCES

AWS A5.28: ER100S-G

ASME Section IX: A-No. 10

TYPICAL APPLICATIONS

- NACE applications
- Oil tools
- Riser systems
- High-strength pipe

TYPICAL BASE METALS

HY-80 or HY-100 per MIL-S-16216, A514 Grade B or P, AISI 4130 or 8620, API X-70 or X-80

DIAMETERS / PACKAGING

Diameters in (mm)	33 lb (15kg) Steel Spool	500 lb (227kg) Accu-Trak Drum
0.035 (0.9)	ED034894	ED034896
0.045 (1.1)	ED034895	ED034897

WIRE COMPOSITION – As Required per AWS A5.28

	%C	%Mn	%Si	%Ni	%Mo	%Cr
Requirements - AWS A5.28: ER100S-G	—	—	—	(A)	(A)	(A)
Typical Results	0.10	1.55	0.57	0.88	0.47	0.28
	%S	%P	%V	%Al	%Cu	
Requirements - AWS A5.28: ER100S-G	—	—	—	—	—	
Typical Results	< 0.005	0.01	< 0.003	0.003	0.12	

(A) Must have the minimum of one or more of the following: 0.50% Ni, 0.30% Cr, or 0.20% Mo. ⁽¹⁾Typical all weld metal.

MECHANICAL PROPERTIES⁽¹⁾ – As Required per AWS A5.28

	Yield Strength ⁽²⁾ MPa (ksi)	Tensile Strength MPa (ksi)	Elongation (%)	Charpy V-Notch J (ft-lbf)	
				-40°C (40°F)	-51°C (60°F)
Requirements AWS A5.28: ER100S-G As-Welded with 90% Ar/10% CO ₂	Not Specified	690 (100) min	Not Specified	Not Specified	Not Specified
Typical Results As-Welded with 90% Ar/10% CO ₂	709 (103)	802 (116)	21	86 (64)	85 (63)
Stress Relieved 1 hr. @ 621°C (1150°F) with 90% Ar/10% CO ₂	627 (91)	723 (105)	25	113 (83)	100 (73)

TYPICAL OPERATING PROCEDURES

Diameter, Polarity Shielding Gas	CTWD ⁽³⁾ mm (in)	Wire Feed Speed m/min (in/min)	Voltage (volts)	Approx. Current (amps)	Melt-Off Rate kg/hr (lb/hr)
0.035 in (0.9 mm), DC+					
Short Circuit Transfer 90% Ar/10% CO ₂	9-12 (3/8-1/2)	2.5 (100)	18	80	0.7 (1.6)
		3.8 (150)	19	120	1.1 (2.4)
		6.4 (250)	22	175	1.8 (4.0)
Spray Transfer 90% Ar/10% CO ₂	9-12 (3/8-1/2)	9.5 (375)	23	195	2.7 (6.0)
		12.7 (500)	29	230	3.6 (8.0)
		15.2 (600)	30	275	4.4 (9.6)
0.045 in (1.1 mm), DC+					
Pulsed Spray Transfer ⁽⁵⁾	12-19 (1/2-3/4)	5.1 (200)	19-21	130	2.4 (5.4)
		6.4 (250)	20-23	140	3.0 (6.7)
Spray Transfer 98% Ar/2% O ₂ 95% Ar/5% CO ₂	12-19 (1/2-3/4)	8.9 (350)	27	285	4.2 (9.2)
		12.1 (475)	30	335	5.7 (12.5)
		12.7 (500)	30	340	6.0 (13.2)
0.052 in (1.3 mm), DC+					
Spray Transfer 98% Ar/2% O ₂ 95% Ar/5% CO ₂	12-25 (1/2-1)	5.3 (210)	25	325	4.8 (10.7)
		6.0 (235)	27	350	5.4 (12.0)
		7.4 (290)	28	430	6.7 (14.8)

⁽¹⁾Typical all weld metal. ⁽²⁾Measured with 0.2% offset. ⁽³⁾See test results disclaimer ⁽⁴⁾CTWD (Contact Tip to Work Distance). Subtract 1/4 in (6.4 mm) to calculate Electrical Stickout.

⁽⁵⁾Procedures in this area are for pulse MIG mode for welding in the vertical up and overhead welding positions. Actual results are dependent on joint, material thickness, as well as wave shape and pulse frequency.

SUPERGLAZE™ SiBR

Copper Alloys · AWS ERCuSi-A / ISO Cu 6560

KEY FEATURES

- Silicon Bronze is designed for MIG brazing galvanized steel and other applications where a high quality finish is demanded
- High corrosion resistance
- Suitable for GMAW, laser and plasma brazing

WELDING POSITIONS

All positions

SHIELDING GAS

100% Argon
Flow Rate: 30 - 50 CFH

CONFORMANCES

AWS A5.7 ERCuSi-A
ISO 24373 S Cu 6560 (CuSi3Mn1)

TYPICAL APPLICATIONS

- Automotive components
- Galvanized steel
- Dissimilar metals
- Copper alloys with similar composition and brass
- Car body construction

DIAMETERS / PACKAGING

Diameter in (mm)	33 lb (15 kg) Plastic Spool	500 lb (227 kg) Gem-Pak® Box
0.035 (0.9)	ED036805	ED036802
0.040 (1.0)	ED036806	ED036803
0.045 (1.1)	ED036807	ED036804

MECHANICAL PROPERTIES⁽¹⁾

	Yield Strength ⁽²⁾ MPa (ksi)	Tensile Strength MPa (ksi)	Elongation %	Hardness HB
Requirements - AWS ERCuSi-A	-	-	-	-
Typical Results ⁽³⁾ - As-Welded	182.7 (26.50)	374.0 (54.25)	58.8	89.6

WIRE COMPOSITION – As Required per ISO 24373

	%Al	%Mn	%Si	%Sn	%P
Requirements - S Cu 6560	0.02	0.5-1.5	2.8-4.0	0.2	0.05
Typical Results ⁽³⁾	0.002	0.65	2.97	0.005	0.0007
	%Pb	%Fe	%Zn	Other	
Requirements - S Cu 6560	0.02	0.5	0.4	0.5	
Typical Results ⁽³⁾	0.003	0.01	0.02	-	

TYPICAL OPERATING PROCEDURES⁽⁴⁾

Diameter in (mm)	Wire Feed Speed in/min (m/min)	Voltage (volts)	Current (Amps)	Argon Gas Flow (CFH)
0.035 (0.9)	400-440 (10-11)	23-25	145-185	30 - 50 CFH
0.040 (1.0)	340-375 (8-9)	24-26	170-200	
0.045 (1.1)	280-310 (7-8)	26-28	195-215	

⁽¹⁾ Typical all weld metal ⁽²⁾ Measured with 0.2% offset ⁽³⁾ See test results disclaimer ⁽⁴⁾ Suggested parameters are basic guidelines that will vary according to joint design, number of passes and other aspects.

5CRMO

Low Alloy Steel · AWS ER80S-B6

KEY FEATURES

- Developed for 5%Cr-0.50%Mo creep resisting steels
- Designed for high strength and improved corrosion resistance with hot hydrogen gas, super-heated steam, and Sulphur crude oil

WELDING POSITIONS

All

SHIELDING GAS

100% Argon

CONFORMANCES

AWS 5.28: ER80S-B6
BS EN ISO 21952-A CrMo5Si

TYPICAL APPLICATIONS

- Pressure Vessels
- Piping
- Heat Exchangers

DIAMETERS / PACKAGING

Diameter mm (in)	5 kg (11 lb) Tube
2.4 (3/32)	T5CRMO-24
3.2 (1/8)	T5CRMO-32

MECHANICAL PROPERTIES⁽¹⁾ – As Required per AWS A5.28

	Yield Strength ⁽²⁾ MPa (ksi)	Tensile Strength MPa (ksi)	Elongation %	Charpy V-Notch J (ft-lbf) @20°C (68°F)	Hardness HV
Requirements AWS ER80S-B6	470 (68) min	590 (86) min	17 min	-	-
Typical Results⁽³⁾ As-Welded	530 (77)	640 (93)	28	240	195

WIRE COMPOSITION⁽¹⁾ – As Required per AWS A5.28

	%C	%Mn	%Si	%S	%P
Requirements AWS ER80S-B6	0.03-0.10	0.40-0.70	0.30-0.50	0.02 max	0.02 max
Typical Results⁽³⁾	0.07	0.5	0.4	0.01	0.01
	%Cr	%Ni	%Mo	%Cu	%V
Requirements AWS ER80S-B6	5.5-6.0	0.3 max	0.50-0.65	0.3 max	0.03 max
Typical Results⁽³⁾	5.7	0.1	0.55	0.2	0.02

⁽¹⁾ Typical all weld metal ⁽²⁾ Measured with 0.2% offset ⁽³⁾ See test results disclaimer

LINCOLN® ER80S-D2

Low Alloy Steel · AWS ER80S-D2

KEY FEATURES

- Capable of producing weld deposits with 550 MPA (80 KSI) tensile strength
- Contains 0.50% molybdenum for strength after stress valves
- Q2 Lot® - Certificates showing actual wire chemistry available online
- Ink jet printing identification on entire length of electrode

WELDING POSITIONS

All

CONFORMANCES

AWS A5: ER80S-D2, ER90S-D2

TYPICAL APPLICATIONS

- Requirements for strengths after stress relieving
- ASTM A182, A217, A234 and A335 - High temperature service pipe, fittings, flanges and valves
- ASTM A336 pressure vessel forgings

SHIELDING GAS

100% Argon

DIAMETERS / PACKAGING

Diameter in (mm)	10 lb (4.5 kg) Plastic Tube 30 lb (13.6 kg) Master Carton
1/16 (1.6)	ED034219
3/32 (2.4)	ED034220
1/8 (3.2)	ED034221

WIRE COMPOSITION⁽¹⁾ – As Required per AWS A5.28

	%C	%Mn	%Si	%S
Requirements - AWS ER80S-D2	0.07-0.12	1.60-2.10	0.50-0.80	0.025 max
	%P	%Cu ⁽⁴⁾	%Ni	%Mo
Requirements - AWS ER80S-D2	0.025 max	0.50 max	0.15 max	0.40 max

⁽⁴⁾Copper due to any coating on the electrode plus the copper content of the filler metal itself, shall not exceed the stated 0.50% max.

LINCOLN® ER80S-Ni1

Low Alloy Steel · AWS ER80S-Ni1

KEY FEATURES

- Capable of producing weld deposits with 550 MPA (80 KSI) tensile strength
- High toughness at low temperatures with a nominal 1% Ni or less
- Q2 Lot® - Certificates showing actual wire chemistry available online
- Ink jet printing identification on entire length of electrode

WELDING POSITIONS

All

CONFORMANCES

AWS A5: ER80S-Ni1

TYPICAL APPLICATIONS

- ASTM A588 weathering steel requiring good atmospheric corrosion resistance
- NACE applications

SHIELDING GAS

100% Argon

DIAMETERS / PACKAGING

Diameter in (mm)	10 lb (4.5 kg) Plastic Tube 30 lb (13.6 kg) Master Carton
1/16 (1.6)	ED034346
3/32 (2.4)	ED034347
1/8 (3.2)	ED034348

WIRE COMPOSITION⁽¹⁾ – As Required per AWS A5.28

	%C	%Mn	%Si	%Ni	%Cr
Requirements - AWS ER80S-Ni1	0.12 max	1.25 max	0.40-0.80	0.80-1.10	0.15 max
Typical Results⁽³⁾	0.07-0.08	0.94-1.04	0.54-0.58	0.88-0.98	≤ 0.04
	%Mo	%S	%P	%V	%Cu [Total] ⁽⁴⁾
Requirements - AWS ER80S-Ni1	0.035 max	0.025 max	0.025 max	0.05 max	0.35 max
Typical Results⁽³⁾	≤ 0.02	0.007-0.10	0.005-0.010	< 0.01	0.16-0.21

⁽³⁾See test results disclaimer ⁽⁴⁾Copper due to any coating on the electrode plus the copper content of the filler metal itself, shall not exceed the stated 0.50% max.

LINCOLN® LA-84

Low Alloy Steel · AWS ER90S-G

KEY FEATURES

- A nickel-bearing electrode with 0.5% molybdenum
- Available as Batch Managed Inventory
- Can be used for higher strength weldments where impact properties exceeding 27 J (20 ft·lbf) at -62°C (-80°F) are required
- Suitable for use where consumables with less than 1% Ni are required
- Ink jet printing identification on entire length of electrode

WELDING POSITIONS

All

CONFORMANCES

AWS A5.28: ER90S-G

TYPICAL APPLICATIONS

- Low temperature toughness requirements
- NACE

SHIELDING GAS

100% Argon

DIAMETERS / PACKAGING

Diameter in (mm)	10 lb (4.5 kg) Plastic Tube 30 lb (13.6 kg) Master Carton
1/16 (1.6)	ED034349
3/32 (2.4)	ED034350
1/8 (3.2)	ED034351

WIRE COMPOSITION⁽¹⁾ – As Required per AWS A5.28

	%C	%Mn	%Si	%S	%P	%Ni	%Mo	%Cu
Requirements - AWS ER90S-G	0.10-0.18	1.75-2.20	0.2	0.010-0.020	0.010-0.020	0.80-1.0	0.45-0.60	0.05-0.15

⁽¹⁾Typical all weld metal.

TECHALLOY® 4130

Low Alloy Steel

KEY FEATURES

- High strength, low alloy
- Preheat and inter-pass temperature of 400°F (204.4°C) is required

WELDING POSITIONS

All

TYPICAL APPLICATIONS

- Joining steels of similar chemical composition
- Overlays where moderate hardness is required

SHIELDING GAS

100% Argon

DIAMETERS / PACKAGING

Diameter in (mm)	TIG 50 lb (22.7 kg) Master Carton
1/16 (1.6)	TG4130062628
3/32 (2.4)	TG4130093628
1/8 (3.2)	TG4130125628

MECHANICAL PROPERTIES^[4]

	Yield Strength ^[2] MPa (ksi)	Tensile Strength MPa (ksi)	Elongation %
Typical Results ^[3]	900 (130)	1,000 (145)	11

WIRE COMPOSITION^[1]

	%C	%Mn	%Si	%Fe	%Cr	%Mo	%Ni	%V
Typical Results ^[3]	0.31	0.52	0.28	Balance	0.93	0.20	-	-

^[1]Typical deposit composition. ^[2]Measured with 0.2% offset. ^[3]See test results disclaimer. ^[4]Quenched from 1,550 F (843 C) in oil and tempered at 1,050 ° F (565 ° C). Safety Data Sheets (SDS) are available on our website at www.lincolnelectric.com

LINCOLN® AK-10®

Low Alloy Steel · AWS ER100S-G

KEY FEATURES

- Capable of producing welds with 690 MPa (100 ksi) tensile strength
- Suitable for use where consumables with less than 1% Ni are required
- Batch Managed Inventory
- Q2 Lot® - Certificates showing actual wire chemistry available online
- Ink jet printing identification on entire length of electrode

WELDING POSITIONS

All

CONFORMANCES

AWS A5.28: ER100S-G

TYPICAL APPLICATIONS

- NACE applications
- Oil tools
- Riser systems
- High-strength pipe

TYPICAL BASE METALS

HY-80 or HY-100 per MIL-S-16216, A514 Grade B or P, AISI 4130 or 8620, API X-70 or X-80

SHIELDING GAS

100% Argon

DIAMETERS / PACKAGING

Diameters in (mm)	10 lb. (4.5 kg) Plastic Tube 30 lb (13.6 kg) Master Carton
1/16 (1.6)	ED034898
3/32 (2.4)	ED034899
1/8 (3.2)	ED034900

WIRE COMPOSITION⁽¹⁾ - As Required per AWS A5.28

	%C	%Mn	%Si	%Ni	%Mo	%Cr
Requirements - AWS ER100S-G	—	—	—	(A)	(A)	(A)
Typical Results⁽²⁾	0.10	1.55	0.57	0.88	0.48	0.27
	%S	%P	%V	%Al	%Cu	
Requirements - AWS ER100S-G	—	—	—	—	—	
Typical Results⁽²⁾	< 0.005	0.01	< 0.003	0.004	0.09	

(A) Must have the minimum of one or more of the following: 0.50% Ni, 0.30% Cr, or 0.20% Mo. (2) See test results disclaimer

LINCOLN® ER70S-2

Mild Steel, Copper Coated · AWS ER70S-2

KEY FEATURES

- Contains zirconium, titanium, and aluminum in addition to silicon and manganese
- Produces x-ray quality welds over most surface conditions
- Recommended for TIG welding on all grades of steel
- Ink jet printing identification on entire length of electrode
- Q2 Lot® - Certificates showing actual wire chemistry available online

WELDING POSITIONS

All

CONFORMANCES

AWS A5:	ER70S-2
CWB/CSA:	ER70S-2
ISO:	W 49 2

TYPICAL APPLICATIONS

- Repairs on a variety of mild and low alloy steel
- Small diameter pipe and tubing
- Sheet metal applications
- Root pass pipe welding

SHIELDING GAS

100% Argon

DIAMETERS / PACKAGING

Diameter in (mm)	10 lb (4.5 kg) Carton	5 lb (2.3 kg) Plastic Tube 20 lb (9.1 kg) Master Carton	10 lb (4.5 kg) Plastic Tube 30 lb (13.6 kg) Master Carton	50 lb (22.7 kg) Carton
1/16 (1.6)	ED033952*	ED034325	ED034328	ED034331
3/32 (2.4)	ED033953*	ED034326	ED034329	ED034332
1/8 (3.2)	ED033954*	ED034327	ED034330	ED034333
5/32 (4.0)			ED034810	

* Nuclear Tested Product

WIRE COMPOSITION⁽¹⁾ – As Required per AWS A5.18

	%C	%Mn	%S	%Si	%P	%Cu	%Cr
Requirements - AWS ER70S-2	0.07 max	0.90-1.40	0.035 max	0.40-0.70	0.0025 max	0.50 max	(1)
Typical Results⁽²⁾	0.04	1.08	0.005	0.55	0.0003	0.20	0.08
	%Ni	%Mo	%V	%Al	%Ti	%Zr	
Requirements - AWS ER70S-2	(1)	(1)	(1)	0.05-0.15	0.05-0.15	0.02-0.12	
Typical Results⁽²⁾	0.08	0.08	< 0.002	0.08	0.10	0.07	

⁽¹⁾Total 0.50% maximum, combined. ⁽²⁾See test results disclaimer

LINCOLN® ER70S-6

Mild Steel, Copper Coated · AWS ER70S-6

KEY FEATURES

- High levels of manganese and silicon deoxidizers tolerate medium to heavy mill scale surfaces
- More puddle fluidity than ER70S-2
- Excellent wetting action
- Ink jet printing identification on entire length of electrode
- Q2 Lot® - Certificates showing actual wire chemistry available online

WELDING POSITIONS

All

CONFORMANCES

AWS A5:	ER70S-6
CWB/CSA:	B-G 49A 3 C1 S6
ISO:	W 49 6

TYPICAL APPLICATIONS

- Repairs on a variety of mild and low alloy steel
- Small diameter pipe and tubing
- Sheet metal applications
- Root pass pipe welding

SHIELDING GAS

100% Argon

DIAMETERS / PACKAGING

Diameter in (mm)	5 lb (2.3 kg) Plastic Tube 20 lb (9.1 kg) Master Carton	10 lb (4.5 kg) Plastic Tube 30 lb (13.6 kg) Master Carton	50 lb (22.7 kg) Carton
1/16 (1.6)	ED034334	ED034337	ED034340
3/32 (2.4)	ED034335	ED034338	ED034341
1/8 (3.2)	ED034336	ED034339	ED034342
5/32 (4.0)		ED034781	

WIRE COMPOSITION⁽¹⁾ – As Required per AWS A5.18

	%C	%Mn	%S	%Si	%P
Requirements - AWS ER70S-6	0.06-0.15	1.40-1.85	0.035 max	0.80-1.15	0.025 max
Typical Results⁽²⁾	0.09	<1.60	0.007	0.90	0.007
	%Cu	%Cr	%Ni	%Mo	%V
Requirements - AWS ER70S-6	0.50 max	(1)	(1)	(1)	(1)
Typical Results⁽²⁾	0.20	0.05	0.05	0.05	0.05

⁽¹⁾Total 0.50% maximum, combined. ⁽²⁾See test results disclaimer

CONSUMABLES

METAL-CORED



METALSHIELD® MC-70 XLS™

Mild Steel · AWS E70C-6M-H4

KEY FEATURES

- Minimal silicon islands for an exceptionally clean weld surface
- Minimal post weld clean up
- Best-in-class edge wetting for excellent bead appearance
- Smooth, stable arc characteristics with low spatter levels
- Tolerates welding over mill scale and rust
- Low H4 diffusible hydrogen levels
- High deposition rates and fast travel speeds

WELDING POSITIONS

Flat & Horizontal (CV processes)
Out of Position (Pulse waveforms)

CONFORMANCES

AWS A5.18:	E70C-6M-H4
CWB/CSA:	E491T15-M21A4-CS1-H4, E491T15-M20A4-CS1-H4 [E491C-6MJ-H4]
CSA W48:	E491T15-GA4-CS1-H4 [E491C-6MJ-H4]
AWS D1.8:	E70 HHI -20, E70 LHI -20

TYPICAL APPLICATIONS

- Robotics/Hard Automation
- Structural Fabrication
- Heavy Fabrication
- Pressure Vessels
- Agriculture

SHIELDING GAS

75-92% Argon / Balance CO₂
Flow rate: 40-60 CFH

DIAMETERS/PACKAGING

Diameter in (mm)	33 lb (15 kg) Steel Spool	50 lb (22.7 kg) Fiber Spool	750 lb (340 kg) Accu-Trak® Drum
0.045 (1.1)	ED037105	ED037416	ED037281
0.052 (1.3)	ED037106	ED037417	ED037282
1/16 (1.6)	ED037107	ED037418	ED037283

MECHANICAL PROPERTIES⁽¹⁾

	Yield Strength ⁽²⁾ MPa (ksi)	Tensile Strength MPa (ksi)	Elongation %	Charpy V-Notch J (ft-lbf) @ -40°C (-40°F)
Requirements AWS A5.18: E70C-6M-H4	400 (58) min	480 (70) min	22 min	27 (20) min
AWS A5.36: E70T15-M20A4-CS1-H4, E70T15-M21A4-CS1-H4		490-660 (70-95)		
Typical Results ⁽³⁾ As-Welded with 75% Argon / 25% CO ₂	450-510 (65-75)	510-590 (75-85)	26-30	40-75 (30-55)
As-Welded with 90% Argon / 10% CO ₂	450-550 (65-80)	550-620 (80-90)	26-30	60-105 (45-75)

⁽¹⁾Typical all weld metal. ⁽²⁾Measured with 0.2% offset. ⁽³⁾See test results disclaimer.

DEPOSIT COMPOSITION⁽¹⁾

	%C	%Mn	%Si	%S	%P	%Cu
Requirements AWS A5.18: E70C-6M-H4	0.12 max.	1.75 max.	0.90 max.	0.03 max.	0.03 max.	0.50 max.
AWS A5.36: E70T15-M20A4-S1-H4, E70T15-M21A4-CS1-H4				0.030 max.	0.030 max.	
Typical Performance ⁽²⁾ As-Welded with 75% Ar / 25% CO ₂ As-Welded with 90% Ar / 10% CO ₂	0.04-0.07	1.25-1.55 1.25-1.60	0.55-0.80 0.60-0.85	0.010-0.020	0.005-0.010	0.01-0.05
	%Ni	%Cr	%Mo	%V	Diffusible Hydrogen (mL/100g weld deposit)	
Requirements AWS A5.18: E70C-6M-H4	0.50 max.	0.20 max.	0.30 max.	0.08 max.	4.0 max.	
AWS A5.36: E70T15-M20A4-S1-H4, E70T15-M21A4-CS1-H4					4 max.	
Typical Performance ⁽²⁾ As-Welded with 75% Ar / 25% CO ₂ As-Welded with 90% Ar / 10% CO ₂	0.30-0.40	0.01-0.03	0.01-0.02	0.01-0.02	2-4	

TYPICAL OPERATING PROCEDURES

Diameter, Polarity Shielding Gas	CTWD ⁽⁴⁾ mm (in)	Wire Feed Speed m/min (in/min)	Voltage ⁽⁵⁾ (volts)	Approx. Current (amps)	Melt-Off Rate kg/hr (lb/hr)	Deposition Rate kg/hr (lb/hr)	Efficiency (%)
0.045 in (1.1 mm), DC+ 90% Argon / 10% CO ₂	19-25 (3/4-1)	5.1 (200)	21-23	155	2.3 (5.0)	2.1 (4.6)	92
		6.4 (250)	22-24	185	2.8 (6.2)	2.6 (5.8)	94
		7.6 (300)	22-26	220	3.5 (7.7)	3.2 (7.0)	91
		8.9 (350)	22-27	245	4.0 (8.9)	3.7 (8.2)	93
		10.2 (400)	23-27	260	4.6 (10.1)	4.3 (9.4)	93
		11.4 (450)	23-28	280	5.2 (11.4)	4.9 (10.7)	94
		12.7 (500)	23-29	305	5.7 (12.6)	5.5 (12.2)	97
		14.0 (550)	24-29	315	6.3 (13.9)	6.2 (13.6)	98
		15.2 (600)	25-30	325	6.8 (15.1)	6.7 (14.8)	98
		16.5 (650)	26-30	355	7.5 (16.5)	7.4 (16.3)	98
17.8 (700)	26-30	360	8.0 (17.7)	8.0 (17.7)	7.9 (17.5)	99	
0.052 in (1.3 mm), DC+ 90% Argon / 10% CO ₂	19-25 (3/4-1)	5.1 (200)	22-24	210	3.1 (6.8)	2.9 (6.3)	94
		6.4 (250)	22-26	260	3.9 (8.5)	3.5 (7.8)	92
		7.6 (300)	22-27	290	4.6 (10.2)	4.3 (9.5)	94
		8.9 (350)	23-28	315	5.4 (11.9)	5.2 (11.4)	97
		10.2 (400)	24-28	350	6.2 (13.6)	6.1 (13.4)	97
		11.4 (450)	25-28	370	6.9 (15.3)	6.8 (15.1)	99
		12.7 (500)	27-29	390	7.7 (17.0)	7.6 (16.8)	99
		14.0 (550)	27-30	420	8.4 (18.6)	8.3 (18.3)	99
1/16 in (1.6 mm), DC+ 90% Argon / 10% CO ₂	25-32 (1-1 1/4)	3.8 (150)	22-24	230	3.2 (7.0)	2.8 (6.2)	89
		5.1 (200)	22-25	280	4.3 (9.4)	3.9 (8.7)	93
		6.4 (250)	23-27	310	5.3 (11.6)	5.0 (11.0)	94
		7.6 (300)	24-28	370	6.3 (13.9)	6.3 (13.8)	99
		8.9 (350)	26-30	400	7.4 (16.3)	7.2 (15.9)	98
		10.2 (400)	26-30	450	8.3 (18.4)	8.3 (18.4)	99
11.4 (450)	27-31	480	9.5 (21.0)	9.3 (20.6)	98		

⁽⁴⁾To estimate ESO, subtract 3/16 in (4.8 mm) from CTWD. ⁽⁵⁾For greater percentage of CO₂ shielding gas, increase voltage by 1-2 volts.

METALSHIELD® MC-6®

Mild Steel · AWS E70C-6M H4

KEY FEATURES

- Excellent performance in fast follow, high travel speed applications
- Optimal wetting action, even at low voltages
- H4 diffusible hydrogen level
- Use with Rapid-Arc® Waveform Control Technology® for increased travel speeds
- Deoxidizing arc action minimizes pre-weld work

WELDING POSITIONS

All

SHIELDING GAS

75-95% Argon / Balance CO₂
Flow Rate: 40-60 CFH

CONFORMANCES

- AWS A5.18:** E70C-6M-H4
- CWB:** E491T15-M21A4-CS1-H4 [E491C-6MJ-H4]
E491T15-M12A4-CS1-H4 [E491C-6MJ-H4]
- CSA W48:** E491T15-GA4-CS1-H4 [E491C-6MJ-H4],
E491T15-M22A4-CS1-H4 [E491C-6MJ-H4]
- ISO:** T49 4 T15-1 M A H5

TYPICAL APPLICATIONS

- Robotics/Hard automation
- Automotive
- Structural fabrication
- Process piping and pressure vessels
- General fabrication

DIAMETERS / PACKAGING

Diameter in (mm)	33 lb (15 kg) Steel Spool	50 lb (22.7 kg) Fiber Spool	60 lb (27.2 kg) Coil	500 lb (227 kg) Accu-Trak® Drum
0.045 [1.1]	ED030392	ED030554	ED030549	ED031011
0.052 [1.3]	ED030393	ED030556	ED030550	ED030946
1/16 [1.6]	ED030394	ED030555	ED030577	ED030947

MECHANICAL PROPERTIES⁽¹⁾ – As Required per AWS A5.18/A5.36

	Yield Strength ⁽²⁾ MPa (ksi)	Tensile Strength MPa (ksi)	Elongation %	Charpy V-Notch J [ft-lbf]	
				@ -29°C [-20°F]	@ -40°C [-40°F]
Requirements - AWS A5.18: E70C-6M-H4	400 [58] min	480 [70] min 490-660 [70-95]	22 min	27 [20] min	Not Specified
Typical Results ⁽³⁾					
As-Welded with 75% Argon / 25% CO ₂ ⁽⁴⁾	450-510 [65-75]	510-590 [75-85]	24-28	81-122 [60-90]	47-75 [35-55]
As-Welded with 90% Argon / 10% CO ₂	480-550 [70-80]	550-620 [80-90]	24-28	75-102 [55-75]	61-81 [45-60]

⁽¹⁾Typical all weld metal. ⁽²⁾Measured with 0.2% offset. ⁽³⁾See test results disclaimer ⁽⁴⁾Required gas mixture 75-80% Argon/Balance CO₂ for AWS testing.

DEPOSIT COMPOSITION⁽¹⁾ – As Required per AWS A5.18/A5.36

	%C	%Mn	%Si	%S	%P	%Cu	%Ni
Requirements - AWS A5.18: E70C-6M-H4	0.12 max	1.75 max	0.90 max	0.03 max 0.030 max	0.03 max 0.030 max	0.50 max 0.035 max	0.50 max
Typical Results ⁽²⁾							
As-Welded with 75% Argon / 25% CO ₂ ⁽⁴⁾	0.03-0.05	1.25-1.60	0.40-0.60	0.01-0.02	0.01-0.02	0.01-0.05	0.02-0.05
As-Welded with 90% Argon / 10% CO ₂	0.03-0.05	1.25-1.70	0.40-0.70	0.01-0.02	0.01-0.02	0.01-0.05	0.02-0.05
	%Cr	%Mo	%V	%B	%Ni + %Cr + %Mo + %V	Diffusible Hydrogen (mL/100g weld deposit)	
Requirements - AWS A5.18: E70C-6M-H4 AWS A5.36: E70T15-M20A4-CS1-H4	0.20 max	0.30 max	0.08 max	Not Specified	0.50 max	4.0 max 4 max	
Typical Results ⁽³⁾							
As-Welded with 75% Argon / 25% CO ₂ ⁽⁴⁾	0.01-0.04	0.01-0.02	0.01-0.02	0.004-0.005	0.05-0.10	2-4	
As-Welded with 90% Argon / 10% CO ₂	0.01-0.04	0.01-0.02	0.01-0.02	0.004-0.005	0.05-0.10		

TYPICAL OPERATING PROCEDURES

Diameter, Polarity Shielding Gas	CTWD ⁽⁵⁾ mm [in]	Wire Feed Speed m/min [in/min]	Voltage ⁽⁶⁾ (volts)	Approx. Current (amps)	Melt-Off Rate kg/hr [lb/hr]	Deposition Rate kg/hr [lb/hr]	Efficiency (%)
0.045 in [1.1 mm], DC+ 90% Argon / 10% CO ₂	19-25 (3/4-1)	5.1 [200]	21-23	170	2.5 [5.6]	2.3 [5.2]	92
		6.4 [250]	22-25	190	2.9 [6.4]	2.7 [6.1]	95
		7.6 [300]	22-26	210	3.5 [7.8]	3.2 [7.1]	92
		8.9 [350]	22-27	245	4.1 [9.1]	3.9 [8.7]	95
		10.2 [400]	23-27	265	4.6 [10.2]	4.5 [9.9]	97
		12.7 [500]	23-28	300	5.7 [12.6]	5.6 [12.4]	98
		15.2 [600]	25-29	335	7.0 [15.4]	6.9 [15.3]	99
		17.8 [700]	26-30	370	8.1 [17.8]	7.9 [17.5]	98
0.052 in [1.3 mm], DC+ 90% Argon / 10% CO ₂	19-25 (3/4-1)	5.1 [200]	22-24	220	3.2 [7.0]	2.9 [6.4]	92
		6.4 [250]	22-26	260	4.0 [8.7]	3.8 [8.3]	95
		7.6 [300]	22-27	300	4.9 [10.7]	4.7 [10.3]	96
		8.9 [350]	23-27	335	5.6 [12.3]	5.5 [12.0]	98
		10.2 [400]	24-28	360	6.3 [13.9]	6.3 [13.8]	99
		12.7 [500]	27-30	410	7.9 [17.4]	7.8 [17.3]	99
		15.2 [600]	27-31	455	9.5 [21.1]	9.4 [20.8]	99
1/16 in [1.6 mm], DC+ 90% Argon / 10% CO ₂	25-32 (1-1 1/4)	2.5 [100]	21-24	175	2.1 [4.7]	2.0 [4.4]	93
		3.8 [150]	22-25	235	3.2 [7.1]	2.9 [6.4]	90
		5.1 [200]	22-26	290	4.3 [9.5]	4.0 [8.9]	94
		6.4 [250]	22-28	345	5.4 [11.9]	5.2 [11.4]	96
		7.6 [300]	23-29	360	6.4 [14.2]	6.3 [13.9]	98
		10.2 [400]	26-31	425	8.5 [18.7]	8.4 [18.5]	99
		12.7 [500]	27-32	485	10.8 [23.8]	10.7 [23.5]	99

⁽¹⁾Typical all weld metal. ⁽²⁾Measured with 0.2% offset. ⁽³⁾See test results disclaimer ⁽⁴⁾Required gas mixture 75-80% Argon/Balance CO₂ for AWS testing. ⁽⁵⁾To estimate ESO, subtract 3/16 in [4.8 mm] from CTWD. ⁽⁶⁾For greater percentage of CO₂ shielding gas, increase voltage by 1-2 volts.

METALSHIELD® MC-710XL®

Mild Steel · AWS E70C-6M H8

KEY FEATURES

- High column strength for excellent feedability
- Tolerates moderate amounts of surface contaminants

WELDING POSITIONS

All

SHIELDING GAS

75-95% Argon / Balance CO₂
Flow Rate: 40-60 CFH

CONFORMANCES

AWS A5: E70C-6M-H8, E70C-G-H8,
E70T15-M20A2-CS1-H8,
E70T15-M21A2-CS1-H8

CWB/CSA: E491C-6M-H8, E491T15-M20A3-CS1-H8, E491T15-M21A3-CS1-H8

TYPICAL APPLICATIONS

- Automotive
- Structural fabrication
- General fabrication
- Applications where long conduit lengths or critical feeding is necessary

DIAMETERS / PACKAGING

Diameter in (mm)	33 lb (15 kg) Steel Spool	60 lb (27.2 kg) Coil	600 lb (272 kg) Accu-Trak® Drum
0.045 [1.1]	ED030592	ED028526	ED028450
0.052 [1.3]		ED028527	
1/16 [1.6]		ED028528	

MECHANICAL PROPERTIES⁽¹⁾ – As Required per AWS A5.18/A5.36

	Yield Strength ⁽²⁾ MPa (ksi)	Tensile Strength MPa (ksi)	Elongation %	Charpy V-Notch J (ft-lbf) @ -29°C (-20°F)
Requirements - AWS A5.18: E70C-6M-H8 AWS A5.36: E70T15-M20A2-CS1-H8	400 [58] min	480 [70] min 490-660 [70-95]	22 min	27 [20] min
Typical Results ⁽³⁾				
As-Welded with 75% Argon / 25% CO ₂ ⁽⁴⁾	450-510 [65-75]	510-590 [75-85]	24-28	54-149 [40-110]
As-Welded with with 90% Argon / 10% CO ₂	480-550 [70-80]	550-620 [80-90]	24-28	54-149 [40-110]

⁽¹⁾Typical all weld metal. ⁽²⁾Measured with 0.2% offset. ⁽³⁾See test results disclaimer ⁽⁴⁾Required gas mixture 75-80% Argon/Balance CO₂ for AWS testing.

DEPOSIT COMPOSITION⁽¹⁾ – As Required per AWS A5.18/A5.36

	%C	%Mn	%Si	%S
Requirements - AWS A5.18: E70C-6M-H8 AWS A5.36: E70T15-M20A2-CS1-H8	0.12 max	1.75 max	0.90 max	0.03 max 0.030 max
Typical Results ⁽²⁾				
As-Welded with 75% Argon / 25% CO ₂ ⁽⁴⁾	0.02-0.05	1.20-1.65	0.50-0.75	0.01-0.02
As-Welded with 90% Argon / 10% CO ₂	0.02-0.05	1.40-1.85	0.50-0.90	0.01-0.02
	%P	%Cu	%Ni	%Cr
Requirements - AWS A5.18: E70C-6M-H8 AWS A5.36: E70T15-M20A2-CS1-H8	0.03 max 0.030 max	0.50 max 0.035 max	0.50 max	0.20 max
Typical Results ⁽²⁾				
As-Welded with 75% Argon / 25% CO ₂ ⁽⁴⁾	0.01-0.02	0.01-0.05	0.02-0.04	0.01-0.04
As-Welded with 90% Argon / 10% CO ₂	0.01-0.02	0.01-0.05	0.02-0.05	0.01-0.04
	%Mo	%V	%Ni + %C + %Mo + %V	Diffusible Hydrogen (mL/100g weld deposit)
Requirements - AWS A5.18: E70C-6M-H8 AWS A5.36: E70T15-M20A2-CS1-H8	0.30 max	0.08 max	0.50 max	8.0 max 8 max
Typical Results ⁽²⁾				
As-Welded with 75% Argon / 25% CO ₂ ⁽⁴⁾	0.01-0.02	0.01-0.02	0.05-0.10	6-8
As-Welded with 90% Argon / 10% CO ₂	0.01-0.02	0.01-0.02	0.05-0.10	

TYPICAL OPERATING PROCEDURES

Diameter, Polarity Shielding Gas	CTWD ⁽³⁾ mm (in)	Wire Feed Speed m/min (in/min)	Voltage ⁽⁵⁾ (volts)	Approx. Current (amps)	Melt-Off Rate kg/hr (lb/hr)	Deposition Rate kg/hr (lb/hr)	Efficiency (%)
0.045 in (1.1 mm), DC+ 90% Argon / 10% CO ₂	19-25 (3/4-1)	5.1 [200]	24-25	165	2.3 [5.1]	2.2 [4.8]	94
		6.4 [250]	25-26	200	2.9 [6.4]	2.8 [6.1]	95
		8.9 [350]	28-29	230	4.1 [9.0]	3.9 [8.6]	95
		11.4 [450]	30-31	310	5.2 [11.5]	5.0 [11.1]	96
		14.0 [550]	32-33	355	6.4 [14.1]	6.2 [13.7]	97
		16.5 [650]	35-36	385	7.6 [16.7]	7.4 [16.2]	97
0.052 in (1.3 mm), DC+ 90% Argon / 10% CO ₂	25-32 (1-1 1/4)	4.4 [175]	23-25	195	2.7 [6.0]	2.5 [5.5]	92
		6.4 [250]	25-27	260	3.9 [8.6]	3.6 [8.0]	93
		8.9 [350]	28-30	330	5.4 [11.9]	5.1 [11.2]	94
		11.4 [450]	31-33	390	7.0 [15.4]	6.6 [14.5]	94
		14.0 [550]	34-36	430	8.5 [18.8]	8.1 [17.8]	95
1/16 in (1.6 mm), DC+ 90% Argon / 10% CO ₂	25-32 (1-1 1/4)	3.8 [150]	24-26	235	3.1 [6.9]	2.9 [6.5]	94
		6.4 [250]	28-30	330	5.2 [11.4]	4.9 [10.8]	95
		8.9 [350]	33-35	410	7.4 [16.3]	7.0 [15.5]	95
		11.4 [450]	35-37	460	9.4 [20.7]	9.0 [19.8]	96

⁽¹⁾Typical all weld metal. ⁽²⁾Measured with 0.2% offset. ⁽³⁾See test results disclaimer. ⁽⁴⁾Required gas mixture 75-80% Argon/Balance CO₂ for AWS testing.

⁽⁵⁾To estimate ESQ, subtract 3/16 in (4.8 mm) from CTWD. ⁽⁶⁾For greater percentage of CO₂ shielding gas, increase voltage by 1-2 volts.

METALSHIELD® Z®

Mild Steel · AWS E70C-GS

KEY FEATURES

- Designed to enhance productivity and quality of single pass lap and fillet welds on galvanized and other zinc coated steels (galvannealed)
- Capable of travel speeds exceeding 55 inches per minute with zero external porosity and less than 1% internal porosity
- Developed for optimal performance with Rapid Z® Waveform Control Technology®
- Reduces both external and internal weld metal porosity inherent to welding coated steel
- Ideal for welding thin gauge material
- Minimizes heat input into the weldment, reducing burn-through potential and minimizing HAZ size
- Able to successfully bridge gaps due to poor fit-up
- Use with DCEN polarity or customized waveforms for optimal productivity and quality

CONFORMANCES

AWS A5: E70C-GS
ISO: T3T Z Z M M20 3, T49 Z TG-0 M20 S A-G

TYPICAL APPLICATIONS

- Automotive
- Coated Steels
- Robotics / Hard Automation
- Single Pass Welds

SHIELDING GAS

90% Argon / 10% CO₂
 Flow rate: 40-50 CFH

WELDING POSITIONS

Flat & Horizontal

DIAMETERS / PACKAGING

Diameter in (mm)	33 lb (15 kg) Fiber Spool	500 lb (227 kg) Accu-Trak® Drum
0.035 (0.9)	ED036258	ED036259
0.040 (1.0)	ED035515	ED035516

MECHANICAL PROPERTIES – As Required per AWS A5.18

	Transverse Tensile Strength MPa [ksi]	Longitudinal Bend Test
Requirements - AWS A5.18: E70C-GS	480 (70) min	180° over 3/4 in Radius
Typical Results ⁽¹⁾ As-Welded with 90% Argon / 10% CO ₂	570 (83)	No openings exceeding 1/8 in

⁽¹⁾Typical all weld metal. ⁽²⁾See test results disclaimer.

DEPOSIT COMPOSITION⁽¹⁾ – As Required per AWS A5.18

	%C	%Mn	%Si	%S	%P	%B
Requirements - AWS A5.18: E70C-GS	Not Specified					
Typical Results ⁽²⁾ As-Welded with 90% Argon / 10% CO ₂	0.07-0.12	1.5-2.1	0.9-1.25	0.02 max	0.015 max	< 0.001

TYPICAL OPERATING PROCEDURES

Diameter, Polarity Shielding Gas	CTWD ⁽³⁾ mm (in)	Wire Feed Speed m/min (in/min)	Voltage (volts)	Approx. Current (amps)	Melt Off Rate kg/hr (lb/hr)	Deposition Rate kg/hr (lb/hr)	Efficiency (%)
0.035 in (0.9 mm), DC- 90% Argon / 10% CO ₂	15-19 {5/8-3/4}	6.4 (250)	21	129	1.7 (3.8)	1.6 (3.6)	95
		10.2 (400)	23	163	2.8 (6.1)	2.8 (6.1)	99
		14.0 (550)	24	191	3.8 (8.3)	3.7 (8.1)	97
0.040 in (1.0 mm), DC- 90% Argon / 10% CO ₂	15-19 {5/8-3/4}	2.5 (100)	19	100	1.0 (2.1)	0.9 (2.0)	95
		10.8 (425)	23	220	3.9 (8.6)	3.8 (8.3)	97
		14.0 (550)	26	265	5.1 (11.2)	5.0 (11.0)	98

⁽¹⁾Typical all weld metal. ⁽²⁾See test results disclaimer. ⁽³⁾To estimate ESO, subtract 3/16 in (4.8 mm) from CTWD.

METALSHIELD® MC-80 XLS™

Low Alloy · AWS E80C-Ni1-H4, E80T15-M21A5-Ni1-H4

KEY FEATURES

- Minimal silicon islands for an exceptionally clean weld surface
- Minimal post weld clean up
- Best-in-class edge wetting for excellent bead appearance
- Smooth, stable arc characteristics with low spatter levels
- Tolerates welding over mill scale and rust
- Low H4 diffusible hydrogen levels
- Designed to accommodate applications requiring Nickel content of 1% max

WELDING POSITIONS

Flat & Horizontal (CV processes)
Out of Position (Pulse waveforms)

CONFORMANCES

- AWS A5:** E80C-Ni1-H4, E80T15-M20A5-Ni1-H4, E80T15-M21A5-Ni1-H4, E80T15-M22A5-Ni1-H4
- CWB/CSA:** E55C-Ni1-H4 (E80C-Ni1-H4)

TYPICAL APPLICATIONS

- Robotics/Hard Automation
- Weathering Grades of the Appropriate Strength ASTM A588 & A709 Steels
- Structural Fabrication
- Heavy Fabrication
- Meets Requirements for NACE Applications

SHIELDING GAS

75-95% Argon / Balance CO₂
95% Argon / Balance O₂
Flow rate: 40-60 CFH

DIAMETERS / PACKAGING

Diameter in (mm)	33 lb (15 kg) Plastic Spool (Vacuum Sealed Foil Bag)	50 lb (22.7 kg) Fiber Spool (Vacuum Sealed Foil Bag)	750 lb (340 kg) Accu-Trak® Drum
0.045 (1.1)	ED037108	ED037478	ED037284
0.052 (1.3)	ED037109	ED037479	ED037285
1/16 (1.6)	ED037110	ED037480	ED037286

MECHANICAL PROPERTIES⁽¹⁾

	Yield Strength ⁽²⁾ MPa (ksi)	Tensile Strength MPa (ksi)	Elongation %	Charpy V-Notch J (ft-lbf) @ -46°C [-50°F]
Requirements AWS A5.28: E80C-Ni1-H4	470 (68) min	550 (80) min	24 min.	27 (20) min
AWS A5.36: E80T15-M20A5-Ni1-H4, E80T15-M21A5-Ni1-H4, E80T15-M22A5-Ni1-H4		550-690 (80-100)	19 min.	
Typical Results ⁽³⁾				
As-Welded with 90% Argon / 10% CO ₂	560-605 (81-88)	640-675 (93-98)	24-26	52-71 (38-52)
As-Welded with 75% Argon / 25% CO ₂	530-580 (77-84)	605-655 (88-95)	24-27	49-71 (36-52)
As-Welded with 95% Argon / 5% O ₂	540-590 (78-86)	630-660 (91-96)	24-26	50-76 (37-56)

⁽¹⁾ Typical all weld metal. ⁽²⁾ Measured with 0.2% offset. ⁽³⁾ See test results disclaimer.

DEPOSIT COMPOSITION⁽¹⁾

	%C	%Mn	%Si	%S	%P	%Cu
Requirements AWS A5.28: E80C-Ni1-H4	0.12 max.	1.50 max.	0.90 max.	0.030 max.	0.025 max.	0.35 max.
AWS A5.36: E80T15-M20A5-Ni1-H4, E80T15-M21A5-Ni1-H4, E80T15-M22A5-Ni1-H4		1.75 max.	0.80 max.		0.030 max.	Not Specified
Typical Performance ⁽²⁾ As-Welded with 90% Argon / 10% CO ₂ As-Welded with 75% Argon / 25% CO ₂ As-Welded with 95% Argon / 5% O ₂	0.04-0.05 0.03-0.06 0.04-0.05	1.42-1.50 1.30-1.40 1.36-1.43	0.69-0.70 0.61-0.65 0.64-0.69	≤ 0.015	≤ 0.008	0.03-0.05 0.03-0.06 0.03-0.05
	%Ni	%Cr	%Mo	%V	%B	Diffusible Hydrogen (mL/100g weld deposit)
Requirements AWS A5.28: E80C-Ni1-H4	0.80-1.10 max.	Not Specified	0.30 max.	0.03 max.	Not Specified	4.0 max.
AWS A5.36: E80T15-M20A5-Ni1-H4, E80T15-M21A5-Ni1-H4, E80T15-M22A5-Ni1-H4		0.15 max.	0.35 max.	0.05 max.		4 max.
Typical Performance ⁽³⁾ As-Welded with 90% Argon / 10% CO ₂ As-Welded with 75% Argon / 25% CO ₂ As-Welded with 95% Argon / 5% O ₂	0.83-0.92 0.82-0.93 0.84-0.93	≤ 0.04	≤ 0.10	≤ 0.01	0.003-0.004	2-4

TYPICAL OPERATING PROCEDURES

Diameter, Polarity Shielding Gas	CTWD ⁽⁴⁾ mm (in)	Wire Feed Speed m/min (in/min)	Voltage ⁽⁵⁾ (volts)	Approx. Current (amps)	Melt-Off Rate kg/hr (lb/hr)	Deposition Rate kg/hr (lb/hr)	Efficiency (%)		
0.045 in (1.1 mm), DC+ 90% Argon / 10% CO ₂	16 - 20 (5/8 - 3/4)	5.1 (200)	21-23	155	2.3 (5.0)	2.1 (4.6)	89		
		6.4 (250)	22-25	185	2.8 (6.2)	2.6 (5.8)	93		
		7.6 (300)	22-26	220	3.5 (7.7)	3.2 (7.0)	90		
		8.9 (350)	22-27	245	4.0 (8.9)	3.7 (8.2)	92		
		10.2 (400)	23-27	260	4.6 (10.1)	4.3 (9.4)	94		
	20 - 25 (3/4 - 1)	12.7 (500)	23-28	305	5.7 (12.6)	5.5 (12.2)	96		
		15.2 (600)	25-29	325	6.8 (15.1)	6.7 (14.8)	96		
		0.052 in (1.3 mm), DC+ 90% Argon / 10% CO ₂	25 - 32 (1 - 1 1/4)	3.6 (150)	22-25	150	2.3 (5.1)	2.1 (4.7)	92
				5.1 (200)	23-26	185	3.0 (6.7)	2.8 (6.2)	93
				6.4 (250)	24-28	210	3.8 (8.4)	3.6 (8.0)	95
7.6 (300)	26-29			240	4.5 (9.9)	4.3 (9.5)	96		
10.2 (400)	27-30			300	6.1 (13.4)	5.8 (12.8)	96		
11.4 (450)	27-30			345	6.8 (15.0)	6.7 (14.8)	99		
12.7 (500)	27-31			380	7.5 (16.6)	7.5 (16.4)	99		
14.0 (550)	28-31	390	8.3 (18.2)	8.2 (18.1)	99				
15.2 (600)	29-32	410	9.0 (19.9)	9.0 (19.8)	99				
1/16 in (1.6 mm), DC+ 90% Argon / 10% CO ₂	25 - 32 (1 - 1 1/4)	3.8 (150)	22-25	235	3.4 (7.5)	3.0 (6.7)	89		
		5.1 (200)	23-26	295	4.4 (9.7)	4.2 (9.2)	95		
		6.4 (250)	24-28	350	5.8 (12.7)	5.4 (11.8)	93		
		7.6 (300)	26-29	395	6.9 (15.2)	6.5 (14.3)	94		
		10.2 (400)	27-30	465	9.2 (20.2)	8.8 (19.3)	96		

⁽¹⁾ See test results disclaimer. ⁽⁴⁾ To estimate ESO, subtract 1/4 in. (6.0 mm) from CTWD. ⁽⁵⁾ For shielding gas blends of 95-99% Argon / Balance O₂, decrease voltage by 1-2 volts.

METALSHIELD® MC®-90

Low Alloy · AWS E90C-K3 H4

KEY FEATURES

- H4 diffusible hydrogen levels
- Low spatter and excellent arc stability
- Deoxidizing agents minimize pre- and post-weld clean up
- Enhanced silicon island management
- Low temperature impact properties – Charpy V-Notch test results capable of exceeding 40 J (30 ft-lbf) @ -51°C [-60°F]
- Excellent bead shape and profile

WELDING POSITIONS

All

SHIELDING GAS

75-90% Argon / Balance CO₂
Flow Rate: 40-60 CFH

CONFORMANCES

AWS A5:	E90C-K3-H4, E90T15-M20A6-K3-H4, E90T15-M21A6-K3-H4
CWB/CSA:	E90C-K3 H4
ISO:	T62 6 T15-0 M A-N3M2 H5

TYPICAL APPLICATIONS

- Robotics/hard automation
- HSLA steels (i.e. ASTM A678 & A710)
- Crane fabrication
- Structural fabrication
- Heavy fabrication
- Power generation

DIAMETERS / PACKAGING

Diameter in (mm)	33 lb (15 kg) Plastic Spool	500 lb (227 kg) Accu-Trak® Drum
0.045 (1.1)	ED033904	ED033907
0.052 (1.3)	ED033905	ED033908
1/16 (1.6)	ED033906	ED033909

MECHANICAL PROPERTIES⁽¹⁾ – As Required per AWS A5.28/A5.36

	Yield Strength ⁽²⁾ MPa (ksi)	Tensile Strength MPa (ksi)	Elongation %	Charpy V-Notch J (ft-lbf)	
				@ -40°C [-40°F]	@ -51°C [-60°F]
Requirements - AWS A5.28: E90C-K3-H4 AWS A5.36: E90T15-M20A6-K3-H4	540 (78) min	620 (90) min 620-760 (90-110)	18 min 17 min	Not Specified	27 (20) min
Typical Results ⁽³⁾					
As-Welded with 75% Argon / 25% CO ₂	585-685 (85-100)	655-755 (95-105)	19-27	60-93 (44-68)	36-87 (27-64)
As-Welded with 90% Argon / 10% CO ₂	585-725 (85-105)	655-825 (95-120)	18-25	41-100 (30-74)	27-91 (20-67)

⁽¹⁾ Typical all weld metal. ⁽²⁾ Measured with 0.2% offset. ⁽³⁾ See test results disclaimer

DEPOSIT COMPOSITION⁽¹⁾ – As Required per AWS A5.28/A5.36

	%C	%Mn	%Si	%S	%P	%Cu
Requirements - AWS A5.28: E90C-K3-H4 AWS A5.36: E90T15-M20A6-K3-H4	0.15 max	0.75-2.25	0.80 max	0.025 max 0.030 max	0.025 max 0.030 max	0.35 max Not Specified
Typical Results ⁽²⁾						
As-Welded with 75% Argon / 25% CO ₂	0.04-0.08	1.00-1.51	0.20-0.35	0.01-0.02	0.01-0.02	0.02-0.06
As-Welded with 90% Argon / 10% CO ₂	0.04-0.08	1.10-1.65	0.20-0.35	0.01-0.02	0.01-0.02	0.03-0.07
	%Ni	%Cr	%Mo	%V	%B	Diffusible Hydrogen (mL/100g weld deposit)
Requirements - AWS A5.28: E90C-K3-H4 AWS A5.36: E90T15-M20A6-K3-H4	0.50-2.50 1.25 - 2.60	0.15 max	0.25-0.65	0.03 max 0.05 max	Not Specified	4.0 max 4 max
Typical Results ⁽³⁾						
As-Welded with 75% Argon / 25% CO ₂	1.50-1.90	0.01-0.10	0.30-0.45	0.01-0.02	0.003-0.004	2.5-4
As-Welded with 90% Argon / 10% CO ₂	1.60-1.90	0.01-0.10	0.30-0.45	0.01-0.02	0.003-0.004	

TYPICAL OPERATING PROCEDURES

Diameter, Polarity Shielding Gas ⁽⁴⁾	CTWD ⁽⁵⁾ mm [in]	Wire Feed Speed m/min [in/min]	Voltage (volts)	Approx. Current (amps)	Melt-Off Rate kg/hr [lb/hr]	Deposition Rate kg/hr [lb/hr]	Efficiency (%)
0.045 in [1.1 mm], DC+ 90% Argon / 10% CO ₂	19-25 (3/4-1)	5.1 [200]	21-23	170	2.4 [5.3]	2.2 [4.7]	89
		6.4 [250]	23-25	195	3.0 [6.7]	2.7 [6.0]	90
		8.9 [350]	25-27	250	4.3 [9.4]	3.8 [8.4]	89
		11.4 [450]	27-29	285	5.4 [11.9]	5.2 [11.4]	96
		14.0 [550]	29-31	330	6.6 [14.5]	6.4 [14.1]	97
		16.6 [650]	31-33	360	7.8 [17.3]	7.7 [16.9]	98
0.052 in [1.3 mm], DC+ 90% Argon / 10% CO ₂	19 - 25 (3/4-1)	5.1 [200]	22-24	225	3.2 [7.1]	2.9 [6.5]	91
		6.4 [250]	24-26	260	4.0 [8.8]	3.6 [7.9]	90
		8.9 [350]	26-28	295	5.6 [12.4]	5.3 [11.8]	95
		11.4 [450]	28-30	345	7.2 [15.9]	7.1 [15.6]	98
		14.0 [550]	30-32	400	8.7 [19.2]	8.6 [18.9]	98
1/16 in [1.6 mm], DC+ 90% Argon / 10% CO ₂	25-32 (1-1 1/4)	5.1 [200]	23-25	260	4.4 [9.7]	4.0 [8.9]	91
		6.4 [250]	26-28	300	5.5 [12.1]	5.2 [11.4]	94
		8.9 [350]	28-30	360	7.7 [16.9]	7.5 [16.5]	98
		11.4 [450]	30-32	420	9.9 [21.8]	9.7 [21.3]	98

⁽¹⁾ Typical all weld metal. ⁽²⁾ Measured with 0.2% offset. ⁽³⁾ See test results disclaimer. ⁽⁴⁾ For greater percentage of CO₂ shielding gas, increase voltage by 1-2 volts. ⁽⁵⁾ To estimate ESO, subtract 3/16 in. [4.8 mm] from CTWD. NOTE: Consult steel manufacturer's recommendations regarding minimum and maximum pre-heat temperature, interpass temperature, and heat input.

METALSHIELD® MC®-110

Low Alloy · AWS E110C-K4 H4

KEY FEATURES

- H4 diffusible hydrogen levels
- Low spatter and excellent arc stability
- Deoxidizing agents minimize pre- and post-weld clean up
- Enhanced silicon island management
- Low temperature impact properties – Charpy V-Notch test results capable of exceeding 40 J [30 ft-lbf] @ -51°C [-60°F]
- Excellent bead shape and profile

WELDING POSITIONS

All

SHIELDING GAS

75-90% Argon / Balance CO₂
Flow Rate: 40-60 CFH

CONFORMANCES

AWS A5:	E110C-K4-H4, E110T15-M20A6-K4-H4, E110T15-M21A6-K4-H4
CWB/CSA:	E110C-K4 H4
ISO:	T76 6 T15-0 M A-N4C1M2 H5

TYPICAL APPLICATIONS

- Robotics/hard automation
- HSLA and quenched and tempered steels (i.e. HY-100 and ASTM 514)
- Crane fabrication
- Heavy Equipment
- Pressure vessels

DIAMETERS / PACKAGING

Diameter in [mm]	33 lb (15 kg) Plastic Spool	500 lb (227 kg) Accu-Trak® Drum
0.045 [1.1]	ED033910	ED033913
0.052 [1.3]	ED033911	ED033914
1/16 [1.6]	ED033912	ED033915

MECHANICAL PROPERTIES⁽¹⁾ – As Required per AWS A5.28/A5.36

	Yield Strength ⁽²⁾ MPa [ksi]	Tensile Strength MPa [ksi]	Elongation %	Charpy V-Notch J [ft-lbf]	
				@ -40°C [-40°F]	@ -51°C [-60°F]
Requirements - AWS A5.28: E110C-K4-H4 AWS A5.36: E110T15-M20A6-K4-H4	680 [98] min	760 [110] min 760-900 [110-130]	15 min	Not Specified	27 [20] min
Typical Results ⁽³⁾					
As-Welded with 75% Argon / 25% CO ₂	690-795 [100-115]	760-825 [110-120]	20-24	60-88 [44-65]	45-80 [34-59]
As-Welded with 90% Argon / 10% CO ₂	725-825 [105-120]	790-895 [115-130]	18-23	66-95 [48-70]	59-82 [44-61]

⁽¹⁾ Typical all weld metal. ⁽²⁾ Measured with 0.2% offset. ⁽³⁾ See test results disclaimer

DEPOSIT COMPOSITION⁽¹⁾ – As Required per AWS A5.28/A5.36

	%C	%Mn	%Si	%S	%P	%Cu
Requirements - AWS A5.28: E110C-K4-H4 AWS A5.36: E110T15-M20A6-K4-H4	0.15 max	0.75-2.25 1.20 - 2.25	0.80 max	0.025 max 0.030 max	0.025 max 0.030 max	0.35 max Not Specified
Typical Results ⁽²⁾						
As-Welded with 75% Argon / 25% CO ₂	0.05-0.08	1.45-1.75	0.45-0.65	0.01-0.02	0.01-0.02	0.02-0.06
As-Welded with 90% Argon / 10% CO ₂	0.05-0.08	1.45-1.75	0.45-0.65	0.01-0.02	0.01-0.02	0.02-0.06
	%Ni	%Cr	%Mo	%V	Diffusible Hydrogen (mL/100g weld deposit)	
Requirements - AWS A5.28: E110C-K4-H4 AWS A5.36: E110T15-M20A6-K4-H4	0.50-2.50 1.75 - 2.60	0.15-0.65 0.20 - 0.60	0.25-0.65 0.20 - 0.65	0.03 max	4.0 max 4 max	
Typical Results ⁽³⁾						
As-Welded with 75% Argon / 25% CO ₂	2.00-2.20	0.20-0.35	0.45-0.55	0.01-0.02	2.5-4	
As-Welded with 90% Argon / 10% CO ₂	2.00-2.20	0.20-0.35	0.45-0.55	0.01-0.02		

TYPICAL OPERATING PROCEDURES

Diameter, Polarity Shielding Gas ⁽⁴⁾	CTWD ⁽⁵⁾ mm [in]	Wire Feed Speed m/min [in/min]	Voltage [volts]	Approx. Current [amps]	Melt-Off Rate kg/hr [lb/hr]	Deposition Rate kg/hr [lb/hr]	Efficiency [%]
0.045 in [1.1 mm], DC+ 90% Argon / 10% CO ₂	19-25 [3/4-1]	5.1 [200]	22-24	170	2.4 [5.3]	2.1 [4.7]	88
		6.4 [250]	24-26	190	3.0 [6.7]	2.8 [6.1]	91
		8.9 [350]	26-28	240	4.2 [9.2]	3.8 [8.4]	91
		11.4 [450]	28-30	290	5.4 [11.8]	5.1 [11.3]	95
		14.0 [550]	30-32	330	6.5 [14.4]	6.3 [13.9]	97
		16.6 [650]	31-33	370	7.8 [17.1]	7.6 [16.7]	97
0.052 in [1.3 mm], DC+ 90% Argon / 10% CO ₂	19-25 [3/4-1]	5.1 [200]	23-25	225	3.2 [7.0]	2.8 [6.2]	89
		6.4 [250]	25-27	255	4.0 [8.8]	3.7 [8.1]	92
		8.9 [350]	27-29	295	5.5 [12.2]	5.3 [11.6]	95
		11.4 [450]	29-31	350	7.2 [15.8]	7.0 [15.4]	98
		14.0 [550]	31-33	400	8.7 [19.1]	8.5 [18.8]	98
1/16 in [1.6 mm], DC+ 90% Argon / 10% CO ₂	25-32 [1-1 1/4]	5.1 [200]	24-26	270	4.4 [9.6]	3.9 [8.6]	89
		6.4 [250]	26-28	320	5.4 [12.1]	5.1 [11.3]	94
		8.9 [350]	28-30	385	7.7 [16.9]	7.4 [16.4]	97
		11.4 [450]	30-32	465	9.8 [21.6]	9.6 [21.2]	98

⁽¹⁾ Typical all weld metal. ⁽²⁾ Measured with 0.2% offset. ⁽³⁾ See test results disclaimer. ⁽⁴⁾ For greater percentage of CO₂, shielding gas, increase voltage by 1-2 volts. ⁽⁵⁾ To estimate ESO, subtract 3/16 in. [4.8 mm] from CTWD. NOTE: Consult steel manufacturer's recommendations regarding minimum and maximum pre-heat temperature, interpass temperature, and heat input.

METALSHIELD® MC®-120

Low Alloy · AWS E120C-K4-H4, E120T15-M20A6-K4-H4

KEY FEATURES

- H4 diffusible hydrogen levels
- Low spatter and excellent arc stability
- Deoxidizing agents minimize pre- and post-weld clean up
- Enhanced silicon island management
- Low temperature impact properties – Charpy V-Notch test results capable of exceeding 27 J [20 ft-lbf] @ -51°C [-60°F]
- Excellent bead shape and profile

WELDING POSITIONS

All

SHIELDING GAS

75-90% Argon / Balance CO₂
Flow Rate: 40-60 CFH

CONFORMANCES

AWS A5: E120C-K4-H4, E120T15-M20A6-K4-H4

TYPICAL APPLICATIONS

- Robotics/hard automation
- HSLA and quenched and tempered steels (i.e. HY-100 and ASTM A514)
- Crane fabrication
- Heavy Equipment
- Pressure vessels

DIAMETERS / PACKAGING

Diameter in [mm]	33 lb (15 kg) Plastic Spool
0.052 [1.3]	ED036480

MECHANICAL PROPERTIES⁽¹⁾

	Yield Strength ⁽²⁾ MPa (ksi)	Tensile Strength MPa (ksi)	Elongation %	Charpy V-Notch J [ft-lbf]	
				@ -40°C [-40°F]	@ -51°C [-60°F]
Requirements - AWS A5.28: E120C-K4-H4 AWS A5.36: E120T15-M20A6-K4-H4	750 [108] min 740 [108] min	830 [120] min 830-970 [120-140]	15 min 14 min	Not Specified	27 [20] min
Typical Results ⁽³⁾					
As-Welded with 75% Argon / 25% CO ₂	790-800 [115-116]	855-860 [124-125]	22	60-70 [45-52]	40-45 [31-34]
As-Welded with 90% Argon / 10% CO ₂	820-860 [119-125]	880-915 [128-133]	21	50-70 [39-55]	45-46 [32-34]

⁽¹⁾ Typical all weld metal. ⁽²⁾ Measured with 0.2% offset. ⁽³⁾ See test results disclaimer

DEPOSIT COMPOSITION⁽¹⁾

	%C	%Mn	%Si	%S	%P	%Cu
Requirements - AWS A5.28: E120C-K4-H4 AWS A5.36: E120T15-M20A6-K4-H4	0.15 max	0.75-2.25 1.20 - 2.25	0.80 max	0.025 max 0.030 max	0.025 max 0.030 max	0.35 max Not Specified
Typical Results ⁽²⁾						
As-Welded with 75% Argon / 25% CO ₂	0.06 - 0.07	1.70 - 1.80	0.58 - 0.62	0.010	0.010	0.02
As-Welded with 90% Argon / 10% CO ₂	0.06 - 0.08	1.80 - 1.90	0.60 - 0.66	0.020		0.02 - 0.03
	%Ni	%Cr	%Mo	%V	Diffusible Hydrogen (mL/100g weld deposit)	
Requirements - AWS A5.28: E120C-K4-H4 AWS A5.36: E120T15-M20A6-K4-H4	0.50-2.50 1.75 - 2.60	0.15-0.65 0.20 - 0.60	0.25-0.65 0.20 - 0.65	0.03 max	4.0 max 4 max	
Typical Results ⁽³⁾						
As-Welded with 75% Argon / 25% CO ₂			0.55 - 0.58	0.01	1.0 - 3.0	
As-Welded with 90% Argon / 10% CO ₂	1.90 - 2.10	0.31 - 0.33	0.56 - 0.63			

TYPICAL OPERATING PROCEDURES

Diameter, Polarity Shielding Gas ⁽⁴⁾	CTWD ⁽⁵⁾ mm [in]	Wire Feed Speed m/min [in/min]	Voltage [volts]	Approx. Current [amps]	Melt-Off Rate kg/hr [lb/hr]	Deposition Rate kg/hr [lb/hr]	Efficiency [%]
0.052 in (1.3 mm), DC+ 90% Argon / 10% CO ₂	19-25 [3/4-1]	5.1 [200]	23-25	200	3.1 [6.8]	2.9 [6.5]	96
		6.4 [250]	25-27	230	3.9 [8.5]	3.7 [8.1]	95
		8.9 [350]	27-29	320	5.8 [12.7]	5.4 [11.8]	93
		11.4 [450]	29-31	370	7.3 [16.1]	7.2 [15.8]	98
		14.0 [550]	31-33	420	9.0 [19.8]	8.7 [19.2]	97

⁽¹⁾ Typical all weld metal. ⁽²⁾ Measured with 0.2% offset. ⁽³⁾ See test results disclaimer. ⁽⁴⁾ For greater percentage of CO₂ shielding gas, increase voltage by 1-2 volts. ⁽⁵⁾ To estimate ESO, subtract 3/16 in. (4.8 mm) from CTWD.

FCAW-S & FCAW-G CONSUMABLES

FLUX-CORED



INNERSHIELD® NR®-5

Mild Steel, Flat & Horizontal · AWS E70T-3,

KEY FEATURES

- Fast travel speeds
- Increased resistance to porosity
- Consistent bead appearance

WELDING POSITIONS

Flat & Horizontal

MAXIMUM PLATE THICKNESS

Diameter - in (mm)	Maximum Plate Thickness - in (mm)
3/32 [2.4]	3/16 [4.8]
0.120 [3.0]	3/16 [4.8]

CONFORMANCES

AWS A5: E70T-3

TYPICAL APPLICATIONS

- Single pass welding on up to 48 mm (3/16 in) thicknesses
- 3 o'clock welding positions
- Welds with copper back-up
- Propane cylinders
- Robotics/hard automation

WARNING

- NR-5 IS NOT RECOMMENDED FOR WELDING MULTIPLE PASSES

DIAMETERS / PACKAGING

Diameter in (mm)	600 lb [272 kg] Speed-Feed® Reel	600 lb [272 kg] Speed-Feed® Drum
3/32 [2.4]	ED012698	ED012699
0.120 [3.0]		

MECHANICAL PROPERTIES⁽¹⁾

	Transverse Tensile Strength MPa (ksi)	Longitudinal Bend Test	Hardness Rockwell B
Requirements - AWS E70T-3	480 (70) min	180° over 3/4 in Radius No openings exceeding 1/8 in	–
Typical Results ⁽²⁾	505-560 (75-80)	Passed	99

DEPOSIT COMPOSITION⁽¹⁾

	%C	%Mn	%Si	%S	%P	%Al	%Ti
Requirements - AWS E70T-3	Not Specified						
Typical Results ⁽²⁾	0.17-0.22	0.95-1.11	0.34-0.40	0.008-0.02	0.01-0.02	0.07-0.12	0.40-0.49

TYPICAL OPERATING PROCEDURES

Diameter, Polarity	CTWD mm (in)	Wire Feed Speed m/min (in/min)	Voltage (volts)	Approx. Current (amps)	Melt-Off Rate kg/hr (lb/hr)	Deposition Rate kg/hr (lb/hr)	Efficiency (%)
3/32 in (2.4 mm), DC+	32 (1-1/4)	2.5 [100]	22-23	340	4.5 [9.9]	3.5 [7.8]	77
		3.8 [150]	23-24	435	6.7 [14.8]	5.6 [12.3]	83
		5.1 [200]	24-25	510	9.0 [19.8]	7.7 [16.9]	85
		6.4 [250]	25-26	575	11.2 [24.7]	9.7 [21.4]	87
0.120 in (3.0 mm), DC+	32 (1-1/4)	3.3 [130]	22-23	500	8.2 [18.0]	7.6 [16.7]	93
		4.2 [165]	23-24	600	10.4 [23.0]	9.5 [20.9]	91
		6.5 [205]	24-25	700	12.9 [28.5]	11.6 [25.6]	90
		6.5 [255]	25-26	800	16.1 [35.5]	14.3 [31.5]	90

⁽¹⁾Typical all weld metal. ⁽²⁾See test results disclaimer

INNERSHIELD® NR®-131

Mild Steel, Flat & Horizontal • AWS E70T-10

KEY FEATURES

- Fast travel speeds and high deposition rates
- Maximum penetration
- Flat bead profile on butt welds
- Join dissimilar plate thicknesses with even heat distribution

WELDING POSITIONS

Flat & Horizontal

CONFORMANCES

AWS A5: E70T-10

TYPICAL APPLICATIONS

- Single pass welding on up to 2.8 mm (0.110 in) thicknesses
- Sheet metal
- Automotive

WARNING

- NR-131 IS NOT RECOMMENDED FOR WELDING MULTIPLE PASSES

DIAMETERS / PACKAGING

Diameter in (mm)	600 lb (272 kg) Speed-Feed® Reel
3/32 (2.4)	ED012163

MECHANICAL PROPERTIES⁽¹⁾

	Transverse Tensile Strength MPa (ksi)	Longitudinal Bend Test	Hardness Rockwell B
Requirements - AWS E70T-10	480 (70) min	180° over 3/4 in Radius No openings exceeding 1/8 in	–
Typical Results ⁽²⁾	505-560 (75-80)	Passed	99

DEPOSIT COMPOSITION⁽¹⁾

	%C	%Mn	%Si	%S	%P	%Al
Requirements - AWS E70T-10	Not Specified					
Typical Results ⁽²⁾	0.22-0.26	0.42-0.65	0.20-0.27	0.005-0.007	0.007-0.02	1.18-1.49

TYPICAL OPERATING PROCEDURES

Diameter, Polarity	CTWD mm (in)	Wire Feed Speed m/min (in/min)	Voltage (volts)	Approx. Current (amps)	Melt-Off Rate kg/hr (lb/hr)	Deposition Rate kg/hr (lb/hr)	Efficiency (%)
3/32 in (2.4 mm), Single Arc, DC-	38 (1-1/2)	3.8 (150)	25-26	390	6.5 (14.3)	5.3 (11.6)	81
		5.1 (200)	25-27	490	8.6 (19.0)	7.1 (15.6)	82
		6.4 (250)	26-27	570	10.8 (23.7)	8.9 (19.6)	82
		8.9 (350)	26-28	720	15.0 (33.1)	33.6 (27.6)	83
		10.8 (425)	27-28	810	18.2 (40.1)	15.2 (33.6)	83
3/32 in (2.4 mm), Twinarc, DC-	44 (1-3/4)	3.3 (130)	25-26	550	11.1 (24.5)	8.1 (17.9)	72
		4.4 (175)	26-27	740	15.0 (33.0)	12.0 (26.4)	79
		5.7 (225)	26-28	910	19.3 (42.5)	15.8 (34.8)	81
		7.0 (275)	27-29	1030	23.5 (51.9)	19.1 (42.0)	80
		8.3 (325)	28-30	1090	27.9 (61.4)	21.9 (48.2)	78

⁽¹⁾Typical all weld metal. ⁽²⁾See test results disclaimer

INNERSHIELD® NR[®]-305

Mild Steel, Flat & Horizontal · AWS E70T-6

KEY FEATURES

- High deposition rates in the flat and horizontal positions
- Smooth arc and low spatter levels
- Capable of producing weld deposits with impact properties exceeding 27 J (20 ft-lbf) at -29°C (-20°F)
- Welds on lightly rusted or primed plate
- Meets AWS D1.8 seismic lot waiver requirements

CONFORMANCES

AWS A5:	E70T-6-H8, E70T-6-H16 for 3/32" only
ABS:	2YSA E70T-6-H10, 2YSA H10 for 5/64" only
DNV:	II YMS
AWS D1.8:	5/64", 3/32"
ISO:	T 42 0 W N 3 H15 T42 0 W NO 3 H15
JIS Z 3313:	T49 3 T6-0 N A

WELDING POSITIONS

Flat & Horizontal

TYPICAL APPLICATIONS

- General plate fabrication
- Structural fabrication, including those subject to seismic requirements
- Bridges and offshore rigs
- Shipyards, stiffener welding on barges
- Welding over tack welds made with stick electrode

DIAMETERS / PACKAGING

Diameter in (mm)	25 lb (11.3 kg) Steel Spool	25 lb (11.3 kg) Plastic Spool (Vacuum Sealed Foil Bag)	50 lb (22.7 kg) Coil	50 lb (22.7 kg) 50 lb Coil (Vacuum Sealed Foil Bag)
5/64 [2.0] 3/32 [2.4]	ED034185	ED030971	ED012593	ED030005

MECHANICAL PROPERTIES⁽¹⁾

	Yield Strength ⁽²⁾ MPa (ksi)	Tensile Strength MPa (ksi)	Elongation %	Hardness Rockwell B	Charpy V-Notch J (ft-lbf) @ -29°C (-20°F)
Requirements - AWS E70T-6	400 [58] min	480-655 [70-95]	22 min	—	27 [20] min
Typical Results⁽³⁾ - As-Welded	465-535 [68-77]	565-620 [82-90]	24-28	88-93	27-41 [20-30]

DEPOSIT COMPOSITION⁽¹⁾

	%C	%Mn	%Si	%S	%P	%Al
Requirements - AWS E70T-6	0.30 max	1.75 max	0.60 max	0.03 max	0.03 max	1.8 max
Typical Results⁽³⁾	0.06-0.09	1.08-1.57	0.20-0.27	≤0.01	≤0.01	0.9-1.1

TYPICAL OPERATING PROCEDURES

Diameter, Polarity	CTWD mm (in)	Wire Feed Speed m/min (in/min)	Voltage [volts]	Approx. Current [amps]	Melt-Off Rate kg/hr (lb/hr)	Deposition Rate kg/hr (lb/hr)	Efficiency [%]
5/64 in [2.0 mm], DC+	35-51 (1 3/8-2)	4.4 [175]	20-22	300	8.5 [10.5]	4.0 [8.8]	84
		5.6 [220]	21-23	330	6.0 [13.3]	5.0 [11.1]	83
		6.6 [260]	22-24	360	7.1 [15.7]	5.9 [13.1]	83
		7.6 [300]	24-26	375	8.2 [18.1]	6.9 [15.2]	84
		8.3 [325]	25-27	400	8.9 [19.7]	7.4 [16.4]	83
3/32 in [2.4 mm], DC+	41-54 (1 5/8-2 1/4) ⁽⁴⁾	4.1 [160]	21-23	330	6.0 [13.3]	5.0 [11.0]	82
		6.1 [240]	24-26	425	9.1 [20.0]	7.6 [16.7]	83
		7.6 [300]	27-29	475	11.3 [25.0]	9.5 [21.0]	84
		10.2 [400]	33-35	525	15.2 [33.4]	12.7 [28.0]	83

⁽¹⁾Typical all weld metal. ⁽²⁾Measured with 0.2% offset. ⁽³⁾See test results disclaimer. ⁽⁴⁾Use CTWD of 2 1/4 in [54 mm] for wire feed speeds greater than 300 ipm.
NOTE: FEMA 353 and AWS D1.8 structural steel seismic supplement test data can be found on this product at www.lincolnelectric.com.

INNERSHIELD® NR[®]-311

Mild Steel, Flat & Horizontal · AWS E70T-7

KEY FEATURES

- High deposition rates and fast travel speeds
- Easy slag removal
- Optimal toe wash-in
- Deep penetration
- High resistance to cracking
- Welds on lightly rusted or primed plate

WELDING POSITIONS

Flat & Horizontal

CONFORMANCES

- AWS A5:** E70T-7
ABS: 2YSA for 5/64" - 7/64"
CWB/CSA: E490T7-AZ-CS3 E492T-7

TYPICAL APPLICATIONS

- Recommended for fillet, lap and butt welds on 3.2 mm (1/8 in) and thicker steel, including some low alloy steels
- General fabrication
- Assembly welding

DIAMETERS / PACKAGING

Diameter in (mm)	14 lb [6.4 kg] Coil 56 lb [25.4 kg] Master Carton	25 lb [11.3 kg] Steel Spool	50 lb [22.7 kg] Coil	600 lb [272 kg] Speed-Feed [®] Reel	600 lb [272 kg] Speed-Feed [®] Drum
5/64 [2.0]	ED014464	ED030649	ED014459 ED012629 ED012632	ED012633	ED012628
3/32 [2.4]					
7/64 [2.8]					

MECHANICAL PROPERTIES⁽¹⁾

	Yield Strength ⁽²⁾ MPa (ksi)	Tensile Strength MPa (ksi)	Elongation %	Hardness Rockwell B
Requirements - AWS E70T-7	400 (58) min	480-655 (70-95)	22 min	—
Typical Results⁽³⁾ - As-Welded	420-475 (61-69)	600-645 (87-93)	23-26	88-92

DEPOSIT COMPOSITION⁽¹⁾

	%C	%Mn	%Si	%S	%P	%Al
Requirements - AWS E70T-7	0.30 max	1.75 max	0.60 max	0.03 max	0.03 max	1.8 max
Typical Results⁽³⁾	0.25-0.29	0.44-0.51	0.09-0.12	≤0.01	≤0.01	1.4-1.7

TYPICAL OPERATING PROCEDURES

Diameter, Polarity	CTWD mm (in)	Wire Feed Speed m/min (in/min)	Voltage (volts)	Approx. Current (amps)	Melt-Off Rate kg/hr (lb/hr)	Deposition Rate kg/hr (lb/hr)	Efficiency (%)
5/64 in (2.0 mm), DC-	38 (1 1/2)	2.5 (100)	20-23	190	2.9 (6.4)	2.3 (5.0)	78
		4.1 (160)	24-28	275	4.7 (10.3)	3.6 (8.0)	78
		6.1 (240)	25-29	355	7.0 (15.4)	5.6 (12.4)	80
		7.6 (300)	27-31	410	8.8 (19.3)	7.2 (15.8)	82
3/32 in (2.4 mm), DC-	45 (1 3/4)	1.9 (75)	20-23	200	3.2 (7.0)	2.5 (5.4)	77
		3.4 (135)	23-26	300	5.9 (13.1)	4.6 (10.2)	78
		3.8 (150)	24-27	325	6.6 (14.6)	5.2 (11.4)	78
		5.3 (210)	26-28	400	9.3 (20.4)	7.5 (16.5)	81
		6.9 (270)	28-30	450	11.9 (26.2)	10.0 (22.0)	84
7/64 in (2.8 mm), DC-	45 (1 3/4)	2.5 (100)	23-26	325	5.4 (12.0)	4.5 (10.0)	83
		3.7 (145)	25-27	400	8.1 (17.8)	6.6 (14.5)	82
		4.4 (175)	26-28	450	9.8 (21.5)	8.2 (18.0)	83
		6.1 (240)	30-32	550	13.4 (29.5)	11.6 (25.5)	86
		7.6 (300)	32-34	625	16.7 (36.9)	15.0 (33.0)	89

⁽¹⁾Typical all weld metal. ⁽²⁾Measured with 0.2% offset. ⁽³⁾See test results disclaimer

INNERSHIELD® NS-3M

Mild Steel, Flat & Horizontal · AWS E70T-4

KEY FEATURES

- Very high deposition rates
- Increased resistance to hot cracking and porosity
- Soft, low penetrating arc for minimal base material admixture

CONFORMANCES

- AWS A5:** E70T-4
- CWB/CSA:** E490T4-AZ-CS3-H16 E492T-4-H16
- ISO:** T49 Z T4-0 NO A H15, 17632-A: T 38 Z V N 3

TYPICAL APPLICATIONS

- Open groove welds
- Machinery bases and heavy equipment repair
- Installing wear plates
- 6.4 - 12.7 mm (1/4 - 1/2 in) single pass fillet and lap welds

WELDING POSITIONS

Flat & Horizontal

DIAMETERS / PACKAGING

Diameter in (mm)	14 lb (6.4 kg) Coil 56 lb (25.4 kg) Master Carton	50 lb (22.7 kg) Coil	600 lb (272 kg) Speed-Feed® Drum
5/64 (2.0)	ED012739	ED012740	
3/32 (2.4)		ED012736	ED012735
0.120 (3.0)		ED012732	ED012731

MECHANICAL PROPERTIES⁽¹⁾

	Yield Strength ⁽²⁾ MPa (ksi)	Tensile Strength MPa (ksi)	Elongation %	Hardness Rockwell B
Requirements - AWS E70T-4	400 (58) min	480-655 (70-95)	22 min	—
Typical Results⁽³⁾ - As-Welded	415-450 (60-65)	580-620 (84-90)	25-28	87-91

DEPOSIT COMPOSITION⁽¹⁾

	%C	%Mn	%Si	%S	%P	%Al
Requirements - AWS E70T-4	0.30 max	1.75 max	0.60 max	0.03 max	0.03 max	1.8 max
Typical Results⁽³⁾	0.21-0.25	0.37-0.53	0.25-0.29	≤0.01	≤0.01	1.3-1.6

TYPICAL OPERATING PROCEDURES

Diameter, Polarity	CTWD mm (in)	Wire Feed Speed m/min (in/min)	Voltage (volts)	Approx. Current (amps)	Melt-Off Rate kg/hr (lb/hr)	Deposition Rate kg/hr (lb/hr)	Efficiency (%)
5/64 in (2.0 mm), DC+	54 (2 1/4)	5.1 (200)	29-31	280	5.5 (12.2)	4.6 (10.1)	83
		6.1 (240)	30-32	315	6.7 (14.8)	5.5 (12.1)	82
		6.6 (260)	30-32	330	7.3 (16.0)	6.0 (13.2)	83
		7.6 (300)	31-33	350	8.4 (18.6)	6.9 (15.2)	82
3/32 in (2.4 mm), DC+	76 (3)	2.8 (110)	28-30	250	4.6 (10.1)	3.7 (8.2)	81
		3.8 (150)	29-31	300	6.4 (14.0)	5.3 (11.7)	84
		4.7 (185)	30-32	350	7.9 (17.4)	6.6 (14.6)	84
		5.8 (230)	31-33	400	9.8 (21.6)	8.3 (18.3)	85
7.0 (275)	32-34	450	11.8 (26.0)	10.0 (22.0)	85		
0.120 in (3.0 mm), DC+ Electrical Stickout: 2 - 3/4 in (70 mm)	76 (3)	3.5 (140)	28-30	380	9.0 (19.8)	7.0 (15.5)	78
		4.4 (175)	29-31	450	11.2 (24.6)	9.1 (20.0)	81
		5.1 (200)	30-32	500	12.7 (28.0)	10.5 (23.2)	83
		7.6 (225)	31-33	550	14.2 (31.4)	11.9 (26.2)	83
0.120 in (3.0 mm), DC+ Electrical Stickout: 3 - 3/4 in (95 mm)	102 (4)	5.3 (210)	35-37	450	13.2 (29.0)	11.3 (25.0)	86
		6.4 (250)	36-38	500	15.6 (34.5)	13.2 (29.0)	84
		7.6 (300)	37-39	550	18.8 (41.5)	15.4 (34.0)	82
		9.0 (355)	38-40	600	22.2 (49.0)	18.0 (39.5)	81

⁽¹⁾Typical all weld metal. ⁽²⁾Measured with 0.2% offset. ⁽³⁾See test results disclaimer

INNERSHIELD® NR® -311 Ni

Low Alloy, Flat & Horizontal · AWS E70T7-K2, E80TG-K2

KEY FEATURES

- Designed to provide a nominal 1.5% nickel weld deposit
- High deposition rates and fast travel speeds
- Capable of producing weld deposits with impact properties exceeding 27 J (20 ft-lbf) at -29°C (-20°F)
- Color match on weathering steel applications
- 3/32 in (2.4 mm) diameter meets AWS D1.8 seismic lot waiver requirements

TYPICAL APPLICATIONS

- Fillet and lap welds
- Horizontal and square edge butt welds, such as column-to-column structural connections
- Deep groove welds
- Structural fabrication
- Weathering steels

DIAMETERS / PACKAGING

Diameter in (mm)	25 lb (11.3 kg) Steel Spool	50 lb (22.7 kg) Coil	50 lb (22.7 kg) Coil (Vacuum Sealed Foil Bag)
5/64 (2.0)	ED030650	ED017822 ED017824	ED032530
3/32 (2.4)			
7/64 (2.8)			

MECHANICAL PROPERTIES⁽¹⁾

	Yield Strength ⁽²⁾ MPa (ksi)	Tensile Strength MPa (ksi)	Elongation %	Hardness Rockwell B	Charpy V-Notch J (ft-lbf) @ -29°C [-20°F]
Requirements AWS E70T7-K2 AWS E80TG-K2	400 (58) min 470 (68) min	480-620 (70-90) 550-690 (80-100)	20 min 19 min	–	27 (20) min Not Specified
Typical Results⁽³⁾ As-Welded	470-515 (68-75)	575-615 (83-89)	27-30	88-93	41-87 (30-65)

DEPOSIT COMPOSITION⁽¹⁾

	%C	%Mn	%Si	%S	%P	%Ni	%Cr	%Mo	%V	%Al
Requirements - AWS E70T7-K2 / E80TG-K2	0.15 max	0.50-1.75	0.80 max	0.030 max	0.030 max	1.00-2.00	0.15 max	0.35 max	0.05 max	1.8 max
Typical Results⁽³⁾	0.06-0.08	1.25-1.40	0.18-0.22	≤0.003	0.005-0.008	1.29-1.56	0.03-0.04	≤0.03	–	1.0-1.3

TYPICAL OPERATING PROCEDURES

Diameter, Polarity	CTWD mm (in)	Wire Feed Speed m/min (in/min)	Voltage (volts)	Approx. Current (amps)	Melt-Off Rate kg/hr (lb/hr)	Deposition Rate kg/hr (lb/hr)	Efficiency (%)
5/64 in (2.0 mm), DC-	32 (1 1/4)	2.5 (100)	21-23	170	2.5 (5.5)	1.8 (3.9)	70
		3.3 (130)	24-26	205	3.3 (7.2)	2.4 (5.2)	72
		4.1 (160)	25-27	235	4.0 (8.8)	2.9 (6.5)	73
		5.1 (200)	26-28	270	5.0 (11.0)	3.8 (8.3)	75
		6.1 (240)	27-29	295	6.1 (13.3)	4.5 (10.0)	75
3/32 in (2.4 mm), DC-	38 (1 1/2)	1.9 (75)	20-22	200	2.8 (6.2)	1.9 (4.2)	67
		2.5 (100)	21-23	245	3.8 (8.3)	2.7 (5.9)	71
		3.1 (125)	23-25	285	4.7 (10.4)	3.4 (7.5)	72
		3.8 (150)	25-27	330	5.7 (12.5)	4.1 (9.1)	72
		4.4 (175)	26-28	365	6.6 (14.5)	4.9 (10.8)	74
5.1 (200)	27-29	390	7.6 (16.6)	5.6 (12.3)	74		
7/64 in (2.8 mm), DC-	44.5 (1 3/4)	2.5 (100)	22-24	310	5.2 (11.4)	3.8 (8.4)	73
		3.5 (140)	24-26	370	7.2 (15.8)	5.4 (11.8)	74
		4.3 (170)	26-28	430	8.9 (19.5)	6.6 (14.5)	74
		5.1 (200)	28-30	470	10.4 (22.8)	7.7 (17.0)	74
		6.1 (240)	29-31	520	12.4 (27.2)	9.2 (20.4)	75

⁽¹⁾Typical all weld metal. ⁽²⁾Measured with 0.2% offset. ⁽³⁾See test results disclaimer

NOTE: FEMA and AWS D1.8 structural steel seismic supplement test data can be found on this product at www.lincolnelectric.com.

CONFORMANCES

AWS A5:	E70T7-K2-H16, E80TG-K2-H16
ABS:	2YSA
DNV:	II YMS
Lloyd's Register:	2YS
BV:	SA2YM
AWS D1.8:	3/32"
ISO:	T 42 2 1,5Ni W N 5

WELDING POSITIONS

Flat & Horizontal

INNERSHIELD® NR®-152

Mild Steel, All Position · AWS E71T-14

KEY FEATURES

- Designed for high speed welding of specially coated steels
- Soft, consistent arc
- Porosity resistant
- Excellent overlapping capabilities
- Ideal for robotic applications

WELDING POSITIONS

All

MAXIMUM PLATE THICKNESS

Diameter - in (mm)	Maximum Plate Thickness - in (mm)
1/16 (1.6)	3/16 (4.8)
0.068 (1.7)	3/16 (4.8)

DIAMETERS / PACKAGING

Diameter in (mm)	25 lb (11.3 kg) Plastic Spool	50 lb (22.7 kg) Coil	500 lb (227 kg) Speed-Feed® Drum	500 lb (227 kg) Accu-Trak® Drum
0.045 (1.1)	EDS01702	ED012185 ED012186	ED024301	ED028123 ED029066
0.062 (1.6)				
0.068 (1.7)				

MECHANICAL PROPERTIES⁽¹⁾

	Transverse Tensile Strength MPa (ksi)	Longitudinal Bend Test	Hardness Rockwell B
Requirements - AWS E71T-14	480 (70) min	180° over 3/4 in Radius / No openings exceeding 1/8 in	—
Typical Results ⁽²⁾	480-550 (70-80)	Passed	93

DEPOSIT COMPOSITION⁽¹⁾

	%C	%Mn	%Si	%S	%P	%Al
Requirements - AWS E71T-14	Not Specified					
Typical Results ⁽²⁾	0.25-0.30	0.83-1.04	0.20-0.23	0.006-0.01	0.005-0.02	1.08-1.38

TYPICAL OPERATING PROCEDURES

Diameter, Polarity	CTWD mm (in)	Wire Feed Speed m/min (in/min)	Voltage (volts)	Approx. Current (amps)	Melt-Off Rate kg/hr (lb/hr)	Deposition Rate kg/hr (lb/hr)	Efficiency (%)
1/16 in (1.6 mm), DC-	16 (5/8)	0.8 (30)	13-14	90	0.5 (1.3)	0.5 (1.2)	92
		1.0 (40)	14-15	115	0.8 (1.8)	0.7 (1.6)	88
		1.3 (50)	15-16	140	0.9 (2.2)	0.9 (2.0)	90
		1.8 (70)	16-17	185	1.4 (3.1)	1.3 (2.8)	90
		2.8 (110)	19-20	265	2.1 (4.8)	2.0 (4.4)	91
0.068 in (1.7 mm), DC-	19 (3/4)	0.8 (30)	13-14	68	0.7 (1.6)	0.6 (1.4)	87
		1.0 (40)	13-14	95	0.9 (2.2)	0.9 (1.9)	86
		1.3 (50)	14-15	120	1.2 (2.7)	1.1 (2.4)	88
		1.5 (60)	15-16	145	1.4 (3.3)	1.3 (2.9)	87
		2.0 (80)	16-17	190	1.9 (4.4)	1.8 (3.9)	88
2.8 (110)	20-21	240	2.7 (6.0)	2.4 (5.4)	90		

⁽¹⁾Typical all weld metal. ⁽²⁾See test results disclaimer

NOTE: The preferred drag angle is 15°, however, NR-152 is capable of welding at zero drag angle, facilitating easy fixturing in automatic applications.

CONFORMANCES

AWS A5: E71T-14

ISO: T49 T14-1 NO S A-G

TYPICAL APPLICATIONS

- Single pass welding on thicknesses from 0.8 mm - 4.8 mm (0.030 in - 3/16 in)
- Spot or short intermittent welds
- Continuous welding on galvanized or zinc coated carbon steel
- Automotive
- Transportation

WARNING

- NR-152 is NOT recommended for welding multiple passes

INNERSHIELD® NR®-203-MP

Mild Steel, All Position · AWS E71T-8-JH8

KEY FEATURES

- Designed to handle poor fit-up on heavy wall tubes and gaps up to 9.5 mm (3/8 in) with 6.4 mm (1/4 in) offset
- Fast freezing slag with excellent wash-in
- Root bead capability without back-up bars

TYPICAL APPLICATIONS

- General plate fabrication, including bridge fabrication, hull plate and stiffener welding on ships and barges
- Storage tanks
- Structural welding
- Offshore welding in TKY joints

CONFORMANCES

- AWS A5:** E71T-8-JH8
- ABS:** 3YSA H15
- CWB/CSA:** E491T8-A4-CS3-H8 (E491T-8-JH8)
- DNV:** III YMS H10
- Lloyd's Register:** 3YS H15
- BV:** SA3YMH
- ISO:** T49 4 T8-1 NO A H10,
T 42 4 Y NO 2 H10 T38 4 Y NO 2 H10

WELDING POSITIONS

All

DIAMETERS / PACKAGING

Diameter in (mm)	14 lb (6.4 kg) Coil 56 lb (25.4 kg) Master Carton	25 lb (11.3 kg) Steel Spool
0.068 [1.7] 5/64 [2.0]	ED021604	ED030640

MECHANICAL PROPERTIES⁽¹⁾

	Yield Strength ⁽²⁾ MPa (ksi)	Tensile Strength MPa (ksi)	Elongation %	Hardness Rockwell B	Charpy V-Notch J (ft-lbf)	
					@ -29°C [-20°F]	@ -40°C [-40°F]
Requirements - AWS E71T-8-J	400 [58] min	480-655 [70-95]	22 min	—	Not Specified	27 [20] min
Typical Results⁽³⁾	415-440 [60-64]	510-545 [74-79]	29-33	82-87	75-203 [55-150]	68-224 [50-165]

DEPOSIT COMPOSITION⁽¹⁾

	%C	%Mn	%Si	%S	%P	%Al
Requirements - AWS E71T-8-J	0.30 max	1.75 max	0.60 max	0.03 max	0.03 max	1.8 max
Typical Results⁽³⁾	0.04-0.07	1.35-1.47	0.22-0.32	≤0.01	≤0.01	0.8-1.0

TYPICAL OPERATING PROCEDURES

Diameter, Polarity	CTWD mm (in)	Wire Feed Speed m/min (in/min)	Voltage (volts)	Approx. Current (amps)	Melt-Off Rate kg/hr (lb/hr)	Deposition Rate kg/hr (lb/hr)	Efficiency (%)
0.068 in (1.7 mm), DC-	25 [1]	1.8 [70]	16-17	145	1.5 [3.3]	1.0 [2.3]	69
		2.3 [90]	18-19	180	1.9 [4.2]	1.5 [3.2]	76
		3.0 [120]	20-21	225	2.5 [5.6]	2.0 [4.3]	76
		3.5 [140]	21-22	255	2.9 [6.4]	2.2 [4.8]	75
		3.8 [150]	23-24	265	3.1 [6.8]	2.3 [5.1]	75
5/64 in (2.0 mm), DC-	25 [1]	1.3 [50]	16-17	130	1.4 [3.1]	0.9 [1.9]	61
		1.8 [70]	18-19	180	2.0 [4.3]	1.3 [2.9]	67
		2.3 [90]	19-20	220	2.5 [5.6]	1.9 [4.2]	75
		2.8 [110]	20-21	260	3.1 [6.8]	2.4 [5.3]	77
		3.0 [120]	21-22	280	3.4 [7.4]	2.7 [5.9]	79
3.5 [140]	22-23	310	3.9 [8.7]	3.1 [6.8]	79		

⁽¹⁾Typical all weld metal. ⁽²⁾Measured with 0.2% offset. ⁽³⁾See test results disclaimer

INNERSHIELD® NR® -211-MP

Mild Steel, All Position · AWS E71T-11

KEY FEATURES

- Versatile welding capability on a variety of base materials
- High operator appeal and good bead appearance
- Easy slag removal
- Fast freezing characteristics accommodate poor fit-up

WELDING POSITIONS

All, except 3/32 in [2.4 mm] diameter

MAXIMUM PLATE THICKNESS

Diameter - in (mm)	Maximum Plate Thickness - in (mm)
0.030 (0.8)	5/16 (7.9)
0.035 (0.9)	5/16 (7.9)
0.045 (1.1)	5/16 (7.9)
0.068 (1.7)	1/2 (12.7)
5/64 (2.0)	1/2 (12.7)
3/32 (2.4)	1/2 (12.7)

CONFORMANCES

AWS A5:	E71T-11
ABS:	E71T-11
CWB/CSA:	0.9 MM-2.4 MM
ISO:	T49 Z T11-1 NO A H15, T 42 Z Z N 1 H10
JIS:	T49 TG-1 N S

TYPICAL APPLICATIONS

- Sheet or thin gauge metal
- Galvanized sheet metal
- Robotic / hard automation
- General fabrication
- 5/16 in. maximum plate thickness for 0.045 in. and smaller diameters
- 1/2 in. maximum plate thickness for 0.068 - 3/32 in. diameters

DIAMETERS / PACKAGING

Diameter in (mm)	1 lb (0.5 kg) Plastic Spool 5 lb (2.3 kg) Master Carton	10 lb (4.5 kg) Plastic Spool	14 lb (6.4 kg) Coil 56 lb (25.4 kg) Master Carton
0.030 (0.8)	ED031448	ED033130	
0.035 (0.9)	ED030584	ED016354	
0.045 (1.1)		ED016363	
0.068 (1.7)			ED012506
5/64 (2.0)			ED012508
3/32 (2.4)			
Diameter in (mm)	25 lb (11.3 kg) Steel Spool	50 lb (22.7 kg) Coil	500 lb (227 kg) Accu-Trak® Drum
0.030 (0.8)			
0.035 (0.9)	ED030637		ED029838
0.045 (1.1)	ED030638		ED029028
0.068 (1.7)	ED030641	ED012507	
5/64 (2.0)	ED030645	ED012509	
3/32 (2.4)		ED013869	

MECHANICAL PROPERTIES⁽¹⁾

	Yield Strength ⁽²⁾ MPa (ksi)	Tensile Strength MPa (ksi)	Elongation %	Hardness Rockwell B
Requirements - AWS E71T-11	400 (58) min	480-655 (70-95)	20 min	—
Typical Results ⁽³⁾	435-475 (63-69)	605-645 (88-94)	22-25	89-92

DEPOSIT COMPOSITION⁽¹⁾

	%C	%Mn	%Si	%S	%P	%Al
Requirements - AWS E71T-11	0.30 max	1.75 max	0.60 max	0.03 max	0.03 max	1.8 max
Typical Results ⁽³⁾	0.23-0.26	0.57-0.66	0.17-0.26	≤0.01	≤0.01	1.3-1.6

TYPICAL OPERATING PROCEDURES

Diameter, Polarity	CTWD mm (in)	Wire Feed Speed m/min (in/min)	Voltage (volts)	Approx. Current (amps)	Melt-Off Rate kg/hr (lb/hr)	Deposition Rate kg/hr (lb/hr)	Efficiency (%)
0.030 in (0.8 mm), DC-	13 (1/2)	1.3 (50)	13-14	30	0.2 (0.5)	0.2 (0.4)	81
		2.5 (100)	13-14	60	0.5 (1.1)	0.4 (0.8)	75
		3.8 (150)	14-15	80	0.7 (1.6)	0.6 (1.2)	78
		5.1 (200)	14-15	100	1.0 (2.1)	0.8 (1.7)	81
		6.4 (250)	15-16	130	1.2 (2.6)	1.0 (2.1)	80
		7.6 (300)	18-19	140	1.4 (3.2)	1.2 (2.6)	81
0.035 in (0.9 mm), DC-	13-16 (1/2-5/8)	1.3 (50)	14-15	30	0.4 (0.8)	0.3 (0.7)	81
		1.8 (70)	15-16	60	0.5 (1.2)	0.5 (1.0)	83
		2.8 (110)	16-17	115	0.7 (1.6)	0.6 (1.3)	78
		3.8 (150)	17-18	130	1.0 (2.2)	0.8 (1.7)	78
		5.1 (200)	18-19	155	1.4 (3.0)	1.1 (2.5)	84
		7.0 (275)	20-21	155	2.0 (4.4)	1.5 (3.4)	78
0.045 in (1.1 mm), DC-	16 (5/8)	1.8 (70)	15-16	120	0.7 (1.6)	0.5 (1.1)	69
		2.3 (90)	16-17	140	1.0 (2.2)	0.8 (1.7)	77
		2.8 (110)	17-18	160	1.2 (2.7)	1.0 (2.3)	85
		3.3 (130)	18-19	170	1.5 (3.2)	1.2 (2.7)	84
0.068 in (1.7 mm), DC-	19-32 (3/4-1 1/4)	1.0 (40)	15-16	125	1.0 (2.1)	0.8 (1.7)	81
		1.9 (75)	18-19	190	1.8 (4.0)	1.5 (3.4)	85
		3.3 (130)	20-21	270	3.2 (7.0)	2.8 (6.1)	88
		4.4 (175)	23-24	300	4.3 (9.4)	3.8 (8.4)	89
5/64 in (2.0 mm), DC-	19-32 (3/4-1 1/4)	1.3 (50)	16-17	180	1.6 (3.5)	1.3 (2.9)	83
		1.9 (75)	18-19	235	2.4 (5.3)	2.0 (4.5)	85
		3.0 (120)	20-21	290	3.8 (8.4)	3.4 (7.4)	88
		4.1 (160)	22-23	325	5.1 (11.2)	4.5 (10.0)	89
3/32 in (2.4 mm), DC-	19-32 (3/4-1 1/4)	1.3 (50)	16-17	245	2.3 (5.0)	1.9 (4.2)	84
		1.9 (75)	19-20	305	3.4 (7.5)	2.9 (6.4)	85
		2.5 (100)	20-21	365	4.5 (10.0)	3.9 (8.7)	87
		3.3 (130)	22-23	400	5.9 (12.9)	5.1 (11.3)	88

⁽¹⁾Typical all weld metal. ⁽²⁾Measured with 0.2% offset. ⁽³⁾See test results disclaimer

INNERSHIELD® NR®-232

Mild Steel, All Position · AWS E71T-8

KEY FEATURES

- High deposition rates for out-of-position welding
- Penetrating arc
- Fast freezing, easy to remove slag system
- Meets AWS D1.8 seismic lot waiver requirements

WELDING POSITIONS

All

TYPICAL APPLICATIONS

- Structural fabrication, including those subject to seismic requirements
- General plate fabrication
- Hull plate and stiffener welding on ships and barges
- Machinery parts, tanks, hoppers, racks and scaffolding

CONFORMANCES

AWS A5:	E71T-8-H16
ABS:	3YSA
CWB/CSA:	E491T-8-H16
DNV:	III YMS H15
Lloyd's Register:	3YS H15
BV:	SA3YMH
AWS D1.8:	0.068", 0.072", 5/64"
ISO:	T55 3 T8-1 NO A H15, T 42 3 Y N 2 H15
JIS:	T49 3 T7-1 N A

DIAMETERS / PACKAGING

Diameter in (mm)	13.5 lb (6.1 kg) Coil 54 lb (24.5 kg) Master Carton	13.5 lb (6.1 kg) Coil 54 lb (24.5 kg) Hermetically Sealed Pail	25 lb (11.3 kg) Steel Spool
0.068 (1.7)	ED012518	ED030232	ED030643
0.072 (1.8)	ED012522		ED030644
5/64 (2.0)	ED012525		ED030647
Diameter in (mm)	25 lb (11.3 kg) Plastic Spool (Vacuum Sealed Foil Bag)		50 lb (22.7 kg) Coil
0.068 (1.7)	ED030949		ED012519
0.072 (1.8)			ED012523
5/64 (2.0)			ED012526

MECHANICAL PROPERTIES⁽¹⁾

	Yield Strength ⁽²⁾ MPa (ksi)	Tensile Strength MPa (ksi)	Elongation %	Hardness Rockwell B	Charpy V-Notch / J ft-lbf @ -29°C [-20°F]
Requirements - AWS E71T-8	400 (58) min	480-655 (70-95)	22 min	–	27 (20) min
Typical Results⁽³⁾ - As-Welded	460-520 (66-75)	575-615 (83-89)	25-31	87-90	47-75 (35-55)

DEPOSIT COMPOSITION⁽¹⁾

	%C	%Mn	%Si	%S	%P	%Al
Requirements - AWS E71T-8	0.30 max	1.75 max	0.60 max	0.03 max	0.03 max	1.8 max
Typical Results⁽³⁾	0.16-0.18	0.61-0.72	0.26-0.33	≤0.01	≤0.01	0.5-0.8

TYPICAL OPERATING PROCEDURES

Diameter, Polarity	CTWD ⁽⁴⁾ mm (in)	Wire Feed Speed m/min (in/min)	Voltage ⁽⁵⁾ (volts)	Approx. Current (amps)	Melt-Off Rate kg/hr (lb/hr)	Deposition Rate kg/hr (lb/hr)	Efficiency (%)
0.068 in (1.7 mm), DC-	19-32 (3/4-1 1/4)	2.8 (110)	18-19	195	2.3 (5.0)	1.8 (3.9)	78
		3.3 (130)	19-21	225	2.8 (6.2)	2.0 (4.6)	74
		3.8 (150)	19-21	250	3.2 (7.1)	2.4 (5.3)	75
		4.3 (170)	20-22	270	3.5 (7.8)	2.8 (6.1)	78
		5.0 (195)	23-24	300	4.3 (9.4)	3.2 (7.0)	74
		6.4 (250)	23-24	350	5.4 (11.8)	4.0 (9.0)	76
		7.4 (320)	25-27	400	6.9 (15.2)	5.2 (11.4)	75
0.072 in (1.8 mm), DC-	19-32 (3/4-1 1/4)	2.0 (80)	16-18	130	1.8 (4.0)	1.5 (3.3)	83
		3.5 (140)	18-21	225	3.1 (6.8)	2.5 (5.5)	81
		3.9 (155)	19-22	240	3.3 (7.2)	2.7 (6.0)	83
		4.3 (170)	20-23	255	3.6 (8.0)	2.9 (6.5)	81
		6.4 (250)	22-24	315	5.3 (11.7)	4.3 (9.6)	82
		7.4 (290)	23-25	350	6.2 (13.6)	5.0 (11.0)	81
5/64 in (2.0 mm), DC-	19-32 (3/4-1 1/4)	1.5 (60)	16-17	145	1.7 (3.7)	1.2 (2.7)	73
		2.9 (115)	19-20	260	3.2 (7.0)	2.5 (5.5)	78
		3.0 (120)	19-20	270	3.3 (7.3)	2.6 (5.7)	78
		3.3 (130)	20-21	285	3.5 (7.8)	2.8 (6.2)	79
		4.6 (180)	22-23	365	5.0 (10.9)	3.9 (8.7)	80

⁽¹⁾Typical all weld metal. ⁽²⁾Measured with 0.2% offset. ⁽³⁾See test results disclaimer
NOTE: FEMA 353 and AWS D1.8 structural steel seismic supplement test data can be found on this product at www.lincolnelectric.com.

INNERSHIELD® NR® -232-H

Mild Steel, All Position · AWS E71T-8-H8

KEY FEATURES

- High deposition rates for out-of-position welding
- Penetrating arc
- Fast freezing, easy to remove slag system

CONFORMANCES

AWS A5:	E71T-8-H8
CWB/CSA:	E491T-8-H8
AWS D1.8:	0.068", 0.072"

WELDING POSITIONS

All

TYPICAL APPLICATIONS

- Structural fabrication, including those subject to seismic requirements
- General plate fabrication
- Machinery parts, tanks, hoppers, racks and scaffolding

DIAMETERS / PACKAGING

Diameter in (mm)	25 lb (11.3 kg) Plastic Spool (Vacuum Sealed Foil Bag)
0.068 (1.7)	ED036677
0.072 (1.8)	ED036678

MECHANICAL PROPERTIES⁽¹⁾

	Yield Strength ⁽²⁾ MPa (ksi)	Tensile Strength MPa (ksi)	Elongation %	Hardness Rockwell B	Charpy V-Notch / J (ft-lbf) @ -29°C [-20°F]
Requirements - AWS E71T-8-H8	400 (58) min	480-655 (70-95)	22 min	–	27 (20) min
Typical Results⁽³⁾ - As-Welded	460-520 (66-75)	575-615 (83-89)	25-31	87-90	47-75 (35-55)

⁽¹⁾Typical all weld metal. ⁽²⁾Measured with 0.2% offset. ⁽³⁾See test results disclaimer

DEPOSIT COMPOSITION⁽¹⁾

	%C	%Mn	%Si	%S	%P	%Al	Diffusible Hydrogen (mL/100g weld deposit)
Requirements - AWS E71T-8-H8	0.30 max	1.75 max	0.60 max	0.03 max	0.03 max	1.8 max	8.0 max
Typical Results⁽²⁾	0.16-0.18	0.61-0.72	0.26-0.33	≤0.01	≤0.01	0.5-0.8	5-7

TYPICAL OPERATING PROCEDURES

Diameter, Polarity	CTWD ⁽³⁾ mm [in]	Wire Feed Speed m/min [in/min]	Voltage ⁽⁴⁾ [volts]	Approx. Current [amps]	Melt-Off Rate kg/hr [lb/hr]	Deposition Rate kg/hr [lb/hr]	Efficiency [%]
0.068 in (1.7 mm), DC-	19-32 (3/4-1 1/4)	2.8 (110)	18-19	195	2.3 (5.0)	1.8 (3.9)	78
		3.3 (130)	19-21	225	2.8 (6.2)	2.0 (4.6)	74
		3.8 (150)	19-21	250	3.2 (7.1)	2.4 (5.3)	75
		4.3 (170)	20-22	270	3.5 (7.8)	2.8 (6.1)	78
		5.0 (195)	23-24	300	4.3 (9.4)	3.2 (7.0)	74
		6.4 (250)	23-24	350	5.4 (11.8)	4.0 (9.0)	76
		7.4 (320)	25-27	400	6.9 (15.2)	5.2 (11.4)	75
0.072 in (1.8 mm), DC-	19-32 (3/4-1 1/4)	2.0 (80)	16-18	130	1.8 (4.0)	1.5 (3.3)	83
		3.5 (140)	18-21	225	3.1 (6.8)	2.5 (5.5)	81
		3.9 (155)	19-22	240	3.3 (7.2)	2.7 (6.0)	83
		4.3 (170)	20-23	255	3.6 (8.0)	2.9 (6.5)	81
		6.4 (250)	22-24	315	5.3 (11.7)	4.3 (9.6)	82
		7.4 (290)	23-25	350	6.2 (13.6)	5.0 (11.0)	81

⁽¹⁾Typical all weld metal. ⁽²⁾Measured with 0.2% offset. ⁽³⁾See test results disclaimer
NOTE: AWS D1.8 structural steel seismic supplement test data can be found on this product at www.lincolnelectric.com.

INNERSHIELD® NR®-233

Mild Steel, All Position · AWS E71T-8-H8



KEY FEATURES

- High deposition rates for out-of-position welding
- Welder-friendly, easy to use and great bead appearance
- Minimal gas marking
- Meets AWS D1.8 seismic lot waiver requirements

CONFORMANCES

- AWS A5:** E71T-8-H8
- ABS:** 3YSA, E71T-8-H16
- AWS D1.8:** 0.072", 1/16", 5/64"
- ISO:** T49 3 T8-1 NO A-U H10
- JIS:** Z 3313: T49 3 T7-1 N A

WELDING POSITIONS

All

NOTES

- Innershield® K126 Gun Assembly requires one of the following gun tube assemblies for better wire feeding - KP2454-1 (62°, 7.5 in), KP2455-1 (45°, 6 in), KP2456-1 (30°, 12 in)

TYPICAL APPLICATIONS

- Structural fabrication, including those subject to seismic requirements
- General plate fabrication
- Ship and barge fabrication
- Vertical up and overhead fillets and groove welds

DIAMETERS / PACKAGING

Diameter in (mm)	12.5 lb (5.7 kg) Plastic Spool 50 lb (22.7 kg) Master Carton	25 lb (11.3 kg) Plastic Spool	25 lb (11.3 kg) Plastic Spool (Vacuum Sealed Foil Bag)
1/16 (1.6)	ED030933	ED030934	ED031576, ED036576*
0.072 (1.8)		ED031030	
5/64 (2.0)		ED033039	ED033024, ED036577*

*Buy America Product

MECHANICAL PROPERTIES⁽¹⁾

	Yield Strength ⁽²⁾ MPa (ksi)	Tensile Strength MPa (ksi)	Elongation %	Hardness Rockwell B	Charpy V-Notch J (ft-lbf) @ -29°C (-20°F)
Requirements - AWS E71T-8-H8	400 (58) min	480-655 (70-95)	22 min	—	27 (20) min
Typical Results⁽³⁾ - As-Welded	435-455 (63-66)	575-595 (83-86)	26-29	87-89	34-54 (25-40)

⁽¹⁾Typical all weld metal. ⁽²⁾Measured with 0.2% offset. ⁽³⁾See test results disclaimer.

DEPOSIT COMPOSITION⁽¹⁾

	%C	%Mn	%Si	%S	%P	%Al
Requirements - AWS E71T-8-H8	0.30 max	1.75 max	0.60 max	0.03 max	0.03 max	1.8 max
Typical Results⁽²⁾	0.15-0.20	0.61-0.65	0.17-0.21	≤0.03	≤0.01	0.5-0.6

TYPICAL OPERATING PROCEDURES

Diameter, Polarity	CTWD ⁽³⁾ mm (in)	Wire Feed Speed m/min (in/min)	Voltage (volts)	Approx. Current (amps)	Melt-Off Rate kg/hr (lb/hr)	Deposition Rate kg/hr (lb/hr)	Efficiency (%)
1/16 in (1.6 mm), DC-	25 (1)	3.8 (150)	17-19	220	2.4 (5.3)	1.9 (4.2)	80
		5.1 (200)	19-21	245	3.2 (7.1)	2.5 (5.4)	76
		6.4 (250)	21-23	270	4.0 (8.9)	3.0 (6.6)	74
		7.6 (300)	23-25	295	4.7 (10.4)	3.5 (7.7)	75
		8.9 (350)	25-27	315	5.6 (12.3)	4.3 (9.4)	77
0.072 in (1.8 mm), DC-	19-25 (3/4-1) ⁽⁴⁾	2.5 (100)	17-18	184	2.0 (4.5)	1.6 (3.6)	80
		3.8 (150)	18-19	250	3.1 (6.7)	2.5 (5.4)	80
		5.1 (200)	20-21	295	4.0 (8.9)	3.2 (7.1)	81
		6.4 (250)	22-23	330	5.1 (11.2)	4.0 (8.9)	79
		7.6 (300)	23-24	355	6.1 (13.4)	4.8 (10.6)	79
5/64 in (2.0 mm), DC-	19-25 (3/4-1) ⁽⁴⁾	2.3 (90)	18-19	210	2.2 (4.9)	1.8 (4.1)	82
		3.2 (125)	19-20	260	3.2 (7.0)	2.6 (5.6)	81
		3.8 (150)	20-21	300	3.8 (8.4)	3.0 (6.7)	80
		5.1 (200)	21-22	340	5.1 (11.2)	4.1 (9.0)	81
		6.1 (240)	22-23	380	6.1 (13.3)	4.9 (10.8)	81

⁽¹⁾Typical all weld metal. ⁽²⁾Measured with 0.2% offset. ⁽³⁾See test results disclaimer ⁽⁴⁾CTWD for 0.072 in. (1.8 mm) and 5/64 in. (2.0 mm) for 200 ipm or greater is 1 in (25 mm).
NOTE: For horizontal welding, subtract 1 volt. NOTE: FEMA and AWS D1.8 structural steel seismic supplement test data can be found on this product at www.lincolnelectric.com/d1.8.

INNERSHIELD® NR® -203 NICKEL (1%)

Low Alloy, All Position · AWS E71T8-Ni1

KEY FEATURES

- Designed to produce a nickel bearing weld deposit
- Capable of producing weld deposits with impact toughness capable of exceeding 27 J (20 ft-lbf) at -29°C (-20°F)
- Color match on weathering steels
- Handles poor fit-up
- Root bead capability

TYPICAL APPLICATIONS

- Roundabout groove welds on heavy wall tubular construction
- Offshore
- Structural fabrication
- Bridges and other structural components made from weathering steels
- NACE applications

CONFORMANCES

AWS A5:	E71T8-Ni1-H16
ABS:	3YSA
CWB/CSA:	E491T8-A3-Ni1-H16, E491T8-Ni1-H16
DNV:	III YMS H10
Lloyd's Register:	3YS H15
ISO:	T49 4 T8-1 NO A-N2 H15, T 42 3 1Ni Y N 1 H10

WELDING POSITIONS

All

DIAMETERS / PACKAGING

Diameter in (mm)	14 lb (6.4 kg) Coil 56 lb (25.4 kg) Master Carton	50 lb (22.7 kg) Coil
5/64 (2.0)	ED012385	ED012386

MECHANICAL PROPERTIES⁽¹⁾

	Yield Strength ⁽²⁾ MPa (ksi)	Tensile Strength MPa (ksi)	Elongation %	Hardness Rockwell B	Charpy V-Notch J (ft-lbf) @ -29°C (-20°F)
Requirements - AWS E71T8-Ni1	400 [58] min	480-620 [70-90]	20 min	—	27 [20] min
Typical Results⁽³⁾ - As-Welded	450-480 [65-70]	545-575 [79-83]	27-32	86-90	81-156 [60-115]

DEPOSIT COMPOSITION⁽¹⁾

	%C	%Mn	%Si	%S	%P
Requirements - AWS E71T8-Ni1	0.12 max	1.50 max	0.80 max	0.030 max	0.030 max
Typical Results⁽³⁾	0.05-0.07	1.10-1.22	0.30-0.33	≤0.010	0.005-0.008
	%Ni	%Cr	%Mo	%V	%Al
Requirements - AWS E71T8-Ni1	0.80-1.10	0.15 max	0.35 max	0.05 max	1.8 min
Typical Results⁽³⁾	0.89-1.05	0.02-0.03	0.01-0.02	≤0.01	0.8-1.0

TYPICAL OPERATING PROCEDURES

Diameter, Polarity	CTWD mm (in)	Wire Feed Speed m/min (in/min)	Voltage (volts)	Approx. Current (amps)	Melt-Off Rate kg/hr (lb/hr)	Deposition Rate kg/hr (lb/hr)	Efficiency [%]
5/64 in (2.0 mm), DC-	25 [1]	1.3 [50]	16-17	145	1.4 [3.0]	1.0 [2.3]	76
		1.8 [70]	18-19	195	2.0 [4.3]	1.5 [3.3]	76
		2.3 [90]	19-20	240	2.5 [5.5]	2.0 [4.3]	78
		2.8 [110]	20-21	275	3.0 [6.7]	2.4 [5.3]	79
		3.0 [120]	21-22	290	3.3 [7.3]	2.6 [5.8]	79
		3.5 [140]	22-23	310	3.9 [8.5]	3.0 [6.9]	81

⁽¹⁾Typical all weld metal. ⁽²⁾Measured with 0.2% offset. ⁽³⁾See test results disclaimer

INNERSHIELD® NR®-207

Low Alloy, All Position · AWS E71T8-K6

KEY FEATURES

- Vertical down hot, fill and cap passes on standard cross-country pipelines and arcticgrade pipe
- Recommended for API grades X42 up to undermatching X70
- High deposition rates

TYPICAL APPLICATIONS

- Standard cross-country pipelines
- Arctic grade pipe up to undermatched X70

DIAMETERS / PACKAGING

Diameter in (mm)	14 lb (6.4 kg) Coil	
	56 lb (25.4 kg) Hermetically Sealed Pail	
0.068 (1.7)	ED016312	
5/64 (2.0)	ED012438	

MECHANICAL PROPERTIES⁽¹⁾

	Yield Strength ⁽²⁾ MPa (ksi)	Tensile Strength MPa (ksi)	Elongation %	Hardness Rockwell B	Charpy V-Notch J (ft-lbf) @ -29°C [-20°F]
Requirements ⁽⁴⁾ - AWS E71T8-K6	400 (58) min	480-620 (70-90)	20 min	–	27 (20) min
Typical Results ⁽³⁾	415-445 (60-64)	520-545 (75-79)	29-33	84-87	81-237 (60-175)

DEPOSIT COMPOSITION⁽¹⁾

	%C	%Mn	%Si	%S	%P
Requirements - AWS E71T8-K6	0.15 max	0.50-1.50	0.80 max	0.030 max	0.030 max
Typical Results ⁽³⁾	0.05-0.07	0.87-0.96	0.23-0.27	≤0.003	0.004-0.008
	%Ni	%Cr	%Mo	%V	%Al
Requirements - AWS E71T8-K6	0.40-1.00	0.20 max	0.15 max	0.05 max	1.8 max
Typical Results ⁽³⁾	0.73-0.83	0.02-0.03	0.02-0.03	≤0.01	0.9-1.1

TYPICAL OPERATING PROCEDURES

Diameter, Polarity	CTWD mm (in)	Wire Feed Speed m/min (in/min)	Voltage (volts)	Approx. Current (amps)	Melt-Off Rate kg/hr (lb/hr)	Deposition Rate kg/hr (lb/hr)	Efficiency (%)
0.068 in (1.7 mm), DC-	25 (1)	2.0 (80)	17-18	190	1.7 (3.8)	1.3 (3.0)	79
		2.6 (105)	18-19	230	2.2 (5.3)	1.8 (4.0)	80
		3.0 (120)	19-20	245	2.5 (5.7)	2.0 (4.5)	79
		3.5 (140)	21-22	275	3.0 (6.8)	2.4 (5.5)	81
		4.4 (175)	21-22	295	3.6 (8.0)	2.9 (6.4)	80
5/64 in (2.0 mm), DC-	25 (1)	1.7 (70)	17-18	205	2.0 (4.5)	1.5 (3.4)	76
		2.0 (80)	18-19	225	2.3 (5.1)	1.7 (3.9)	76
		2.2 (90)	18-19	240	2.6 (5.8)	2.0 (4.5)	78
		2.7 (110)	20-21	275	3.1 (7.0)	2.4 (5.5)	79
		3.3 (130)	20-21	300	3.7 (8.3)	2.9 (6.5)	78

⁽¹⁾Typical all weld metal. ⁽²⁾Measured with 0.2% offset. ⁽³⁾See test results disclaimer

CONFORMANCES

AWS A5:	E71T8-K6, E71T8-K6-H16
CWB/CSA:	E491T8-A3-K6-H16, E491T8-K6-H16
DNV:	III YMS H15
BV:	SA3YMH
ISO:	T49 3 T8-1 NO A-N1 H15 for 5/64" only

WELDING POSITIONS

All

INNERSHIELD® NR®-208-H

Low Alloy, All Position · AWS E91T8-G-H8

KEY FEATURES

- Designed to create high strength weld deposits
- Recommended for API grade X80
- High deposition rates

TYPICAL APPLICATIONS

- Standard cross-country pipelines
- Undermatched X80 grade pipe

CONFORMANCES

AWS A5: E91T8-G-H8

WELDING POSITIONS

All, except vertical up

DIAMETERS / PACKAGING

Diameter in (mm)	14 lb (6.4 kg) Coil 56 lb (25.4 kg) Hermetically Sealed Pail
5/64 (2.0)	ED023366

MECHANICAL PROPERTIES⁽¹⁾

	Yield Strength ⁽²⁾ MPa (ksi)	Tensile Strength MPa (ksi)	Elongation %	Hardness Rockwell B	Charpy V-Notch J (ft-lbf) @ -29°C (-20°F)
Requirements - AWS E91T8-G-H8	540 (78) min	620-760 (90-110)	17 min	–	Not Specified
Typical Results⁽³⁾ - As-Welded	555-600 (81-87)	630-670 (91-97)	24-27	91-95	54-129 (40-95)

DEPOSIT COMPOSITION⁽¹⁾

	%C	%Mn	%Si	%S	%P	%Ni ⁽⁴⁾
Requirements - AWS E91T8-G-H8	Not Specified	0.50 min	1.00 max	0.030 max	0.030 max	0.50 min
Typical Results⁽³⁾	0.04-0.07	1.48-2.02	0.11-0.31	≤0.003	0.004-0.010	0.71-0.98
	%Cr ⁽⁴⁾	%Mo ⁽⁴⁾	%V ⁽⁴⁾	%Al ⁽⁴⁾	Diffusible Hydrogen (mL/100g weld metal)	
Requirements - AWS E91T8-G-H8	0.30 min	0.20 max	0.10 min	1.8 min	8.0 max	
Typical Results⁽³⁾	0.02-0.03	≤0.04	≤0.01	0.9-1.2	≤8	

TYPICAL OPERATING PROCEDURES

Diameter, Polarity	CTWD mm (in)	Wire Feed Speed m/min (in/min)	Voltage (volts)	Approx. Current (amps)	Melt-Off Rate kg/hr (lb/hr)	Deposition Rate kg/hr (lb/hr)	Efficiency (%)
5/64 in (2.0 mm), DC-	25 (1)	1.7 (70)	16-17	195	1.8 (4.0)	1.4 (3.2)	81
		2.0 (80)	17-18	220	2.1 (4.6)	1.7 (3.9)	84
		2.2 (90)	18-19	235	2.5 (5.4)	2.0 (4.5)	84
		2.7 (110)	19-20	270	2.9 (6.5)	2.4 (5.5)	85
		3.3 (130)	19-20	295	3.5 (7.6)	2.9 (6.5)	85

⁽¹⁾Typical all weld metal. ⁽²⁾Measured with 0.2% offset. ⁽³⁾See test results disclaimer ⁽⁴⁾In order to meet the alloy requirements of the G group, the weld deposit needs to have the minimum, as specified in the table, of only one of the elements marked.

INNERSHIELD® NR® -212

Low Alloy, All Position · AWS E71TG-G

KEY FEATURES

- Accommodates a wide range of mild steels
- Fast freeze characteristics accommodate poor fit-up
- Smooth arc performance and ease of use

WELDING POSITIONS

All

MAXIMUM PLATE THICKNESS

Diameter - in (mm)	Maximum Plate Thickness - in (mm)
0.045 (1.1)	3/4 (19.1)
0.068 (1.7)	3/4 (19.1)
5/64 (2.0)	3/4 (19.1)

CONFORMANCES

AWS A5: E71TG-G-H16

CWB/CSA: E491TG-G-H16

ISO: T49 Z T11-1 NO A-G H15

TYPICAL APPLICATIONS

- Single or multiple pass welding on up to 19 mm (3/4 in) thicknesses
- General fabrication
- Robotics
- Truck bodies, tanks, hoppers, racks and scaffolding
- Welding on galvanized steel or zinc coated carbon steel

DIAMETERS / PACKAGING

Diameter in (mm)	10 lb (4.5 kg) Plastic Spool	14 lb (6.4 kg) Coil 56 lb (25.4 kg) Master Carton	25 lb (11.3 kg) Steel Spool	50 lb (22.7 kg) Coil
0.045 (1.1)	ED026090		ED030639	
0.068 (1.7)		ED027803	ED030642	
5/64 (2.0)		ED027794	ED030646	ED026858

MECHANICAL PROPERTIES⁽¹⁾

	Yield Strength ⁽²⁾ MPa (ksi)	Tensile Strength MPa (ksi)	Elongation %	Hardness Rockwell B
Requirements - AWS E71TG-G	400 (58) min	480-655 (70-95)	20 min	—
Typical Results ⁽³⁾	440-505 (64-74)	575-605 (84-88)	24-28	89-92

DEPOSIT COMPOSITION^(b)

	%C	%Mn ^(d)	%Si	%S	%P
Requirements - AWS E71TG-G	Not Specified	0.50 min	1.00 max	0.030 max	0.030 max
Typical Results^(b)	0.06-0.11	0.84-1.55	0.20-0.33	≤0.003	0.006-0.009
	%Ni ^(d)	%Cr ^(d)	%Mo ^(d)	%V ^(d)	%Al
Requirements - AWS E71TG-G	0.50 min	0.30 min	0.20 min	0.10 min	1.8 max
Typical Results^(b)	1.02-1.15	0.02-0.04	≤0.02	—	1.3-1.6

TYPICAL OPERATING PROCEDURES

Diameter, Polarity	CTWD mm (in)	Wire Feed Speed m/min (in/min)	Voltage (volts)	Approx. Current (amps)	Melt-Off Rate kg/hr (lb/hr)	Deposition Rate kg/hr (lb/hr)	Efficiency (%)
0.045 in (1.1 mm), DC-	16 (5/8)	1.4 (55)	14-15	75	0.5 (1.3)	0.5 (1.1)	84
		1.8 (70)	15-16	90	0.7 (1.6)	0.6 (1.4)	87
		2.3 (90)	16-17	115	1.0 (2.1)	0.8 (1.8)	85
		2.8 (110)	17-18	135	1.2 (2.6)	1.0 (2.2)	84
		3.3 (130)	18-19	155	1.4 (3.1)	1.2 (2.6)	83
		4.1 (160)	19-20	170	1.6 (3.5)	1.4 (3.0)	85
0.068 in (1.7 mm), DC-	25 (1)	1.5 (60)	16-17	145	1.4 (3.1)	1.1 (2.4)	77
		1.9 (75)	17-18	180	1.7 (3.8)	1.4 (3.2)	84
		2.3 (90)	18-19	200	2.0 (4.5)	1.7 (3.8)	84
		3.0 (120)	19-20	230	2.7 (6.0)	2.3 (5.2)	86
		3.8 (150)	20-21	255	3.3 (7.4)	2.9 (6.4)	86
		4.4 (175)	22-23	275	3.9 (8.7)	3.4 (7.5)	86
5/64 in (2.0 mm), DC-	25 (1)	1.5 (60)	16-17	200	1.7 (3.8)	1.5 (3.3)	86
		1.9 (75)	18-19	225	2.1 (4.7)	1.8 (4.1)	87
		2.3 (90)	19-20	245	2.6 (5.7)	2.3 (5.0)	87
		2.8 (110)	20-21	275	3.2 (7.1)	2.8 (6.2)	87
		3.3 (130)	21-23	300	3.7 (8.3)	3.3 (7.3)	87
		3.8 (150)	22-23	325	4.3 (9.6)	3.8 (8.4)	87

^(b)Typical all weld metal. ^(c)Measured with 0.2% offset. ^(d)See test results disclaimer ^(e)In order to meet the alloy AWS requirements of the G group, the weld deposit needs to have the minimum, as specified in the table, of only one of these elements.

INNERSHIELD® NR®-440Ni2

Low Alloy, All Position · AWS E71T8-Ni2-JH8

KEY FEATURES

- Designed to provide optimal weldability in narrow TKY joints and poor fit up conditions
- Expect fast travel speeds and a flat bead face when using vertical-up or vertical-down welding techniques
- Low temperature impact toughness, meets ABS 4YSA and AWS J classification
- Meets H8 diffusible hydrogen requirements over a range of humidity levels
- ProTech® hermetically sealed packaging
- Q2 Lot® - Certificate showing actual deposit chemistry and mechanical properties per lot available online.

CONFORMANCES

- AWS A5:** E71T8-Ni2-JH8
ABS: 4YSA H5
DNV: IV YMS H5
Lloyd's Register: 4YS H5
ISO: T49 4 T8-1 NO A-N5 H5

TYPICAL APPLICATIONS

- Offshore

WELDING POSITIONS

All

DIAMETERS / PACKAGING

Diameter in (mm)	8 lb [3.6 kg] Spool 48 lb [21.8 kg] Hermetically Sealed Pail	14 lb [6.4 kg] Coil 56 lb [25.4 kg] Hermetically Sealed Pail
1/16 [1.6]	ED034365	ED034200
5/64 [2.0]	ED034195	ED033827

MECHANICAL PROPERTIES⁽¹⁾

	Yield Strength ⁽²⁾ MPa [ksi]	Tensile Strength MPa [ksi]	Elongation %	Charpy V-Notch J [ft-lbf] @-40°C [-40°F]
Requirements⁽⁴⁾ - AWS E71T8-Ni2-JH8	400 [58] min	480-620 [70-90]	22 min	27 [20] min
Typical Results⁽³⁾	400-485 [58-70]	490-570 [71-83]	22-36	215-460 [160-340]

DEPOSIT COMPOSITION⁽¹⁾

	%C	%Mn	%Ni	%Si	%S	%P	%Al
Requirements AWS E71T8-Ni2-JH8	0.30 max	1.75 max	1.75-2.75	0.60 max	0.030 max	0.030 max	1.8 max
Typical Results^(3,4)	0.01-0.03	0.74-1.12	1.77-2.10	0.13-0.17	0.002-0.004	0.007-0.012	0.84-1.07

TYPICAL OPERATING PROCEDURES

Diameter, Polarity	CTWD mm [in]	Wire Feed Speed m/min [in/min]	Voltage (volts)	Approx. Current (amps)	Melt-Off Rate kg/hr [lb/hr]	Deposition Rate kg/hr [lb/hr]	Efficiency (%)
1.6 mm [1/16 in], DC-	22 [7/8]	2.3 [90]	17-18	160	1.6 [3.6]	1.1 [2.5]	69
		2.5 [100]	18-19	170	1.6 [3.6]	1.2 [2.8]	72
		2.8 [110]	18-19	180	2.0 [4.4]	1.4 [3.1]	73
		3.0 [120]	19-20	195	2.2 [4.8]	1.6 [3.5]	73
		3.3 [130]	19-20	210	2.3 [5.1]	1.7 [3.7]	73
2.0 mm [5/64 in], DC-	25 [1]	1.8 [70]	16-17	205	1.9 [4.2]	1.5 [3.2]	76
		2.0 [80]	17-18	225	2.2 [4.7]	1.6 [3.6]	77
		2.3 [90]	18-19	240	2.4 [5.3]	1.9 [4.2]	78
		2.5 [100]	19-20	260	2.7 [5.9]	2.1 [4.7]	79
		2.8 [110]	20-21	260	3.0 [6.5]	2.4 [5.2]	80
		3.0 [120]	20-21	295	3.2 [7.1]	2.5 [5.6]	79

⁽¹⁾Typical all weld metal. ⁽²⁾Measured with 0.2% offset. ⁽³⁾See test results disclaimer ⁽⁴⁾The strength and elongation properties reported were obtained from a 2.8 mm [0.505 in] tensile specimen artificially aged at 104°C [220°F] for 48 hours, as permitted by AWS A5.20-05. A naturally aged tensile specimen may take months to achieve the specified properties. See AWS A5.20-05, paragraph A8.3. The time required for the natural aging of weld deposits is dependent upon ambient conditions, weldment geometry, the metallurgical structure of the weld deposit and other factors.

INNERSHIELD® NR® -555

Low Alloy, All Position · AWS E81T8-G

KEY FEATURES

- Self-shielded electrode designed for welding in structural applications
- Welder friendly operability and flat bead face in out-of-position fillets and groove welds
- Meets AWS D1.8 seismic lot waiver requirements
- ProTech® foil bag packaging shields against moisture, prevents rust and prolongs storage life

CONFORMANCES

- AWS A5:** E81T8-G
- CWB/CSA:** E551T8-G, E81T8-G for 5/64" only
- AWS D1.8:** 5/64"
- ISO:** T46 5 Z Y NO 1 H10, T55 5 T8-1 NO A-G H10
- JIS Z 3313:** T55 5 T7-1 N A N2M1

WELDING POSITIONS

All

TYPICAL INDUSTRY SEGMENTS

- Structural
- General Fabrication

DIAMETERS / PACKAGING

Diameters in (mm)	25 lb (11.3 kg) Plastic Spool
1/16 (1.6)	ED035565
5/64 (2.0)	ED035566

MECHANICAL PROPERTIES⁽¹⁾

	Yield Strength ⁽²⁾ MPa (ksi)	Tensile Strength MPa (ksi)	Elongation (%)	Charpy V-Notch J (ft-lbf)		
				-46°C (-50°F)	-29°C (-20°F)	21°C (70°F)
Requirements AWS A5.29: E81T8-G	470 (68) min	550-690 (80-100) min	19	-	-	-
AWS A5.36: E81T8-A5-K8-H8		550 (80) min		27 (20) min	-	-
AWS D1.8: 80 ksi Classification				-	54 (40) min	54 (40) min
Typical Results⁽³⁾ AWS A5.36	550 (80)	630 (91)	25	100 (74)	-	-
AWS D1.8 High Heat Input (80 kJ/in)	490 (70)	615 (88)	26	-	64 (47)	143 (105)
AWS D1.8 Low Heat Input (30 kJ/in)	580 (84)	650 (93)	24	-	108 (80)	172 (127)

DEPOSIT COMPOSITION⁽¹⁾

	%C	%Mn	%Si	%S	%P	%Ni
Requirements AWS A5.29: E81T8-G	0.15 max	1.00-2.00	0.40 max	0.030 max	0.030 max	0.50-1.50
AWS A5.36: E81T8-A5-K8-H8						
Typical Results⁽²⁾	0.05	1.84	0.17	0.001	0.011	1.12
	%Cr	%Mo	%V	%Al	Diffusible Hydrogen (mL/100g weld deposit)	
Requirements AWS A5.29: E81T8-G	0.20 max	0.20 max	0.05 max	1.80 max	-	
AWS A5.36: E81T8-A5-K8-H8						
Typical Results⁽³⁾	0.05	0.01	0.00	0.84	5	

TYPICAL OPERATING PROCEDURES

Diameter, Polarity Shielding Gas	CTWD ⁽⁴⁾ mm (in)	Wire Feed Speed m/min (in/min)	Voltage (volts)	Approx. Current (amps)	Melt-Off Rate kg/hr (lb/hr)	Deposition Rate kg/hr (lb/hr)	Efficiency (%)
1/16 in (1.6 mm), DC- Optimal Settings	22 (7/8)	2.8 (110)	19	185	2.0 (4.5)	1.5 (3.4)	77%
	Min - Max	22 (7/8)	1.8-3.0 (75-120)	16-20	145-200	1.4-2.2 (3.0-4.9)	1.0-1.6 (2.2-3.6)
5/64 in (2.0 mm), DC- Optimal Settings	22 (7/8)	2.8 (110)	19	245	2.9 (6.5)	2.5 (5.5)	85%
	Min - Max	22 (7/8)	1.8-3.0 (75-120)	16-21	185-260	1.9-3.2 (4.1-7.1)	1.4-2.6 (3.0-5.8)

⁽¹⁾Typical all weld metal. ⁽²⁾Measure with 0.2% offset. ⁽³⁾See test results disclaimer ⁽⁴⁾To estimate ESO, subtract 1/4 in. (6.0 mm) from CTWD.

ULTRACORE® 360® C71

Mild Steel, All Position · AWS E71T-1C-JH4

KEY FEATURES

- Seamless design protects the flux core from environmental exposure helping to maintain low diffusible hydrogen and extend shelf life
- Copper coating offers superior feedability and extended contact tip life
- Low spatter and fume levels for less post-weld clean up and a better work environment
- Low H4 diffusible hydrogen levels minimize the risk of hydrogen induced cracking
- Premium arc performance and bead appearance

WELDING POSITIONS

All

CONFORMANCES

AWS A5.20: AWS E71T-1C-JH4
AWS D1.8: 0.045", 0.052", 1/16"

TYPICAL APPLICATIONS

- Offshore
- Shipbuilding
- Structural
- General Fabrication

SHIELDING GAS

100% CO₂
 Flow rate: 35 CFH

DIAMETERS / PACKAGING

Diameter in (mm)	27 lb (12.2kg) Steel Spool
0.045 (1.1)	ED036167
0.052 (1.3)	ED036168
1/16 (1.6)	ED036169

MECHANICAL PROPERTIES⁽¹⁾

	Yield Strength ⁽²⁾ MPa (ksi)	Tensile Strength MPa (ksi)	Elongation %	Charpy V-Notch J (ft-lbf)	
				@ -40°C [-40°F]	@ -51°C [-60°F]
Requirements AWS A5.20: E71T1C-JH4	390 (58) min	490-670 (70-95)	22 min	27 (20) min	-
Typical Results⁽³⁾ As-Welded with 100% CO ₂	510-600 (74-87)	590-650 (85-94)	24-29	60-155 (44-114)	62-137 (46-101)

⁽¹⁾Typical all weld metal. ⁽²⁾Measured with 0.2% offset. ⁽³⁾See test results disclaimer

DEPOSIT COMPOSITION⁽¹⁾

	%C	%Mn	%Si	%S	%P	%Ni
Requirements AWS A5.20: E71T-1C-JH4	0.12 max	1.75 max	0.90 max	0.03 max	0.03 max	0.50 max
Typical Results⁽²⁾ As-Welded with 100% CO ₂	0.04-0.08	1.19-1.41	0.37-0.47	0.003-0.005	0.012-0.013	0.35-0.38
	%Cr	%Mo	%V	%Cu	%B	Diffusible Hydrogen (mL/100g weld deposit)
Requirements AWS A5.20: E71T-1C-JH4	0.20 max	0.30 max	0.08 max	0.35 max	—	4.0 max
Typical Results⁽²⁾ As-Welded with 100% CO ₂	0.02-0.03	0.00-0.01	0.01	0.23-0.28	0.003-0.004	1-4

TYPICAL OPERATING PROCEDURES

Diameter, Polarity Shielding Gas	CTWD ⁽³⁾ mm (in)	Wire Feed Speed m/min (in/min)	Voltage [volts]	Approx. Current [amps]	Melt-Off Rate kg/hr (lb/hr)	Deposition Rate kg/hr (lb/hr)	Efficiency [%]
0.045 in (1.1 mm), DC+ 100% CO ₂	25 (1)	6.4 (250)	24-29	175	2.7 (5.9)	2.4 (5.3)	88-93
		7.6 (300)	25-30	200	3.2 (7.0)	2.9 (6.4)	
		8.9 (350)	26-32	225	3.7 (8.2)	3.4 (7.5)	
		10.2 (400)	27-33	245	4.3 (9.4)	3.9 (8.6)	
		11.4 (450)	27-35	265	4.8 (10.6)	4.4 (9.7)	
0.052 in (1.3 mm), DC+ 100% CO ₂	25 (1)	5.1 (200)	23-27	200	2.8 (6.2)	2.6 (5.7)	91-93
		6.4 (250)	25-28	235	3.5 (7.7)	3.2 (7.1)	
		8.9 (350)	27-31	300	4.9 (10.8)	4.5 (10.0)	
		10.8 (425)	28-32	335	6.0 (13.1)	5.5 (12.1)	
1/16 in (1.6 mm), DC+ 100% CO ₂	25 (1)	3.8 (150)	23-27	230	3.1 (6.7)	2.8 (6.1)	92-96
		5.1 (200)	24-28	275	4.1 (9.0)	3.8 (8.4)	
		6.4 (250)	25-31	310	5.1 (11.3)	4.8 (10.6)	
		7.6 (300)	27-34	370	6.1 (13.5)	5.8 (12.8)	
		8.9 (350)	29-36	410	7.2 (15.8)	6.8 (15.0)	

⁽¹⁾Typical all weld metal. ⁽²⁾See test results disclaimer. ⁽³⁾In order to meet the requirements of the G group, the undiluted weld metal shall have not less than the minimum specified for one or more of the elements listed.

⁽⁴⁾To estimate ESO, subtract 1/4 in (6.0 mm) from CTWD. NOTE: This product contains micro-alloying elements. Additional information available upon request

ULTRACORE[®] 360[™] M71

Mild Steel, All Position · AWS E71T-1C-H4, E71T-1M-JH4

KEY FEATURES

- Seamless design protects the flux core from environmental exposure helping to maintain low diffusible hydrogen and extend shelf life
- Copper coating offers superior feedability and extended contact tip life
- Low spatter and fume levels for less post-weld clean up and a better work environment
- Low H4 diffusible hydrogen levels minimize the risk of hydrogen induced cracking
- Premium arc performance and bead appearance

WELDING POSITIONS

All

CONFORMANCES

AWS A5.20: E71T-1C-H4, E71T-1M-JH4
AWS D1.8: 0.045", 0.052", 1/16"

TYPICAL APPLICATIONS

- Offshore
- Shipbuilding
- Structural
- Oil & Gas

SHIELDING GAS

80% Ar / 20% CO₂
 100% CO₂
 Flow rate: 35 CFH

DIAMETERS / PACKAGING

Diameter in (mm)	33 lb (15 kg) Steel Spool
0.045 (1.1)	W000403768
0.052 (1.3)	W000403769
1/16 (1.6)	W000403770

MECHANICAL PROPERTIES⁽¹⁾

	Yield Strength ⁽²⁾ MPa (ksi)	Tensile Strength MPa (ksi)	Elongation %	Charpy V-Notch J (ft·lbf)		
				-18°C (0°F)	-29°C (-20°F)	-40°C (-40°F)
Requirements						
AWS A5.20: E71T-1M-JH4	400 (58) min	490-660 (70-95)	22 min	-	-	27 (20) min
AWS A5.20: E71T-1C-H4				27 (20) min	-	-
Typical Results⁽³⁾						
As-Welded with 80% Ar/ 20% CO ₂	500-540 (72-79)	560-620 (81-90)	24-28	70-100 (51-74)	80-120 (59-90)	35-55 (25-41)
As-Welded with 100% CO ₂	470 (68)	530 (77)	28	60 (44)	-	-

⁽¹⁾Typical all weld metal. ⁽²⁾Measured with 0.2% offset. ⁽³⁾See test results disclaimer

DEPOSIT COMPOSITION⁽¹⁾

	%C	%Mn	%Si	%S
Requirements AWS A5.20: E71T-1M-JH4, E71T-1C-H4	0.12 max	1.75 max	0.90 max	0.03 max
Typical Results⁽²⁾ As-Welded with 80% Ar / 20% CO ₂	0.04-0.06	1.20-1.50	0.40-0.50	< 0.015
	%P	%Cu	%B	Diffusible Hydrogen (mL/100g weld deposit)
Requirements AWS A5.20: E71T-1M-JH4, E71T-1C-H4	0.03 max	0.35 max	Not Specified	4.0 max
Typical Results⁽³⁾ As-Welded with 80% Ar / 20% CO ₂	< 0.015	0.10-0.20	0.003-0.006	1.5-3.5

TYPICAL OPERATING PROCEDURES

Diameter, Polarity Shielding Gas	CTWD ⁽⁴⁾ mm [in]	Wire Feed Speed m/min [in/min]	Voltage [volts]	Approx. Current [amps]	Melt-Off Rate kg/hr [lb/hr]	Deposition Rate kg/hr [lb/hr]	Efficiency [%]
0.045 in (1.1 mm), DC+ 80% Ar / 20% CO ₂	15-20 (3/4)	6.0 [236]	21-23	160	2.5 [5.5]	2.2 [4.8]	85-88
		7.5 [295]	23-24	190	3.1 [6.9]	2.7 [6.0]	
		9.0 [354]	24-26	220	3.8 [8.3]	3.3 [7.3]	
		10.5 [413]	26-28	250	4.4 [9.7]	3.9 [8.6]	
		11.5 [453] [512]	27-29	260	4.8 [10.6]	4.3 [9.4]	
		13.0 [590]	28-30	270	5.4 [12.0]	4.8 [10.7]	
0.052 in (1.3 mm), DC+ 80% Ar / 20% CO ₂	15-20 (3/4)	5.0 [197]	21-22	210	2.7 [6.1]	2.4 [5.3]	85-88
		6.0 [236]	23-24	240	3.3 [7.3]	2.9 [6.3]	
		8.0 [315]	26-27	280	4.4 [9.7]	3.9 [8.5]	
		9.0 [354]	27-29	300	4.9 [10.9]	4.4 [9.7]	
		10.0 [394]	27-29	320	5.5 [12.1]	4.9 [10.8]	
		12.5 [492]	29-30	350	6.9 [15.1]	6.1 [13.5]	
1/16 in (1.6 mm), DC+ 80% Ar / 20% CO ₂	15-20 (3/4)	3.1 [122]	21-22	190	2.4 [5.3] [8.6]	2.1 [4.6]	85-88
		5.0 [197]	23-26	280	3.9 [11.2]	3.4 [7.6]	
		6.5 [256]	26-28	350	5.1 [12.9]	4.5 [10.0]	
		7.5 [295]	27-29	370	5.9 [15.5]	5.2 [11.5]	
		9.0 [354]	28-30	400	7.0 [15.5]	6.3 [13.8]	

⁽¹⁾Typical all weld metal. ⁽²⁾See test results disclaimer ⁽³⁾In order to meet the requirements of the G group, the undiluted weld metal shall have not less than the minimum specified for one or more of the elements listed. ⁽⁴⁾To estimate ESO, subtract 1/4 in (6.0 mm) from CTWD. NOTE: This product contains micro-alloying elements. Additional information available upon request

ULTRACORE[®] 71A75 DUAL

Mild Steel, All Position · AWS E71T-1C-H8, E71T-1M-H8, E71T-9C-H8, E71T-9M-H8

KEY FEATURES

- Designed for welding with either 100% CO₂ or 75% Argon/25% CO₂ shielding gases
- Premium arc performance and bead appearance
- ProTech[®] foil bag packaging

CONFORMANCES

- AWS A5.20:** E71T-1C-H8, E71T-1M-H8, E71T-9C-H8, E71T-9M-H8
- CWB/CSA W48:** E491T1-C1A3-CS1-H8 (E491T-9-H8),
E491T1-M21A3-CS1-H8 (E491T-9M-H8)
- ISO 17632-B:** T49 3 T1-1 C1 A H10, T49 3 T1-1 M21 A H10

WELDING POSITIONS

All

SHIELDING GAS

100% CO₂
75% Argon / 25% CO₂
Flow Rate: 40 - 50 CFH

TYPICAL APPLICATIONS

- General fabrication

DIAMETERS / PACKAGING

Diameter in (mm)	15 lb (6.8 kg) Plastic Spool 60 lb (27.2 kg) Master Carton	33 lb (15 kg) Spool*	50 lb (22.7 kg) Fiber Spool	500 lb (227 kg) Accu-Trak [®] Drum
0.045 (1.1)	ED031882	ED031669	ED031844	ED032044
0.052 (1.3)	ED031883	ED031670	ED031845	ED032045
1/16 (1.6)	ED031884	ED031671	ED031846	ED032046

*Spool may be plastic or fiber.

MECHANICAL PROPERTIES⁽¹⁾

	Yield Strength ⁽²⁾ MPa (ksi)	Tensile Strength MPa (ksi)	Elongation %	Charpy V-Notch J (ft-lbf)	
				@ -18°C (0°F)	@ -29°C (-20°F)
Requirements⁽⁴⁾ AWS A5.20 E71T-1C-H8, E71T-1M-H8 AWS A5.20 E71T-9C-H8, E71T-9M-H8	400 (58) min	480-655 (70-95)	22 min	27 (20) min Not Specified	Not Specified 27 (20) min
Typical Results⁽³⁾ As-Welded with 100% CO ₂ As-Welded with 75% Ar/25% CO ₂	510-550 (73-79) 570-610 (82-88)	570-600 (82-87) 620-660 (89-95)	26-28 24-26	38-95 (28-70) 62-111 (46-82)	27-65 (20-48) 39-85 (29-63)

DEPOSIT COMPOSITION⁽¹⁾

	%C	%Mn	%Si	%S	%P	Diffusible Hydrogen (mL/100g weld deposit)
Requirements⁽⁴⁾ AWS A5.20 E71T-1C-H8, E71T-1M-H8 AWS A5.20E71T-9C-H8, E71T-9M-H8	0.12 max	1.75 max	0.90 max	0.03 max	0.03 max	8.0 max
Typical Results⁽³⁾ As-Welded with 100% CO ₂ As-Welded with 75% Ar/25% CO ₂	0.03-0.04 0.03-0.04	1.28-1.41 1.45-1.60	0.42-0.49 0.54-0.62	0.01 0.01	0.01-0.02 0.01-0.02	3-8 4-8

TYPICAL OPERATING PROCEDURES

Diameter, Polarity Shielding Gas ⁽⁵⁾	CTWD ⁽⁶⁾ mm (in)	Wire Feed Speed m/min (in/min)	Voltage (volts)	Approx. Current (amps)	Melt-Off Rate kg/hr (lb/hr)	Deposition Rate kg/hr (lb/hr)	Efficiency (%)
0.045 in (1.1 mm), DC+ 75% Ar/25% CO ₂	25 (1)	4.4 (175)	20-25	135	1.8 (4.0)	1.6 (3.5)	86-88
		6.4 (250)	21-26	150	2.6 (5.7)	2.3 (5.0)	
		7.6 (300)	22-27	165	3.1 (6.8)	2.7 (6.0)	
		8.9 (350)	23-28	190	3.6 (8.0)	3.2 (7.0)	
		10.2 (400)	24-29	205	4.1 (9.1)	3.6 (8.0)	
		11.4 (450)	25-30	225	4.7 (10.3)	4.1 (9.0)	
		12.7 (500)	26-31	245	5.2 (11.4)	4.5 (10.0)	
		14.0 (550)	27-32	265	5.7 (12.5)	5.0 (10.9)	
15.2 (600)	27-33	285	6.2 (13.7)	5.4 (11.9)			
0.052 in (1.3 mm), DC+ 75% Ar/25% CO ₂	25 (1)	3.8 (150)	20-25	155	2.0 (4.5)	1.8 (3.9)	86-88
		5.1 (200)	21-26	165	2.7 (6.0)	2.4 (5.2)	
		6.4 (250)	22-27	190	3.4 (7.5)	2.9 (6.5)	
		7.6 (300)	23-28	215	4.1 (9.0)	3.5 (7.8)	
		8.9 (350)	24-29	235	4.7 (10.5)	4.1 (9.1)	
		9.5 (375)	25-30	255	5.1 (11.2)	4.4 (9.8)	
		10.8 (425)	27-31	275	5.8 (12.7)	5.0 (11.1)	
		12.1 (475)	28-33	295	6.4 (14.2)	5.6 (12.4)	
12.7 (500)	29-35	325	6.8 (15.0)	5.9 (13.0)			
1/16 in (1.6 mm), DC+ 75% Ar/25% CO ₂	25 (1)	3.2 (125)	20-25	195	2.4 (5.3)	2.1 (4.6)	86-88
		4.4 (175)	21-26	215	3.3 (7.4)	2.9 (6.4)	
		5.1 (200)	22-27	235	3.8 (8.4)	3.3 (7.3)	
		5.7 (225)	23-28	265	4.3 (9.5)	3.7 (8.2)	
		6.4 (250)	24-29	285	4.8 (10.5)	4.2 (9.2)	
		7.6 (300)	25-31	315	5.7 (12.6)	5.0 (11.0)	
		8.3 (325)	25-32	335	6.2 (13.7)	5.4 (11.9)	
		8.9 (350)	26-33	365	6.7 (14.7)	5.8 (12.8)	
10.2 (400)	28-35	405	7.6 (16.8)	6.6 (14.6)			

⁽¹⁾Typical all weld metal. ⁽²⁾Measured with 0.2% offset. ⁽³⁾See test results disclaimer ⁽⁴⁾As-Welded with 100% CO₂ & As-Welded 75% Argon / 25% CO₂. ⁽⁵⁾When welding under CO₂, increase voltage by 1 Volt. ⁽⁶⁾To estimate ESO, subtract 1/4 in (6.0 mm) from CTWD. NOTE: This product contains micro-alloying elements. Additional information available upon request

ULTRACORE[®] 71A85

Mild Steel, All Position · AWS E71T-1M-H8, E71T-9M-H8



KEY FEATURES

- Designed for welding with 75 - 85% Argon/balance CO₂ shielding gas
- Premium arc performance and bead appearance
- Meets AWS D1.8 seismic lot waiver requirements
- ProTech[®] foil bag packaging

WELDING POSITIONS

All

SHIELDING GAS

75% - 85% Argon / Balance CO₂
Flow Rate: 40 - 50 CFH

CONFORMANCES

- AWS A5.20:** E71T-1M-H8, E71T-9M-H8
- ABS:** 3YSA H10
- CWB/CSA W48:** E491T-9M-H8
- DNV - 2.9:** III YMS H10
- Lloyd's Register - Ch.11:** 3YS H10
- AWS D1.8:** 0.045", 0.052", 1/16"
- ISO 17632-B:** T49 3 T1-1 M21 A H10

TYPICAL APPLICATIONS

- Shipbuilding
- Seismic structural fabrication
- General fabrication

DIAMETERS / PACKAGING

Diameter in (mm)	15 lb (6.8 kg) Plastic Spool 60 lb (27.2 kg) Master Carton	33 lb (15 kg) Spool**	50 lb (22.7 kg) Fiber Spool	500 lb (227 kg) Accu-Trak [®] Drum
0.045 (1.1)	ED031885	ED031663, ED035592*	ED031847	ED032047
0.052 (1.3)	ED031886	ED031664, ED035591*	ED031848	ED032048
1/16 (1.6)	ED031887	ED031665, ED035590*	ED031849	ED032049

*Buy America Product **Spool may be plastic or fiber.

MECHANICAL PROPERTIES⁽¹⁾

	Yield Strength ⁽²⁾ MPa [ksi]	Tensile Strength MPa [ksi]	Elongation %	Charpy V-Notch J [ft-lbf]	
				@ -18°C [0°F]	@ -29°C [-20°F]
Requirements⁽⁴⁾ AWS A5.20 E71T-1M AWS A5.20 E71T-9M	400 [58] min	480-655 [70-95]	22 min	27 [20] min Not Specified	Not Specified 27 [20] min
Typical Results⁽³⁾ As-Welded with 75%-85% Ar/balance CO ₂	550-600 [80-88]	600-650 [87-94]	24 - 26	64-115 [47-85]	43-95 [32-70]

DEPOSIT COMPOSITION⁽¹⁾

	%C	%Mn	%Si	%S	%P	Diffusible Hydrogen (mL/100g weld deposit)
Requirements⁽⁴⁾ AWS A5.20 E71T-1M, E71T-9M	0.12 max	1.75 max	0.90 max	0.03 max	0.03 max	8.0 max
Typical Results⁽⁵⁾ As-Welded with 75%-85% Ar/balance CO ₂	0.03-0.04	1.43-1.56	0.52-0.59	<0.01	0.01	6-8

TYPICAL OPERATING PROCEDURES

Diameter, Polarity Shielding Gas	CTWD ⁽⁶⁾ mm (in)	Wire Feed Speed m/min (in/min)	Voltage (volts)	Approx. Current (amps)	Melt-Off Rate kg/hr (lb/hr)	Deposition Rate kg/hr (lb/hr)	Efficiency (%)
0.045 in (1.1 mm), DC+ 75%-85% Ar/ balance CO ₂	25 (1)	4.4 (175)	21-26	125	1.8 (4.0)	1.6 (3.5)	86-88
		6.4 (250)	22-27	150	2.6 (5.7)	2.3 (5.0)	
		7.6 (300)	23-28	165	3.1 (6.8)	2.7 (6.0)	
		8.9 (350)	23-29	190	3.6 (8.0)	3.2 (7.0)	
		10.2 (400)	25-30	205	4.1 (9.1)	3.6 (8.0)	
		11.4 (450)	26-31	225	4.7 (10.3)	4.1 (9.0)	
		12.7 (500)	27-32	245	5.2 (11.4)	4.5 (10.0)	
		14.0 (550)	28-33	265	5.7 (12.5)	5.0 (10.9)	
15.2 (600)	28-34	280	6.2 (13.7)	5.4 (11.9)			
0.052 in (1.3 mm), DC+ 75%-85% Ar/ balance CO ₂	25 (1)	3.8 (150)	21-26	150	2.0 (4.5)	1.8 (3.9)	86-88
		5.1 (200)	21-27	165	2.7 (6.0)	2.4 (5.2)	
		6.4 (250)	22-27	190	3.4 (7.5)	2.9 (6.5)	
		7.6 (300)	23-28	215	4.1 (9.0)	3.5 (7.8)	
		8.9 (350)	24-29	235	4.7 (10.5)	4.1 (9.1)	
		9.5 (375)	25-30	255	5.1 (11.2)	4.4 (9.8)	
		10.8 (425)	26-31	275	5.8 (12.7)	5.0 (11.1)	
		12.1 (475)	27-32	295	6.4 (14.2)	5.6 (12.4)	
12.7 (500)	27-33	315	6.8 (15.0)	5.9 (13.0)			
1/16 in (1.6 mm), DC+ 75%-85% Ar/ balance CO ₂	25 (1)	3.2 (125)	20-25	185	2.4 (5.3)	2.1 (4.6)	86-88
		4.4 (175)	21-26	215	3.3 (7.4)	2.9 (6.4)	
		5.1 (200)	22-27	235	3.8 (8.4)	3.3 (7.3)	
		5.7 (225)	23-28	265	4.3 (9.5)	3.7 (8.2)	
		6.4 (250)	24-29	285	4.8 (10.5)	4.2 (9.2)	
		7.6 (300)	25-30	315	5.7 (12.6)	5.0 (11.0)	
		8.3 (325)	26-31	335	6.2 (13.7)	5.4 (11.9)	
		8.9 (350)	27-32	365	6.7 (14.7)	5.8 (12.8)	
10.2 (400)	28-33	385	7.6 (16.8)	6.6 (14.6)			

⁽¹⁾Typical all weld metal. ⁽²⁾Measured with 0.2% offset. ⁽³⁾See test results disclaimer ⁽⁴⁾As-Welded with 75%-85% Argon/Balance CO₂ ⁽⁵⁾To estimate ESO, subtract 1/4 in (6.0 mm) from CTWD.
NOTE 1: FEMA and AWS D1.8 structural steel seismic supplement test data can be found on this product at www.lincolnelectric.com. NOTE 2: This product contains micro-alloying elements.
Additional information available upon request.

ULTRACORE[®] 712C

Mild Steel, All Position · AWS E71T-12C-JH8, E71T-1C-JH8, E71T-9C-JH8



KEY FEATURES

- Capable of producing weld deposits with impact toughness exceeding 27 J (20 ft-lbf) at -40°C (-40°F)
- Designed for welding with 100% CO₂ shielding gas
- Premium arc performance and bead appearance
- ProTech[®] foil bag packaging

WELDING POSITIONS

All

SHIELDING GAS

100% CO₂
Flow Rate: 40-50 CFH

CONFORMANCES

AWS A5.20:	E71T-12C-JH8, E71T-1C-JH8, E71T-9C-JH8
ABS:	3YSA H10
CWB/CSA W48::	E491T-9J-H8, E491T-12J-H8
DNV - 2.9:	III YMS H10
Lloyd's Register:	3YS H10
AWS D1.8:	1/16"
ISO 17632-B:	T49 4 T12-1 C1 A-K H10

TYPICAL APPLICATIONS

- Bridge fabrication
- Pressure vessels
- Shipbuilding
- Offshore
- ASME related applications

DIAMETERS / PACKAGING

Diameter in (mm)	15 lb (6.8 kg) Plastic Spool 60 lb (27.2 kg) Master Carton	33 lb (15 kg) Spool**	50 lb (22.7 kg) Fiber Spool	500 lb (227 kg) Accu-Trak [®] Drum
0.045 (1.1)	ED031894	ED031672, ED032754*		ED031681
0.052 (1.3)	ED031895	ED031673, ED034418*	ED031839, ED034420*	ED031879
1/16 (1.6)	ED031896	ED031674, ED034419*	ED031840, ED034421*	ED031799

*Buy America Product **Spool may be plastic or fiber.

MECHANICAL PROPERTIES⁽¹⁾

	Yield Strength ⁽²⁾ MPa (ksi)	Tensile Strength MPa (ksi)	Elongation %	Charpy V-Notch J (ft-lbf)		
				@ -18°C (0°F)	@ -29°C (-20°F)	@ -40°C (-40°F)
Requirements⁽⁴⁾ AWS A5.20 E71T-1C-JH8 AWS A5.20 E71T-9C-JH8 AWS A5.20 E71T-12C-JH8	400 (58) min	480-655 (70-95) 480-620 (70-90)	22 min	27 (20) min Not Specified Not Specified	Not Specified 27 (20) min 27 (20) min	27 (20) min
Typical Results⁽³⁾ As-Welded with 100% CO ₂	485-535 (70-77)	540-585 (78-84)	25-28	135-193 (100-143)	91-164 (67-121)	57-133 (42-98)

DEPOSIT COMPOSITION⁽¹⁾

	%C	%Mn	%Si	%S	%P	%Ni	Diffusible Hydrogen (mL/100g weld deposit)
Requirements⁽⁴⁾ AWS A5.20 E71T-1C-JH8, E71T-9C-JH8 AWS A5.20 E71T-12C-JH8	0.12 max	1.75 max 1.60 max	0.90 max	0.03 max	0.03 max	0.50 max	8.0 max
Typical Results⁽³⁾ As-Welded with 100% CO ₂	0.03	1.34-1.49	0.26-0.32	0.01	0.01-0.02	0.33-0.41	3-8

TYPICAL OPERATING PROCEDURES

Diameter, Polarity Shielding Gas	CTWD ⁽²⁾ mm (in)	Wire Feed Speed m/min (in/min)	Voltage (volts)	Approx. Current (amps)	Melt-Off Rate kg/hr (lb/hr)	Deposition Rate kg/hr (lb/hr)	Efficiency (%)
0.045 in (1.1 mm), DC+ As-Welded with 100% CO ₂	25 (1)	4.4 (175)	24-29	115	1.8 (3.9)	1.5 (3.4)	85-88
		6.4 (250)	25-30	140	2.5 (5.6)	2.2 (4.8)	
		7.6 (300)	26-31	155	3.1 (6.8)	2.6 (5.8)	
		8.9 (350)	26-31	170	3.6 (7.9)	3.1 (6.8)	
		10.2 (400)	26-31	185	4.1 (9.0)	3.5 (7.8)	
		11.4 (450)	27-32	200	4.6 (10.1)	4.0 (8.8)	
		12.7 (500)	27-32	215	5.1 (11.3)	4.4 (9.8)	
		14.0 (550)	28-33	230	5.6 (12.4)	4.9 (10.8)	
		15.2 (600)	28-33	245	6.1 (13.5)	5.3 (11.7)	
0.052 in (1.3 mm), DC+ As-Welded with 100% CO ₂	25 (1)	3.8	24-29	140	2.1 (4.7)	1.7 (3.8)	85-88
		5.1 (150)	25-30	160	2.9 (6.3)	2.4 (5.2)	
		6.4 (200)	26-31	180	3.5 (7.8)	3.0 (6.5)	
		7.6 (250)	26-31	205	4.3 (9.4)	3.6 (7.9)	
		8.9 (300)	27-32	225	5.0 (11.0)	4.2 (9.2)	
		9.5 (350)	27-32	235	5.3 (11.7)	4.5 (9.9)	
		10.8 (375)(425)	27-32	255	6.0 (13.3)	5.1 (11.2)	
		12.1 (475)(500)	28-33	275	6.8 (14.9)	5.7 (12.6)	
		12.7	28-33	290	7.1 (15.6)	6.0 (13.3)	
1/16 in (1.6 mm), DC+ As-Welded with 100% CO ₂	25 (1)	3.8	23-28	200	2.9 (6.4)	2.4 (5.3)	85-88
		4.4	24-29	215	3.4 (7.5)	2.9 (6.3)	
		5.1 (150)(175)	24-29	230	3.9 (8.5)	3.3 (7.2)	
		5.7 (200)(225)	24-29	245	4.4 (9.6)	3.7 (8.1)	
		6.4 (250)(300)	25-30	255	4.8 (10.6)	4.1 (9.1)	
		7.6 (325)(350)	25-30	285	5.8 (12.7)	4.9 (10.9)	
		8.3 (400)	26-31	300	6.3 (13.8)	5.4 (11.9)	
		8.9	26-31	310	6.7 (14.8)	5.8 (12.8)	
		10.2	27-32	340	7.7 (16.9)	6.7 (14.7)	

⁽¹⁾Typical all weld metal. ⁽²⁾Measured with 0.2% offset. ⁽³⁾See test results disclaimer ⁽⁴⁾As-Welded with 100% CO₂. ⁽⁵⁾To estimate ESO, subtract 1/4 in [6.0 mm] from CTWD.
NOTE: This product contains micro-alloying elements. Additional information available upon request.

ULTRACORE® 712C-H PLUS

Mild Steel, All Positions · E71T-12C-JH4, E81T1-GC

KEY FEATURES

- Innovative design capable of superior toughness at -50°F in both the as-welded and stress-relieved conditions
- Designed for welding with 100% CO₂ shielding gas
- H4 diffusible hydrogen levels
- Q2 Lot® - Certificate showing actual deposit chemistry and mechanical properties per lot available online
- ProTech® foil bag packaging

CONFORMANCES

- AWS A5.20:** E71T-12C-JH4
AWS A5.29: E81T1-GC
ABS: 4YSA H5
CWB/CSA W48:: E491T-12J-H4
DNV - 2.9: IV Y40MS H5
Lloyd's Register: 4YS H5

WELDING POSITIONS

All

SHIELDING GAS

100% CO₂
 Flow Rate: 40-50 CFH

TYPICAL APPLICATIONS

- Offshore platforms & pipe systems
- Oil & gas pipelines
- Pressure vessels
- Petrochemical pipelines
- Bridge fabrication

DIAMETERS / PACKAGING

Diameter in (mm)	33 lb (15kg) Plastic Spool
0.045 (1.1)	ED034849
0.052 (1.3)	ED034848
1/16 (1.6)	ED034850

MECHANICAL PROPERTIES⁽¹⁾

	Yield Strength ⁽²⁾ MPa (ksi)	Tensile Strength MPa (ksi)	Elongation (%)	Charpy V-Notch J (ft-lbf)		
				-40°C (40°F)	-46°C (-50°F)	@ -51°C (-60°F)
Requirements AWS A5.20: E71T-12C-JH4 As-Welded with 100% CO ₂	400 (58) min	480-620 (70-90)	22 min	27 (20) min	-	-
AWS A5.29: E81T1-GC as welded with 100% CO ₂ requirements:	470 (68) min	550-690 (80-100) min	19 min	-	-	-
Typical Results⁽³⁾ As-Welded with 100% CO ₂	490-530 (71-77)	560-585 (81-85)	25-27	89-156 (66-115)	73-148 (54-109)	66-132 (49-97)
Stress Relieved with 100% CO ₂ for 1 hr @ 621°C (1150°F)	420-470 (61-68)	530-565 (77-82)	29-34	115-178 (85-131)	95-148 (70-109)	-

⁽¹⁾ Typical all weld metal. ⁽²⁾ Measure with 0.2% offset. ⁽³⁾ See test results disclaimer

DEPOSIT COMPOSITION⁽¹⁾

	%C	%Mn	%Si	%S
Requirements AWS A5.20: E71T-12C-JH4	0.12 max	1.60 max	0.90 max	0.03 max
AWS A5.29 E81T1-GC requirements:	–	0.50 min	1.00 max	0.030 max
Typical Results⁽²⁾ with 100% CO ₂	0.04-0.05	1.48-1.57	0.45-0.50	0.008
	%P	%Ni	Diffusible Hydrogen (mL/100g weld deposit)	
Requirements AWS A5.20: E71T-12C-JH4	0.03 max	0.50 max	4.0 max	
AWS A5.29 E81T1-GC requirements:	0.030 max	0.50 max	–	
Typical Results⁽³⁾ with 100% CO ₂	0.013	0.02	2-4	

TYPICAL OPERATING PROCEDURES

Diameter, Polarity Shielding Gas	CTWD ⁽⁴⁾ mm (in)	Wire Feed Speed m/min (in/min)	Voltage (Volts)	Approx. Current (amps)	Melt-Off Rate kg/hr (lb/hr)	Deposition Rate kg/hr (lb/hr)	Efficiency (%)
0.045 in (1.1 mm), DC+ 100% CO₂							
Optimal Settings	22 [7/8]	11.2 [440]	29	220	1.8-6.1 [3.9-13.5]	1.5-5.1 [3.4-11.3]	83-88
Min - Max	19-25 [3/4-1]	4.4-13.3 [175-525]	23-32	115-245			
0.052 in (1.3 mm), DC+ 100% CO₂							
Optimal Settings	25 [1]	8.6 [340]	30	235	2.1-7.1 [4.7-15.6]	1.7-6.0 [3.8-13.3]	80-86
Min - Max	19-25 [3/4-1]	3.8-10.2 [150-400]	23-32	140-290			
1/16 in (1.6 mm), DC+ 100% CO₂							
Optimal Settings	25 [1]	7.6 [300]	28	295	2.9-6.7 [6.4-14.8]	2.4-5.8 [5.3-12.8]	82-87
Min - Max	19-25 [3/4-1]	3.8-8.9 [150-350]	22-31	200-360			

⁽¹⁾ Typical all weld metal. ⁽²⁾ See test results disclaimer ⁽³⁾ To estimate ESO, subtract 1/4 in [6.0 mm] from CTWD.

ULTRACORE® 712A80

Mild Steel, All Position · AWS E71T-12M-JH8, E71T-1M-JH8, E71T-9M-JH8



KEY FEATURES

- Capable of producing weld deposits with impact toughness exceeding 27 J (20 ft·lbf) at -40°C [-40°F]
- Designed for welding with 75-80% Argon/balance CO₂ shielding gas
- Premium arc performance and bead appearance
- ProTech® foil bag packaging

WELDING POSITIONS

All

SHIELDING GAS

75% - 80% Argon / Balance CO₂
Flow Rate: 40 - 50 CFH

CONFORMANCES

AWS A5.20:	E71T-12M-JH8, E71T-1M-JH8, E71T-9M-JH8
ABS:	4YSA H10
CWB/CSA W48:	E491T1-M21A4-CS1-H8 [E491T-9MJ-H8], E491T1-M21A4-CS2-H8 [E491T-12MJ-H8]
DNV - 2.9:	IV YMS H10
Lloyd's Register:	4YS H10
ISO 17632-B:	T49 4 T12-1 M21 A-K H10

TYPICAL APPLICATIONS

- Offshore
- Pressure vessels
- Shipbuilding
- Heavy equipment
- ASME related applications

DIAMETERS / PACKAGING

Diameter in (mm)	15 lb (6.8 kg) Plastic Spool 60 lb (27.2 kg) Master Carton	33 lb (15 kg) Spool**	50 lb (22.7 kg) Fiber Spool	500 lb (227 kg) Accu-Trak® Drum
0.045 (1.1)		ED031675	ED031850	ED032050
0.052 (1.3)	ED035405	ED031676	ED031851	ED032051
1/16 (1.6)	ED031890	ED031677, ED036415*	ED031852	ED032052

*Buy America Product **Spool may be plastic or fiber.

MECHANICAL PROPERTIES⁽¹⁾

	Yield Strength ⁽²⁾ MPa (ksi)	Tensile Strength MPa (ksi)	Elongation %	Charpy V-Notch J (ft·lbf)		
				@ -18°C [0°F]	@ -29°C [-20°F]	@ -40°C [-40°F]
Requirements⁽⁴⁾ AWS A5.20 E71T-1M-JH8 AWS A5.20 E71T-9M-JH8 AWS A5.20 E71T-12M-JH8	400 [58] min	480-655 [70-95] 480-620 [70-90]	22 min	27 [20] min Not Specified Not Specified	Not Specified 27 [20] min 27 [20] min	27 [20] min
Typical Results⁽³⁾ As-Welded with 75%-80% Ar/balance CO ₂	505-555 [73-80]	565-610 [82-88]	25-27	166-186 [123-137]	100-160 [74-118]	72-142 [53-105]

⁽¹⁾Typical all weld metal. ⁽²⁾Measured with 0.2% offset. ⁽³⁾See test results disclaimer ⁽⁴⁾As-Welded 75%-80% Argon/Balance CO₂.

DEPOSIT COMPOSITION⁽¹⁾

	%C	%Mn	%Si	%S	%P	%Ni	Diffusible Hydrogen (mL/100g weld deposit)
Requirements⁽⁴⁾							
AWS A5.20 E71T-1M-JH8, E71T-9M-JH8	0.12	1.75 max	0.90	0.03	0.03	0.50	8.0
AWS A5.20 E71T-12M-JH8	max	1.60 max	max	max	max	max	max
Typical Results⁽⁵⁾							
As-Welded with 75%-80% Ar/balance CO ₂	0.03-0.04	1.40-1.53	0.31-0.36	0.01	0.01	0.32-0.38	4 - 8

TYPICAL OPERATING PROCEDURES

Diameter, Polarity Shielding Gas	CTWD ⁽⁶⁾ mm (in)	Wire Feed Speed m/min (in/min)	Voltage (volts)	Approx. Current (amps)	Melt-Off Rate kg/hr (lb/hr)	Deposition Rate kg/hr (lb/hr)	Efficiency (%)
0.045 in (1.1 mm), DC+ 75%-80% Ar/ balance CO ₂	25 (1)	4.4 (175)	20-25	140	1.8 (4.0)	1.6 (3.5)	86-88
		5.7 (225)	21-26	150	2.3 (5.1)	2.0 (4.5)	
		7.0 (275)	22-27	165	2.8 (6.3)	2.5 (5.5)	
		8.3 (325)	22-27	190	3.4 (7.4)	2.9 (6.5)	
		8.9 (350)	23-28	205	3.6 (8.0)	3.2 (7.0)	
		10.2 (400)	24-29	230	4.1 (9.1)	3.6 (8.0)	
		11.4 (450)	25-31	245	4.7 (10.3)	4.1 (9.0)	
		12.1 (475)	26-32	265	4.9 (10.8)	4.3 (9.5)	
0.052 in (1.3 mm), DC+ 75%-80% Ar/ balance CO ₂	25 (1)	3.8 (150)	20-25	150	2.0 (4.5)	1.8 (3.9)	86-88
		4.4 (175)	21-26	165	2.4 (5.2)	2.1 (4.6)	
		5.1 (200)	22-27	190	2.7 (6.0)	2.4 (5.2)	
		5.7 (225)	23-28	215	3.1 (6.7)	2.7 (5.9)	
		6.4 (250)	24-29	235	3.4 (7.5)	2.9 (6.5)	
		7.6 (300)	25-30	255	4.1 (9.0)	3.5 (7.8)	
		8.3 (325)	27-31	275	4.4 (9.7)	3.8 (8.5)	
		8.9 (350)	28-32	295	4.7 (10.5)	4.1 (9.1)	
1/16 in (1.6 mm), DC+ 75%-80% Ar/ balance CO ₂	25 (1)	3.8 (150)	21-26	200	2.9 (6.3)	2.5 (5.5)	86-88
		4.4 (175)	22-27	215	3.3 (7.4)	2.9 (6.4)	
		5.1 (200)	22-28	235	3.8 (8.4)	3.3 (7.3)	
		5.7 (225)	24-29	265	4.3 (9.5)	3.7 (8.2)	
		6.4 (250)	25-30	285	4.8 (10.5)	4.2 (9.2)	
		7.6 (300)	26-31	315	5.7 (12.6)	5.0 (11.0)	
		8.3 (325)	27-32	335	6.2 (13.7)	5.4 (11.9)	
		8.9 (350)	28-33	365	6.7 (14.7)	5.8 (12.8)	
10.2 (400)	29-34	415	7.6 (16.8)	6.6 (14.6)			

⁽¹⁾Typical all weld metal. ⁽²⁾Measured with 0.2% offset. ⁽³⁾See test results disclaimer ⁽⁴⁾As-Welded 75%-80% Argon/Balance CO₂. ⁽⁵⁾To estimate ESO, subtract 1/4 in (6.0 mm) from CTWD.

ULTRACORE® 712A80-H PLUS

Mild Steel, All Positions · AWS E71T-12M-JH4, E71T-1M-JH4, E71T-9M-JH4, E81T1-GM

KEY FEATURES

- Innovative design capable of superior toughness at -50°F in both the as-welded and stress-relieved conditions
- Designed for welding with 75-80% Argon/Balance CO₂ shielding gas
- H4 diffusible hydrogen levels
- Q2 Lot® - Certificate showing actual deposit chemistry and mechanical properties per lot available online
- ProTech® foil bag packaging

CONFORMANCES

- AWS A5.20:** E71T-12M-JH4, E71T-1M-JH4, E71T-9M-JH4
AWS 5.29: E81T1-GM
- ABS:** 4YSA H5
- CWB/CSA W48:** E491T1-M21A5-CS2-H4 [E491T-12MJ-H4]
- DNV - 2.9:** IV YMS H5
- Lloyd's Register:** 4YS H5

WELDING POSITIONS

All

SHIELDING GAS

75-80% Argon / Balance CO₂
 Flow Rate: 40-50 CFH

TYPICAL APPLICATIONS

- Offshore Platforms & Pipe Systems
- Oil & Gas Pipelines
- Petrochemical Pipelines
- Pressure Vessels
- Bridge Fabrication

DIAMETERS / PACKAGING

Diameter in (mm)	33 lb (15kg) Plastic Spool
0.045 (1.1)	ED034845
0.052 (1.3)	ED034846
1/16 (1.6)	ED034847

MECHANICAL PROPERTIES⁽¹⁾

	Yield Strength ⁽²⁾ MPa (ksi)	Tensile Strength MPa (ksi)	Elongation (%)	Charpy V-Notch J [ft-lbf]		
				-40°C [40°F]	-46°C [-50°F]	@ -51°C [-60°F]
Requirements						
AWS A5.20: E71T-12M-JH4 As-Welded with 75-80% Ar/balance CO ₂	400 (58) min	480-620 (70-90)	22 min	27 (20) min	-	-
AWS A5.29: E81T1-GM As-Welded with 75-80% Ar/balance CO ₂	470 (68) min	550-690 (80-100)	19 min	-	-	-
Typical Results⁽³⁾						
As-Welded with 75-80% Ar/balance CO ₂	530-545 (77-79)	590-605 (86-88)	26-28	95-150 (69-112)	65-145 (49-106)	75-140 (55-102)
Stress Relieved with 75-80% Ar/balance CO ₂ for 1 hr @ 621°C (1150°F)	445-470 (65-68)	545-565 (79-82)	31-33	85-150 (62-109)	60-125 (43-91)	-

⁽¹⁾ Typical all weld metal. ⁽²⁾ Measure with 0.2% offset. ⁽³⁾ See test results disclaimer

DEPOSIT COMPOSITION⁽¹⁾

	%C	%Mn	%Si	%S
Requirements AWS A5.20: E71T-12M-JH4	0.12 max	1.60 max	0.90 max	0.03 max
A5.29 E81T1-GM requirements:	–	0.50 min	1.00 max	0.030 max
Typical Results⁽²⁾ with 75-80% Ar / Balance CO ₂	0.04-0.05	1.40-1.48	0.44-0.46	0.008
	%P	%Ni	Diffusible Hydrogen (mL/100g weld deposit)	
Requirements AWS A5.20: E71T-12M-JH4	0.03 max	–	4.0 max	
A5.29 E81T1-GM requirements:	0.030 max	0.50 min	4 max	
Typical Results⁽²⁾ with 75-80% Ar / Balance CO ₂	0.015	0.04	2-4	

TYPICAL OPERATING PROCEDURES

Diameter, Polarity Shielding Gas	CTWD ⁽⁴⁾ mm (in)	Wire Feed Speed m/min (in/min)	Voltage (Volts)	Approx. Current (amps)	Melt-Off Rate kg/hr (lb/hr)	Deposition Rate kg/hr (lb/hr)	Efficiency (%)	
0.045 in (1.1 mm), DC+ 75-80% Ar/balance CO ₂	Optimal Settings	22 (7/8)	11.2 (440)	28	220	1.8-5.2 (4.0-11.4)	1.6-4.7 (3.5-10.4)	84-91
	Min - Max	19-25 (3/4-1)	4.4-12.7 (175-500)	21-33	140-275			
0.052 in (1.3 mm), DC+ 75-80% Ar/balance CO ₂	Optimal Settings	25 (1)	8.6 (340)	29	235	2.0-5.4 (4.5-12.0)	1.8-4.7 (3.9-10.4)	84-87
	Min - Max	19-25 (3/4-1)	3.8-10.2 (150-400)	21-33	150-310			
1/16 in (1.6 mm), DC+ 75-80% Ar/balance CO ₂	Optimal Settings	25 (1)	7.6 (300)	27	295	2.9-6.7 (6.3-14.7)	2.5-5.8 (5.5-12.8)	83-87
	Min - Max	19-25 (3/4-1)	3.8-8.9 (150-350)	22-33	200-365			

⁽¹⁾ Typical all weld metal. ⁽²⁾ See test results disclaimer ⁽⁴⁾ To estimate ESO, subtract 1/4 in (6.0 mm) from CTWD.

ULTRACORE® HD-C

Mild Steel, All Position · AWS E71T-1C-H8, E71T-9C-H8



KEY FEATURES

- High deposition rates, increase weld deposition exceeding 10 lbs/hr out-of-position
- Fast freezing slag for a flat bead shape and increased productivity in all positions, including vertical up
- Operators can set the machine on a single setting and weld in all positions
- Little or no pre-weld clean up required, weld over light rust, mill scale, and primer
- Meets AWS D1.8 seismic lot waiver requirements

CONFORMANCES

- AWS A5.20:** E71T-1C-H8, E71T-9C-H8
- ABS:** 3YSA H10
- CWB/CSA W48:** E491T1-C1A3-CS1-H8 (E491T-9-H8)
- DNV - 2.9:** III YMS H10
- Lloyd's Register:** 3YS H10
- ISO 17632-B** T49 3 T1-1 C1 A H10
- AWS D1.8:** 0.045", 0.052", 1/16"

WELDING POSITIONS

All

TYPICAL APPLICATIONS

- Shipbuilding
- General fabrication

SHIELDING GAS

100% CO₂
Flow Rate: 40 - 50 CFH

DIAMETERS / PACKAGING

Diameter in (mm)	15 lb (6.8 kg) Plastic Spool 60 lb (27.2 kg) Master Carton	33 lb (15 kg) Spool**	50 lb (22.7 kg) Fiber Spool	50 lb (22.7 kg) Coil	500 lb (227 kg) Accu-Trak® Drum
0.045 (1.1)	ED033756	ED033755	ED033757		
0.052 (1.3)	ED033759	ED033758	ED033760		ED034376
1/16 (1.6)	ED033762	ED033761	ED033763	ED036529*	ED033785

*Buy America Product **Spool may be plastic or fiber.

MECHANICAL PROPERTIES⁽¹⁾

	Yield Strength ⁽²⁾ MPa (ksi)	Tensile Strength MPa (ksi)	Elongation %	Charpy V-Notch J (ft-lbf)	
				@ -18°C (0°F)	@ -29°C (-20°F)
Requirements AWS A5.20 E71T-1C-H8 AWS A5.20 E71T-9C-H8	400 (58) min	480-660 (70-95)	22 min	27 (20) min Not Specified	Not Specified 27 (20) min
Test Results⁽³⁾ - As-Welded with 100% CO ₂	540-560 (78-81)	590-610 (86-89)	27	37-111 (27-82)	31-85 (23-63)

⁽¹⁾Typical all weld metal. ⁽²⁾Measured with 0.2% offset. ⁽³⁾See test results disclaimer

DEPOSIT COMPOSITION⁽¹⁾

	%C	%Mn	%Si
Requirements - AWS E71T-1C-H8, E71T-9C-H8	0.12 max	1.75 max	0.90 max
Test Results⁽²⁾ - As-Welded with 100% CO ₂	0.04-0.05	1.36-1.46	0.38-0.42
	%S	%P	Diffusible Hydrogen (mL/100g weld deposit)
Requirements - AWS E71T-1C-H8, E71T-9C-H8	0.03 max	0.03 max	8 max
Test Results⁽³⁾ - As-Welded with 100% CO ₂	0.01	0.01	4-6

TYPICAL OPERATING PROCEDURES

Diameter, Polarity Shielding Gas	CTWD ⁽⁴⁾ mm (in)	Wire Feed Speed m/min (in/min)	Voltage (Volts)	Approx. Current (Amps)	Melt-Off Rate kg/hr (lb/hr)	Deposition Rate kg/hr (lb/hr)	Efficiency (%)
0.045 in (1.1 mm), DC+ 100% CO ₂	19 - 25 (3/4 - 1)	4.4 (175)	22-25	145	1.8 (3.9)	1.5 (3.4)	85 - 87
		6.4 (250)	23-28	185	2.5 (5.6)	2.2 (4.8)	
		7.6 (300)	24-30	215	3.1 (6.8)	2.6 (5.8)	
		8.9 (350)	25-31	235	3.6 (7.9)	3.1 (6.8)	
		10.2 (400)	27-32	255	4.1 (9.0)	3.5 (7.8)	
		11.4 (450)	28-33	280	4.6 (10.1)	4.0 (8.8)	
		12.7 (500)	27-33	300	5.1 (11.3)	4.4 (9.8)	
		14.0 (550)	28-33	315	5.6 (12.4)	4.9 (10.8)	
15.2 (600)	30-35	335	6.1 (13.5)	5.3 (11.7)			
0.052 in (1.3 mm), DC+ 100% CO ₂	19 - 25 (3/4 - 1)	3.8 (150)	22-25	155	2.1 (4.7)	1.7 (3.8)	81 - 85
		5.1 (200)	23-26	190	2.9 (6.3)	2.4 (5.2)	
		6.4 (250)	23-27	225	3.5 (7.8)	2.9 (6.5)	
		7.6 (300)	24-29	265	4.3 (9.4)	3.6 (7.9)	
		8.9 (350)	26-30	285	5.0 (11.0)	4.2 (9.2)	
		9.5 (375)	27-30	310	5.3 (11.7)	4.5 (9.9)	
		10.8 (425)	28-32	325	6.0 (13.3)	5.1 (11.2)	
		12.1 (475)	29-33	345	6.8 (14.9)	5.7 (12.6)	
12.7 (500)	30-34	360	7.1 (15.6)	6.0 (13.3)			
1/16 in (1.6 mm), DC+ 100% CO ₂	19 - 25 (3/4 - 1)	3.8 (150)	21-26	195	2.9 (6.4)	2.4 (5.3)	84 - 87
		4.4 (175)	22-27	245	3.4 (7.5)	2.9 (6.3)	
		5.1 (200)	22-27	260	3.9 (8.5)	3.3 (7.2)	
		5.7 (225)	23-28	290	4.4 (9.6)	3.7 (8.1)	
		6.4 (250)	24-29	310	4.8 (10.6)	4.1 (9.1)	
		7.6 (300)	25-30	330	5.8 (12.7)	4.9 (10.9)	
		8.3 (325)	25-30	365	6.3 (13.8)(14.8)	5.4 (11.9)	
		8.9 (350)	26-30	390	6.7 (16.9)	5.8 (12.8)	
10.2 (400)	27-31	405	7.7	6.7 (14.7)			

⁽¹⁾Typical all weld metal. ⁽²⁾Measured with 0.2% offset. ⁽³⁾See test results disclaimer ⁽⁴⁾As-Welded with 100% CO₂. ⁽⁵⁾To estimate ESO, subtract 1/4 in (6.0 mm) from CTWD.

ULTRACORE® HD-M

Mild Steel, All Position · AWS E71T-1M-H8, E71T-9M-H8



KEY FEATURES

- Increase weld deposition to more than 10 lbs./hr. out-of-position
- Fast freezing slag for a flat bead shape and increased productivity in all positions, including vertical up
- Operators can set the machine on a single setting and weld in all positions

WELDING POSITIONS

All

SHIELDING GAS

75% Argon / Balance CO₂
Flow Rate: 40 - 50 CFH

CONFORMANCES

AWS A5.20:	E71T-1M-H8, E71T-9M-H8
ABS:	3YSA H10
CWB/CSA W48:	E491T1-M21A3-CS1-H8 (E491T-9M-H8)
DNV - 2.9:	III YMS H10
Lloyd's Register:	3YS H10
ISO 17632-B:	T49 3 T1-1 M21 A H10

TYPICAL APPLICATIONS

- Shipbuilding
- General fabrication

DIAMETERS / PACKAGING

Diameter in (mm)	15 lb (6.8 kg) Plastic Spool 60 lb (27.2 kg) Master Carton	33 lb (15 kg) Fiber Spool (Plastic Bag)	50 lb (23 kg) Fiber Spool (Plastic Bag)
0.045 (1.1)	ED033986	ED033989	ED033992
0.052 (1.3)	ED033987	ED033990	ED033993
1/16 (1.6)	ED033988	ED033991, ED036619*	ED033994

*Buy America Product

MECHANICAL PROPERTIES⁽¹⁾

	Yield Strength ⁽²⁾ MPa (ksi)	Tensile Strength MPa (ksi)	Elongation %	Charpy V-Notch J (ft-lbf)	
				@ -18°C (0°F)	@ -29°C (-20°F)
Requirements AWS A5.20 E71T-1M-H8 AWS A5.20 E71T-9M-H8	400 [58] min	480-655 (70-95)	22 min	27 [20] min Not Specified	Not Specified 27 [20] min
Test Results⁽³⁾ As-Welded with 75% Argon / 25% CO ₂	570-588 [83-85]	615-633 [89-92]	26-28	54-74 [40-54]	31-43 [23-32]

⁽¹⁾Typical all weld metal. ⁽²⁾Measured with 0.2% offset. ⁽³⁾See test results disclaimer

DEPOSIT COMPOSITION⁽¹⁾

	%C	%Mn	%Si	%S	%P	Diffusible Hydrogen (mL/100g weld deposit)
Requirements AWS E71T-1M-H8, E71T-9M-H8	0.12 max	1.75 max	0.90 max	0.03 max	0.03 max	8 max
Test Results⁽²⁾ As-Welded with 75% Argon / 25% CO ₂	0.04-0.05	1.44-1.50	0.49-0.53	<0.01	0.01	3-7

TYPICAL OPERATING PROCEDURES

Diameter, Polarity Shielding Gas	CTWD ⁽⁴⁾ mm (in)	Wire Feed Speed m/min (in/min)	Voltage (Volts)	Approx. Current (Amps)	Melt-Off Rate kg/hr (lb/hr)	Deposition Rate kg/hr (lb/hr)	Efficiency (%)
0.045 in (1.1 mm), DC+ 75% Argon / 25% CO ₂	25 (1)	4.4 (175)	21-26	130	1.8 (4.0)	1.6 (3.5)	87 - 88
		6.4 (250)	22-27	155	2.6 (5.7)	2.3 (5.0)	
		7.6 (300)	23-28	170	3.1 (6.9)	2.7 (6.0)	
		8.9 (350)	23-29	190	3.6 (8.0)	3.2 (7.0)	
		10.2 (400)	25-30	205	4.1 (9.1)	3.6 (8.0)	
		11.4 (450)	26-31	225	4.7 (10.3)	4.1 (9.0)	
		12.7 (500)	27-33	230	5.2 (11.4)	4.5 (9.9)	
		14.0 (550)	28-33	245	5.7 (12.6)	4.9 (10.9)	
0.052 in (1.3 mm), DC+ 75% Argon / 25% CO ₂	25 (1)	3.8 (150)	22-26	145	2.0 (4.5)	1.8 (3.9)	87 - 88
		5.1 (200)	23-27	170	2.7 (6.0)	2.4 (5.2)	
		6.4 (250)	23-28	190	3.4 (7.5)	2.9 (6.5)	
		7.6 (300)	24-29	215	4.1 (9.0)	3.5 (7.8)	
		8.9 (350)	24-30	235	4.8 (10.5)	4.1 (9.1)	
		9.5 (375)	25-30	250	5.1 (11.2)	4.4 (9.8)	
		10.8 (425)	26-31	270	5.8 (12.7)	5.0 (11.1)	
		12.1 (475)	26-32	295	6.4 (14.2)	5.6 (12.4)	
1/16 in (1.6 mm), DC+ 75% Argon / 25% CO ₂	25 (1)	3.8 (150)	22 - 26	195	2.9 (6.3)	2.5 (5.5)	86 - 87
		4.4 (175)	23 - 26	215	3.4 (7.4)	2.9 (6.4)	
		5.1 (200)	23 - 27	235	3.8 (8.4)	3.3 (7.3)	
		5.7 (225)	24 - 28	255	4.3 (9.5)	3.7 (8.2)	
		6.4 (250)	25 - 29	270	4.8 (10.5)	4.1 (9.1)	
		7.6 (300)	25 - 30	310	5.7 (12.6)	5.0 (11.0)	
		8.3 (325)	26 - 31	330	6.2 (13.7)	5.4 (11.9)	
		8.9 (350)	28 - 32	350	6.7 (14.7)	5.8 (12.8)	
10.2 (400)	28 - 33	390	7.6 (16.8)	6.6 (14.6)			

⁽¹⁾Typical all weld metal. ⁽²⁾Measured with 0.2% offset. ⁽³⁾See test results disclaimer ⁽⁴⁾To estimate ESO, subtract 1/4 in. (6.0 mm) from CTWD.

ULTRACORE® HD-12C

Mild Steel, All Position · AWS E71T-12C-JH8, E71T-1C-JH8, E71T-9C-JH8

KEY FEATURES

- Increase weld deposition to more than 14 lbs/hr out-of-position
- Fast freezing slag for a flat bead shape and increased productivity in all positions
- Operators can set the machine on a single setting and weld in all positions
- Weld over light rust, mill scale, and primer
- Capable of exceeding 27 J (20 ft-lbf) at -40°C (-40°F)
- ProTech® foil bag packaging

WELDING POSITIONS

All

SHIELDING GAS

100% CO₂
Flow Rate: 40 - 50 CFH

CONFORMANCES

AWS A5.20:	E71T-12C-JH8, E71T-1C-JH8, E71T-9C-JH8
ABS:	3YSA H10
CWB/CSA W48:	E491T1-C1A4-CS2-H8 [E491T-9J-H8]
DNV - 2.9:	III YMS H10
Lloyd's Register:	3YS H10
ISO 17632-B:	T49 4 T12-1 C1 A-K H10

TYPICAL APPLICATIONS

- Heavy Fabrication
- Mining
- General Fabrication
- Structural
- Applications requiring PWHT of mild steels

DIAMETERS / PACKAGING

Diameter in (mm)	15 lb (6.8 kg) Plastic Spool 60 lb (27.2 kg) Master Carton	33 lb (15 kg) Fiber Spool
0.045 (1.1)	ED035631	ED034274
0.052 (1.3)	ED035632	ED034275
1/16 (1.6)	ED036295	ED034276

MECHANICAL PROPERTIES⁽¹⁾

	Yield Strength ⁽²⁾ MPa (ksi)	Tensile Strength MPa (ksi)	Elongation %	Charpy V-Notch J (ft-lbf)	
				@ -29°C (-20°F)	@ -40°C (-40°F)
Requirements⁽⁴⁾ AWS A5.20: E71T-12C-JH8	400 (58) min	480-620 (70-90)	22 min	-	27 (20) min
Typical Results⁽³⁾ As-Welded with 100% CO ₂ Stress-Relieved for 1 hr @ 620°C (1150°F)	538 (78) 496 (72)	593 (86) 579 (84)	28 28	93 (68) 58 (43)	51 (38) -

DEPOSIT COMPOSITION⁽¹⁾

	%C	%Mn	%Si	%Ni
Requirements⁽⁴⁾ AWS A5.20: E71T-12C-JH8	0.12 max	1.60 max	0.90 max	0.50 max
Typical Results⁽³⁾ As-Welded with 100% CO ₂	0.04	1.35	0.33	0.40
	%S	%P	Diffusible Hydrogen (mL/100g weld deposit)	
Requirements⁽⁴⁾ AWS A5.20: E71T-12C-JH8	0.03 max	0.03 max	8.0 max	
Typical Results⁽³⁾ As-Welded with 100% CO ₂	0.01	0.01	4-7	

⁽¹⁾Typical all weld metal. ⁽²⁾Measured with 0.2% offset. ⁽³⁾See test results disclaimer. ⁽⁴⁾As-Welded with 100% CO₂.

TYPICAL OPERATING PROCEDURES

Diameter, Polarity Shielding Gas	CTWD ⁽²⁾ mm (in)	Wire Feed Speed m/min (in/min)	Voltage (volts)	Approx. Current (amps)	Melt-Off Rate kg/hr (lb/hr)	Deposition Rate kg/hr (lb/hr)	Efficiency (%)
0.045 in (1.1 mm), DC+ As-Welded with 100% CO ₂	25 (1)	4.4 (175)	24-29	115	1.8 (3.9)	1.5 (3.4)	85-88
		6.4 (250)	25-30	140	2.5 (5.6)	2.2 (4.8)	
		7.6 (300)	26-31	155	3.1 (6.8)	2.6 (5.8)	
		8.9 (350)	26-31	170	3.6 (7.9)	3.1 (6.8)	
		10.2 (400)	26-31	185	4.1 (9.0)(10.1)	3.5 (7.8)	
		11.4 (450)	27-32	200	4.6 (11.3)	4.0 (8.8)	
		12.7 (500)	27-32	215	5.1 (12.4)	4.4 (9.8)	
		14.0 (550)	28-33	230	5.6 (13.5)	4.9 (10.8)	
15.2 (600)	28-33	245	6.1	5.3 (11.7)			
0.052 in (1.3 mm), DC+ As-Welded with 100% CO ₂	25 (1)	3.8	24-29	140	2.1 (4.7)	1.7 (3.8)	85-88
		5.1 (150)	25-30	160	2.9 (6.3)	2.4 (5.2)	
		6.4 (200)	26-31	180	3.5 (7.8)	3.0 (6.5)	
		7.6 (250)	26-31	205	4.3 (9.4)	3.6 (7.9)	
		8.9 (300)	27-32	225	5.0 (11.0)	4.2 (9.2)	
		9.5 (350)	27-32	235	5.3 (11.7)	4.5 (9.9)	
		10.8 (375)(425)	27-32	255	6.0 (13.3)	5.1 (11.2)	
		12.1 (475)(500)	28-33	275	6.8 (14.9)	5.7 (12.6)	
12.7	28-33	290	7.1 (15.6)	6.0 (13.3)			
1/16 in (1.6 mm), DC+ As-Welded with 100% CO ₂	25 (1)	3.8	23-28	200	2.9 (6.4)	2.4 (5.3)	85-88
		4.4	24-29	215	3.4 (7.5)	2.9 (6.3)	
		5.1 (150)(175)	24-29	230	3.9 (8.5)	3.3 (7.2)	
		5.7 (200)(225)	24-29	245	4.4 (9.6)	3.7 (8.1)	
		6.4 (250)(300)	25-30	255	4.8 (10.6)	4.1 (9.1)	
		7.6 (325)(350)	25-30	285	5.8 (12.7)	4.9 (10.9)	
		8.3 (400)	26-31	300	6.3 (13.8)	5.4 (11.9)	
		8.9	26-31	310	6.7 (14.8)	5.8 (12.8)	
		10.2	27-32	340	7.7 (16.9)	6.7 (14.7)	

⁽¹⁾Typical all weld metal. ⁽²⁾Measured with 0.2% offset. ⁽³⁾See test results disclaimer ⁽⁴⁾As-Welded with 100% CO₂. ⁽⁵⁾To estimate ESO, subtract 1/4 in (6.0 mm) from CTWD.

ULTRACORE® HD-12M

Mild Steel, All Position · AWS E71T-12M-JH8, E71T-1M-JH8, E71T-9M-JH8

KEY FEATURES

- Increase weld deposition up to 14 lbs/hr out-of-position
- Results in a flat bead shape and enhanced productivity in all positions
- Operators can set the machine on a single setting and weld in all positions
- Capable of exceeding 27 J (20 ft-lbf) at -40°C (-40°F)
- ProTech® foil bag packaging

CONFORMANCES

AWS A5.20:	E71T-12M-JH8, E71T-1M-JH8, E71T-9M-JH8
ABS:	3Y400SA H10 3YSA H10
CWB/CSA W48:	E491T1-M21A4-CS2-H8 [E491T-12MJ-H8]
DNV - 2.9:	III YMS H10
Lloyd's Register:	3YS H10
ISO 17632-B:	T49 4 T12-1 M21 A-K H10

WELDING POSITIONS

All

SHIELDING GAS

75-80% Argon / Balance CO₂
Flow Rate: 40 - 50 CFH

TYPICAL APPLICATIONS

- Heavy Fabrication
- Mining
- General Fabrication

DIAMETERS / PACKAGING

Diameter in (mm)	15 lb (6.8 kg) Plastic Spool 60 lb (27.2 kg) Master Carton	33 lb (15 kg) Fiber Spool
0.045 (1.1)	ED036180	ED034277
0.052 (1.3)	ED036181	ED034278
1/16 (1.6)	ED036294	ED034279

MECHANICAL PROPERTIES⁽¹⁾

	Yield Strength ⁽²⁾ MPa (ksi)	Tensile Strength MPa (ksi)	Elongation %	Charpy V-Notch J (ft-lbf)	
				@ -29°C (-20°F)	@ -40°C (-40°F)
Requirements⁽⁴⁾ AWS A5.20: E71T-12M-JH8	400 (58) min	480-620 (70-90)	22 min	-	27 (20) min
Typical Results⁽³⁾ As-Welded with 75% Argon / 25% CO ₂ Stress Relieved for 1 hr @ 620°C (1150°F)	538 (78) 503 (73)	600 (87) 593 (86)	26 29	102 (75) 68 (50)	65 (48) -

⁽¹⁾Typical all weld metal. ⁽²⁾Measured with 0.2% offset. ⁽³⁾See test results disclaimer ⁽⁴⁾As-Welded with 75-80% Ar / Balance CO₂.

DEPOSIT COMPOSITION⁽¹⁾

	%C	%Mn	%Si	%Ni
Requirements⁽⁴⁾ AWS A5.20: E71T-12M-JH8	0.12 max	1.60 max	0.90 max	0.50 max
Typical Results⁽³⁾ As-Welded with 75% Argon / 25% CO ₂	0.05	1.40	0.39	0.40
	%S	%P	Diffusible Hydrogen (mL/100g weld deposit)	
Requirements⁽⁴⁾ AWS A5.20: E71T-12M-JH8	0.03 max	0.03 max	8.0 max	
Typical Results⁽³⁾ As-Welded with 75% Argon / 25% CO ₂	0.01	0.01	4-7	

TYPICAL OPERATING PROCEDURES

Diameter, Polarity Shielding Gas	CTWD ⁽²⁾ mm (in)	Wire Feed Speed m/min (in/min)	Voltage (volts)	Approx. Current (amps)	Melt-Off Rate		Deposition Rate		Efficiency (%)
					kg/hr	(lb/hr)	kg/hr	(lb/hr)	
0.045 in (1.1 mm), DC+ As-Welded with 75% Ar/25% CO ₂	25 (1)	4.4 (175)	23-28	115	1.8 (3.9)	1.5 (3.4)	85-88		
		6.4 (250)	24-29	140	2.5 (5.6)	2.2 (4.8)			
		7.6 (300)	25-30	155	3.1 (6.8)	2.6 (5.8)			
		8.9 (350)	25-30	170	3.6 (7.9)	3.1 (6.8)			
		10.2 (400)	25-30	185	4.1 (9.0)	3.5 (7.8)			
		11.4 (450)	26-31	200	4.6 (10.1)	4.0 (8.8)			
		12.7 (500)	26-31	215	5.1 (11.3)	4.4 (9.8)			
		14.0 (550)	27-32	230	5.6 (12.4)	4.9 (10.8)			
15.2 (600)	27-32	245	6.1 (13.5)	5.3 (11.7)					
0.052 in (1.3 mm), DC+ As-Welded with 75% Ar/25% CO ₂	25 (1)	3.8 (150)	23-28	140	2.1 (4.7)	1.7 (3.8)	85-88		
		5.1 (200)	24-29	160	2.9 (6.3)	2.4 (5.2)			
		6.4 (250)	25-30	180	3.5 (7.8)	3.0 (6.5)			
		7.6 (300)	25-30	205	4.3 (9.4)	3.6 (7.9)			
		8.9 (350)	26-31	225	5.0 (11.0)	4.2 (9.2)			
		9.5 (375)	26-31	235	5.3 (11.7)	4.5 (9.9)			
		10.8 (425)	26-31	255	6.0 (13.3)	5.1 (11.1)			
		12.1 (475)	27-32	275	6.8 (14.9)	5.7 (12.6)			
12.7 (500)	27-32	290	7.1 (15.6)	6.0 (13.3)					
1/16 in (1.6 mm), DC+ As-Welded with 75% Ar/25% CO ₂	25 (1)	3.8 (150)	22-27	200	2.9 (6.4)	2.4 (5.3)	85-88		
		4.4 (175)	23-28	215	3.4 (7.5)	2.9 (6.3)			
		5.1 (200)	23-28	230	3.9 (8.5)	3.3 (7.2)			
		5.7 (225)	23-28	245	4.4 (9.6)	3.7 (8.1)			
		6.4 (250)	24-29	255	4.8 (10.6)	4.1 (9.1)			
		7.6 (300)	24-29	285	5.8 (12.7)	4.9 (10.9)			
		8.3 (325)	25-30	300	6.3 (13.8)	5.4 (11.9)			
		8.9 (350)	25-30	310	6.7 (14.8)	5.8 (12.8)			
10.2 (400)	26-31	340	7.7 (16.9)	6.7 (14.7)					

⁽¹⁾Typical all weld metal. ⁽²⁾Measured with 0.2% offset. ⁽³⁾See test results disclaimer ⁽⁴⁾As-Welded with 75-80% Ar / Balance CO₂. ⁽⁵⁾To estimate ESO, subtract 1/4 in (6.0 mm) from CTWD.

ULTRACORE® HD MARINE

Mild Steel, All Positions · AWS E71T-1C-H8, E71T-9C-H8

KEY FEATURES

- Excellent operator appeal with minimal spatter and low fume generation rates
- High deposition rates up to 12 lbs/hr out-of-position
- Fast freezing slag for a flat bead shape and increased productivity
- Weld in all positions with one setting
- ProTech® foil bag packaging

CONFORMANCES

AWS A5.20:	E71T-1C-H8, E71T-9C-H8
ABS:	2Y400SA H10 2YSA H10
DNV - 2.9:	II YMS H10
Lloyd's Register:	2YS H10
BV:	SAZY H10

WELDING POSITIONS

All

TYPICAL APPLICATIONS

- Shipbuilding
- General Fabrication

SHIELDING GAS

100% CO₂
Flow rate: 40-50 CFH

DIAMETERS / PACKAGING

Diameter in (mm)	15 lb (6.8 kg) Plastic Spool 60 lb (27.2 kg) Master Carton	33 lb (15 kg) Fiber Spool
0.052 (1.3)	ED035743	ED036323
1/16 (1.6)	ED035778	ED036324

MECHANICAL PROPERTIES⁽¹⁾

	Yield Strength ⁽²⁾ MPa (ksi)	Tensile Strength MPa (ksi)	Elongation (%)	Charpy V-Notch J (ft-lbf)	
				@-18°C (0°F)	@-29°C (-20°F)
Requirements AWS A5.20: E71T-1C-H8, E71T-9C-H8	400 (58) min	480-655 (70-95)	22 min	27 (20) min	27 (20) min
Typical Results⁽³⁾ As-Welded with 100% CO ₂	580-615 (84-89)	630-655 (92-95)	27	87-96 (64-71)	49-58 (36-43)

⁽¹⁾ Typical all weld metal. ⁽²⁾ Measured with 0.2% offset. ⁽³⁾ See test results disclaimer

DEPOSIT COMPOSITION⁽¹⁾

	%C	%Mn	%Si	%S
Requirements AWS A5.20: E71T-1C-H8,E71T-9C-H8	0.12 max	1.75 max	0.90 max	0.03 max
Typical Results⁽²⁾ As-Welded with 100% CO ₂	0.04-0.05	1.59-1.70	0.36-0.40	0.01
	%P	%Ni	Diffusible Hydrogen (ml/100g weld deposit)	
Requirements AWS A5.20: E71T-1C-H8,E71T-9C-H8	0.03 max	0.50 max	8.0 max	
Typical Results⁽²⁾ As-Welded with 100% CO ₂	0.016	0.02	3.1-4.1	

TYPICAL OPERATING PROCEDURES

Diameter, Polarity Shielding Gas	CTWD ⁽⁴⁾ mm (in)	Wire Feed Speed m/min (in/min)	Voltage (Volts)	Approx. Current (amps)	Melt-Off Rate kg/hr (lb/hr)	Deposition Rate kg/hr (lb/hr)	Efficiency (%)
0.052 in (1.3mm), DC+, 100% CO ₂	19-25 (3/4-1)	3.8 (150)	22-25	140	2.0 (4.5)	1.7 (3.7)	81-85
		5.1 (200)	23-26	175	2.6 (5.8)	2.2 (4.9)	
		6.4 (250)	23-27	210	3.4 (7.4)	2.8 (6.2)	
		7.6 (300)	24-29	230	4.0 (8.8)	3.4 (7.4)	
		8.9 (350)	26-30	255	4.6 (10.2)	3.9 (8.7)	
		9.5 (375)	27-30	275	5.0 (11.1)	4.3 (9.4)	
		10.2 (400)	29-31	280	5.4 (11.9)	4.5 (9.9)	
		12.1 (475)	29-33	295	6.5 (14.3)	5.5 (12.2)	
1/16 in (1.6mm), DC+, 100% CO ₂	19-25 (3/4-1)	3.8 (150)	23-26	185	2.9 (6.3)	2.4 (5.3)	83-87
		4.4 (175)	23-27	220	3.3 (7.3)	2.8 (6.1)	
		5.1 (200)	23-27	240	3.8 (8.3)	3.2 (7.1)	
		5.7 (225)	23-28	260	4.2 (9.2)	3.7 (8.2)	
		6.4 (250)	24-29	275	4.7 (10.4)	4.3 (9.4)	
		7.6 (300)	25-30	315	5.6 (12.4)	4.8 (10.6)	
		8.3 (325)	27-31	325	6.1 (13.5)	5.3 (11.7)	
		8.9 (350)	27-31	335	6.7 (14.7)	5.8 (12.7)	
9.5 (400)	28-32	360	7.7 (16.9)	6.6 (14.5)			

⁽¹⁾Typical all weld metal. ⁽²⁾Measured with 0.2% offset. ⁽³⁾See test results disclaimer ⁽⁴⁾To estimate ESO, subtract 1/4 in (6.0 mm) from CTWD.

OUTERSHIELD® 71M

Mild Steel, All Position · AWS E71T-1C-J, E71T-1C-JH16, E71T-1M-J, E71T-1M-JH16, E71T-9C-J, E71T-9C-JH16, E71T-9M-J

KEY FEATURES

- Dual classified for both 100% CO₂ and 75% Argon / 25% CO₂ mixed gas
- Exceeds impact requirements at -40°C [-40°F]
- High travel speeds
- Spray like transfer with minimal spatter
- Rod based manufacturing for industry leading wire stiffness and feedability
- Increased rigidity allows for easy manual break-off

SHIELDING GAS

100% CO₂
75% Argon / 25% CO₂
Flow Rate: 40 - 50 CFH

WELDING POSITIONS

All, except vertical down

DIAMETERS / PACKAGING

Diameter in (mm)	10 lb (4.5 kg) Plastic Spool	25 lb (11.3 kg) Plastic Spool	33 lb (15 kg) Steel Spool	50 lb (22.7 kg) Coil
0.035 (0.9)	ED026804	ED026805		
0.045 (1.1)	ED020836	ED022659	ED030007	ED020844
0.052 (1.3)		ED022660	ED030008	ED020845
1/16 (1.6)		ED022661	ED030009	ED020846
Diameter in (mm)	300 lb (136 kg) Speed-Feed® Reel	500 lb (227 kg) Accu-Trak® Drum	600 lb (272 kg) Speed-Feed® Reel	
0.035 (0.9)				
0.045 (1.1)		ED027364		
0.052 (1.3)		ED029778		
1/16 (1.6)	ED020848	ED029779		ED020851

MECHANICAL PROPERTIES⁽¹⁾

	Yield Strength ⁽²⁾ MPa (ksi)	Tensile Strength MPa (ksi)	Elongation %	Charpy V-Notch J (ft-lbf)		
				@ -18°C [0°F]	@ -29°C [-20°F]	@ -40°C [-40°F]
Requirements AWS A5.20 E71T-1C-J / E71T-1M-J AWS A5.20 E71T-9C-J / E71T-9M-J	400 [58] min	480-655 [70-95]	22 min	27 [20] min -	- 27 [20] min	27 [20] min ^(a) 27 [20] min ^(a)
Test Results⁽³⁾ As-Welded with 100% CO ₂ and 75% Argon/25% CO ₂	500-570 [72-83]	560-630 [81-91]	27-29	176-190 [130-140]	176-190 [130-140]	130-163 [96-120]

^(a)Electrodes with the optional supplemental designator "J" shall meet the minimum Charpy V-Notch impact energy requirement for its classification at a test temperature of 10°C lower than the test temperature for its classification.

CONFORMANCES

AWS A5.20:	E71T-1C-J, E71T-1C-JH16, E71T-1M-J, E71T-1M-JH16, E71T-9C-J, E71T-9C-JH16, E71T-9M-J
ABS:	3YSA, 3YSA H15
CWB/CSA W48:	E491T1-C1A4-CS1-H16, E491T1-M21A4-CS1-H16, E491T-9J-H16, E491T-9MJ-H16
DNV - 2.9:	III YMS H10
Lloyd's Register:	3YS H15
BV:	SA3YH
ISO 17632-B:	T49 4 T1-1, C1 A H15, T49 4 T1-1, M21 A H15
MIL-E-24403/1D:	MIL-71T-1C, MIL-71T-1M

TYPICAL APPLICATIONS

- Bridge, ship, & barge
- General fabrication
- Machinery fabrication
- Structural fabrication
- Offshore applications

DEPOSIT COMPOSITION⁽¹⁾

	%C	%Mn	%Si	%S	%P
Requirements AWS A5.20 E71T-1C-J / E71T-1M-J AWS A5.20 E71T-9C-J / E71T-9M-J	0.12 max	1.75 max	0.90 max	0.03 max	0.03 max
Test Results⁽²⁾ As-Welded with 100% CO ₂ and 75% Argon/25% CO ₂	0.05-0.07	1.04-1.60	0.25-0.50	≤ 0.01	< 0.01

TYPICAL OPERATING PROCEDURES

Diameter, Polarity Shielding Gas ⁽⁴⁾	CTWD ⁽³⁾ mm [in]	Wire Feed Speed m/min [in/min]	Voltage [volts]	Approx. Current [amps]	Melt-Off Rate kg/hr [lb/hr]	Deposition Rate kg/hr [lb/hr]	Efficiency [%]
0.035 in (0.9 mm), DC+ 100% CO ₂	19-25 (3/4-1)	5.1 [200]	20-23	95	1.3 [2.8]	1.1 [2.8]	85
		6.4 [250]	21-24	115	1.6 [3.5]	1.4 [3.5]	85
		7.6 [300]	22-25	130	1.9 [4.2]	1.6 [4.2]	86
		8.9 [350]	23-26	150	2.2 [4.9]	1.9 [4.9]	86
		10.2 [400]	24-27	160	2.6 [5.6]	2.2 [5.6]	86
		12.7 [500]	26-29	185	3.2 [7.0]	2.7 [7.0]	86
		15.2 [600]	28-31	200	3.8 [8.4]	3.3 [8.4]	86
		17.8 [700]	30-33	215	4.4 [9.8]	3.8 [9.8]	86
0.045 in (1.1 mm), DC+ 100% CO ₂	19-25 (3/4-1)	5.1 [200]	23-26	165	2.1 [4.6]	1.8 [3.9]	83
		6.4 [250]	24-27	190	2.6 [5.8]	2.2 [4.8]	84
		7.6 [300]	25-28	220	3.1 [6.9]	2.6 [5.8]	84
		8.9 [350]	26-29	245	3.7 [8.1]	3.1 [6.8]	84
		10.2 [400]	26-29	265	4.2 [9.2]	3.5 [7.8]	84
		12.7 [500]	28-31	295	5.2 [11.5]	4.4 [9.7]	84
		15.2 [600]	30-33	315	6.3 [13.8]	5.3 [11.7]	85
		17.8 [700]	32-35	325	7.3 [16.1]	6.2 [13.7]	85
0.052 in (1.3 mm), DC+ 100% CO ₂	19-25 (3/4-1)	3.8 [150]	22-25	150	2.1 [4.7]	1.7 [3.8]	81
		5.1 [200]	23-26	180	2.8 [6.2]	2.3 [5.1]	83
		6.4 [250]	24-27	210	3.5 [7.7]	2.9 [6.5]	83
		7.6 [300]	25-28	235	4.2 [9.3]	3.5 [7.8]	84
		8.9 [350]	27-30	265	4.9 [10.8]	4.2 [9.1]	84
		11.4 [450]	29-32	305	6.3 [13.9]	5.4 [11.8]	85
		12.7 [500]	30-33	325	7.0 [15.5]	6.0 [13.2]	85
		15.2 [600]	33-36	360	8.4 [18.6]	7.2 [15.8]	85
1/16 in (1.6 mm), DC+ 100% CO ₂	19 (3/4)	3.2 [125]	23-26	205	2.5 [5.4]	2.0 [4.5]	82
		3.8 [150]	24-27	225	3.0 [6.5]	2.4 [5.4]	82
		5.1 [200]	25-28	260	4.0 [8.7]	3.3 [7.2]	83
		6.4 [250]	26-29	295	4.9 [10.9]	4.1 [9.1]	83
		7.6 [300]	28-31	330	5.9 [13.0]	5.0 [10.9]	84
	25 (1)	10.2 [400]	30-33	395	7.9 [17.4]	6.6 [14.6]	84
		12.7 [500]	33-36	445	9.9 [21.7]	8.3 [18.3]	84

⁽¹⁾Typical all weld metal. ⁽²⁾Measured with 0.2% offset. ⁽³⁾See test results disclaimer. ⁽⁴⁾When welding under mixed gas, decrease voltage. ⁽⁵⁾To estimate ESO, subtract 1/4 in (6.0 mm) from CTWD.
NOTE: This product contains micro-alloying elements.

OUTERSHIELD® 71 ELITE

Mild Steel, All Position · AWS E71T-1C-H8, E71T-1M-H8, E71T-9C-H8, E71T-9M-H8

KEY FEATURES

- Smooth arc transfer and low spatter
- Designed for welding with either 100% CO₂ or 75-82% Argon/balance CO₂ shielding gases
- Good bead appearance
- Fast freezing slag for out-of-position welding
- Meets AWS D1.8 seismic lot waiver requirements

CONFORMANCES

AWS A5.20:	E71T-1C-H8, E71T-1M-H8, E71T-9C-H8, E71T-9M-H8
ABS:	3YSA H10
CWB/CSA W48:	E491T-9-H8, E491T-9M-H8
DNV - 2.9:	III YMS H10
Lloyd's Register:	3YS H10
AWS D1.8:	0.052", 1/16"

WELDING POSITIONS

All

SHIELDING GAS

100% CO₂
 75 - 82% Argon / Balance CO₂
 Flow Rate: 40 - 50 CFH

TYPICAL APPLICATIONS

- Shipbuilding, barges and offshore platforms
- Heavy equipment
- Structural fabrication
- General fabrication

DIAMETERS / PACKAGING

Diameter in (mm)	15 lb (6.8 kg) Plastic Spool 60 lb (27.2 kg) Master Carton	33 lb (15 kg) Steel Spool	60 lb (27.2 kg) Coil	600 lb (272 kg) Accu-Trak® Drum
0.045 (1.1)	ED029418	ED029201	ED029202	
0.052 (1.3)	ED029419	ED029204	ED029205	
1/16 (1.6)		ED029206	ED029207	ED029387

MECHANICAL PROPERTIES⁽¹⁾

	Yield Strength ⁽²⁾ MPa (ksi)	Tensile Strength MPa (ksi)	Elongation %	Charpy V-Notch J (ft-lbf)	
				@ -18°C (0°F)	@ -29°C (-20°F)
Requirements AWS A5.20 E71T-1C-H8, E71T-9C-H8 AWS A5.20 E71T-1M-H8, E71T-9M-H8	400 (58) min	485-655 (70-95)	22 min	27 (20) min —	— 27 (20) min
Typical Results⁽³⁾ As-Welded with 100% CO ₂ As-Welded with 75% Ar/25% CO ₂	545-565 (79-82) 585-595 (85-87)	585-615 (85-90) 625-630 (91-92)	28 25-28	74-83 (55-61) 92-99 (68-73)	58-64 (43-47) 70-83 (52-61)

DEPOSIT COMPOSITION⁽¹⁾

	%C	%Mn	%Si	%S	%P
Requirements AWS A5.20 E71T-1C-H8, E71T-9C-H8 AWS A5.20 E71T-1M-H8, E71T-9M-H8	0.12 max	1.75 max	0.90 max	0.03 max	0.03 max
Typical Results⁽³⁾ As-Welded with 100% CO ₂ As-Welded with 75% Ar/25% CO ₂	0.01-0.04 0.02-0.04	1.41-1.50 1.55-1.65	0.44-0.60 0.56-0.75	≤0.01 ≤0.01	≤0.01 ≤0.01

TYPICAL OPERATING PROCEDURES

Diameter, Polarity Shielding Gas ⁽⁴⁾	CTWD ⁽⁵⁾ mm (in)	Wire Feed Speed m/min (in/min)	Voltage (volts)	Approx. Current (amps)	Melt-Off Rate kg/hr (lb/hr)	Deposition Rate kg/hr (lb/hr)	Efficiency [%]
0.045 in (1.1 mm), DC+ 75% Ar / 25% CO ₂	19 (3/4)	4.5 (175)	21-24	130	1.7 (3.8)	1.5 (3.3)	87
		6.4 (250)	23-26	155	2.4 (5.4)	2.1 (4.7)	87
		7.6 (300)	24-27	180	2.9 (6.4)	2.5 (5.6)	87
		8.9 (350)	25-28	205	3.4 (7.6)	3.0 (6.6)	87
		10.2 (400)	26-29	230	4.0 (8.7)	3.5 (7.6)	87
		12.8 (500)	27-30	260	5.0 (10.9)	4.3 (9.5)	87
		15.3 (600)	28-31	290	6.0 (13.1)	5.2 (11.4)	87
0.052 in (1.3 mm), DC+ 75% Ar / 25% CO ₂	19 (3/4)	3.8 (150)	21-24	150	2.1 (4.6)	1.8 (3.9)	86
		5.1 (200)	22-25	180	2.8 (6.1)	2.4 (5.2)	86
		6.4 (250)	23-26	210	3.4 (7.6)	3.0 (6.5)	86
		7.6 (300)	24-27	240	4.8 (10.6)	4.1 (7.8)	86
		10.2 (400)	26-28	315	6.2 (13.7)	5.4 (10.5)	86
		12.8 (500)	28-31	335	6.9 (15.2)	6.0 (13.1)	86
1/16 (1.6 mm), DC+ 75% Ar / 25% CO ₂	19 (3/4)	3.2 (125)	21-24	190	2.4 (5.2)	2.0 (4.4)	85
		3.8 (150)	22-25	205	2.8 (6.2)	2.4 (5.3)	85
		5.1 (200)	22-26	240	3.8 (8.3)	3.2 (7.0)	85
		6.4 (250)	23-27	290	4.7 (10.3)	4.0 (8.8)	85
		7.6 (300)	24-28	325	5.6 (12.4)	4.8 (10.5)	85
		10.2 (400)	27-31	400	7.5 (16.5)	6.4 (14.0)	85

⁽¹⁾Typical all weld metal. ⁽²⁾Measured with 0.2% offset. ⁽³⁾See test results disclaimer ⁽⁴⁾When welding under CO₂, increase voltage by 1 Volt. ⁽⁵⁾To estimate ESO, subtract 1/4 in (6.0 mm) from CTWD.

OUTERSHIELD® 71 SUPREME

Mild Steel, All Position · AWS E71T-1C-H4, E71T-9C-H4, E71T-1M-H4, E71T-9M-H4

KEY FEATURES

- Designed to be used with either 100% CO₂ or 75% Argon/25% CO₂ gas
- Smooth, consistent arc performance
- The finished weld exhibits an extremely smooth bead appearance, even on out-of-position welds
- Meets H4 diffusible hydrogen levels

WELDING POSITIONS

All

SHIELDING GAS

75% Argon/25% CO₂
 100% CO₂
 Flow Rate: 40 - 50 CFH

CONFORMANCES

- AWS A5.20:** E71T-1C-H4, E71T-1M-H4, E71T-9C-H4, E71T-9M-H4
- CSA W48:** E491T1-C1A3-CS1-H4 [E491T-9-H4], E491T1-M21A3-CS1-H4 [E491T-9M-H4]

TYPICAL APPLICATIONS

- Mining
- Offshore
- Bridge fabrication
- High strength fabrication
- Structural steel

NOTE

- This product is only sold in Canada.
- This product contains micro-alloying elements.
- Additional information available upon request.

DIAMETERS / PACKAGING

Diameter in. mm	33 lb (15 kg) Spool	500 lb (227 kg) Accu-Trak® Drum	600 lb (272 kg) Accu-Trak® Drum
0.045 (1.1)	ED503040	ED503046*	
0.052 (1.3)	ED503041	ED503047*	
1/16 (1.6)	ED503042		ED503048*

*Made to order (MTO)

MECHANICAL PROPERTIES⁽¹⁾

	Yield Strength ⁽²⁾ MPa (ksi)	Tensile Strength MPa (ksi)	Elongation %	Charpy V-Notch J (ft·lbf) @ -29°C [-20°F]
Requirements CWB W48 E491T-9-H4, E491T-9M-H4	400 (58) min	485-655 (70-95)	22 min	27 (20) min
Typical Results⁽³⁾ As-Welded with 100% CO ₂ As-Welded with 75% Ar/25% CO ₂	520-593 (75-86) 560-646 (81-94)	580-640 (84-93) 510-699 (88-101)	26-28 25-28	49-98 (36-72) 102-126 (75-93)

DEPOSIT COMPOSITION⁽¹⁾ – As Required per CSA W48.06

	%C	%Mn	%Si	%S	%P	%Ni
Requirements CWB W48 E491T-9-H4, E491T-9M-H4	0.18 max	1.75 max	0.09 max	0.03 max	0.03 max	0.50 max
Test Results⁽²⁾ As-Welded with 100% CO ₂	0.04-0.05	1.29-1.43	0.43-0.49	0.01	0.01	0.02-0.03
As-Welded with 75%Ar/25% CO ₂	0.03-0.05	1.45-1.64	0.54-0.68	0.01	0.01	0.02-0.03
	%Cr	%Mo	%V	%Cu	Diffusible Hydrogen (ml/100g weld deposit)	
Requirements CWB W48 E491T-9-H4, E491T-9M-H4	0.20 max	0.30 max	0.08 max	0.35 max	4.0 max	
Test Results⁽²⁾ As-Welded with 100% CO ₂	0.04-0.05	0.02-0.03	0.03	0.04-0.10	3-4	
As-Welded with 75%Ar/25% CO ₂	0.04-0.05	0.02	0.03-0.04	0.04-0.08	3-4	

TYPICAL OPERATING PROCEDURES – All Position

Diameter, Polarity Shielding Gas ⁽⁴⁾	CTWD ⁽³⁾ mm (in)	Wire Feed Speed m/min (in/min)	Voltage (volts)	Approx. Current (amps)	Melt-Off Rate kg/hr (lb/hr)	Deposition Rate kg/hr (lb/hr)	Efficiency [%]
0.045 in (1.1 mm), DC+ 75% Ar / 25% CO ₂	25 (1)	4.4-12.7 (175-500)	22-28	125-260	2.0-5.2 (4.5-11.3)	1.8-4.6 (4.0-10.05)	86-88
0.052 in (1.3 mm), DC+ 75% Ar / 25% CO ₂	25 (1)	3.8-10.2 (150-400)	22-31	135-295	2.1-5.4 (4.6-12.0)	1.8-4.9 (4.0-10.07)	86-88
1/16 (1.6 mm), DC+ 75% Ar / 25% CO ₂	25 (1)	3.8-8.9 (150-350)	23-31	135-365	2.9-6.7 (6.4-14.7)	2.5-5.9 (5.6-13.1)	86-88

⁽¹⁾Typical all weld metal. ⁽²⁾Measured with 0.2% offset. ⁽³⁾See test results disclaimer. ⁽⁴⁾When welding under CO₂, increase voltage by 1 Volt. ⁽⁵⁾To estimate ESD, subtract 1/4 in (6.0 mm) from CTWD.

ULTRACORE® 70C

Mild Steel, Flat & Horizontal · AWS E70T-1C-H8, E70T-9C-H8

KEY FEATURES

- High deposition in the flat and horizontal positions
- Low fume generation rates
- Designed for welding with 100% CO₂ shielding gas
- Premium arc performance and bead appearance
- ProTech® foil bag packaging

WELDING POSITIONS

Flat & Horizontal

SHIELDING GAS

100% CO₂
Flow Rate: 40-55 CFH

CONFORMANCES

AWS A5.20:	E70T-1C-H8, E70T-9C-H8
ABS:	2YSA H10
CWB/CSA W48:	E490T1-C1A3-CS1-H8 (E492T-9-H8)
AWS D1.8:	1/16", 5/64", 3/32"
ISO 17632-B:	T49 3 T1-0 C1 A H10

TYPICAL APPLICATIONS

- Structural fabrication
- Heavy equipment
- Shipbuilding

DIAMETERS / PACKAGING

Diameter in (mm)	50 lb (22.7 kg) Coil	500 lb (227 kg) Accu-Trak® Drum	500 lb (227 kg) Speed-Feed® Drum
1/16 (1.6)	ED032978	ED033064	
5/64 (2.0)	ED032977		ED033065
3/32 (2.4)	ED032941		ED033066

MECHANICAL PROPERTIES⁽¹⁾

	Yield Strength ⁽²⁾ MPa (ksi)	Tensile Strength MPa (ksi)	Elongation %	Charpy V-Notch J (ft-lbf)	
				@ -18°C (0°F)	@ -29°C (-20°F)
Requirements⁽⁴⁾ AWS A5.20 E70T-1C-H8, E70T-9C-H8	400 (58) min	480-655 (70-95)	22 min	27 (20) min	27 (20) min
Typical Results⁽³⁾ As-Welded with 100% CO ₂	485-520 (70-75)	555-590 (81-86)	28-30	47-72 (35-53)	28-47 (21-35)

⁽¹⁾Typical all weld metal. ⁽²⁾Measured with 0.2% offset. ⁽³⁾See test results disclaimer ⁽⁴⁾As-Welded with 100% CO₂.

DEPOSIT COMPOSITION⁽¹⁾

	%C	%Mn	%Si	%S	%P	Diffusible Hydrogen (mL/100g weld deposit)
Requirements⁽⁴⁾ AWS A5.20 E70T-1C-H8, E70T-9C-H8	0.12 max	1.75 max	0.90 max	0.03 max	0.03 max	8.0 max
Typical Results⁽³⁾ As-Welded with 100% CO ₂	0.04-0.05	1.46-1.59	0.54-0.59	≤ 0.01	≤ 0.01	5-8

TYPICAL OPERATING PROCEDURES – Flat & Horizontal

Diameter, Polarity Shielding Gas	CTWD ⁽³⁾ mm (in)	Wire Feed Speed m/min (in/min)	Voltage (volts)	Approx. Current (amps)	Melt-Off Rate kg/hr (lb/hr)	Deposition Rate kg/hr (lb/hr)	Efficiency (%)
1/16 in (1.6 mm), DC+ 100% CO ₂	25 (1)	3.2 (125)	23-27	170	2.4 (5.3)	2.1 (4.7)	84 - 89
		5.1 (200)	24-28	225	3.8 (8.4)	3.2 (7.1)	
		6.4 (250)	25-30	260	4.8 (10.5)	4.1 (9.0)	
		7.6 (300)	27-31	280	5.7 (12.6)	4.9 (10.8)	
		9.5 (375)	28-32	320	7.1 (15.7)	6.1 (13.5)	
5/64 in (2.0 mm), DC+ 100% CO ₂	25 (1)	3.2 (125)	23-27	230	3.8 (8.4)	3.2 (7.1)	84 - 88
		4.4 (175)	24-29	305	5.4 (11.8)	4.6 (10.1)	
		5.7 (225)	25-30	365	6.8 (15.0)	5.9 (13.0)	
		6.4 (250)	26-32	385	7.7 (16.9)	6.5 (14.3)	
		7.6 (300)	27-33	420	9.0 (19.8)	7.8 (17.2)	
3/32 in (2.4 mm), DC+ 100% CO ₂	25 (1)	3.2 (125)	26-33	350	5.4 (11.9)	4.7 (10.3)	87 - 89
		5.1 (200)	27-34	500	8.6 (19.0)	7.6 (16.7)	
	31 (1 1/4)	6.4 (250)	29-35	570	10.6 (23.3)	9.4 (20.8)	
		7.6 (300)	31-37	630	13.1 (28.8)	11.4 (25.1)	
		8.3 (325)	32-38	720	14.3 (31.5)	12.4 (27.2)	

⁽¹⁾Typical all weld metal. ⁽²⁾Measured with 0.2% offset. ⁽³⁾See test results disclaimer ⁽⁴⁾As-Welded with 100% CO₂. ⁽⁵⁾To estimate ESO, subtract 1/4 in (6.0 mm) from CTWD.

ULTRACORE® 75C

Mild Steel, Flat & Horizontal · AWS E70T-5C-JH4

KEY FEATURES

- Basic slag system offers improved crack resistance and impact properties compared to rutile products
- High deposition in the flat and horizontal positions
- H4 diffusible hydrogen levels
- Designed for welding with 100% CO₂ shielding gas
- Premium arc performance and bead appearance
- ProTech® foil bag packaging

WELDING POSITIONS

Flat & Horizontal

SHIELDING GAS

100% CO₂

Flow Rate: 40-55 CFH

CONFORMANCES

AWS A5.20: E70T-5C-JH4

CWB/CSA W48: E490T5-C1A4-CS1-H4 [E492T-5J-H4]

ISO 17632-B: T49 4 T5-0 C1 A H5

TYPICAL APPLICATIONS

- Highly restrained joints
- Heaving equipment
- Mining
- Hard to weld base metals
- Thick steel sections in structural fabrication

DIAMETERS / PACKAGING

Diameter in (mm)	50 lb (22.7 kg) Coil
1/16 (1.6)	ED032974
5/64 (2.0)	ED032975
3/32 (2.4)	ED032940

MECHANICAL PROPERTIES⁽¹⁾

	Yield Strength ⁽²⁾ MPa (ksi)	Tensile Strength MPa (ksi)	Elongation %	Charpy V-Notch J (ft-lbf)	
				@ -29°C [-20°F]	@ -40°C [-40°F]
Requirements⁽⁴⁾ - AWS A5.20 E70T-5C-JH4	400 [58] min	480-655 [70-95]	22 min	27 [20] min	27 [20] min
Typical Results⁽³⁾ As-Welded with 100% CO ₂	465-510 [68-74]	545-580 [79-84]	29-32	91-142 [67-105]	53-113 [39-83]

DEPOSIT COMPOSITION⁽¹⁾

	%C	%Mn	%Si	%S	%P	Diffusible Hydrogen (mL/100g weld deposit)
Requirements⁽⁴⁾ - AWS A5.20 E70T-5C-JH4	0.12 max	1.75 max	0.90 max	0.03 max	0.03 max	4.0 max
Typical Results⁽³⁾ As-Welded with 100% CO ₂	0.06-0.08	1.51-1.66	0.44-0.53	0.01	0.01	2-4

TYPICAL OPERATING PROCEDURES – Flat & Horizontal

Diameter, Polarity Shielding Gas	CTWD ⁽⁵⁾ mm (in)	Wire Feed Speed m/min (in/min)	Voltage (volts)	Approx. Current (amps)	Melt-Off Rate kg/hr (lb/hr)	Deposition Rate kg/hr (lb/hr)	Efficiency (%)
1/16 in (1.6 mm), DC+ 100% CO ₂	19-25 (3/4-1)	5.1 (200)	29-34	230	4.0 (8.7)	3.1 (6.9)	76-86
		6.4 (250)	31-36	270	5.0 (11.0)	3.8 (8.5)	
		7.6 (300)	32-37	295	5.9 (13.1)	4.5 (10.0)	
		8.9 (350)	33-38	335	6.9 (15.2)	5.5 (12.1)	
		10.2 (400)	33-38	360	7.9 (17.4)	6.3 (13.9)	
		12.7 (500)	35-40	415	9.9 (21.8)	7.9 (17.5)	
5/64 in (2.0 mm), DC+ 100% CO ₂	25-32 (1-1 1/4)	5.1 (200)	29-34	295	5.7 (12.7)	4.8 (10.5)	82-86
		6.4 (250)	30-35	345	7.2 (15.9)	6.0 (13.2)	
		7.6 (300)	32-37	390	8.6 (19.0)	7.1 (15.6)	
		8.9 (350)	33-38	425	10.1 (22.3)	8.5 (18.7)	
		10.2 (400)	34-39	465	11.5 (25.3)	9.9 (21.8)	
3/32 in (2.4 mm), DC+ 100% CO ₂	32 (1-3/8)	3.2 (125)	23-28	335	5.5 (12.2)	4.8 (10.7)	87-90
		5.1 (200)	27-32	445	8.8 (19.3)	7.6 (16.7)	
		6.4 (250)	29-34	500	10.9 (24.1)	9.6 (21.3)	
		7.6 (300)	31-36	590	13.2 (29.2)	11.8 (26.0)	
		8.3 (325)	32-37	605	14.2 (31.4)	12.8 (28.3)	

⁽¹⁾Typical all weld metal. ⁽²⁾Measured with 0.2% offset. ⁽³⁾See test results disclaimer ⁽⁴⁾As-Welded with 100% CO₂. ⁽⁵⁾To estimate ESO, subtract 1/4 in (6.0 mm) from CTWD.

ULTRACORE® XP70

Mild Steel, Flat & Horizontal · AWS E70T-1C-H8, E70T-9C-H8

KEY FEATURES

- High deposition in the flat and horizontal positions
- Low spatter generation
- Good weld bead wetting
- Excellent slag detachability, even in deep or narrow grooves
- Wide operating range for great operator appeal across all skill levels

WELDING POSITIONS

Flat & Horizontal

CONFORMANCES

AWS A5.20: E70T-1C-H8, E70T-9C-H8

AWS D1.8: 1/16", 5/64", 3/32"

TYPICAL APPLICATIONS

- Structural fabrication
- Heavy equipment

SHIELDING GAS

100% CO₂
Flow Rate: 40-55 CFH

DIAMETERS / PACKAGING

Diameter in (mm)	50 lb (22.7 kg) Coil	500 lb (227 kg) Accu-Trak® Drum	500 lb (227 kg) Speed-Feed® Drum
1/16 [1.6]	ED036431	ED036547	
5/64 [2.0]	ED036430		ED036642
3/32 [2.4]	ED036427		ED036515

MECHANICAL PROPERTIES⁽¹⁾

	Yield Strength ⁽²⁾ MPa (ksi)	Tensile Strength MPa (ksi)	Elongation %	Charpy V-Notch J (ft·lbf)	
				@ -18°C (0°F)	@ -29°C (-20°F)
Requirements⁽⁴⁾ AWS A5.20: E70T-1C-H8, E70T-9C-H8	400 [58] min	480-655 [70-95]	22 min	27 [20] min	27 [20] min
Typical Results⁽³⁾ As-Welded with 100% CO ₂	495-555 [72-81]	570-625 [82-91]	25-29	35-59 [26-44]	27-59 [20-44]

DEPOSIT COMPOSITION⁽¹⁾

	%C	%Mn	%Si	%S	%P	%B	Diffusible Hydrogen (mL/100g weld deposit)
Requirements⁽⁴⁾ AWS A5.20 E70T-1C-H8, E70T-9C-H8	0.12 max	1.75 max	0.90 max	0.03 max	0.03 max	Not Specified	8.0 max
Typical Results⁽³⁾ As-Welded with 100% CO ₂	0.03 - 0.06	1.44 - 1.64	0.49 - 0.56	≤ 0.008	<0.016	<0.0042	2-4

TYPICAL OPERATING PROCEDURES – Flat & Horizontal

Diameter, Polarity Shielding Gas	CTWD ⁽⁵⁾ mm (in)	Wire Feed Speed		Voltage (volts)	Approx. Current (amps)	Melt-Off Rate		Deposition Rate		Efficiency (%)
		m/min	(in/min)			kg/hr	(lb/hr)	kg/hr	(lb/hr)	
1/16 in (1.6 mm), DC+ 100% CO ₂	19 (3/4)	3.2	(125)	26-30	165	2.4	(5.2)	2.1	(4.6)	87 - 90
		5.1	(200)	27-31	255	3.8	(8.3)	3.4	(7.4)	
6.4		(250)	27-31	300	4.8	(10.4)	4.2	(9.3)		
25 (1)	7.6	(300)	28-32	300	5.7	(12.5)	5.1	(11.2)		
	9.5	(375)	28-32	315	7.1	(15.6)	6.4	(14.1)		
5/64 in (2.0 mm), DC+ 100% CO ₂	25 (1)	3.2	(125)	27-31	260	3.8	(8.3)	3.3	(7.2)	
		4.4	(175)	27-31	330	5.3	(11.7)	4.7	(10.4)	
		5.7	(225)	27-31	390	6.8	(15.0)	6.1	(13.5)	
		6.4	(250)	28-32	420	7.6	(16.7)	6.8	(15.1)	
		7.0	(275)	28-32	450	8.3	(18.4)	7.6	(16.7)	
		8.3	(325)	28-32	475	9.1	(20.0)	8.3	(18.2)	
3/32 in (2.4 mm), DC+ 100% CO ₂	25 (1)	3.2	(125)	28-32	360	5.4	(12.0)	4.9	(10.9)	88 - 91
		5.1	(200)	28-32	490	8.7	(19.2)	7.8	(17.1)	
6.4		(250)	29-33	575	10.9	(24.0)	9.7	(21.3)		
32 (1 1/4)	7.0	(275)	29-33	450	12.0	(26.5)	10.6	(23.4)		
	7.6	(300)	30-34	575	13.1	(28.9)	11.5	(25.4)		
	8.3	(325)	31-35	615	14.2	(31.3)	12.5	(27.5)		

⁽¹⁾ Typical all weld metal. ⁽²⁾ Measured with 0.2% offset. ⁽³⁾ See test results disclaimer. ⁽⁴⁾ As-Welded with 100% CO₂. ⁽⁵⁾ To estimate ESQ, subtract 1/4 in (6.0 mm) from CTWD.

OUTERSHIELD® XLH-70

Mild Steel, Flat & Horizontal · AWS E70T-9C-H8, E70T1-C1A2-CS1-H8

KEY FEATURES

- Meets AWS D1.8 seismic lot waiver requirements for demand critical welds
- H8 diffusible hydrogen levels - controlled for high resistance to hydrogen induced cracking.
- High deposition rates and excellent fast follow characteristics
- Stiff wire enables feeding over long distances
- Tolerates mild levels of surface contaminants
- Designed for welding with CO₂ shielding gas
- ProTech® foil bag packaging

WELDING POSITIONS

Flat & Horizontal

CONFORMANCES

AWS A5.20:	E70T1-C1A2-CS1-H8, E70T-1C-H8, E70T-9C-H8
ABS:	3YSA H5
AWS D1.8:	3/32"

TYPICAL APPLICATIONS

- Structural fabrication
- General fabrication
- Machinery fabrication
- Heavy equipment
- Seismic applications

SHIELDING GAS

100% CO₂
Flow Rate: 40-55 CFH

DIAMETERS / PACKAGING

Diameter in (mm)	50 lb (22.7 kg) Coil	500 lb (227 kg) Speed-Feed® Drum
3/32 (2.4)	ED030236	ED030360

NOTE: Speed-Feed® drums require rotation for proper payoff.

MECHANICAL PROPERTIES⁽¹⁾

	Yield Strength ⁽²⁾ MPa (ksi)	Tensile Strength MPa (ksi)	Elongation %	Charpy V-Notch J (ft-lbf)	
				@ -18°C (0°F)	@ -29°C (-20°F)
Requirements AWS A5.20 E70T-1C-H8 AWS A5.20 E70T-9C-H8	400 (58) min	480-660 (70-95)	22 min	27 (20) min –	– 27 (20) min
Typical Results⁽³⁾ As-Welded with 100% CO ₂	480-530 (70-77)	570-620 (82-89)	27-30	61-134 (45-99)	42-107 (31-79)

DEPOSIT COMPOSITION⁽¹⁾

	%C	%Mn	%Si
Requirements - AWS A5.20 E70T-1C-H8, E70T-9C-H8	0.12 max	1.75 max	0.90 max
Test Results⁽²⁾ As-Welded with 100% CO ₂	0.06-0.07	1.40-1.60	0.48-0.58
	%S	%P	Diffusible Hydrogen (mL/100g weld deposit)
Requirements - AWS A5.20 E70T-1C-H8, E70T-9C-H8	0.03 max	0.03 max	8.0 max
Test Results⁽²⁾ As-Welded with 100% CO ₂	≤0.01	≤0.01	3-6

TYPICAL OPERATING PROCEDURES

Diameter, Polarity Shielding Gas	CTWD ⁽⁴⁾ mm (in)	Wire Feed Speed m/min (in/min)	Voltage (volts)	Approx. Current (amps)	Melt-Off Rate kg/hr (lb/hr)	Deposition Rate kg/hr (lb/hr)	Efficiency (%)
3/32 in. (2.4 mm), DC+ 100% CO ₂	32 (1-1/4)	3.8 (150)	23-26	345	6.5 (14.4)	5.6 (12.4)	86
		5.1 (200)	27-30	445	8.7 (19.2)	7.6 (16.8)	87
		6.4 (250)	28-31	510	10.9 (24.0)	9.5 (21.0)	87
		7.6 (300)	30-32	570	13.1 (28.8)	11.4 (25.2)	87
		8.3 (325)	31-33	600	14.2 (31.2)	12.4 (27.3)	87

⁽¹⁾Typical all weld metal. ⁽²⁾Measured with 0.2% offset. ⁽³⁾See test results disclaimer ⁽⁴⁾To estimate ESO, subtract 1/4 in [6.0 mm] from CTWD.

ULTRACORE® 81Ni1A75-H

Low Alloy, All Position · AWS E81T1-Ni1M-JH4



KEY FEATURES

- Capable of producing weld deposits with impact toughness exceeding 88 - 123 J (65 - 91 ft-lbf) at -40°C [-40°F]
- Designed for welding with 75-85% Argon/ balance CO₂ shielding gas
- Premium arc performance and bead appearance
- Meets AWS D1.8 seismic lot waiver requirements
- ProTech® foil bag packaging
- Color match on weathering steel

CONFORMANCES

- AWS A5.29:** E81T1-Ni1M-JH4
- ABS:** 4YQ460SA H5
- CWB/CSA W48:** E551T1-M21A4-Ni1M-H4 (E551T1-Ni1M-JH4)
- DNV - 2.9:** IV Y46MS H5
- Lloyd's Register:** 4Y46S H5
- AWS D1.8:** 0.045", 0.052", 1/16"
- ISO 17632-B:** T55 4 T1-1 M21 A-N2 H5

WELDING POSITIONS

All

SHIELDING GAS

75% - 85% Argon / Balance CO₂
Flow Rate: 40-50 CFH

TYPICAL APPLICATIONS

- Bridge fabrication
- Weathering steels
- Offshore
- Structural fabrication
- NACE applications

DIAMETERS / PACKAGING

Diameter in (mm)	33 lb (15 kg) Spool**	500 lb (227 kg) Accu-Trak® Drum
0.045 (1.1)	ED032206, ED034411*	ED034412*
0.052 (1.3)	ED032279	
1/16 (1.6)	ED032207, ED034413*	

*Buy America Product **Spool may be plastic or fiber.

MECHANICAL PROPERTIES⁽¹⁾

	Yield Strength ⁽²⁾ MPa (ksi)	Tensile Strength MPa (ksi)	Elongation %	Charpy V-Notch J [ft-lbf]	
				@ -29°C [-20°F]	@ -40°C [-40°F]
Requirements⁽⁴⁾ - AWS A5.29 E81T1-Ni1M-JH4	470 [68] min	550-690 [80-100]	19 min	27 [20] min	27 [20] min
Typical Results⁽³⁾ AS-Welded with 75% Ar/25% CO ₂	545-595 [79-86]	595-640 [86-93]	24-28	107-142 [79-105]	88-123 [65-91]

DEPOSIT COMPOSITION⁽¹⁾

	%C	%Mn	%Si	%S	%P	%Ni
Requirements⁽⁴⁾ - AWS A5.29 E81T1-Ni1M-JH4	0.12 max	1.50 max	0.80 max	0.030 max	0.030 max	0.80-1.10
Typical Results⁽³⁾ As-Welded with 75% Ar/25% CO ₂	0.04-0.05	1.26-1.36	0.25-0.29	0.006-0.009	0.005-0.008	0.86-0.96
	%Mo	%Cr	%V	%B	Diffusible Hydrogen (mL/100g weld deposit)	
Requirements⁽⁴⁾ - AWS A5.29 E81T1-Ni1M-JH4	0.35 max	0.15 max	0.05 max	Not Specified	4.0 max	
Typical Results⁽³⁾ As-Welded with 75% Ar/25% CO ₂	0.01	0.04-0.05	0.02-0.03	0.005-0.007	2-4	

TYPICAL OPERATING PROCEDURES

Diameter, Polarity Shielding Gas	CTWD ⁽⁵⁾ mm (in)	Wire Feed Speed m/min (in/min)	Voltage (volts)	Approx. Current (amps)	Melt-Off Rate kg/hr (lb/hr)	Deposition Rate kg/hr (lb/hr)	Efficiency [%]
0.045 in (1.1 mm), DC+ 75%-85% Ar/ balance CO ₂	25 (1)	4.4 (175)	22-27	140	1.8 (4.0)	1.6 (3.5)	86-88
		5.1 (200)	23-28	150	2.1 (4.6)	1.8 (4.0)	
		6.4 (250)	24-29	165	2.6 (5.7)	2.3 (5.0)	
		7.6 (300)	24-29	190	3.1 (6.8)	2.7 (6.0)	
		8.9 (350)	25-30	205	3.6 (8.0)	3.2 (7.0)	
		9.5 (375)	25-30	225	3.9 (8.6)	3.4 (7.5)	
		10.8 (425)	26-31	245	4.4 (9.7)	3.8 (8.5)	
		12.1 (475)	27-32	265	4.9 (10.8)	4.3 (9.5)	
0.052 in (1.3 mm), DC+ 75%-85% Ar/ balance CO ₂	25 (1)	3.8 (150)	22-27	150	2.0 (4.5)	1.8 (3.9)	86-88
		4.7 (185)	23-28	165	2.5 (5.5)	2.2 (4.8)	
		5.7 (225)	23-28	190	3.1 (6.7)	2.7 (5.9)	
		6.4 (250)	24-29	215	3.4 (7.5)	2.9 (6.5)	
		7.0 (275)	24-29	235	3.7 (8.2)	3.2 (7.2)	
		7.6 (300)	25-30	265	4.1 (9.0)	3.5 (7.8)	
		8.5 (335)	25-31	275	4.5 (10.0)	4.0 (8.7)	
		9.5 (375)	26-32	295	5.1 (11.2)	4.4 (9.8)	
1/16 in (1.6 mm), DC+ 75%-85% Ar/ balance CO ₂	25 (1)	3.8 (150)	22-27	200	2.9 (6.3)	2.5 (5.5)	86-88
		4.4 (175)	23-28	210	3.3 (7.4)	2.9 (6.4)	
		5.1 (200)	24-29	235	3.8 (8.4)	3.3 (7.3)	
		5.7 (225)	24-29	265	4.3 (9.5)	3.7 (8.2)	
		6.5 (250)	25-30	285	4.8 (10.5)	4.2 (9.2)	
		7.0 (275)	25-31	315	5.3 (11.6)	4.6 (10.1)	
		8.3 (325)	26-32	335	6.2 (13.7)	5.4 (11.9)	
		8.9 (350)	27-33	365	6.7 (14.7)	5.8 (12.8)	

⁽¹⁾Typical all weld metal. ⁽²⁾Measured with 0.2% offset. ⁽³⁾See test results disclaimer. ⁽⁴⁾As-Welded with 75% Argon / 25% CO₂. ⁽⁵⁾To estimate ESO, subtract 1/4 in (6.0 mm) from CTWD.
NOTE 1: FEMA and AWS D1.8 structural steel seismic supplement test data can be found on this product at www.lincolnelectric.com. NOTE 2: This product contains micro-alloying elements. Additional information available upon request.

ULTRACORE® 81Ni1C-H

Low Alloy, All Position · AWS E81T1-Ni1C-JH4

KEY FEATURES

- Capable of producing weld deposits with impact toughness exceeding 84 - 130 J (62 - 96 ft-lbf) at -40°C [-40°F]
- Designed for welding with 100% CO₂ shielding gas
- Premium arc performance and bead appearance
- Meets AWS D1.8 seismic lot waiver requirements
- ProTech® foil bag packaging
- Color match on weathering steels

CONFORMANCES

- AWS A5.29:** E81T1-Ni1C-JH4
- ABS:** 4YQ460SA H5
- CWB/CSA W48:** E551T1-C1A4-Ni1-H4 (E551T1-Ni1C-JH4)
- DNV - 2.9:** IV Y46MS H5
- Lloyd's Register:** 4Y46S H5
- AWS D1.8:** 0.045", 0.052", 1/16"
- ISO 17632-B:** T55 4 T1-1 C1 A-N2- H5

WELDING POSITIONS

All

SHIELDING GAS

100% CO₂
Flow Rate: 40-50 CFH

TYPICAL APPLICATIONS

- Bridge fabrication
- Weathering steels
- Offshore
- Structural fabrication
- NACE applications

DIAMETERS / PACKAGING

Diameter in (mm)	33 lb (15 kg) Spool**	50 lb (22.7 kg) Fiber Spool
0.045 (1.1)	ED032204, ED034414*	ED032745, ED034416*
0.052 (1.3)	ED032280, ED034415*	
1/16 (1.6)	ED032205	

*Buy America Product **Spool may be plastic or fiber.

MECHANICAL PROPERTIES⁽¹⁾

	Yield Strength ⁽²⁾ MPa (ksi)	Tensile Strength MPa (ksi)	Elongation %	Charpy V-Notch J (ft-lbf)	
				@ -29°C [-20°F]	@ -40°C [-40°F]
Requirements⁽⁴⁾ - AWS A5.29 E81T1-Ni1C-JH4	470 (68) min	550-690 (80-100)	19 min	27 [20] min	27 [20] min
Typical Results⁽³⁾ As-Welded with 100% CO ₂	540-585 (78-84)	595-635 (86-91)	25-28	111-152 (82-112)	84-130 (62-96)

DEPOSIT COMPOSITION⁽¹⁾

	%C	%Mn	%Si	%S	%P	%Ni
Requirements⁽⁴⁾ - AWS A5.29 E81T1-NiC-JH4	0.12 max	1.50 max	0.80 max	0.030 max	0.030 max	0.80-1.10
Typical Results⁽³⁾ As-Welded with 100% CO ₂	0.04-0.05	1.24-1.34	0.27-0.31	0.006-0.007	0.007-0.009	0.88-0.99
	%Mo	%Cr	%V	%B	Diffusible Hydrogen (mL/100g weld deposit)	
Requirements⁽⁴⁾ - AWS A5.29 E81T1-NiC-JH4	0.35 max	0.15 max	0.05 max	Not Specified	4.0 max	
Typical Results⁽³⁾ As-Welded with 100% CO ₂	0.01	0.04-0.05	0.02-0.03	0.005-0.006	3-4	

TYPICAL OPERATING PROCEDURES

Diameter, Polarity Shielding Gas	CTWD ⁽²⁾ mm (in)	Wire Feed Speed m/min (in/min)	Voltage (volts)	Approx. Current (amps)	Melt-Off Rate kg/hr (lb/hr)	Deposition Rate kg/hr (lb/hr)	Efficiency (%)
0.045 in (1.1 mm), DC+ 100% CO ₂	25 (1)	4.4 (175)	23-28	140	1.8 (4.0)	1.6 (3.5)	86-88
		5.1 (200)	24-29	150	2.1 (4.6)	1.8 (4.0)	
		6.4 (250)	25-30	165	2.6 (5.7)	2.3 (5.0)	
		7.6 (300)	25-30	190	3.1 (6.8)	2.7 (6.0)	
		8.9 (350)	26-31	205	3.6 (8.0)	3.2 (7.0)	
		9.5 (375)	26-31	225	3.9 (8.6)	3.4 (7.5)	
		10.8 (425)	27-32	245	4.4 (9.7)	3.8 (8.5)	
		12.1 (475)	28-33	265	4.9 (10.8)	4.3 (9.5)	
0.052 in (1.3 mm), DC+ 100% CO ₂	25 (1)	3.8 (150)	23-28	150	2.0 (4.5)	1.8 (3.9)	86-88
		4.7 (185)	24-29	165	2.5 (5.5)	2.2 (4.8)	
		5.7 (225)	24-29	190	3.1 (6.7)	2.7 (5.9)	
		6.4 (250)	25-30	215	3.4 (7.5)	2.9 (6.5)	
		7.0 (275)	25-30	235	3.7 (8.2)	3.2 (7.2)	
		7.6 (300)	26-31	255	4.1 (9.0)	3.5 (7.8)	
		8.5 (335)	26-31	275	4.5 (10.0)	4.0 (8.7)	
		9.5 (375)	27-32	295	5.1 (11.2)	4.4 (9.8)	
1/16 in (1.6 mm), DC+ 100% CO ₂	25 (1)	3.8 (150)	24-29	200	2.9 (6.3)	2.5 (5.5)	86-88
		4.4 (175)	24-30	210	3.3 (7.4)	2.9 (6.4)	
		5.1 (200)	25-30	235	3.8 (8.4)	3.3 (7.3)	
		5.7 (225)	25-31	265	4.3 (9.5)	3.7 (8.2)	
		6.4 (250)	26-31	285	4.8 (10.5)	4.2 (9.2)	
		7.0 (275)	26-32	305	5.3 (11.6)	4.6 (10.1)	
		8.3 (325)	27-32	335	6.2 (13.7)	5.4 (11.9)	
		8.9 (350)	28-34	365	6.7 (14.7)	5.8 (12.8)	

⁽¹⁾Typical all weld metal. ⁽²⁾Measured with 0.2% offset. ⁽³⁾See test results disclaimer ⁽⁴⁾As-Welded with 100% CO₂. ⁽⁵⁾To estimate ESO, subtract 1/4 in (6.0 mm) from CTWD.
NOTE 1: FEMA and AWS D1.8 structural steel seismic supplement test data can be found on this product at www.lincolnelectric.com. NOTE 2: This product contains micro-alloying elements.
Additional information available upon request.

ULTRACORE® 81Ni1C-H PLUS

Low Alloy, All Positions • AWS E81T1-Ni1C-JH4

KEY FEATURES

- Innovative design capable of superior toughness at -60°F in both the as-welded and stress-relieved conditions
- Designed for welding with 100% CO₂ shielding gas
- H4 diffusible hydrogen levels
- Q2 Lot® - Certificate showing actual deposit chemistry and mechanical properties per lot available online
- ProTech® foil bag packaging
- Designed to accommodate applications requiring Nickel content of 1% max
- Color match on weathering steels

WELDING POSITIONS

All

SHIELDING GAS

100% CO₂
Flow Rate: 40-50 CFH

CONFORMANCES

- AWS A5.29:** E81T1-Ni1C-JH4
ABS: 4YQ460SA H5
CWB/CSA W48: E551T1-C1A5-Ni1-H4 (E551T1-Ni1C-JH4)
DNV - 2.9: IV Y46MS H5
Lloyd's Register: 4Y46S H5
AWS D1.8: 0.045", 0.052", 1/16"

TYPICAL APPLICATIONS

- Offshore drilling rigs
- Low temperature storage tanks
- Ship building
- Construction
- Mining Equipment

DIAMETERS / PACKAGING

Diameter in (mm)	33 lb (15kg) Plastic Spool
0.045 (1.1)	ED034858
0.052 (1.3)	ED034859
1/16 (1.6)	ED034860

MECHANICAL PROPERTIES⁽¹⁾

	Yield Strength ⁽²⁾ MPa (ksi)	Tensile Strength MPa (ksi)	Elongation (%)	Charpy V-Notch J (ft-lbf)	
				-40°C (-40°F)	-51°C (-60°F)
Requirements AWS A5.29: E81T1-Ni1C-JH4 As-Welded with 100% CO ₂	470 (68) min	550-690 (80-100)	19 min	27 (20) min	-
Typical Results⁽³⁾ As-Welded with 100% CO ₂	505-565 (73-82)	585-640 (85-93)	23-29	87-127 (54-94)	41-123 (30-91)
Stress Relieved with 100% CO ₂ for 1 hr @ 621°C (1150°F)	475-530 (69-77)	560-620 (81-90)	26-30	41-108 (30-80)	-

⁽¹⁾ Typical all weld metal. ⁽²⁾ Measure with 0.2% offset. ⁽³⁾ See test results disclaimer

DEPOSIT COMPOSITION⁽¹⁾

	%C	%Mn	%Si	%S	%P	%Ni
Requirements AWS A5.29: E81T1-Ni1C-JH4	0.12 max	1.50 max	0.80 max	0.030 max	0.030 max	0.80-1.10
Typical Results⁽²⁾ with 100% CO ₂	0.04-0.05	1.29-1.37	0.42-0.45	0.007-0.008	0.011	0.89-0.95
	%Cr	%Mo	%V	%B	Diffusible Hydrogen (mL/100g weld deposit)	
Requirements AWS A5.29: E81T1-Ni1C-JH4	0.15 max	0.35 max	0.05 max	Not Specified	4.0 max	
Typical Results⁽²⁾ with 100% CO ₂	0.05	0.10	0.00	0.004-0.005	2-4	

TYPICAL OPERATING PROCEDURES

Diameter, Polarity Shielding Gas	CTWD ⁽⁴⁾ mm (in)	Wire Feed Speed m/min (in/min)	Voltage (volts)	Approx. Current (amps)	Melt-Off Rate kg/hr (lb/hr)	Deposition Rate kg/hr (lb/hr)	Efficiency (%)
0.045 in (1.1 mm), DC+	19 (3/4)	4.4 (175)	25 - 29	120	1.8 (3.9)	1.5 (3.4)	85-87
	19 (3/4)	6.4 (250)	26 - 30	140	2.5 (5.6)	2.2 (4.8)	
	19 (3/4)	7.6 (300)	27 - 31	155	3.1 (6.8)	2.6 (5.8)	
	19 (3/4)	8.9 (350)	28 - 32	170	3.6 (7.9)	3.1 (6.8)	
	25 (1)	10.2 (400)	29 - 33	185	4.1 (9.0)	3.5 (7.8)	
	25 (1)	11.4 (450)	29 - 33	200	4.6 (10.1)	4.0 (8.8)	
0.052 in (1.3 mm), DC+	19 (3/4)	3.8 (150)	25 - 29	150	2.1 (4.7)	1.7 (3.8)	81-84
	19 (3/4)	5.1 (200)	26 - 30	170	2.9 (6.3)	2.4 (5.2)	
	19 (3/4)	6.4 (250)	27 - 31	195	3.5 (7.8)	3.0 (6.5)	
	25 (1)	7.6 (300)	28 - 32	215	4.3 (9.4)	3.6 (7.9)	
	25 (1)	8.9 (350)	29 - 33	240	5.0 (11.0)	4.2 (9.2)	
1/16 in (1.6 mm), DC+	19 (3/4)	3.8 (150)	26 - 30	190	2.9 (6.4)	2.4 (5.3)	83-87
	19 (3/4)	4.4 (175)	26 - 30	205	3.4 (7.5)	2.9 (6.3)	
	19 (3/4)	5.1 (200)	27 - 31	220	3.9 (8.5)	3.3 (7.2)	
	19 (3/4)	5.7 (225)	27 - 31	230	4.4 (9.6)	3.7 (8.1)	
	19 (3/4)	6.4 (250)	28 - 32	245	4.8 (10.6)	4.1 (9.1)	
	25 (1)	7.6 (300)	28 - 32	275	5.8 (12.7)	4.9 (10.9)	
	25 (1)	8.3 (325)	29 - 33	290	6.3 (13.8)	5.4 (11.9)	
	25 (1)	8.9 (350)	29 - 33	300	6.7 (14.8)	5.8 (12.8)	

⁽¹⁾ Typical all weld metal. ⁽²⁾ Measure with 0.2% offset. ⁽³⁾ See test results disclaimer ⁽⁴⁾ To estimate ESO, subtract 1/4 in (6.0 mm) from CTWD.

ULTRACORE[®] 81Ni1M-H PLUS

Low Alloy, All Positions • AWS E81T1-Ni1M-JH4

KEY FEATURES

- Innovative design capable of superior toughness at -60°F in both the as-welded and stress-relieved conditions
- Designed for welding with 75-80% Argon/ Balance CO₂ shielding gas
- H4 diffusible hydrogen levels
- Q2 Lot[®] - Certificate showing actual deposit chemistry and mechanical properties per lot available online
- ProTech[®] foil bag packaging
- Designed to accommodate applications requiring Nickel content of 1% max
- Color match on weathering steels

WELDING POSITIONS

All

SHIELDING GAS

75-80% Argon / Balance CO₂
Flow Rate: 40-50 CFH

CONFORMANCES

- AWS A5.29:** E81T1-Ni1M-JH4
ABS: 4YQ460SA H5
CWB/CSA W48: E551T1-M21A5-Ni1-H4 (E551T1-Ni1M-JH4)
DNV - 2.9: IV Y46MS H5
Lloyd's Register: 4Y46S H5
AWS D1.8: 0.045", 1/16"

TYPICAL APPLICATIONS

- Offshore drilling rigs
- Low temperature storage tanks
- Ship building
- Construction
- Mining Equipment

DIAMETERS / PACKAGING

Diameter in (mm)	33 lb (15kg) Plastic Spool
0.045 (1.1)	ED034855
0.052 (1.3)	ED034856
1/16 (1.6)	ED034857

MECHANICAL PROPERTIES⁽¹⁾

	Yield Strength ⁽²⁾ MPa (ksi)	Tensile Strength MPa (ksi)	Elongation (%)	Charpy V-Notch J (ft-lbf)	
				-40°C (-40°F)	-51°C (-60°F)
Requirements AWS A5.29: E81T1-Ni1M-JH4 As-Welded with 75% Ar / 25% CO ₂	470 (68) min	550-690 (80-100)	19 min	27 (20) min	-
Typical Results⁽³⁾ As-Welded with 75% Ar / 25% CO ₂	505-530 (73-77)	582-605 (84-88)	26-28	92-104 (68-77)	80-89 (59-66)
Stress Relieved with 75% Ar / 25% CO ₂ for 1 hr @ 621°C (1150°F)	475-493 (69-71)	575-588 (83-85)	27-29	80-96 (59-71)	-

⁽¹⁾ Typical all weld metal. ⁽²⁾ Measure with 0.2% offset. ⁽³⁾ See test results disclaimer

DEPOSIT COMPOSITION⁽¹⁾

	%C	%Mn	%Si	%S	%P	%Ni
Requirements AWS A5.29: E81T1-Ni1M-JH4	0.12 max	1.50 max	0.80 max	0.030 max	0.030 max	0.80-1.10
Typical Results⁽²⁾ with 75% Argon / 25% CO ₂	0.05-0.06	1.31-1.38	0.41-0.44	0.007	0.012	0.83-0.87
	%Cr	%Mo	%V	%B	Diffusible Hydrogen (mL/100g weld deposit)	
Requirements AWS A5.29: E81T1-Ni1M-JH4	0.15 max	0.35 max	0.05 max	Not Specified	4.0 max	
Typical Results⁽³⁾ with 75% Argon / 25% CO ₂	0.05	0.01	0.00	0.005-0.006	2-4	

TYPICAL OPERATING PROCEDURES

Diameter, Polarity Shielding Gas	CTWD ⁽⁴⁾ mm (in)	Wire Feed Speed m/min (in/min)	Voltage [volts]	Approx. Current [amps]	Melt-Off Rate kg/hr (lb/hr)	Deposition Rate kg/hr (lb/hr)	Efficiency [%]
0.045 in (1.1 mm), DC+	19 (3/4)	4.4 (175)	24 - 28	120	1.8 (3.9)	1.5 (3.4)	85-87
	19 (3/4)	6.4 (250)	25 - 29	140	2.5 (5.6)	2.2 (4.8)	
	19 (3/4)	7.6 (300)	26 - 30	155	3.1 (6.8)	2.6 (5.8)	
	19 (3/4)	8.9 (350)	27 - 31	170	3.6 (7.9)	3.1 (6.8)	
	25 (1)	10.2 (400)	28 - 32	185	4.1 (9.0)	3.5 (7.8)	
	25 (1)	11.4 (450)	28 - 32	200	4.6 (10.1)	4.0 (8.8)	
	25 (1)	12.7 (500)	29 - 33	220	5.1 (11.3)	4.4 (9.8)	
0.052 in (1.3 mm), DC+	19 (3/4)	3.8 (150)	24 - 28	150	2.1 (4.7)	1.7 (3.8)	81-84
	19 (3/4)	5.1 (200)	25 - 29	170	2.9 (6.3)	2.4 (5.2)	
	19 (3/4)	6.4 (250)	26 - 30	195	3.5 (7.8)	3.0 (6.5)	
	25 (1)	7.6 (300)	27 - 31	215	4.3 (9.4)	3.6 (7.9)	
	25 (1)	8.9 (350)	28 - 32	240	5.0 (11.0)	4.2 (9.2)	
1/16 in (1.6 mm), DC+	19 (3/4)	3.8 (150)	25 - 29	190	2.9 (6.4)	2.4 (5.3)	83-87
	19 (3/4)	4.4 (175)	25 - 29	205	3.4 (7.5)	2.9 (6.3)	
	19 (3/4)	5.1 (200)	26 - 30	220	3.9 (8.5)	3.3 (7.2)	
	19 (3/4)	5.7 (225)	26 - 30	230	4.4 (9.6)	3.7 (8.1)	
	19 (3/4)	6.4 (250)	27 - 31	245	4.8 (10.6)	4.1 (9.1)	
	25 (1)	7.6 (300)	27 - 31	275	5.8 (12.7)	4.9 (10.9)	
	25 (1)	8.3 (325)	28 - 32	290	6.3 (13.8)	5.4 (11.9)	
25 (1)	8.9 (350)	28 - 32	300	6.7 (14.8)	5.8 (12.8)		

⁽¹⁾ Typical all weld metal. ⁽²⁾ Measure with 0.2% offset. ⁽³⁾ See test results disclaimer ⁽⁴⁾ To estimate ESO, subtract 1/4 in (6.0 mm) from CTWD.

ULTRACORE® 81Ni2A75-H

Low Alloy, All Position · AWS E81T1-Ni2M-JH4

KEY FEATURES

- Capable of producing weld deposits with impact toughness exceeding 41 - 89 J [30 - 66 ft-lbf] at -51°C [-60°F]
- Designed for welding with 75-85% Argon/ Balance CO₂ shielding gas
- Premium arc performance and bead appearance
- H4 diffusible hydrogen levels
- ProTech® foil bag packaging

WELDING POSITIONS

All

SHIELDING GAS

75% - 85% Argon / Balance CO₂
Flow Rate: 40-55 CFH

CONFORMANCES

AWS A.29:	E81T1-Ni2M-JH4
ABS:	3YSA H5
CWB/CSA W48:	E551T1-M21A5-Ni2-H4 [E551T1-Ni2M-JH4]
DNV - 2.9:	III Y40MS H5
Lloyd's Register:	3YS H5
ISO 17632-B:	T55 6 T1-1 M21 A-N5 H5

TYPICAL APPLICATIONS

- Mining
- Offshore
- Bridge fabrication
- High strength fabrication

DIAMETERS / PACKAGING

Diameter in (mm)	33 lb (15 kg) Spool*
0.045 (1.1)	ED032217
0.052 (1.3)	ED032277
1/16 (1.6)	ED032216

*Spool may be plastic or fiber.

MECHANICAL PROPERTIES⁽¹⁾

	Yield Strength ⁽²⁾ MPa (ksi)	Tensile Strength MPa (ksi)	Elongation %	Charpy V-Notch J [ft-lbf]	
				@ -40°C [-40°F]	@ -51°C [-60°F]
Requirements⁽⁴⁾ - AWS A5.29 E81T1-Ni2M-JH4	470 (68) min	550-670 (80-100)	19 min	27 (20) min	27 (20) min
Typical Results⁽³⁾ As-Welded with 75% Ar/25% CO ₂	555-580 (80-84)	615-635 (89-92)	25-28	69-115 (51-85)	41-89 (30-66)

DEPOSIT COMPOSITION⁽¹⁾

	%C	%Mn	%Si	%S
Requirements⁽⁴⁾ - AWS A5.29 E81T1-Ni2M-JH4	0.12 max	1.50 max	0.80 max	0.030 max
Typical Results⁽³⁾ As-Welded with 75% Ar/25% CO ₂	0.04-0.05	0.93-1.05	0.25-0.28	0.005-0.006
	%P	%Ni	%B	Diffusible Hydrogen (mL/100g weld deposit)
Requirements⁽⁴⁾ - AWS A5.29 E81T1-Ni2M-JH4	0.030 max	1.75-2.75	Not Specified	4.0 max
Typical Results⁽³⁾ As-Welded with 75% Ar/25% CO ₂	0.006-0.008	2.01-2.13	0.005-0.007	3-4

TYPICAL OPERATING PROCEDURES

Diameter, Polarity Shielding Gas	CTWD ⁽²⁾ mm (in)	Wire Feed Speed m/min (in/min)	Voltage (volts)	Approx. Current (amps)	Melt-Off Rate kg/hr (lb/hr)	Deposition Rate kg/hr (lb/hr)	Efficiency (%)
0.045 in (1.1 mm), DC+ 75%-85% Ar/ balance CO ₂	25 (1)	4.4 (175)	21-26	140	1.8 (4.0)	1.6 (3.5)	86-88
		5.1 (200)	22-27	150	2.1 (4.6)	1.8 (4.0)	
		6.4 (250)	22-27	165	2.6 (5.7)	2.3 (5.0)	
		7.6 (300)	23-28	190	3.1 (6.8)	2.7 (6.0)	
		8.9 (350)	24-29	205	3.6 (8.0)	3.2 (7.0)	
		9.5 (375)	24-29	225	3.9 (8.6)	3.4 (7.5)	
		10.8 (425)	25-30	245	4.4 (9.7)	3.8 (8.5)	
		12.1 (475)	26-31	265	4.9 (10.8)	4.3 (9.5)	
0.052 in (1.3 mm), DC+ 75%-85% Ar/ balance CO ₂	25 (1)	3.8 (150)	21-26	150	2.0 (4.5)	1.8 (3.9)	86-88
		4.7 (185)	22-27	165	2.5 (5.5)	2.2 (4.8)	
		5.7 (225)	22-27	190	3.1 (6.7)	2.7 (5.9)	
		6.4 (250)	23-28	215	3.4 (7.5)	2.9 (6.5)	
		7.0 (275)	23-28	235	3.7 (8.2)	3.2 (7.2)	
		7.6 (300)	24-29	255	4.1 (9.0)	3.5 (7.8)	
		8.5 (335)	24-30	275	4.5 (10.0)	4.0 (8.7)	
		9.5 (375)	25-31	295	5.1 (11.2)	4.4 (9.8)	
1/16 in (1.6 mm), DC+ 75%-85% Ar/ balance CO ₂	25 (1)	3.8 (150)	21-27	200	2.9 (6.3)	2.5 (5.5)	86-88
		4.4 (175)	21-28	210	3.3 (7.4)	2.9 (6.4)	
		5.1 (200)	22-29	235	3.8 (8.4)	3.3 (7.3)	
		5.7 (225)	23-30	265	4.3 (9.5)	3.7 (8.2)	
		6.4 (250)	24-31	285	4.8 (10.5)	4.2 (9.2)	
		7.0 (275)	24-32	315	5.3 (11.6)	4.6 (10.1)	
		8.3 (325)	24-32	335	6.2 (13.7)	5.4 (11.9)	
		8.9 (350)	25-33	365	6.7 (14.7)	5.8 (12.8)	

⁽¹⁾Typical all weld metal. ⁽²⁾Measured with 0.2% offset. ⁽³⁾See test results disclaimer. ⁽⁴⁾As-Welded with 75% Argon / 25% CO₂. ⁽⁵⁾To estimate ESO, subtract 1/4 in (6.0 mm) from CTWD.

ULTRACORE[®] 81Ni2C-H

Low Alloy, All Position · AWS E81T1-Ni2C-JH4

KEY FEATURES

- Capable of producing weld deposits with impact toughness exceeding 54 - 84 J (40 - 62 ft-lbf) at -51°C (-60°F)
- Designed for welding with 100% CO₂ shielding gas
- Premium arc performance and bead appearance
- H4 diffusible hydrogen levels
- ProTech[®] foil bag packaging

WELDING POSITIONS

All, except vertical down

SHIELDING GAS

100% CO₂
Flow Rate: 40-50 CFH

CONFORMANCES

AWS A5.29:	E81T1-Ni2C-JH4
ABS:	3YSA H5
CWB/CSA W48:	E551T1-C1A5-Ni2-H4 (E551T1-Ni2C-JH4)
DNV - 2.9:	III Y40MS H5
Lloyd's Register:	3YS H5
ISO 17632-B:	T55 6 T1-1 C1 A-N5 H5

TYPICAL APPLICATIONS

- Mining
- Offshore
- Bridge fabrication
- High strength fabrication

DIAMETERS / PACKAGING

Diameter in (mm)	33 lb (15 kg) Spool*
0.045 (1.1)	ED032215
0.052 (1.3)	ED032278
1/16 (1.6)	ED032214

*Spool may be plastic or fiber.

MECHANICAL PROPERTIES⁽¹⁾

	Yield Strength ⁽²⁾ MPa (ksi)	Tensile Strength MPa (ksi)	Elongation %	Charpy V-Notch J (ft-lbf)	
				@ -40°C [-40°F]	@ -51°C [-60°F]
Requirements⁽⁴⁾ - AWS A5.29 E81T1-Ni2C-JH4	470 (68) min	550-670 (80-100)	19 min	27 [20] min	27 [20] min
Typical Results⁽³⁾ As-Welded with 100% CO ₂	555-600 (80-86)	615-650 (89-94)	26-28	76-111 [56-82]	54-84 [40-62]

DEPOSIT COMPOSITION⁽¹⁾

	%C	%Mn	%Si	%S
Requirements⁽⁴⁾ - AWS A5.29 E81T1-Ni2C-JH4	0.12 max	1.50 max	0.80 max	0.030 max
Typical Results⁽⁵⁾ As-Welded with 100% CO ₂	0.04-0.05	1.14-1.24	0.27-0.32	0.006-0.007
	%P	%Ni	%B	Diffusible Hydrogen (mL/100g weld deposit)
Requirements⁽⁴⁾ - AWS A5.29 E81T1-Ni2C-JH4	0.030 max	1.75-2.75	Not Specified	4.0 max
Typical Results⁽⁵⁾ As-Welded with 100% CO ₂	0.006-0.007	1.86-2.19	0.005-0.006	2-4

TYPICAL OPERATING PROCEDURES

Diameter, Polarity Shielding Gas	CTWD ⁽²⁾ mm (in)	Wire Feed Speed m/min (in/min)	Voltage (volts)	Approx. Current (amps)	Melt-Off Rate kg/hr (lb/hr)	Deposition Rate kg/hr (lb/hr)	Efficiency [%]
0.045 in (1.1 mm), DC+ 100% CO ₂	25 (1)	4.4 (175)	23-28	140	1.8 (4.0)	1.6 (3.5)	86-88
		5.1 (200)	24-29	150	2.1 (4.6)	1.8 (4.0)	
		6.4 (250)	25-30	165	2.6 (5.7)	2.3 (5.0)	
		7.6 (300)	25-30	190	3.1 (6.8)	2.7 (6.0)	
		8.9 (350)	26-31	205	3.6 (8.0)	3.2 (7.0)	
		9.5 (375)	26-31	225	3.9 (8.6)	3.4 (7.5)	
		10.8 (425)	27-32	245	4.4 (9.7)	3.8 (8.5)	
		12.1 (475)	28-33	265	4.9 (10.8)	4.3 (9.5)	
		12.7 (500)	29-34	275	5.2 (11.4)	4.5 (10.0)	
0.052 in (1.3 mm), DC+ 100% CO ₂	25 (1)	3.8 (150)	23-28	150	2.0 (4.5)	1.8 (3.9)	86-88
		4.7 (185)	24-29	165	2.5 (5.5)	2.2 (4.8)	
		5.7 (225)	24-29	190	3.1 (6.7)	2.7 (5.9)	
		6.4 (250)	25-30	215	3.4 (7.5)	2.9 (6.5)	
		7.0 (275)	25-30	235	3.7 (8.2)	3.2 (7.2)	
		7.6 (300)	26-31	255	4.1 (9.0)	3.5 (7.8)	
		8.5 (335)	26-31	275	4.5 (10.0)	4.0 (8.7)	
		9.5 (375)	27-32	295	5.1 (11.2)	4.4 (9.8)	
		10.2 (400)	27-34	310	5.4 (12.0)	4.7 (10.4)	
1/16 in (1.6 mm), DC+ 100% CO ₂	25 (1)	3.8 (150)	24-29	200	2.9 (6.3)	2.5 (5.5)	86-88
		4.4 (175)	24-30	210	3.3 (7.4)	2.9 (6.4)	
		5.1 (200)	25-30	235	3.8 (8.4)	3.3 (7.3)	
		5.7 (225)	25-31	265	4.3 (9.5)	3.7 (8.2)	
		6.4 (250)	26-31	305	4.8 (10.5)	4.2 (9.2)	
		7.0 (275)	26-32	305	5.3 (11.6)	4.6 (10.1)	
		8.3 (325)	27-32	335	6.2 (13.7)	5.4 (11.9)	
		8.9 (350)	28-34	365	6.7 (14.7)	5.8 (12.8)	

⁽¹⁾Typical all weld metal. ⁽²⁾Measured with 0.2% offset. ⁽³⁾See test results disclaimer. ⁽⁴⁾As-Welded with 100% CO₂. ⁽⁵⁾To estimate ESO, subtract 1/4 in (6.0 mm) from CTWD.

ULTRACORE® 81K2A75-H

Low Alloy, All Position · AWS E81T1-K2M-JH4

KEY FEATURES

- Capable of producing weld deposits with impact toughness exceeding 89 - 127 J (66 - 94 ft-lbf) at -40°C (-40°F)
- Designed for welding with 75-85% Argon/ Balance CO₂ shielding gas
- Premium arc performance and bead appearance
- H4 diffusible hydrogen levels
- ProTech® foil bag packaging

WELDING POSITIONS

All, except vertical down

SHIELDING GAS

75% - 85% Argon / Balance CO₂
Flow Rate: 40 - 50 CFH

CONFORMANCES

AWS A5.29:	E81T1-K2M-JH4
ABS:	4YQ460SA H5
CWB/CSA W48:	E551T1-M21A4-K2-H4 (E551T1-K2M-JH4)
DNV - 2.9:	IV Y46MS H5
Lloyd's Register:	4Y46S H5
ISO 17632-B:	T55 4 T1-1 M21 A-N3 H5

TYPICAL APPLICATIONS

- High strength steels with 550 MPa (80 ksi) tensile strength
- Offshore
- Shipbuilding

DIAMETERS / PACKAGING

Diameter in (mm)	33 lb (15 kg) Spool*
0.045 (1.1)	ED032385
0.052 (1.3)	ED032386
1/16 (1.6)	ED032387

*Spool may be plastic or fiber.

MECHANICAL PROPERTIES⁽¹⁾

	Yield Strength ⁽²⁾ MPa (ksi)	Tensile Strength MPa (ksi)	Elongation %	Charpy V-Notch J (ft-lbf)	
				@ -29°C (-20°F)	@ -40°C (-40°F)
Requirements⁽⁴⁾ - AWS A5.29 E81T1-K2M-JH4	470 (68) min	550-690 (80-100)	19 min	27 (20) min	27 (20) min
Typical Results⁽³⁾ As-Welded with 75% Argon/25% CO ₂	535-550 (78-80)	585-605 (85-88)	26-27	117-155 (86-114)	89-127 (66-94)

DEPOSIT COMPOSITION⁽¹⁾

	%C	%Mn	%Si	%S	%P	%Ni
Requirements⁽⁴⁾ - AWS A5.29 E81T1-K2M-JH4	0.15 max	0.50-1.75	0.80 max	0.030 max	0.030 max	1.00-2.00
Typical Results⁽³⁾ As-Welded with 75% Ar/25% CO ₂	0.04-0.05	0.98-1.09	0.25-0.28	0.006-0.009	0.005-0.008	1.40-1.63
	%Cr	%Mo	%V	%B	Diffusible Hydrogen (mL/100g weld deposit)	
Requirements⁽⁴⁾ - AWS A5.29 E81T1-K2M-JH4	0.15 max	0.35 max	0.05 max	Not Specified	4 max	
Typical Results⁽³⁾ As-Welded with 75% Ar/25% CO ₂	0.03-0.04	0.01-0.02	0.02-0.03	0.005-0.007	2-4	

TYPICAL OPERATING PROCEDURES

Diameter, Polarity Shielding Gas	CTWD ⁽²⁾ mm (in)	Wire Feed Speed m/min (in/min)	Voltage (volts)	Approx. Current (amps)	Melt-Off Rate kg/hr (lb/hr)	Deposition Rate kg/hr (lb/hr)	Efficiency [%]
0.045 in (1.1 mm), DC+ 75%-85% Ar/ balance CO ₂	25 (1)	4.4 (175)	22-27	140	1.8 (4.0)	1.6 (3.5)	86-88
		5.1 (200)	23-28	150	2.1 (4.6)	1.8 (4.0)	
		6.4 (250)	24-29	165	2.6 (5.7)	2.3 (5.0)	
		7.6 (300)	24-29	190	3.1 (6.8)	2.7 (6.0)	
		8.9 (350)	25-30	205	3.6 (8.0)	3.2 (7.0)	
		9.5 (375)	25-30	225	3.9 (8.6)	3.4 (7.5)	
		10.8 (425)	26-31	245	4.4 (9.7)	3.8 (8.5)	
		12.1 (475)	27-32	265	4.9 (10.8)	4.3 (9.5)	
12.7 (500)	28-33	275	5.2 (11.4)	4.5 (10.0)			
0.052 in (1.3 mm), DC+ 75%-85% Ar/ balance CO ₂	25 (1)	3.8 (150)	22-27	150	2.0 (4.5)	1.8 (3.9)	86-88
		4.7 (185)	23-28	165	2.5 (5.5)	2.2 (4.8)	
		5.7 (225)	23-28	190	3.1 (6.7)	2.7 (5.9)	
		6.4 (250)	24-29	215	3.4 (7.5)	2.9 (6.5)	
		6.9 (275)	24-29	235	3.7 (8.2)	3.2 (7.2)	
		7.6 (300)	25-30	255	4.1 (9.0)	3.5 (7.8)	
		8.5 (335)	25-31	275	4.5 (10.0)	4.0 (8.7)	
		9.5 (375)	26-32	295	5.1 (11.2)	4.4 (9.8)	
10.2 (400)	26-33	310	5.4 (12.0)	4.7 (10.4)			
1/16 in (1.6 mm), DC+ 75%-85% Ar/ balance CO ₂	25 (1)	3.8 (150)	22-27	200	2.9 (6.3)	2.5 (5.5)	86-88
		4.4 (175)	23-28	210	3.3 (7.4)	2.9 (6.4)	
		5.1 (200)	24-29	235	3.8 (8.4)	3.3 (7.3)	
		5.7 (225)	24-29	265	4.3 (9.5)	3.7 (8.2)	
		6.4 (250)	25-30	285	4.8 (10.5)	4.2 (9.2)	
		6.9 (275)	25-31	315	5.3 (11.6)	4.6 (10.1)	
		8.3 (325)	26-32	335	6.2 (13.7)	5.4 (11.9)	
		8.9 (350)	27-33	365	6.7 (14.7)	5.8 (12.8)	

⁽¹⁾Typical all weld metal. ⁽²⁾Measured with 0.2% offset. ⁽³⁾See test results disclaimer ⁽⁴⁾As-Welded with 75% Argon/25% CO₂. ⁽⁵⁾To estimate ESO, subtract 1/4 in (6.0 mm) from CTWD.

ULTRACORE® 81K2C-H

Low Alloy, All Position · AWS E81T1-K2C-JH4, E81T1-C1A5-K2-H4

KEY FEATURES

- Capable of producing weld deposits with impact toughness exceeding 111 - 141 J (82 - 104 ft-lbf) at -40°C [-40°F]
- Designed for welding with 100% CO₂ shielding gas
- Premium arc performance and bead appearance
- H4 diffusible hydrogen levels
- ProTech® foil bag packaging

WELDING POSITIONS

All

CONFORMANCES

AWS A5.29:	E81T1-K2C-JH4
AWS A5.36:	E81T1-C1A5-K2-H4
ASME SFA-A5.29:	E81T1-K2C-JH4
ABS:	4YQ460SA H5
Lloyd's Register:	4Y46S H5
DNV Grade:	IV 46MS H5
EN ISO 17632-B:	T554T1-1CA-N3-H5

TYPICAL APPLICATIONS

- High strength steels with 550 MPa (80 ksi) tensile strength
- Offshore
- Shipbuilding

SHIELDING GAS

100% CO₂
Flow Rate: 40 - 50 CFH

DIAMETERS / PACKAGING

Diameter in (mm)	33 lb (15 kg) Spool*
0.045 (1.1)	ED032388
0.052 (1.3)	ED032389
1/16 (1.6)	ED032390

*Spool may be plastic or fiber.

MECHANICAL PROPERTIES⁽¹⁾

	Yield Strength ⁽²⁾ MPa (ksi)	Tensile Strength MPa (ksi)	Elongation %	Charpy V-Notch J (ft-lbf)	
				@ -29°C [-20°F]	@ -40°C [-40°F]
Requirements - AWS E81T1-K2C-JH4 As-Welded with 100% CO ₂	470 (68) min	550-690 (80-100)	19 min	27 (20) min	27 (20) min
Typical Results⁽³⁾ As-Welded with 100% CO ₂	530-555 (77-80)	580-610 (84-88)	27-29	127-157 (94-116)	111-141 (82-104)

DEPOSIT COMPOSITION⁽¹⁾

	%C	%Mn	%Si	%S	%P	%Ni
Requirements⁽⁴⁾ - AWS E81T1-K2C-JH4	0.15 max	0.50-1.75	0.80 max	0.030 max	0.030 max	1.00-2.00
Typical Results⁽⁵⁾ As-Welded with 100% CO ₂	0.04	1.08-1.15	0.23-0.31	0.005-0.009	0.005-0.009	1.30-1.62
	%Cr	%Mo	%V	%B	Diffusible Hydrogen (mL/100g weld deposit)	
Requirements⁽⁴⁾ - AWS E81T1-K2C-JH4	0.15 max	0.35 max	0.05 max	Not Specified	4.0 max	
Typical Results⁽⁵⁾ As-Welded with 100% CO ₂	0.03-0.05	0.01-0.02	0.01-0.02	0.005-0.006	2-3	

TYPICAL OPERATING PROCEDURES

Diameter, Polarity Shielding Gas	CTWD ⁽²⁾ mm (in)	Wire Feed Speed m/min (in/min)	Voltage (volts)	Approx. Current (amps)	Melt-Off Rate kg/hr (lb/hr)	Deposition Rate kg/hr (lb/hr)	Efficiency (%)
0.045 in (1.1 mm), DC+ 100% CO ₂	25 (1)	4.4 (175)	23-28	140	1.8 (4.0)	1.6 (3.5)	86-88
		5.1 (200)	24-29	150	2.1 (4.6)	1.8 (4.0)	
		6.4 (250)	25-30	165	2.6 (5.7)	2.3 (5.0)	
		7.6 (300)	25-30	190	3.1 (6.8)	2.7 (6.0)	
		8.9 (350)	26-31	205	3.6 (8.0)	3.2 (7.0)	
		9.5 (375)	26-31	225	3.9 (8.6)	3.4 (7.5)	
		10.8 (425)	27-32	245	4.4 (9.7)	3.8 (8.5)	
		12.1 (475)	28-33	265	4.9 (10.8)	4.3 (9.5)	
0.052 in (1.3 mm), DC+ 100% CO ₂	25 (1)	3.8 (150)	23-28	150	2.0 (4.5)	1.8 (3.9)	86-88
		4.7 (185)	24-29	165	2.5 (5.5)	2.2 (4.8)	
		5.7 (225)	24-29	190	3.1 (6.7)	2.7 (5.9)	
		6.4 (250)	25-30	215	3.4 (7.5)	2.9 (6.5)	
		6.9 (275)	25-30	235	3.7 (8.2)	3.2 (7.2)	
		7.6 (300)	26-31	255	4.1 (9.0)	3.5 (7.8)	
		8.5 (335)	26-31	275	4.5 (10.0)	4.0 (8.7)	
		9.5 (375)	27-32	295	5.1 (11.2)	4.4 (9.8)	
1/16 in (1.6 mm), DC+ 100% CO ₂	25 (1)	3.8 (150)	24-29	200	2.9 (6.3)	2.5 (5.5)	86-88
		4.4 (175)	24-30	210	3.3 (7.4)	2.9 (6.4)	
		5.1 (200)	25-30	235	3.8 (8.4)	3.3 (7.3)	
		5.7 (225)	25-31	265	4.3 (9.5)	3.7 (8.2)	
		6.4 (250)	26-31	285	4.8 (10.5)	4.2 (9.2)	
		6.9 (275)	26-32	305	5.3 (11.6)	4.6 (10.1)	
		8.3 (325)	27-32	335	6.2 (13.7)	5.4 (11.9)	
		8.9 (350)	28-34	365	6.7 (14.7)	5.8 (12.8)	

⁽¹⁾Typical all weld metal. ⁽²⁾Measured with 0.2% offset. ⁽³⁾See test results disclaimer ⁽⁴⁾As-Welded with 100% CO₂. ⁽⁵⁾To estimate ESO, subtract 1/4 in (6.0 mm) from CTWD.

ULTRACORE® 81K2C-H PLUS

Low Alloy, All Positions · AWS E81T1-K2C-JH4

KEY FEATURES

- Innovative design capable of superior toughness at -60°F in both the as-welded and stress-relieved conditions
- Designed for welding with 100% CO₂ shielding gas
- H4 diffusible hydrogen levels
- Q2 Lot® - Certificate showing actual deposit chemistry and mechanical properties per lot available online
- ProTech® foil bag packaging

WELDING POSITIONS

All

CONFORMANCES

- AWS A5:** E81T1-K2C-JH4
ABS: 4YQ460SA H5
DNV: IV Y46MS H5
Lloyd's Register: 4Y46S H5

TYPICAL APPLICATIONS

- Offshore drilling rigs
- Ship building
- Low temperature storage tanks
- Construction

SHIELDING GAS

100% CO₂
 Flow Rate: 40-50 CFH

DIAMETERS / PACKAGING

Diameter in (mm)	33 lb (15kg) Plastic Spool
0.045 (1.1)	ED034864
0.052 (1.3)	ED034865
1/16 (1.6)	ED034866

MECHANICAL PROPERTIES⁽¹⁾

	Yield Strength ⁽²⁾ MPa [ksi]	Tensile Strength MPa [ksi]	Elongation [%]	Charpy V-Notch J [ft-lbf]	
				-40°C [-40°F]	-51°C [-60°F]
Requirements AWS A5.29: E81T1-K2C-JH4 As-Welded with 100% CO ₂	470 (68) min	550-690 (80-100)	19 min	27 (20) min	-
Typical Results⁽³⁾ As-Welded with 100% CO ₂	491-531 (71-77)	576-604 (84-88)	24-26	107-117 (79-86)	119-135 (88-100)
Stress Relieved with 100% CO ₂ for 1 hr @ 621°C (1150°F)	477-488 (69-71)	575-580 (83-84)	27	120-147 (89-108)	-

⁽¹⁾ Typical all weld metal. ⁽²⁾ Measure with 0.2% offset. ⁽³⁾ See test results disclaimer

DEPOSIT COMPOSITION⁽¹⁾

	%C	%Mn	%Si	%S	%P	%Ni
Requirements AWS A5.29: E81T1-K2C-JH4	0.15 max	0.50-1.75	0.80 max	0.030 max	0.030 max	1.00-2.00
Typical Results⁽²⁾	0.05	1.39-1.56	0.30-0.36	0.007-0.008	0.013	1.54-1.72
	%Cr	%Mo	%V	%B	Diffusible Hydrogen (mL/100g weld deposit)	
Requirements AWS A5.29: E81T1-K2C-JH4	0.15 max	0.35 max	0.05 max	Not Specified	4.0 max	
Test Results⁽³⁾	0.07	0.02	0.01	0.004-0.005	2-4	

TYPICAL OPERATING PROCEDURES

Diameter, Polarity Shielding Gas	CTWD ⁽⁴⁾ mm (in)	Wire Feed Speed m/min (in/min)	Voltage (volts)	Approx. Current (amps)	Melt-Off Rate kg/hr (lb/hr)	Deposition Rate kg/hr (lb/hr)	Efficiency (%)
0.045 in (1.1 mm), DC+	19 (3/4)	4.4 (175)	25 - 29	120	1.8 (3.9)	1.5 (3.4)	85-87
	19 (3/4)	6.4 (250)	26 - 30	140	2.5 (5.6)	2.2 (4.8)	
	19 (3/4)	7.6 (300)	27 - 31	155	3.1 (6.8)	2.6 (5.8)	
	19 (3/4)	8.9 (350)	28 - 32	170	3.6 (7.9)	3.1 (6.8)	
	25 (1)	10.2 (400)	29 - 33	185	4.1 (9.0)	3.5 (7.8)	
	25 (1)	11.4 (450)	29 - 33	200	4.6 (10.1)	4.0 (8.8)	
	25 (1)	12.7 (500)	30 - 34	220	5.1 (11.3)	4.4 (9.8)	
0.052 in (1.3 mm), DC+	19 (3/4)	3.8 (150)	25 - 29	150	2.1 (4.7)	1.7 (3.8)	81-84
	19 (3/4)	5.1 (200)	26 - 30	170	2.9 (6.3)	2.4 (5.2)	
	19 (3/4)	6.4 (250)	27 - 31	195	3.5 (7.8)	3.0 (6.5)	
	25 (1)	7.6 (300)	28 - 32	215	4.3 (9.4)	3.6 (7.9)	
	25 (1)	8.9 (350)	29 - 33	240	5.0 (11.0)	4.2 (9.2)	
1/16 in (1.6 mm), DC+	19 (3/4)	3.8 (150)	26 - 30	190	2.9 (6.4)	2.4 (5.3)	83-87
	19 (3/4)	4.4 (175)	26 - 30	205	3.4 (7.5)	2.9 (6.3)	
	19 (3/4)	5.1 (200)	27 - 31	220	3.9 (8.5)	3.3 (7.2)	
	19 (3/4)	5.7 (225)	27 - 31	230	4.4 (9.6)	3.7 (8.1)	
	19 (3/4)	6.4 (250)	28 - 32	245	4.8 (10.6)	4.1 (9.1)	
	25 (1)	7.6 (300)	28 - 32	275	5.8 (12.7)	4.9 (10.9)	
	25 (1)	8.3 (325)	29 - 33	290	6.3 (13.8)	5.4 (11.9)	
	25 (1)	8.9 (350)	29 - 33	300	6.7 (14.8)	5.8 (12.8)	

⁽¹⁾ Typical all weld metal. ⁽²⁾ Measure with 0.2% offset. ⁽³⁾ See test results disclaimer ⁽⁴⁾ To estimate ESO, subtract 1/4 in (6.0 mm) from CTWD.

ULTRACORE® 81K2M-H PLUS

Low Alloy, All Positions • AWS E81T1-K2M-JH4

KEY FEATURES

- Innovative design capable of superior toughness at -60°F in both the as-welded and stress-relieved conditions
- Designed for welding with 75-80% Argon/ Balance CO₂ shielding gas
- H4 diffusible hydrogen levels
- Q2 Lot® - Certificate showing actual deposit chemistry and mechanical properties per lot available online
- ProTech® foil bag packaging

CONFORMANCES

AWS A5: E81T1-K2M-JH4

TYPICAL APPLICATIONS

- Offshore drilling rigs
- Ship building
- Low temperature storage tanks
- Construction

WELDING POSITIONS

All

SHIELDING GAS

75-80% Argon / Balance CO₂
Flow Rate: 40-50 CFH

DIAMETERS / PACKAGING

Diameter in (mm)	33 lb (15kg) Plastic Spool
0.045 (1.1)	ED034861
0.052 (1.3)	ED034862
1/16 (1.6)	ED034863

MECHANICAL PROPERTIES⁽¹⁾

	Yield Strength ⁽²⁾ MPa (ksi)	Tensile Strength MPa (ksi)	Elongation [%]	Charpy V-Notch J (ft-lbf)	
				-40°C (-40°F)	-51°C (-60°F)
Requirements AWS A5.29: E81T1-K2M-JH4 As-Welded with 75% Ar / 25% CO ₂	470 (68) min	550-690 (80-100)	19 min	27 (20) min	-
Typical Results⁽³⁾ As-Welded with 75% Ar / 25% CO ₂	503-550 (73-80)	588-628 (85-91)	21-24	107-117 (79-86)	97-111 (72-82)
Stress Relieved with 75% Ar / 25% CO ₂ for 1 hr @ 621°C (1150°F)	480-490 (69-71)	570-590 (83-85)	27-29	81-94 (60-70)	-

⁽¹⁾ Typical all weld metal. ⁽²⁾ Measure with 0.2% offset. ⁽³⁾ See test results disclaimer

DEPOSIT COMPOSITION⁽¹⁾

	%C	%Mn	%Si	%S	%P	%Ni
Requirements AWS A5.29: E81T1-K2M-JH4	0.15 max	0.50-1.75	0.80 max	0.030 max	0.030 max	1.00-2.00
Typical Results⁽²⁾ with 75% Argon / 25% CO ₂	0.05	1.28-1.30	0.42-0.44	0.007-0.009	0.011	1.45-1.60
	%Cr	%Mo	%V	%B	Diffusible Hydrogen (mL/100g weld deposit)	
Requirements AWS A5.29: E81T1-K2M-JH4	0.15 max	0.35 max	0.05 max	Not Specified	4.0 max	
Typical Results⁽²⁾ with 75% Argon / 25% CO ₂	0.05	0.01	0.00	0.005-0.006	2-4	

TYPICAL OPERATING PROCEDURES

Diameter, Polarity Shielding Gas	CTWD ⁽⁴⁾ mm (in)	Wire Feed Speed m/min (in/min)	Voltage (volts)	Approx. Current (amps)	Melt-Off Rate kg/hr (lb/hr)	Deposition Rate kg/hr (lb/hr)	Efficiency (%)
0.045 in (1.1 mm), DC+	19 (3/4)	4.4 (175)	24 - 28	120	1.8 (3.9)	1.5 (3.4)	85-87
	19 (3/4)	6.4 (250)	25 - 29	140	2.5 (5.6)	2.2 (4.8)	
	19 (3/4)	7.6 (300)	26 - 30	155	3.1 (6.8)	2.6 (5.8)	
	19 (3/4)	8.9 (350)	27 - 31	170	3.6 (7.9)	3.1 (6.8)	
	25 (1)	10.2 (400)	28 - 32	185	4.1 (9.0)	3.5 (7.8)	
	25 (1)	11.4 (450)	28 - 32	200	4.6 (10.1)	4.0 (8.8)	
	25 (1)	12.7 (500)	29 - 33	220	5.1 (11.3)	4.4 (9.8)	
0.052 in (1.3 mm), DC+	19 (3/4)	3.8 (150)	24 - 28	150	2.1 (4.7)	1.7 (3.8)	81-84
	19 (3/4)	5.1 (200)	25 - 29	170	2.9 (6.3)	2.4 (5.2)	
	19 (3/4)	6.4 (250)	26 - 30	195	3.5 (7.8)	3.0 (6.5)	
	25 (1)	7.6 (300)	27 - 31	215	4.3 (9.4)	3.6 (7.9)	
	25 (1)	8.9 (350)	28 - 32	240	5.0 (11.0)	4.2 (9.2)	
1/16 in (1.6 mm), DC+	19 (3/4)	3.8 (150)	25 - 29	190	2.9 (6.4)	2.4 (5.3)	83-87
	19 (3/4)	4.4 (175)	25 - 29	205	3.4 (7.5)	2.9 (6.3)	
	19 (3/4)	5.1 (200)	26 - 30	220	3.9 (8.5)	3.3 (7.2)	
	19 (3/4)	5.7 (225)	26 - 30	230	4.4 (9.6)	3.7 (8.1)	
	19 (3/4)	6.4 (250)	27 - 31	245	4.8 (10.6)	4.1 (9.1)	
	25 (1)	7.6 (300)	27 - 31	275	5.8 (12.7)	4.9 (10.9)	
	25 (1)	8.3 (325)	28 - 32	290	6.3 (13.8)	5.4 (11.9)	
	25 (1)	8.9 (350)	28 - 32	300	6.7 (14.8)	5.8 (12.8)	

⁽¹⁾ Typical all weld metal. ⁽²⁾ Measure with 0.2% offset. ⁽³⁾ See test results disclaimer ⁽⁴⁾ To estimate ESO, subtract 1/4 in (6.0 mm) from CTWD.

ULTRACORE® 91K2C-H PLUS

Low Alloy, All Positions • AWS E91T1-K2C-JH4

KEY FEATURES

- Innovative design capable of superior toughness at -60°F in both the as-welded and stress-relieved conditions
- Designed for welding with 100% CO₂ shielding gas
- H4 diffusible hydrogen levels
- Q2 Lot® - Certificate showing actual deposit chemistry and mechanical properties per lot available online
- ProTech® foil bag packaging

WELDING POSITIONS

All

CONFORMANCES

- AWS A5:** E91T1-K2C-JH4
ABS: 4YQ500SA H5
DNV: IV Y50MS H5
Lloyd's Register: 4Y50S H5

TYPICAL APPLICATIONS

- Offshore drilling rigs
- Ship building
- Low temperature storage tanks
- Construction

SHIELDING GAS

100% CO₂
 Flow Rate: 40-50 CFH

DIAMETERS / PACKAGING

Diameter in (mm)	33 lb (15kg) Fiber Spool (Plastic Bag)
0.045 (1.1)	ED035381
0.052 (1.3)	ED035382
1/16 (1.6)	ED035383

MECHANICAL PROPERTIES⁽¹⁾

	Yield Strength ⁽²⁾ MPa (ksi)	Tensile Strength MPa (ksi)	Elongation [%]	Charpy V-Notch J (ft-lbf)	
				-40°C (-40°F)	-51°C (-60°F)
Requirements AWS A5.29 E91T1-K2C-JH4 As-Welded with 100% CO ₂	540 (78) min	620-760 (90-110)	17 min	27 (20) min	-
Typical Results⁽³⁾ As-Welded with 100% CO ₂	610-650 (88-94)	665-680 (96-99)	23-25	85-93 (63-69)	75-80 (55-59)
Stress Relieved with 100% CO ₂ for 1 hr @ 620°C (1150°F)	580-610 (84-88)	650-675 (94-98)	23-29	85-93 (63-69)	-

⁽¹⁾ Typical all weld metal. ⁽²⁾ Measure with 0.2% offset. ⁽³⁾ See test results disclaimer

DEPOSIT COMPOSITION⁽¹⁾

	%C	%Mn	%Si	%S	%P	%Ni
Requirements AWS A5.29 E91T1-K2C-JH4	0.15 max	0.50-1.75	0.80 max	0.030 max	0.030 max	1.00-2.00
Typical Results⁽²⁾ As-Welded with 100% CO ₂	0.04-0.07	1.39-1.73	0.25-0.35	0.006-0.008	0.009-0.011	1.33-1.66
	%Cr	%Mo	%V	%B	Diffusible Hydrogen (mL/100g weld deposit)	
Requirements AWS A5.29 E91T1-K2C-JH4	0.15 max	0.35 max	0.05 max	Not Specified	4.0 max	
Typical Results⁽²⁾ As-Welded with 100% CO ₂	0.04-0.05	0.22-0.29	0.00	0.003-0.004	1-3	

TYPICAL OPERATING PROCEDURES

Diameter, Polarity Shielding Gas	CTWD ⁽⁴⁾ mm (in)	Wire Feed Speed m/min (in/min)	Voltage (volts)	Approx. Current (amps)	Melt-Off Rate kg/hr (lb/hr)	Deposition Rate kg/hr (lb/hr)	Efficiency (%)
0.045 in (1.1 mm), DC+	19 (3/4)	4.4 (175)	25 - 29	130	1.9 (4.1)	1.7 (3.7)	89-90
	19 (3/4)	6.4 (250)	27 - 31	170	2.6 (5.8)	2.4 (5.2)	
	19 (3/4)	7.6 (300)	28 - 32	195	3.2 (7.0)	2.8 (6.2)	
	19 (3/4)	8.9 (350)	28 - 32	220	3.7 (8.1)	3.3 (7.2)	
	25 (1)	10.2 (400)	28 - 32	225	4.2 (9.2)	3.7 (8.2)	
	25 (1)	11.4 (450)	29 - 33	245	4.7 (10.4)	4.2 (9.2)	
	25 (1)	12.7 (500)	30 - 34	265	5.2 (11.5)	4.6 (10.2)	
0.052 in (1.3 mm), DC+	19 (3/4)	3.8 (150)	26 - 30	160	2.1 (4.6)	1.7 (3.8)	82-84
	19 (3/4)	4.4 (175)	26 - 30	180	2.4 (5.4)	2.0 (4.5)	
	19 (3/4)	5.1 (200)	27 - 31	200	2.8 (6.2)	2.3 (5.1)	
	19 (3/4)	5.7 (225)	27 - 31	220	3.2 (7.0)	2.6 (5.8)	
	19 (3/4)	7.0 (275)	28 - 32	255	3.9 (8.5)	3.2 (7.1)	
	25 (1)	7.6 (300)	28 - 32	230	4.2 (9.3)	3.5 (7.8)	
	25 (1)	8.3 (325)	28 - 32	245	4.6 (10.1)	3.8 (8.4)	
25 (1)	8.9 (350)	29 - 33	255	4.9 (10.9)	4.1 (9.1)		
1/16 in (1.6 mm), DC+	19 (3/4)	3.8 (150)	26 - 30	205	2.9 (6.3)	2.4 (5.2)	83-85
	19 (3/4)	4.4 (175)	27 - 31	230	3.4 (7.4)	2.8 (6.2)	
	19 (3/4)	5.1 (200)	27 - 31	250	3.8 (8.4)	3.2 (7.1)	
	19 (3/4)	5.7 (225)	28 - 32	270	4.3 (9.5)	3.6 (8.0)	
	19 (3/4)	7.0 (275)	28 - 32	305	5.3 (11.6)	4.4 (9.8)	
	25 (1)	7.6 (300)	28 - 32	305	5.8 (12.7)	4.9 (10.7)	
	25 (1)	8.3 (325)	29 - 33	320	6.2 (13.7)	5.3 (11.6)	
25 (1)	8.9 (350)	29 - 33	335	6.7 (14.8)	5.7 (12.6)		

⁽¹⁾ Typical all weld metal. ⁽²⁾ Measure with 0.2% offset. ⁽³⁾ See test results disclaimer ⁽⁴⁾ To estimate ESO, subtract 1/4 in (6.0 mm) from CTWD.

ULTRACORE[®] 91K2M-H PLUS

Low Alloy, All Positions • AWS E91T1-K2M-JH4

KEY FEATURES

- Innovative design capable of superior toughness at -60°F in both the as-welded and stress-relieved conditions
- Designed for welding with 75-80% Argon/ Balance CO₂ shielding gas
- H4 diffusible hydrogen levels
- Q2 Lot[®] - Certificate showing actual deposit chemistry and mechanical properties per lot available online
- ProTech[®] foil bag packaging

WELDING POSITIONS

All

CONFORMANCES

- AWS A5:** E91T1-K2M-JH4
- ABS:** 4YQ500SA H5
- CWB/CSA:** E621T1-M21A5-K2-H4 (E91T1-M21A6-K2-H4)
- DNV:** IV Y50MS H5
- Lloyd's Register:** 4Y50S H5

TYPICAL APPLICATIONS

- Offshore drilling rigs
- Ship building
- Low temperature storage tanks
- Construction

SHIELDING GAS

75-80% Argon / Balance CO₂
Flow Rate: 40-50 CFH

DIAMETERS / PACKAGING

Diameter in (mm)	33 lb (15 kg) Fiber Spool (Plastic Bag)
0.045 (1.1)	ED035378
0.052 (1.3)	ED035379
1/16 (1.6)	ED035380

MECHANICAL PROPERTIES⁽¹⁾

	Yield Strength ⁽²⁾ MPa (ksi)	Tensile Strength MPa (ksi)	Elongation [%]	Charpy V-Notch J (ft-lbf)	
				-40°C (-40°F)	-51°C (-60°F)
Requirements AWS A5.29 E91T1-K2M-JH4 As-Welded with 75% Ar / 25% CO ₂	540 (78) min	620-760 (90-110)	17 min	27 (20) min	-
Typical Results⁽³⁾ As-Welded with 75% Argon / 25% CO ₂	615-630 (89-91)	670-685 (97-99)	23-24	84-88 (62-65)	65-69 (48-51)
Stress Relieved with 75% Ar / 25% CO ₂ for 1 hr @ 620°C (1150°F)	570-585 (83-85)	635-655 (92-95)	24-27	84-88 (62-65)	-

⁽¹⁾ Typical all weld metal. ⁽²⁾ Measure with 0.2% offset. ⁽³⁾ See test results disclaimer

DEPOSIT COMPOSITION⁽¹⁾

	%C	%Mn	%Si	%S	%P	%Ni
Requirements AWS A5.29 E91T1-K2M-JH4	0.15 max	0.50-1.75	0.80 max	0.030 max	0.030 max	1.00-2.00
Typical Results⁽²⁾ As-Welded with 75% Argon / 25% CO ₂	0.04-0.05	1.50-1.66	0.30-0.35	0.006-0.012	0.008-0.010	1.44-1.58
	%Cr	%Mo	%V	%B	Diffusible Hydrogen (mL/100g weld deposit)	
Requirements AWS A5.29 E91T1-K2M-JH4	0.15 max	0.35 max	0.05 max	Not Specified	4.0 max	
Typical Results⁽²⁾ As-Welded with 75% Argon / 25% CO ₂	0.04-0.05	0.24-0.27	0.00	0.004-0.005	1-3	

TYPICAL OPERATING PROCEDURES

Diameter, Polarity Shielding Gas	CTWD ⁽⁴⁾ mm (in)	Wire Feed Speed m/min (in/min)	Voltage (volts)	Approx. Current (amps)	Melt-Off Rate kg/hr (lb/hr)	Deposition Rate kg/hr (lb/hr)	Efficiency (%)
0.045 in (1.1 mm), DC+	19 (3/4)	4.4 (175)	25 - 28	130	1.9 (4.1)	1.7 (3.7)	89-90
	19 (3/4)	6.4 (250)	27 - 30	170	2.6 (5.8)	2.4 (5.2)	
	19 (3/4)	7.6 (300)	28 - 31	195	3.2 (7.0)	2.8 (6.2)	
	19 (3/4)	8.9 (350)	29 - 32	220	3.7 (8.1)	3.3 (7.2)	
	25 (1)	10.2 (400)	29 - 32	225	4.2 (9.2)	3.7 (8.2)	
	25 (1)	11.4 (450)	30 - 33	245	4.7 (10.4)	4.2 (9.2)	
	25 (1)	12.7 (500)	30 - 33	265	5.2 (11.5)	4.6 (10.2)	
0.052 in (1.3 mm), DC+	19 (3/4)	3.8 (150)	26 - 29	160	2.1 (4.6)	1.7 (3.8)	82-84
	19 (3/4)	4.4 (175)	26 - 29	180	2.4 (5.4)	2.0 (4.5)	
	19 (3/4)	5.1 (200)	27 - 30	200	2.8 (6.2)	2.3 (5.1)	
	19 (3/4)	5.7 (225)	27 - 30	220	3.2 (7.0)	2.6 (5.8)	
	19 (3/4)	7.0 (275)	28 - 31	255	3.9 (8.5)	3.2 (7.1)	
	25 (1)	7.6 (300)	28 - 31	230	4.2 (9.3)	3.5 (7.8)	
	25 (1)	8.3 (325)	28 - 31	245	4.6 (10.1)	3.8 (8.4)	
25 (1)	8.9 (350)	29 - 32	255	4.9 (10.9)	4.1 (9.1)		
1/16 in (1.6 mm), DC+	19 (3/4)	3.8 (150)	26 - 29	205	2.9 (6.3)	2.4 (5.2)	83-85
	19 (3/4)	4.4 (175)	27 - 30	230	3.4 (7.4)	2.8 (6.2)	
	19 (3/4)	5.1 (200)	27 - 30	250	3.8 (8.4)	3.2 (7.1)	
	19 (3/4)	5.7 (225)	28 - 31	270	4.3 (9.5)	3.6 (8.0)	
	19 (3/4)	7.0 (275)	29 - 32	305	5.3 (11.6)	4.4 (9.8)	
	25 (1)	7.6 (300)	29 - 32	305	5.8 (12.7)	4.9 (10.7)	
	25 (1)	8.3 (325)	29 - 32	320	6.2 (13.7)	5.3 (11.6)	
25 (1)	8.9 (350)	29 - 32	335	6.7 (14.8)	5.7 (12.6)		

⁽¹⁾ Typical all weld metal. ⁽²⁾ Measure with 0.2% offset. ⁽³⁾ See test results disclaimer. ⁽⁴⁾ To estimate ESO, subtract 1/4 in (6.0 mm) from CTWD.

ULTRACORE® 101K3M-H PLUS

Low Alloy, All Positions • AWS E101T1-K3M-JH4

KEY FEATURES

- Innovative design capable of superior toughness at -60°F in both the as-welded and stress-relieved conditions
- Designed for welding with 75-80% Argon/ Balance CO₂ shielding gas
- H4 diffusible hydrogen levels
- Q2 Lot® - Certificate showing actual deposit chemistry and mechanical properties per lot available online
- ProTech® foil bag packaging

CONFORMANCES

AWS A5: E101T1-K3M-JH4

TYPICAL APPLICATIONS

- Offshore drilling rigs
- Low temperature storage tanks
- Ship building
- Construction

WELDING POSITIONS

All

SHIELDING GAS

75-80% Argon / Balance CO₂
Flow Rate: 40-50 CFH

DIAMETERS / PACKAGING

Diameter in (mm)	33 lb (15 kg) Fiber Spool (Plastic Bag)
0.045 (1.1)	ED035413
0.052 (1.3)	ED035414

MECHANICAL PROPERTIES⁽¹⁾

	Yield Strength ⁽²⁾ MPa (ksi)	Tensile Strength MPa (ksi)	Elongation (%)	Charpy V-Notch J (ft-lbf)	
				-40°C (-40°F)	-51°C (-60°F)
Requirements AWS A5.29 E101T1-K3M-JH4 As-Welded with 75% Ar / 25% CO ₂	605 (88) min	690-825 (100-120)	16 min	27 (20) min	-
Typical Results⁽³⁾ As-Welded with 75% Argon / 25% CO ₂	695-710 (100-103)	740-765 (108-111)	21-23	55-60 (40-44)	48-53 (35-39)
Stress Relieved with 75% Ar / 25% CO ₂ for 1 hr @ 620°C (1150°F)	655-670 (95-97)	720-730 (104-106)	22-23	55-60 (40-44)	-

⁽¹⁾ Typical all weld metal. ⁽²⁾ Measure with 0.2% offset. ⁽³⁾ See test results disclaimer

DEPOSIT COMPOSITION⁽¹⁾

	%C	%Mn	%Si	%S	%P	%Ni
Requirements AWS A5.29 E101T1-K3M-JH4	0.15 max	0.75-2.25	0.80 max	0.030 max	0.030 max	1.25-2.60
Typical Results⁽²⁾ As-Welded with 75% Argon / 25% CO ₂	0.04-0.05	1.60-1.71	0.33-0.34	0.007-0.008	0.010-0.011	1.89-2.17
	%Cr	%Mo	%V	%B	Diffusible Hydrogen (mL/100g weld deposit)	
Requirements AWS A5.29 E101T1-K3M-JH4	0.15 max	0.25-0.65	0.05 max	Not Specified	4.0 max	
Typical Results⁽²⁾ As-Welded with 75% Argon / 25% CO ₂	0.04-0.06	0.39-0.44	0.00	0.004-0.005	1-3	

TYPICAL OPERATING PROCEDURES

Diameter, Polarity Shielding Gas	CTWD ⁽⁴⁾ mm (in)	Wire Feed Speed m/min (in/min)	Voltage (volts)	Approx. Current (amps)	Melt-Off Rate kg/hr (lb/hr)	Deposition Rate kg/hr (lb/hr)	Efficiency (%)
0.045 in (1.1 mm), DC+	19 (3/4)	4.4 (175)	24 - 28	120	1.8 (3.9)	1.5 (3.4)	85-87
	19 (3/4)	6.4 (250)	25 - 29	140	2.5 (5.6)	2.2 (4.8)	
	19 (3/4)	7.6 (300)	26 - 30	155	3.1 (6.8)	2.6 (5.8)	
	19 (3/4)	8.9 (350)	27 - 31	170	3.6 (7.9)	3.1 (6.8)	
	25 (1)	10.2 (400)	28 - 32	185	4.1 (9.0)	3.5 (7.8)	
	25 (1)	11.4 (450)	28 - 32	200	4.6 (10.1)	4.0 (8.8)	
	25 (1)	12.7 (500)	29 - 33	220	5.1 (11.3)	4.4 (9.8)	
0.052 in (1.3 mm), DC+	19 (3/4)	3.8 (150)	26 - 29	160	2.1 (4.6)	1.7 (3.8)	82-84
	19 (3/4)	4.4 (175)	26 - 29	180	2.4 (5.4)	2.0 (4.5)	
	19 (3/4)	5.1 (200)	27 - 30	200	2.8 (6.2)	2.3 (5.1)	
	19 (3/4)	5.7 (225)	27 - 30	220	3.2 (7.0)	2.6 (5.8)	
	19 (3/4)	7.0 (275)	28 - 31	255	3.9 (8.5)	3.2 (7.1)	
	25 (1)	7.6 (300)	28 - 31	230	4.2 (9.3)	3.5 (7.8)	
	25 (1)	8.3 (325)	28 - 31	245	4.6 (10.1)	3.8 (8.4)	
25 (1)	8.9 (350)	29 - 32	255	4.9 (10.9)	4.1 (9.1)		

⁽¹⁾ Typical all weld metal. ⁽²⁾ Measure with 0.2% offset. ⁽³⁾ See test results disclaimer ⁽⁴⁾ To estimate ESO, subtract 1/4 in (6.0 mm) from CTWD.

ULTRACORE® 111K3C-H PLUS

Low Alloy, All Positions · AWS E111T1-K3C-JH4

KEY FEATURES

- Innovative design capable of superior toughness at -60°F in both the as-welded and stress-relieved conditions
- Designed for welding with 100% CO₂ shielding gas
- H4 diffusible hydrogen levels
- Q2 Lot® - Certificate showing actual deposit chemistry and mechanical properties per lot available online
- ProTech® foil bag packaging

WELDING POSITIONS

All

CONFORMANCES

AWS A5.29: E101T1-K3M-JH4

TYPICAL APPLICATIONS

- Offshore drilling rigs
- Ship building
- Low temperature storage tanks
- Construction

SHIELDING GAS

100% CO₂
Flow Rate: 40-50 CFH

DIAMETERS / PACKAGING

Diameter in (mm)	33 lb (15kg) Fiber Spool (Plastic Bag)
0.045 (1.1)	ED035419
0.052 (1.3)	ED035420

MECHANICAL PROPERTIES⁽¹⁾

	Yield Strength ⁽²⁾ MPa (ksi)	Tensile Strength MPa (ksi)	Elongation (%)	Charpy V-Notch J (ft-lbf)	
				-40°C [-40°F]	-51°C [-60°F]
Requirements AWS A5.29 E111T1-K3C-JH4 As-Welded with 100% CO ₂	675 (98) min	760-895 (110-130)	15 min	27 (20) min	-
Typical Results⁽³⁾ As-Welded with 100% CO ₂	735-745 (107-108)	780-790 (113-115)	19-20	67-70 (49-52)	62-66 (46-48)
Stress Relieved with 100% CO ₂ for 1 hr @ 620°C (1150°F)	680-725 (99-105)	740-780 (107-113)	20-25	67-70 (49-52)	-

⁽¹⁾ Typical all weld metal. ⁽²⁾ Measure with 0.2% offset. ⁽³⁾ See test results disclaimer

DEPOSIT COMPOSITION⁽¹⁾

	%C	%Mn	%Si	%S	%P	%Ni
Requirements AWS A5.29 E111T1-K3C-JH4	0.15 max	0.75-2.25	0.80 max	0.030 max	0.030 max	1.25-2.60
Typical Results⁽²⁾ As-Welded with 100% CO ₂	0.05-0.07	1.59-1.73	0.25-0.28	0.007-0.011	0.008-0.011	2.41-2.50
	%Cr	%Mo	%V	%B	Diffusible Hydrogen (mL/100g weld deposit)	
Requirements AWS A5.29 E111T1-K3C-JH4	0.15 max	0.25-0.65	0.05 max	Not Specified	4.0 max	
Typical Results⁽³⁾ As-Welded with 100% CO ₂	0.04-0.12	0.41-0.49	0.00-0.01	0.003-0.004	1-3	

TYPICAL OPERATING PROCEDURES

Diameter, Polarity Shielding Gas	CTWD ⁽⁴⁾ mm (in)	Wire Feed Speed m/min (in/min)	Voltage (volts)	Approx. Current (amps)	Melt-Off Rate kg/hr (lb/hr)	Deposition Rate kg/hr (lb/hr)	Efficiency (%)
0.045 in (1.1 mm), DC+	19 (3/4)	4.4 (175)	25 - 29	130	1.9 (4.1)	1.7 (3.7)	89-90
	19 (3/4)	6.4 (250)	27 - 31	170	2.6 (5.8)	2.4 (5.2)	
	19 (3/4)	7.6 (300)	28 - 32	195	3.2 (7.0)	2.8 (6.2)	
	19 (3/4)	8.9 (350)	28 - 32	220	3.7 (8.1)	3.3 (7.2)	
	25 (1)	10.2 (400)	28 - 32	225	4.2 (9.2)	3.7 (8.2)	
	25 (1)	11.4 (450)	29 - 33	245	4.7 (10.4)	4.2 (9.2)	
	25 (1)	12.7 (500)	30 - 34	265	5.2 (11.5)	4.6 (10.2)	
0.052 in (1.3 mm), DC+	19 (3/4)	3.8 (150)	26 - 30	160	2.1 (4.6)	1.7 (3.8)	82-84
	19 (3/4)	4.4 (175)	26 - 30	180	2.4 (5.4)	2.0 (4.5)	
	19 (3/4)	5.1 (200)	27 - 31	200	2.8 (6.2)	2.3 (5.1)	
	19 (3/4)	5.7 (225)	27 - 31	220	3.2 (7.0)	2.6 (5.8)	
	19 (3/4)	7.0 (275)	28 - 32	255	3.9 (8.5)	3.2 (7.1)	
	25 (1)	7.6 (300)	28 - 32	230	4.2 (9.3)	3.5 (7.8)	
	25 (1)	8.3 (325)	28 - 32	245	4.6 (10.1)	3.8 (8.4)	
	25 (1)	8.9 (350)	29 - 33	255	4.9 (10.9)	4.1 (9.1)	

⁽¹⁾ Typical all weld metal. ⁽²⁾ Measure with 0.2% offset. ⁽³⁾ See test results disclaimer. ⁽⁴⁾ To estimate ESO, subtract 1/4 in (6.0 mm) from CTWD.

ULTRACORE® 111K3M-H PLUS

Low Alloy, All Positions · AWS E111T1-K3M-JH4

KEY FEATURES

- Innovative design capable of superior toughness at -60°F in both the as-welded and stress-relieved conditions
- Designed for welding with 75-80% Argon/ Balance CO₂ shielding gas
- H4 diffusible hydrogen levels
- Q2 Lot® - Certificate showing actual deposit chemistry and mechanical properties per lot available online
- ProTech® foil bag packaging

WELDING POSITIONS

All

CONFORMANCES

- AWS A5:** E111T1-K3M-JH4
CWB/CSA W48: E761T1-M21A5-K3-H4 [E761T1-K3M-JH4]

TYPICAL APPLICATIONS

- Offshore drilling rigs
- Low temperature storage tanks
- Ship building
- Construction

SHIELDING GAS

75-80% Argon / Balance CO₂
 Flow Rate: 40-50 CFH

DIAMETERS / PACKAGING

Diameter in (mm)	33 lb (15 kg) Fiber Spool (Plastic Bag)
0.045 (1.1)	ED035417
0.052 (1.3)	ED035418

MECHANICAL PROPERTIES⁽¹⁾

	Yield Strength ⁽²⁾ MPa (ksi)	Tensile Strength MPa (ksi)	Elongation (%)	Charpy V-Notch J (ft-lbf)	
				-40°C (-40°F)	-51°C (-60°F)
Requirements AWS A5.29 E111T1-K3M-JH4 As-Welded with 75% Ar / 25% CO ₂	675 (98) min	760-895 (110-130)	15 min	27 (20) min	-
Typical Results⁽³⁾ As-Welded with 75% Argon / 25% CO ₂	725-745 (105-108)	770-785 (112-114)	19-20	50-54 (37-40)	47-52 (34-39)
Stress Relieved with 75% Ar / 25% CO ₂ for 1 hr @ 620°C (1150°F)	705-720 (102-105)	765-775 (110-112)	21-22	50-54 (37-40)	-

⁽¹⁾ Typical all weld metal. ⁽²⁾ Measure with 0.2% offset. ⁽³⁾ See test results disclaimer

DEPOSIT COMPOSITION⁽¹⁾

	%C	%Mn	%Si	%S	%P	%Ni
Requirements AWS A5.29 E111T1-K3M-JH4	0.15 max	0.75-2.25	0.80 max	0.030 max	0.030 max	1.25-2.60
Typical Results⁽²⁾ As-Welded with 75% Argon / 25% CO ₂	0.05-0.06	1.59-1.84	0.27-0.34	0.007	0.010-0.011	2.31-2.60
	%Cr	%Mo	%V	%B	Diffusible Hydrogen (mL/100g weld deposit)	
Requirements AWS A5.29 E111T1-K3M-JH4	0.15 max	0.25-0.65	0.05 max	Not Specified	4.0 max	
Typical Results⁽²⁾ As-Welded with 75% Argon / 25% CO ₂	0.04-0.07	0.45-0.51	0.00	0.004-0.005	1-3	

TYPICAL OPERATING PROCEDURES

Diameter, Polarity Shielding Gas	CTWD ⁽⁴⁾ mm (in)	Wire Feed Speed m/min (in/min)	Voltage (volts)	Approx. Current (amps)	Melt-Off Rate kg/hr (lb/hr)	Deposition Rate kg/hr (lb/hr)	Efficiency (%)
0.045 in (1.1 mm), DC+	19 (3/4)	4.4 (175)	24 - 28	120	1.8 (3.9)	1.5 (3.4)	85-87
	19 (3/4)	6.4 (250)	25 - 29	140	2.5 (5.6)	2.2 (4.8)	
	19 (3/4)	7.6 (300)	26 - 30	155	3.1 (6.8)	2.6 (5.8)	
	19 (3/4)	8.9 (350)	27 - 31	170	3.6 (7.9)	3.1 (6.8)	
	25 (1)	10.2 (400)	28 - 32	185	4.1 (9.0)	3.5 (7.8)	
	25 (1)	11.4 (450)	28 - 32	200	4.6 (10.1)	4.0 (8.8)	
	25 (1)	12.7 (500)	29 - 33	220	5.1 (11.3)	4.4 (9.8)	
0.052 in (1.3 mm), DC+	19 (3/4)	3.8 (150)	26 - 29	160	2.1 (4.6)	1.7 (3.8)	82-84
	19 (3/4)	4.4 (175)	26 - 29	180	2.4 (5.4)	2.0 (4.5)	
	19 (3/4)	5.1 (200)	27 - 30	200	2.8 (6.2)	2.3 (5.1)	
	19 (3/4)	5.7 (225)	27 - 30	220	3.2 (7.0)	2.6 (5.8)	
	19 (3/4)	7.0 (275)	28 - 31	255	3.9 (8.5)	3.2 (7.1)	
	25 (1)	7.6 (300)	28 - 31	230	4.2 (9.3)	3.5 (7.8)	
	25 (1)	8.3 (325)	28 - 31	245	4.6 (10.1)	3.8 (8.4)	
25 (1)	8.9 (350)	29 - 32	255	4.9 (10.9)	4.1 (9.1)		

⁽¹⁾ Typical all weld metal. ⁽²⁾ Measure with 0.2% offset. ⁽³⁾ See test results disclaimer ⁽⁴⁾ To estimate ESO, subtract 1/4 in (6.0 mm) from CTWD.

ULTRACORE® 121K3M-H PLUS

Low Alloy, All Positions • AWS E121T1-GM-H4

KEY FEATURES

- Innovative design capable of superior toughness at -60°F in both the as-welded and stress-relieved conditions
- Designed for welding with 75-80% Argon/ Balance CO₂ shielding gas
- H4 diffusible hydrogen levels
- Q2 Lot® - Certificate showing actual deposit chemistry and mechanical properties per lot available online
- ProTech® foil bag packaging

CONFORMANCES

AWS A5: E121T1-GM-H4

TYPICAL APPLICATIONS

- Offshore drilling rigs
- Low temperature storage tanks
- Ship building
- Construction

WELDING POSITIONS

All

SHIELDING GAS

75-80% Argon / Balance CO₂
Flow Rate: 40-50 CFH

DIAMETERS / PACKAGING

Diameter in (mm)	33 lb (15 kg) Fiber Spool (Plastic Bag)
0.045 (1.1)	ED035423
0.052 (1.3)	ED035424

MECHANICAL PROPERTIES⁽¹⁾

	Yield Strength ⁽²⁾ MPa (ksi)	Tensile Strength MPa (ksi)	Elongation (%)	Charpy V-Notch J (ft-lbf)	
				-40°C (-40°F)	-51°C (-60°F)
Requirements AWS A5.29 E121T1-GM-H4 As-Welded with 75% Ar / 25% CO ₂	745 (108) min	825-965 (120-140)	14 min	-	-
Typical Results⁽³⁾ As-Welded with 75% Argon / 25% CO ₂	815-840 (118-122)	850-875 (123-127)	17-18	65-67 (48-50)	59-61 (44-45)
Stress Relieved with 75% Ar / 25% CO ₂ for 1 hr @ 620°C (1150°F)	745-765 (108-111)	805-820 (116-119)	18-23	65-67 (48-50)	-

⁽¹⁾ Typical all weld metal. ⁽²⁾ Measure with 0.2% offset. ⁽³⁾ See test results disclaimer

DEPOSIT COMPOSITION⁽¹⁾

	%C	%Mn	%Si	%S	%P	%Ni
Requirements AWS A5.29 E121T1-GM-H4	Not Specified	0.50 ⁽⁴⁾	1.00 max	0.030 max	0.030 max	0.50 ⁽⁴⁾
Typical Results⁽³⁾ As-Welded with 75% Argon / 25% CO ₂	0.06-0.07	1.61-1.80	0.26-0.35	0.007-0.012	0.010-0.011	2.21-2.46
	%Cr	%Mo	%V	%B	Diffusible Hydrogen (mL/100g weld deposit)	
Requirements AWS A5.29 E121T1-GM-H4	0.30 ⁽⁴⁾	0.20 ⁽⁴⁾	0.10 ⁽⁴⁾	Not Specified	4.0 max	
Typical Results⁽³⁾ As-Welded with 75% Argon / 25% CO ₂	0.04-0.07	0.58- 0.65	0.00	0.004-0.005	1-3	

TYPICAL OPERATING PROCEDURES

Diameter, Polarity Shielding Gas	CTWD ⁽²⁾ mm (in)	Wire Feed Speed m/min (in/min)	Voltage (volts)	Approx. Current (amps)	Melt-Off Rate kg/hr (lb/hr)	Deposition Rate kg/hr (lb/hr)	Efficiency (%)
0.045 in (1.1 mm), DC+	19 (3/4)	4.4 (175)	24 - 28	120	1.8 (3.9)	1.5 (3.4)	85-87
	19 (3/4)	6.4 (250)	25 - 29	140	2.5 (5.6)	2.2 (4.8)	
	19 (3/4)	7.6 (300)	26 - 30	155	3.1 (6.8)	2.6 (5.8)	
	19 (3/4)	8.9 (350)	27 - 31	170	3.6 (7.9)	3.1 (6.8)	
	25 (1)	10.2 (400)	28 - 32	185	4.1 (9.0)	3.5 (7.8)	
	25 (1)	11.4 (450)	28 - 32	200	4.6 (10.1)	4.0 (8.8)	
	25 (1)	12.7 (500)	29 - 33	220	5.1 (11.3)	4.4 (9.8)	
0.052 in (1.3 mm), DC+	19 (3/4)	3.8 (150)	26 - 29	160	2.1 (4.6)	1.7 (3.8)	82-84
	19 (3/4)	4.4 (175)	26 - 29	180	2.4 (5.4)	2.0 (4.5)	
	19 (3/4)	5.1 (200)	27 - 30	200	2.8 (6.2)	2.3 (5.1)	
	19 (3/4)	5.7 (225)	27 - 30	220	3.2 (7.0)	2.6 (5.8)	
	19 (3/4)	7.0 (275)	28 - 31	255	3.9 (8.5)	3.2 (7.1)	
	25 (1)	7.6 (300)	28 - 31	230	4.2 (9.3)	3.5 (7.8)	
	25 (1)	8.3 (325)	28 - 31	245	4.6 (10.1)	3.8 (8.4)	
25 (1)	8.9 (350)	29 - 32	255	4.9 (10.9)	4.1 (9.1)		

⁽¹⁾ Typical all weld metal. ⁽²⁾ Measure with 0.2% offset. ⁽³⁾ See test results disclaimer

⁽⁴⁾ In order to meet the requirements of the G group, the undiluted weld metal shall have not less than the minimum specified for one or mor eof the elements listed.

⁽⁵⁾ To estimate ESO, subtract 1/4 in (6.0 mm) from CTWD.

CORMET™ 5

Low Alloy, All Position · AWS E81T1-B6C/M

KEY FEATURES

- Designed for high strength and improved corrosion resistance with hot hydrogen gas, super-heated steam, and Sulphur crude oils
- Smooth arc performance in all positions

WELDING POSITIONS

All

SHIELDING GAS

80% Argon / 20% CO₂
Flow Rate: 40-50 CFH

CONFORMANCES

AWS 5.29 E81T1-B6C/M

TYPICAL APPLICATIONS

- Piping
- Steam Generating Power Plant
- Pressure Vessels
- Oil Refineries

DIAMETERS / PACKAGING

Diameter mm (in)	15 kg (33.1 lb) Spool
1.2 (0.045)	CM5-12

MECHANICAL PROPERTIES⁽¹⁾

	Yield Strength ⁽²⁾ MPa (ksi)	Tensile Strength MPa (ksi)	Elongation %
Requirements AWS E81T1-B6C/M	470 (68)min	550 (80) min	19 min
Typical Results⁽³⁾ As-Welded	600 (87)	690 (100)	22

DEPOSIT COMPOSITION⁽¹⁾

	%C	%Mn	%Si	%S	%P
Requirements AWS E81T1-B6C/M	0.05-0.10	1.20 max	0.50 max	0.030 max	0.030 max
Typical Results⁽³⁾	0.06	0.8	0.3	0.01	0.01
	%Cr	%Ni	%Mo	%Cu	
Requirements AWS E81T1-B6C/M	4.0-6.0	0.40 max	0.45-0.65	0.3 max	
Typical Results⁽³⁾	5	0.01	0.5	0.05	

TYPICAL OPERATING PROCEDURES

Diameter mm (in)	Polarity	Amp-Volt Range	Typical	Stickout mm (in)
1.2 (0.045)	DC+	160-260A / 24-30V	25V	15-25 (5/8-1)

⁽¹⁾Typical all weld metal ⁽²⁾ Measured with 0.2% offset ⁽³⁾ See test results disclaimer ⁽⁴⁾ Preferred polarity is listed first.

ULTRACORE[®] 80Ni1C

Low Alloy, Flat & Horizontal · AWS E80T1-Ni1C-JH8

KEY FEATURES

- High deposition in the flat and horizontal positions
- Excellent operator appeal and slag detachability
- Designed for welding with 100% CO₂ shielding gas
- ProTech[®] foil bag packaging

WELDING POSITIONS

Flat & Horizontal

SHIELDING GAS

100% CO₂
Flow Rate: 40-55 CFH

CONFORMANCES

- AWS A5.29:** E80T1-M21A4-Ni1-H8
CWB/CSA: E550T1-C1A4-Ni1-H8, E80T1-C1A4-Ni1-H8
AWS D1.8: 5/64", 3/32"

TYPICAL APPLICATIONS

- Structural fabrication
- Heavy equipment
- Shipbuilding

DIAMETERS / PACKAGING

Diameter in (mm)	50 lb (22.7 kg) Coil	500 lb (227 kg) Speed-Feed [®] Drum
5/64 [2.0]	ED035766	ED036640
3/32 [2.4]	ED035767	ED036639

MECHANICAL PROPERTIES⁽¹⁾

	Yield Strength ⁽²⁾ MPa (ksi)	Tensile Strength MPa (ksi)	Elongation %	Charpy V-Notch J (ft-lbf) -40°C [-40°F]
Requirements⁽⁴⁾ AWS A5.29 E80T1-Ni1C-JH8	470 [68] min	550-690 [80-100]	19 min	27 [20] min
Typical Results⁽³⁾ As-Welded with 100% CO ₂	500-600 [80-87]	630-670 [91-97]	24-28	43-72 [32-53]

⁽¹⁾Typical all weld metal. ⁽²⁾Measured with 0.2% offset. ⁽³⁾See test results disclaimer ⁽⁴⁾As-Welded with 100% CO₂. ⁽⁵⁾To estimate ESO, subtract 1/4 in [6.0 mm] from CTWD.

DEPOSIT COMPOSITION⁽¹⁾

	%C	%Mn	%Si	%S	%P	%Ni
Requirements AWS A5.29 E80T1-Ni1C-JH8	0.12 max	1.50 max	0.80 max	0.03 max	0.03 max	0.80-1.10
Typical Results⁽²⁾ As-Welded with 100% CO ₂	0.04-0.07	1.32-1.45	0.52-0.59	0.006-0.008	0.013-0.016	0.81-1.03
	%Cr	%Mo	%V	%B	Diffusible Hydrogen (mL/100g weld deposit)	
Requirements AWS A5.29 E80T1-Ni1C-JH8	0.15 max	0.35 max	0.05 max	Not Specified	8.0 max	
Typical Results⁽²⁾ As-Welded with 100% CO ₂	0.04-0.09	0.01	0.02-0.03	0.003-0.005	3.4-5.6	

TYPICAL OPERATING PROCEDURES – Flat & Horizontal

Diameter, Polarity Shielding Gas	CTWD ⁽³⁾ mm (in)	Wire Feed Speed m/min (in/min)	Voltage (volts)	Approx. Current (amps)	Melt-Off Rate kg/hr (lb/hr)	Deposition Rate kg/hr (lb/hr)	Efficiency (%)
1/16 in (1.6 mm), DC+ 100% CO ₂	25 (1)	3.2 (125)	23-27	155	2.2 (4.8)	2.0 (4.4)	84 - 89
		6.4 (250)	25-29	250	4.5 (9.9)	4.0 (8.8)	
		9.5 (375)	28-32	325	6.8 (14.9)	6.0 (13.2)	
5/64 in (2.0 mm), DC+ 100% CO ₂	25 (1)	3.2 (125)	23-27	240	3.5 (7.8)	3.1 (6.8)	84 - 88
		5.7 (225)	25-29	350	6.4 (14.0)	5.5 (12.2)	
3/32 in (2.4 mm), DC+ 100% CO ₂	31 (1 1/4)	8.3 (325)	27-32	395	8.5 (18.6)	7.5 (16.4)	87 - 89
		3.2 (125)	27-32	320	5.4 (11.9)	4.7 (10.3)	
		5.1 (200)	28-33	450	8.6 (19.0)	7.6 (16.7)	
		6.4 (250)	31-37	580	13.1 (28.8)	11.4 (25.1)	

⁽¹⁾Typical all weld metal. ⁽²⁾Measured with 0.2% offset. ⁽³⁾See test results disclaimer ⁽⁴⁾As-Welded with 100% CO₂. ⁽⁵⁾To estimate ESO, subtract 1/4 in (6.0 mm) from CTWD.

ULTRACORE® 80Ni1M

Low Alloy, Flat & Horizontal · AWS E80T1-Ni1M-JH8

KEY FEATURES

- High deposition in the flat and horizontal positions
- Excellent operator appeal and slag detachability
- Designed for welding with 75-80% Argon / balance CO₂ shielding gas
- ProTech® foil bag packaging

WELDING POSITIONS

Flat & Horizontal

SHIELDING GAS

75-80% Argon / balance CO₂
Flow Rate: 40-55 CFH

CONFORMANCES

AWS A5.29: E80T1-Ni1M-JH8

TYPICAL APPLICATIONS

- Structural fabrication
- Heavy equipment
- Shipbuilding

DIAMETERS / PACKAGING

Diameter in (mm)	50 lb (22.7 kg) Coil	500 lb (227 kg) Speed-Feed® Drum
3/32 [2.4]	ED035770	ED036620

MECHANICAL PROPERTIES⁽¹⁾

	Yield Strength ⁽²⁾ MPa (ksi)	Tensile Strength MPa (ksi)	Elongation %	Charpy V-Notch J (ft-lbf) -40°C [-40°F]
Requirements⁽⁴⁾ AWS A5.29 E80T1-Ni1M-JH8	470 [68] min	550-690 [80-100]	19 min	27 [20] min
Typical Results⁽³⁾ As-Welded with 75% Ar / 25% CO ₂	585-595 [85-86]	630-650 [91-94]	27	50-75 [37-57]

⁽¹⁾Typical all weld metal. ⁽²⁾Measured with 0.2% offset. ⁽³⁾See test results disclaimer ⁽⁴⁾As-Welded with 100% CO₂. ⁽⁵⁾To estimate ESO, subtract 1/4 in [6.0 mm] from CTWD.

DEPOSIT COMPOSITION⁽¹⁾

	%C	%Mn	%Si	%S	%P	%Ni
Requirements AWS A5.29 E80T1-Ni1M-JH8	0.12 max	1.50 max	0.80 max	0.03 max	0.03 max	0.80-1.10
Typical Results⁽²⁾ As-Welded with 100% CO ₂	0.04-0.06	1.32-1.36	0.54-0.55	0.004-0.006	0.011-0.012	0.91-1.04
	%Cr	%Mo	%V	%B	Diffusible Hydrogen (mL/100g weld deposit)	
Requirements AWS A5.29 E80T1-Ni1M-JH8	0.15 max	0.35 max	05 max	Not Specified	8.0 max	
Typical Results⁽³⁾ As-Welded with 100% CO ₂	0.04-0.06	0.01	0.02	0.004-0.005	2.9-4.6	

TYPICAL OPERATING PROCEDURES – Flat & Horizontal

Diameter, Polarity Shielding Gas	CTWD ⁽⁴⁾ mm (in)	Wire Feed Speed m/min (in/min)	Voltage (volts)	Approx. Current (amps)	Melt-Off Rate kg/hr (lb/hr)	Deposition Rate kg/hr (lb/hr)	Efficiency (%)
3/32 in (2.4 mm), DC+ 75% Ar / 25% CO ₂	25 (1)	3.2 (125)	27-32	340	5.4 (11.9)	4.7 (10.3)	87 - 89
	31 (1 1/4)	5.1 (200)	27-32	465	8.6 (19.0)	7.6 (16.7)	
		6.4 (250)	30-36	620	13.1 (28.8)	11.4 (25.1)	

⁽¹⁾Typical all weld metal. ⁽²⁾Measured with 0.2% offset. ⁽³⁾See test results disclaimer ⁽⁴⁾As-Welded with 100% CO₂. ⁽⁵⁾To estimate ESO, subtract 1/4 in (6.0 mm) from CTWD.

SAW CONSUMABLES

SUBMERGED ARC



LINCOLNWELD® 760®

700 Series Active Flux · EN ISO 14174 – S A MS 1; EN ISO 14174 – S A CS 1; EN ISO 14174 - S A GS 1

KEY FEATURES

- Highly active flux for handling rust and mill scale
- Helps resist porosity caused by arc blow
- Slow freezing slag for good weld appearance
- Actual (Type 3.1) certificates for each lot of flux showing chemical composition, particle size and moisture level are available in the certificate center of lincolnelectric.com

PACKAGING

50 lb (22.7 kg) Plastic Bag

ED032799

TYPICAL APPLICATIONS

- Single pass welding of mild steel
- Flat fillet welds with constant voltage power source

RECOMMENDED WIRES

Mild Steel

Lincolnweld® L-50®, L-60, and L-61®

PRODUCT INFORMATION

Basicity Index: 0.8

Density: 1.2 g/cm³

FLUX COMPOSITION⁽¹⁾

	%SiO ₂	%MnO	%MgO	%CaF ₂	%Na ₂ O	%Al ₂ O ₃	%CaO	% Metal Alloys
Lincolnweld® 760®	47	33	17	5	2	2	1	6 max

AWS TEST RESULTS⁽¹⁾

Flux/Wire Combination	Weld Condition	Yield Strength ⁽²⁾ MPa (ksi)	Tensile Strength MPa (ksi)	Elongation [%]	Charpy V-Notch		AWS Classification (A5.17/A5.23)
					J (ft-lbf)	@ °C (°F)	
L-50®	As-welded	440 (64)	550 (80)	30	53 (39)	-18 (0)	F7A0-EM13K
L-60	As-welded	390 (57)	490 (71)	30	98 (72)	-29 (-20)	F6A2-EL12
L-61®	As-welded	410 (59)	530 (77)	28	69 (51)	-29 (-20)	F7A2-EM12K

⁽¹⁾See test results disclaimer ⁽²⁾Measured with 0.2% offset. NOTE: For the most up-to-date AWS certificates of conformance please visit www.lincolnelectric.com

LINCOLNWELD® 761®

700 Series Active Flux · EN ISO 14174 – S A MS 1; EN ISO 14174 – S A CS 1; EN ISO 14174 – S A GS 1

KEY FEATURES

- Manganese alloying and carbon reducing flux designed to provide superior crack resistance
- Slow freezing slag for a wide, flat weld
- Excellent resistance to cracking in single pass applications
- Actual (Type 3.1) certificates for each lot of flux showing chemical composition, particle size and moisture level are available in the certificate center of lincolnelectric.com

PACKAGING

50 lb (22.7 kg) Plastic Bag

ED032765

TYPICAL APPLICATIONS

- Single pass welding of mild steel
- Large fillets with constant current power sources

RECOMMENDED WIRES

Mild Steel

Lincolnweld® L-50®, L-60, and L-61®

Low Alloy Steel

Lincolnweld® L-70

PRODUCT INFORMATION

Basicity Index: 0.8

Density: 1.2 g/cm³

FLUX COMPOSITION⁽¹⁾

	%SiO ₂	%MnO	%MgO	%CaF ₂	%Na ₂ O	%Al ₂ O ₃	%TiO ₂	%FeO	% Metal Alloys
Lincolnweld® 761®	45	19	22	5	2	2	2	1	6 max

AWS TEST RESULTS⁽¹⁾

Flux/Wire Combination	Weld Condition	Yield Strength ⁽²⁾ MPa (ksi)	Tensile Strength MPa (ksi)	Elongation (%)	Charpy V-Notch		AWS Classification (A5.17/A5.23)
					J (ft-lbf)	@ °C (°F)	
L-50®	As-welded	480 (69)	590 (85)	29	45 (33)	-29 (-20)	F7A2-EM13K-H8
L-60	As-welded	440 (64)	530 (75)	29	64 (47)	-29 (-20)	F7A2-EL12
L-61®	As-welded	480 (70)	590 (85)	28	54 (40)	-29 (-20)	F7A2-EM12K-H8
L-70	As-welded	550 (80)	640 (93)	24	58 (43)	-18 (0)	F9A0-EA1-G

⁽¹⁾See test results disclaimer ⁽²⁾Measured with 0.2% offset. NOTE: For the most up-to-date AWS certificates of conformance please visit www.lincolnelectric.com

LINCOLNWELD® 780®

700 Series Active Flux · EN ISO 14174 – S A AB 1; EN ISO 14174 – S A AR 1

KEY FEATURES

- Industry standard for submerged arc welding applications
- Fast freezing slag for easy removal and minimized spilling on circumferential welds
- Recommended for up to three passes when paired with Lincolnweld L-61
- Excellent bead shape and slag removal
- Good resistance to moisture contamination for reduced porosity
- Actual [Type 3.1] certificates for each lot of flux showing chemical composition, particle size and moisture level are available in the certificate center of lincolnelectric.com

PACKAGING

50 lb (22.7 kg) Bag	ED019586
550 lb (249.5 kg) Steel Drum	ED032007
3000 lb (1361 kg) Foil Lined Bulk Bag	ED033188

TYPICAL APPLICATIONS

- Single pass welding of mild steel
- Roundabouts with minimal spillage
- Horizontal position welding

RECOMMENDED WIRES

Mild Steel
Lincolnweld® L-50®, L-60 and L-61®

PRODUCT INFORMATION

Basicity Index: 0.7
Density: 1.4 g/cm³

FLUX COMPOSITION⁽¹⁾

	%SiO ₂	%MnO	%MgO	%CaF ₂	%Na ₂ O	%Al ₂ O ₃	%CaO	%TiO ₂	% Metal Alloys
Lincolnweld® 780®	9	16	2	11	2	45	1	9	6 max

AWS TEST RESULTS⁽¹⁾

Flux/Wire Combination	Weld Condition	Yield Strength ⁽²⁾ MPa (ksi)	Tensile Strength MPa (ksi)	Elongation (%)	Charpy V-Notch		AWS Classification (A5.17/A5.23)
					J (ft-lbf)	@ °C (°F)	
L-50®	As-welded	520 (75)	600 (87)	27	65 (48)	-18 (0)	F7A0-EM13K
L-60	As-welded	440 (64)	520 (76)	30	88 (65)	-18 (0)	F7A0-EL12-H8
L-61®	As-welded	530 (77)	600 (87)	27	46 (34)	-29 (-20)	F7A2-EM12K-H8

⁽¹⁾See test results disclaimer ⁽²⁾Measured with 0.2% offset. NOTE: For the most up-to-date AWS certificates of conformance please visit www.lincolnelectric.com

LINCOLNWELD® 781™

700 Series Active Flux • EN ISO 14174 – S A ZS 1

KEY FEATURES

- Features fast follow characteristics that allow for uniform welds at high speeds without undercut or voids
- Recommended for high speed, limited pass welding on clean plate and sheet steel
- Good wetting action
- Actual (Type 3.1) certificates for each lot of flux showing chemical composition, particle size and moisture level are available in the certificate center of lincolnelectric.com

PACKAGING

50 lb (22.7 kg) Bag

ED019587

TYPICAL APPLICATIONS

- Single pass welding – on clean plate and sheet metal up to 4.8 mm (3/16 in) in thickness
- Hot water tanks, metal buildings and other applications requiring high speed welds

RECOMMENDED WIRES

Mild Steel

Lincolnweld® L-50®, L-60, and L-61®

Low Alloy Steel

Lincolnweld® L-70

PRODUCT INFORMATION

Basicity Index: 0.8

Density: 1.5 g/cm³

FLUX COMPOSITION⁽¹⁾

	%SiO ₂	%MnO	%MgO	%CaF ₂	%Na ₂ O	%Al ₂ O ₃	%ZrO ₂	%TiO ₂	%CaO	% Metal Alloys
Lincolnweld® 781®	21	17	14	5	2	4	21	12	1	3 max

AWS TEST RESULTS⁽¹⁾

Flux/Wire Combination	Weld Condition	Yield Strength ⁽²⁾ MPa (ksi)	Tensile Strength MPa (ksi)	Elongation (%)	Charpy V-Notch		AWS Classification (A5.17/A5.23)
					J (ft-lbf)	@ °C (°F)	
L-50®	As-welded	530 (77)	610 (89)	29	38 (28)	-18 (0)	F7A0-EM13K
L-60	As-welded	460 (67)	550 (80)	29	42 (31)	-18 (0)	F7A0-EL12
L-61®	As-welded	530 (77)	610 (89)	28	31 (23)	-18 (0)	F7A0-EM12K
L-70	As-welded	590 (85)	660 (96)	25	35 (26)	-18 (0)	F9A0-EA1-G

⁽¹⁾See test results disclaimer ⁽²⁾Measured with 0.2% offset. NOTE: For the most up-to-date AWS certificates of conformance please visit www.lincolnelectric.com

LINCOLNWELD® 822™

800 Series Neutral Flux · EN ISO 14174 – S A FB 1

KEY FEATURES

- Designed for chrome-moly applications with Lincolnweld® LA-92 and LA-93 submerged arc wires
- Enables high Charpy V-Notch toughness at temperatures below -40°C (-40°F)
- Step-cooling tests show high resistance to temper embrittlement when welded with Lincolnweld LA-92 and LA-93
- Low Bruscato factor (X<10) when welded with Lincolnweld LA-92 and LA-93
- Certificate of Conformance available with LA-71 to create end user convenience with one flux
- Actual (Type 3.1) certificates for each lot of flux showing chemical composition, particle size and moisture level are available in the certificate center of lincolnelectric.com

TYPICAL APPLICATIONS

- Power Generation
- Process Chemical
- Pressure Vessels

RECOMMENDED WIRES

Mild Steel
Lincolnweld® LA-71™

Low Alloy Steel
Lincolnweld® LA-92, LA-93

PRODUCT INFORMATION

Basicity Index: 2.6
Density: 1.3

PACKAGING

50 lb (22.7 kg) Plastic Bag

ED036223

FLUX COMPOSITION⁽¹⁾

	% SiO ₂	% MnO	% MgO	% CaF ₂	% Na ₂ O	% Al ₂ O ₃	% CaO	% Metal Alloys
Lincolnweld® 822™	15	2	32	21	3	18	5	3 max

AWS TEST RESULTS⁽¹⁾

Flux/Wire Combination	Weld Condition	Yield Strength ⁽²⁾ MPa (ksi)	Tensile Strength MPa (ksi)	Elongation [%]	Charpy V-Notch		AWS Classification (A5.17/A5.23)
					J (ft-lbf)	@ °C (°F)	
LA-92	As-welded	640 (92)	710 (102)	24	95 (70)	-29 [-20]	F9A2-EB2R-B2R-H4
LA-92	Stress-relieved ⁽³⁾	480 (70)	580 (85)	29	200 (148)	-40 [-40]	F8P4-EB2R-B2R-H4
LA-93	As-welded	760 (110)	880 (128)	20	35 (26)	-18 (0)	F11A0-EB3R-B3R-H4
LA-93	Stress-relieved ⁽³⁾	550 (80)	660 (96)	23	156 (115)	-40 [-40]	F9P4-EB3R-B3R-H4
LA-71	As-welded	480 (70)	580 (85)	27	151 (111)	-62 [-80]	F7A8-EM14K-H4
LA-71	Stress-relieved ⁽⁴⁾	430 (63)	560 (81)	31	127 (93)	-62 [-80]	F7P8-EM14K-H4

⁽¹⁾See test results disclaimer. ⁽²⁾Measured with 0.2% offset. ⁽³⁾Stress-relieved for 1 hour at 691°C (1275°F). ⁽⁴⁾Stress-relieved for 1 hour at 620°C (1150°F).

LINCOLNWELD® 842-H™

800 Series Neutral Flux · EN ISO 14174 – S A FB 1 55 AC H4

KEY FEATURES

- Less than 4 mL of diffusible hydrogen per 100 g of deposited weld metal in DC+ polarity
- Consistent and low temperature impact and CTOD toughness
- Capable of welding on multiple arcs
- Excellent slag detachment
- Superior flux particle strength for use in central recovery system
- Actual (Type 3.1) certificates for each lot of flux showing chemical composition, particle size and moisture level are available in the certificate center of lincolnelectric.com

PACKAGING

50 lb (22.7 kg) Hermetically Sealed Pail

ED034371

TYPICAL APPLICATIONS

- Semi-submersible production and exploration platforms
- Fixed, jacket and work platforms
- Compliant towers
- Topside structural applications
- SPAR, FPSO, and FSO applications
- Jack up rigs

RECOMMENDED WIRES

Mild Steel Electrode

Lincolnweld® L-S3

Low Alloy Electrodes

Lincolnweld® LA-85, LA-84, LAC-690

PRODUCT INFORMATION

Basicity Index: 2.3

Density: 1.1 g/cm³

FLUX COMPOSITION⁽¹⁾

	%SiO ₂	%MnO	%MgO	%CaF ₂	%Na ₂ O	%Al ₂ O ₃	%CaO	% Metal Alloys
Lincolnweld® 842-H™	15	2	32	21	2	21	4	1 max

AWS TEST RESULTS⁽¹⁾

Flux/Wire Combination	Weld Condition	Yield Strength ⁽²⁾ MPa (ksi)	Tensile Strength MPa (ksi)	Elongation [%]	Charpy V-Notch		AWS Classification [A5.17/A5.23]
					J [ft.-lbf]	@ °C [°F]	
L-61	As-Welded	440 (64)	520 (76)	33	318 (234)	-51 (-60)	F7A6-EM12K-H4
	Stress Relieved ⁽³⁾	370 (53)	480 (70)	38	335 (247)	-62 (-80)	F6P8-EM12K-H4
L-S3	As-Welded	490 (72)	580 (84)	30	187 (138)	-62 (-80)	F7A8-EH12K-H4
	Stress Relieved ⁽³⁾	420 (61)	550 (79)	32	161 (119)	-62 (-80)	F7P8-EH12K-H4
LA-85	As-Welded	540 (78)	610 (89)	28	171 (126)	-62 (-80)	F8A8-ENi5-Ni5-H4
	Stress Relieved ⁽³⁾	510 (74)	600 (87)	30	149 (110)	-62 (-80)	F8P8-ENi5-Ni5-H4
LA-84	As-Welded	640 (93)	720 (104)	25	140 (103)	-62 (-80)	F9A8-EF3-F3-H4
	Stress Relieved ⁽³⁾	610 (89)	700 (101)	28	83 (61)	-62 (-80)	F9P8-EF3-F3-H4
LAC-690	As-Welded	700 (102)	790 (115)	23	139 (95)	-73 (-100)	F10A10-ECF5-F5-H4

⁽¹⁾ See test results disclaimer ⁽²⁾ Measured with 0.2% offset. ⁽³⁾ Stress-relieved for 1 hour at 621°C (1150°F)NOTE: For the most up-to-date AWS certificates of conformance please visit www.lincolnelectric.com

LINCOLNWELD® 860®

800 Series Neutral Flux · EN ISO 14174 – S A AB 1

KEY FEATURES

- Industry standard for submerged arc welding applications
- Excellent operating characteristics in a variety of general welding applications
- Capable of producing weld deposits with impact toughness exceeding 27 J (20 ft-lbf) at -40°C (-40°F) with Lincolnweld® L-61®
- Actual (Type 3.1) certificates for each lot of flux showing chemical composition, particle size and moisture level are available in the certificate center of lincolnelectric.com

PACKAGING

50 lb (22.7 kg) Bag

ED019589, ED030840*

*Tested Material

TYPICAL APPLICATIONS

- AASHTO Fracture Critical applications with Lincolnweld® L-61® wire
- Pipe and other double ending applications
- General purpose structural and multiple pass welds
- Storage tanks using L-61® or LA-85

RECOMMENDED WIRES

Mild Steel

Lincolnweld® L-61®, LA-71, L-50®, L-60, L-56®, L-S3

Low Alloy Steel

Lincolnweld® L-70, LA-75, LA-85

PRODUCT INFORMATION

Basicity Index: 1.1

Density: 1.4 g/cm³

FLUX COMPOSITION⁽¹⁾

	%SiO ₂	%MnO	%MgO	%CaF ₂	%Na ₂ O	%Al ₂ O ₃	%CaO	%TiO ₂	% Metal Alloys
Lincolnweld® 860®	19	11	17	12	2	32	2	2	3 max

AWS TEST RESULTS⁽¹⁾

Flux/Wire Combination	Weld Condition	Yield Strength ⁽²⁾ MPa (ksi)	Tensile Strength MPa (ksi)	Elongation (%)	Charpy V-Notch		AWS Classification (A5.17/A5.23)
					J (ft-lbf)	@ °C (°F)	
L-50®	As-welded	430 (62)	520 (75)	30	84 (62)	-29 (-20)	F7A2-EM13K-H4
L-56®	As-welded	470 (68)	590 (86)	28	61 (45)	-29 (-20)	F7A2-EH11K-H4
L-56®	Stress-relieved ⁽³⁾	440 (64)	570 (82)	29	80 (59)	-29 (-20)	F7P2-EH11K-H4
L-60	As-welded	370 (54)	450 (65)	34	138 (102)	-29 (-20)	F6A2-EL12-H4
L-61®	As-welded	410 (59)	500 (72)	31	58 (43)	-40 (-40)	F7A4-EM12K-H8
L-61®	Stress-relieved ⁽³⁾	340 (49)	440 (64)	37	222 (164)	-46 (-50)	F6P5-EM12K-H8
L-S3	As-welded	500 (73)	590 (86)	28	52 (38)	-29 (-20)	F7A2-EH12K-H4
LA-71	As-welded	450 (65)	540 (78)	30	110 (81)	-29 (-20)	F7A2-EM14K-H4
LA-71	Stress-relieved ⁽³⁾	400 (58)	520 (75)	32	119 (88)	-29 (-20)	F7P2-EM14K-H4
L-70	As-welded	450 (65)	550 (80)	28	54 (40)	-29 (-20)	F7A2-EA1-A2-H4
L-70	Stress-relieved ⁽³⁾	430 (62)	520 (76)	31	47 (35)	-29 (-20)	F7P2-EA1-A2-H4
LA-75	As-welded	460 (66)	550 (80)	32	107 (79)	-29 (-20)	F7A2-ENiK-Ni-H4
LA-75	Stress-relieved ⁽³⁾	410 (60)	540 (79)	30	99 (73)	-29 (-20)	F7P2-ENiK-Ni-H4
LA-85	As-welded	520 (75)	600 (87)	26	38 (28)	-40 (-40)	F8A4-ENi5-Ni5-H4
L-S3	As-welded	430 (63)	530 (77)	32	158 (116)	-29C (-20F)	F7A2-EH12K-H4

⁽¹⁾See test results disclaimer ⁽²⁾Measured with 0.2% offset. ⁽³⁾Stress-relieved for 1 hour at 621°C (1150°F).

NOTE: For the most up-to-date AWS certificates of conformance please visit www.lincolnelectric.com

LINCOLNWELD® 865™

800 Series Neutral Flux · EN ISO 14174 – S A AB 1; EN ISO 14174 – S A AR 1

KEY FEATURES

- General purpose flux designed to weld butt joints and flat and horizontal fillets
- When used with Lincolnweld® L-50® or L-61®, it is capable of producing 480 MPa (70 ksi) tensile strength after stress relief
- Small loss of strength when used in the stress-relieved condition
- Actual (Type 3.1) certificates for each lot of flux showing chemical composition, particle size and moisture level are available in the certificate center of lincolnelectric.com

PACKAGING

50 lb (22.7 kg) Bag

EDS27857

TYPICAL APPLICATIONS

- Butt joints and flat and horizontal fillets
- Pair with Lincolnweld® L-61® on A516 steels

RECOMMENDED WIRES

Mild Steel

Lincolnweld® L-50®, L-61®, LA-71

Low Alloy Steel

Lincolnweld® LA-75

PRODUCT INFORMATION

Basicity Index: 1.0

Density: 1.3 g/cm³

FLUX COMPOSITION⁽¹⁾

	%SiO ₂	%MnO	%MgO	%CaF ₂	%Na ₂ O	%Al ₂ O ₃	%TiO ₂	%Metal Alloys
Lincolnweld® 865™	11	1	14	19	2	37	12	3 max

AWS TEST RESULTS⁽¹⁾

Flux/Wire Combination	Weld Condition	Yield Strength ⁽²⁾ MPa (ksi)	Tensile strength MPa (ksi)	Elongation (%)	Charpy V-Notch		AWS Classification (A5.17/A5.23)
					J (ft-lbf)	@ °C (°F)	
L-50®	As-welded	500 (72)	580 (84)	27	53 (39)	-29 (-20)	F7A2-EM13K-H8
L-50®	Stress-relieved ⁽³⁾	440 (64)	550 (80)	30	28 (21)	-46 (-50)	F7P5-EM13K-H8
L-61®	As-welded	480 (70)	570 (83)	22	85 (63)	-29 (-20)	F7A2-EM12K-H8
L-61®	Stress-relieved ⁽³⁾	450 (65)	550 (80)	30	117 (86)	-29 (-20)	F7P2-EM12K-H8
LA-71	As-welded	540 (78)	630 (91)	26	73 (54)	-29 (-20)	F7A2-EM14K-H8
LA-75	As-welded	520 (76)	600 (87)	23	77 (57)	-29 (-20)	F8A2-ENi1K-G-H8
LA-75	Stress-relieved ⁽³⁾	500 (73)	610 (88)	27	79 (58)	-29 (-20)	F8P2-ENi1K-G-H8

⁽¹⁾See test results disclaimer ⁽²⁾Measured with 0.2% offset. ⁽³⁾Stress-relieved for 1 hour at 621°C (1150°F).

NOTE: For the most up-to-date AWS certificates of conformance please visit www.lincolnelectric.com

LINCOLNWELD® 880™

800 Series Neutral Flux

KEY FEATURES

- Can be used for both joining and hardfacing welding
- Optimal bead appearance when used with solid low alloy steel electrodes with a minimum of 0.20% silicon
- Use with both solid and flux cored wires
- Actual (Type 3.1) certificates for each lot of flux showing chemical composition, particle size and moisture level are available in the certificate center of lincolnelectric.com

PACKAGING

50 lb (22.7 kg) Bag

550 lb (249.5 kg) Steel Drum

ED027866ED028322

TYPICAL APPLICATIONS

- Applications requiring smooth bead appearance
- Hardfacing applications

RECOMMENDED WIRES

Low Alloy Steel

Lincolnweld® LA-75, LA-90, LA-100, LAC-B2,

LAC-M2, LAC-Ni2

PRODUCT INFORMATION

Basicity Index: 2.0

Density: 1.4 g/cm³

FLUX COMPOSITION⁽¹⁾

	%SiO ₂	%MgO	%CaF ₂	%Na ₂ O	%Al ₂ O ₃	%CaO	%ZrO ₂	% Metal Alloys
Lincolnweld® 880™	17	27	27	2	16	2	7	5 max

AWS TEST RESULTS⁽¹⁾

Flux/Wire Combination	Weld Condition	Yield Strength ⁽²⁾ MPa (ksi)	Tensile Strength MPa (ksi)	Elongation (%)	Charpy V-Notch		AWS Classification (A5.17/A5.23)
					J (ft-lbf)	@ °C (°F)	
LA-75	As-welded	430 (62)	530 (77)	30	98 (72)	-62 [-80]	F7A8-ENiK-Ni1-H8
LA-90	As-welded	540 (79)	640 (93)	28	61 (45)	-40 [-40]	F8A4-EA3K-A4-H8
LA-100	As-welded	630 (92)	700 (101)	28	53 (39)	-40 [-40]	F9A4-EM2-M2-H8
LAC-B2	Stress relieved ⁽⁴⁾	480 (70)	590 (85)	26	135 (100)	-29 [-20]	F8P2-ECB2-B2-H8

⁽¹⁾See test results disclaimer ⁽²⁾Measured with 0.2% offset. ⁽³⁾Stress-relieved for 1 hour at 621°C (1150°F). ⁽⁴⁾Stress-relieved for 1 hour at 691°C (1275°F).

NOTE: For the most up-to-date AWS certificates of conformance please visit www.lincolnelectric.com

LINCOLNWELD® 880M®

800 Series Neutral Flux · EN ISO 14174 – S A FB 1

KEY FEATURES

- A basic flux which features industry proven results in multiple pass applications
- Good deep groove slag removal
- Excellent choice for single arc AC submerged arc welding
- Actual (Type 3.1) certificates for each lot of flux showing chemical composition, particle size and moisture level are available in the certificate center of lincolnelectric.com

PACKAGING

50 lb [22.7 kg] Plastic Bag

ED031853

TYPICAL APPLICATIONS

- Tandem arc applications for offshore fabrication
- Jobs requiring 480 MPa [70 ksi] tensile strength after stress relief when used with L-56°, L-S3, or LA-71

RECOMMENDED WIRES

Mild Steel

Lincolnweld® L-50°, L-56°, LA-71, L-S3

Low Alloy Steel

Lincolnweld® LA-75, LA-85, LA-90, LA-92, LA-93, LA-100, LAC-B2, LAC-Ni2

PRODUCT INFORMATION

Basicity Index: 3.3

Density: 1.2 g/cm³

FLUX COMPOSITION⁽¹⁾

	%SiO ₂	%MnO	%MgO	%CaF ₂	%Na ₂ O	%Al ₂ O ₃	%CaO	%K ₂ O	% Metal Alloys
Lincolnweld® 880M®	12	1	29	29	1	18	8	1	1 max

AWS TEST RESULTS⁽¹⁾

Flux/Wire Combination	Weld Condition	Yield Strength ⁽²⁾ MPa (ksi)	Tensile Strength MPa (ksi)	Elongation [%]	Charpy V-Notch		AWS Classification (A5.17/A5.23)
					J [ft-lbf]	@ °C [°F]	
L-50°	As-welded	410 [59]	510 [74]	32	263 [194]	-62 [-80]	F7A8-EM13K-H8
L-56°	As-welded	480 [69]	580 [85]	31	121 [89]	-51 [-60]	F7A6-EH11K-H8
L-56°	Stress-relieved ⁽³⁾	400 [58]	540 [78]	32	158 [116]	-51 [-60]	F7P6-EH11K-H8
L-S3	As-welded	400 [58]	510 [74]	32	264 [195]	-51 [-60]	F7A6-EH12K-H8
LA-71	As-welded	480 [70]	570 [82]	29	143 [105]	-62 [-80]	F7A8-EM14K-H8
LA-71	Stress-relieved ⁽³⁾	430 [63]	550 [80]	31	164 [121]	-62 [-80]	F7P8-EM14K-H8
LA-75	As-welded	440 [64]	550 [80]	31	167 [123]	-62 [-80]	F7A8-ENiK-Ni1-H8
LA-85	As-welded	520 [76]	610 [88]	24	57 [42]	-51 [-60]	F7A6-ENi5-Ni5-H8
LA-85	Stress-relieved ⁽³⁾	490 [71]	590 [85]	27	145 [107]	-62 [-80]	F7P8-ENi5-Ni5-H8
LA-90	As-welded	580 [84]	680 [99]	26	68 [50]	-51 [-60]	F9A6-EA3K-A3-H8
LA-90	Stress-relieved ⁽³⁾	520 [75]	630 [91]	28	145 [107]	-62 [-80]	F9P8-EA3K-A3-H8
LA-92	Stress-relieved ⁽⁴⁾	460 [66]	570 [82]	28	178 [131]	-29 [-20]	F7P2-EB2R-B2-H8
LA-93	Stress-relieved ⁽⁴⁾	510 [74]	610 [88]	26	214 [158]	-18 [0]	F7P0-EB3R-B3-H8
LA-100	As-welded	680 [98]	730 [106]	25	129 [95]	-51 [-60]	F9A6-EM2-M2-H8
LAC-B2	Stress-relieved ⁽⁴⁾	500 [72]	600 [87]	25	144 [106]	-29 [-20]	F8P2-ECB2-B2-H8
LAC-Ni2	As-welded	510 [73]	600 [87]	22	77 [57]	-73 [-100]	F7A10-ECNi2-Ni2-H8
LAC-Ni2	Stress-relieved ⁽³⁾	480 [69]	570 [83]	28	103 [76]	-73 [-100]	F7P10-ECNi2-Ni2-H8

⁽¹⁾See test results disclaimer ⁽²⁾Measured with 0.2% offset. ⁽³⁾Stress-relieved for 1 hour at 621°C [1150°F]. ⁽⁴⁾Stress-relieved for 1 hour at 691°C [1275°F].

NOTE: For the most up-to-date AWS certificates of conformance please visit www.lincolnelectric.com

LINCOLNWELD® 882™

800 Series Neutral Flux

KEY FEATURES

- Designed for a variety of welding applications and is known for providing consistent mechanical properties
- Recommended for stainless steel welding and can be paired with both mild and low alloy steel electrodes
- Smooth bead appearance
- Actual (Type 3.1) certificates for each lot of flux showing chemical composition, particle size and moisture level are available in the certificate center of lincolnelectric.com

PACKAGING

50 lb [22.7 kg] Bag

ED027859

TYPICAL APPLICATIONS

- Single wire or tandem welding
- Used for welding of stainless, mild and low alloy steel
- Excellent for multiple pass fillet welds

RECOMMENDED WIRES

Mild Steel

Lincolnweld® L-50®, L-56®, L-60, L-61®, LA-71, L-S3

Low Alloy Steel

Lincolnweld® L-70, LA-75, LA-85, LA-92, LA-93, LAC-Ni2

PRODUCT INFORMATION

Basicity Index: 1.6

Density: 1.2 g/cm³

FLUX COMPOSITION⁽¹⁾

	%SiO ₂	%MnO	%MgO	%CaF ₂	%Na ₂ O	%Al ₂ O ₃	%CaO	%ZrO ₂	% Metal Alloys
Lincolnweld® 882™	16	1	22	24	2	24	1	7	3 max

AWS TEST RESULTS⁽¹⁾

Flux/Wire Combination	Weld Condition	Yield Strength ⁽²⁾ MPa (ksi)	Tensile Strength MPa (ksi)	Elongation [%]	Charpy V-Notch		AWS Classification (A5.17/A5.23)
					J (ft-lbf)	@ °C (°F)	
L-50®	As-welded	420 (61)	520 (76)	29	130 (96)	-51 [-60]	F7A6-EM13K-H8
L-56®	As-welded	500 (73)	600 (87)	28	92 (68)	-40 [-40]	F7A4-EH11K-H8
L-56®	Stress-relieved ⁽³⁾	420 (61)	560 (81)	30	47 (35)	-46 [-50]	F7P5-EH11K-H8
L-60	As-welded	370 (54)	460 (67)	32	207 (153)	-51 [-60]	F6A6-EL12-H8
L-61®	As-welded	400 (58)	500 (72)	31	190 (140)	-51 [-60]	F7A6-EM12K-H8
L-S3	As-welded	410 (60)	520 (76)	28	130 (96)	-51 [-60]	F7A6-EH12K-H8
LA-71	As-welded	480 (69)	570 (82)	31	61 (45)	-51 [-60]	F7A6-EM14K-H8
LA-71	Stress-relieved ⁽³⁾	430 (62)	550 (80)	32	70 (52)	-51 [-60]	F7P6-EM14K-H8
L-70	Stress-relieved ⁽³⁾	450 (65)	550 (80)	30	76 (56)	-40 [-40]	F7P4-EA1-A2-H8
LA-75	As-welded	430 (62)	540 (79)	32	133 (98)	-40 [-40]	F7A4-ENiK-Ni1-H8
LA-85	As-welded	510 (74)	610 (88)	25	88 (65)	-40 [-40]	F7A4-ENi5-Ni5-H8
LA-85	Stress-relieved ⁽³⁾	500 (73)	590 (86)	26	102 (75)	-40 [-40]	F7P4-ENi5-Ni5-H8
LA-92	Stress-relieved ⁽⁴⁾	520 (75)	610 (89)	27	83 (61)	-29 [-20]	F7P2-EB2R-B2-H8
LA-93	Stress-relieved ⁽⁴⁾	610 (88)	700 (101)	23	214 (158)	-18 (0)	F9P0-EB3R-B3-H8
LAC-Ni2	As-welded	570 (83)	660 (95)	20	72 (53)	-40 [-40]	F8A4-ECNi2-Ni2-H8
LAC-Ni2	Stress-relieved ⁽³⁾	500 (73)	600 (87)	25	100 (74)	-40 [-40]	F7P4-ECNi2-Ni2-H8

⁽¹⁾See test results disclaimer ⁽²⁾Measured with 0.2% offset. ⁽³⁾Stress-relieved for 1 hour at 621°C (1150°F). ⁽⁴⁾Stress-relieved for 1 hour at 691°C (1275°F).

NOTE: For the most up-to-date AWS certificates of conformance please visit www.lincolnelectric.com

LINCOLNWELD® 888™

800 Series Neutral Flux · EN ISO 14174 – S A FB 1

KEY FEATURES

- Designed for deep groove slag removal in critical applications
- Low H4 diffusible hydrogen levels
- Charpy V-Notch and CTOD test results available for most alloy systems
- Actual (Type 3.1) certificates for each lot of flux showing chemical composition, particle size and moisture level are available in the certificate center of lincolnelectric.com

PACKAGING

50 lb (22.7 kg) Plastic Bag ED031596
2600 lb (1179 kg) Foil Lined Bulk Bag ED033490

RECOMMENDED WIRES

Mild Steel
Lincolnweld® L-50°, L-56°, L-53, L-61°, LA-71
Low Alloy Steel
Lincolnweld® L-70, LA-75, LA-84, LA-85, LA-90, LA-100,
LAC-Ni2, LAC-B2, LAC-690

PRODUCT INFORMATION

Basicity Index: 2.2
Density: 1.3 g/cm³

TYPICAL APPLICATIONS

- Excellent operation with multiple arcs
- Offshore
- Structural fabrication
- Shipbuilding

FLUX COMPOSITION⁽¹⁾

	%SiO ₂	%MnO	%MgO	%CaF ₂	%Na ₂ O	%Al ₂ O ₃	%CaO	%FeO	%K ₂ O	% Metal Alloys
Lincolnweld® 888™	18	1	27	25	2	19	5	1	2	3 max

AWS TEST RESULTS⁽¹⁾

Flux/Wire Combination	Weld Condition	Yield Strength ⁽²⁾ MPa (ksi)	Tensile Strength MPa (ksi)	Elongation (%)	Charpy V-Notch		AWS Classification (A5.17/A5.23)
					J [ft-lbf]	@ °C (°F)	
L-50°	As-welded	430 (62)	540 (78)	31	122 (90)	-62 (-80)	F7A8-EM13K-H4
L-50°	Stress-relieved ⁽³⁾	370 (53)	510 (74)	32	187 (138)	-62 (-80)	F6P8-EM13K-H4
L-56°	As-welded	510 (74)	610 (88)	29	71 (52)	-51 (-60)	F8A6-EH11K-H4
L-56°	Stress-relieved ⁽³⁾	410 (59)	540 (79)	32	118 (87)	-62 (-80)	F7P8-EH11K-H4
L-61°	As-welded	420 (61)	520 (75)	31	121 (89)	-51 (-60)	F7A6-EM12K-H4
L-53	As-welded	480 (70)	570 (83)	33	70 (52)	-62 (-80)	F7A8-EH12K-H4
L-53	Stress-relieved ⁽³⁾	370 (54)	510 (74)	33	165 (122)	-62 (-80)	F6P8-EH12K-H4
LA-71	As-welded	520 (75)	610 (89)	28	68 (50)	-51 (-60)	F7A6-EM14K-H4
LA-71	Stress-relieved ⁽³⁾	410 (60)	540 (78)	32	134 (99)	-62 (-80)	F7P8-EM14K-H4
L-70	As-welded	510 (74)	600 (87)	29	60 (45)	-40 (-40)	F7A4-EA1-A2-H4
L-70	Stress-relieved ⁽³⁾	470 (69)	570 (83)	31	126 (93)	-40 (-40)	F7P4-EA1-A2-H4
LA-75	As-welded	470 (68)	580 (84)	31	122 (90)	-62 (-80)	F7A8-ENi1K-Ni1-H4
LA-84	As-welded	630 (92)	720 (105)	23	77 (57)	-62 (-80)	F9A8-EF3-F3-H4
LA-84	Stress-relieved ⁽³⁾	580 (84)	670 (98)	26	34 (25)	-51 (-60)	F8P6-EF3-F3-H4
LA-85	As-welded	540 (78)	640 (92)	26	79 (58)	-51 (-60)	F8A6-ENi5-Ni5-H4
LA-85	Stress-relieved ⁽³⁾	500 (72)	590 (86)	27	76 (56)	-51 (-60)	F7P6-ENi5-Ni5-H4
LA-90	As-welded	610 (89)	700 (102)	26	56 (41)	-51 (-60)	F9A6-EA3K-A3-H4
LA-100	As-welded	690 (100)	760 (111)	25	61 (45)	-40 (-40)	F10A4-EM2-M2-H4
LAC-Ni2	As-welded	540 (78)	630 (92)	20	56 (42)	-62 (-80)	F8A8-ECNi2-Ni2-H8
LAC-Ni2	Stress-relieved ⁽³⁾	480 (70)	580 (84)	27	64 (47)	-73 (-100)	F7P10-ECNi2-Ni2-H8
LAC-690	As-welded	800 (116)	860 (124)	22	91 (67)	-73 (-100)	F11A10-ECG-G-H4
LAC-690	Stress-relieved ⁽³⁾	707 (103)	776 (113)	21	51 (37)	-51 (-60)	F11P6-ECG-G-H4

⁽¹⁾See test results disclaimer ⁽²⁾Measured with 0.2% offset. ⁽³⁾Stress-relieved for 1 hour at 621°C (1150°F). ⁽⁴⁾Stress-relieved for 1 hour at 691°C (1275°F).

NOTE: For the most up-to-date AWS certificates of conformance please visit www.lincolnelectric.com

LINCOLNWELD® 8500™

800 Series Neutral Flux · EN ISO 14174 – S A FB 1

KEY FEATURES

- Capable of providing impact properties necessary for thick weld joints from root to cap pass
- Operates well on AC and multiple arcs with good resistance to nitrogen porosity
- Capable of producing weld deposits with impact properties exceeding 27 J (20 ft-lbf) at -62°C (-80°F)
- CTOD data available for this flux with many alloy systems
- Actual (Type 3.1) certificates for each lot of flux showing chemical composition, particle size and moisture level are available in the certificate center of lincolnelectric.com

PACKAGING

50 lb (22.7 kg) Plastic Bag

ED031854

TYPICAL APPLICATIONS

- Fabrication of offshore drilling platforms
- Multiple pass welding
- Single and multiple arc welding

RECOMMENDED WIRES

Mild Steel

Lincolnweld® L-50°, L-56°, L-61°, L-S3, LA-71

Low Alloy Steel

Lincolnweld® LA-85, LA-90, LA-92

PRODUCT INFORMATION

Basicity Index: 2.9

Density: 1.3 g/cm³

FLUX COMPOSITION⁽¹⁾

	%SiO ₂	%MnO	%MgO	%CaF ₂	%Na ₂ O	%Al ₂ O ₃	%CaO	%K ₂ O	%TiO ₂	% Metal Alloys
Lincolnweld® 8500™	13	1	30	24	2	19	8	1	1	1 max

AWS TEST RESULTS⁽¹⁾

Flux/Wire Combination	Weld Condition	Yield Strength ⁽²⁾ MPa (ksi)	Tensile Strength MPa (ksi)	Elongation (%)	Charpy V-Notch		AWS Classification (A5.17/A5.23)
					J (ft-lbf)	@ °C (°F)	
L-50°	As-welded	430 (63)	520 (76)	32	129 (95)	-62 (-80)	F7A8-EM13K-H8
L-56°	As-welded	470 (68)	570 (82)	31	132 (97)	-62 (-80)	F7A8-EH11K
L-56°	Stress-relieved ⁽³⁾	430 (62)	540 (79)	33	151 (111)	-62 (-80)	F7P8-EH11K
L-61°	As-welded	400 (58)	480 (70)	31	168 (124)	-51 (-60)	F7A6-EM12K-H8
L-S3	As-welded	460 (67)	570 (82)	29	91 (67)	-62 (-80)	F7A8-EH12K-H8
L-70	As-welded	450 (65)	520 (75)	29	211 (156)	-40 (-40)	F7A4-EA1-G-H8
LA-71	As-welded	450 (66)	550 (80)	30	155 (115)	-62 (-80)	F7A8-EM14K-H8
LA-71	Stress-relieved ⁽³⁾	420 (61)	520 (75)	32	220 (162)	-62 (-80)	F7P8-EM14K-H8
LA-85	As-welded	510 (74)	590 (86)	29	155 (114)	-62 (-80)	F8A8-ENI5-NI5-H8
LA-85	Stress-relieved ⁽³⁾	500 (72)	590 (85)	28	134 (99)	-51 (-60)	F7P6-ENI5-NI5-H8
LA-90	As-welded	670 (97)	590 (85)	24	84 (62)	-29 (-20)	F9A2-EA3K-A3-H8
LA-92	Stress-relieved ⁽⁴⁾	550 (80)	640 (93)	26	209 (154)	-18 (0)	F8P0-EB2-B2-H8

⁽¹⁾See test results disclaimer ⁽²⁾Measured with 0.2% offset. ⁽³⁾Stress-relieved for 1 hour at 621°C (1150°F). ⁽⁴⁾Stress-relieved for 1 hour at 691°C (1275°F).

NOTE 1: For the most up-to-date AWS certificates of conformance please visit www.lincolnelectric.com NOTE 2: This product contains micro-alloying elements. Additional information available upon request.

LINCOLNWELD® MIL800-H™

800 Series Neutral Flux · EN ISO 14174 – S A FB 1

KEY FEATURES

- Capable of providing industry leading H₂ diffusible hydrogen levels
- Designed for low temperature applications
- Recommended for both single and multiple arc welding of both butt and fillet welds
- Actual (Type 3.1) certificates for each lot of flux showing chemical composition, particle size and moisture level are available in the certificate center of lincolnelectric.com

PACKAGING

50 lb (22.7 kg)

Hermetically Sealed Foil Bag

ED035892

TYPICAL APPLICATIONS

- HY-80 and HSLA-80 steels with Lincolnweld® LA-100 wire
- Horizontal and flat fillet welds
- Single and multiple arc welding
- High strength or highly restrained weldments where delayed cracking is a concern

RECOMMENDED WIRES

Mild Steel

Lincolnweld® L-53, LA-71

Low Alloy Steel

Lincolnweld® LA-75, LA-85, LA-90, LA-93, LA-100

PRODUCT INFORMATION

Basicity Index: 3.2

Density: 1.3 g/cm³

FLUX COMPOSITION⁽¹⁾

	%SiO ₂	%MnO	%MgO	%CaF ₂	%Na ₂ O	%Al ₂ O ₃	%CaO	%K ₂ O	% Metal Alloys
Lincolnweld® MIL800-H™	13	1	34	23	1	16	8	1	1 max

AWS TEST RESULTS⁽¹⁾

Flux/Wire Combination	Weld Condition	Yield Strength ⁽²⁾ MPa (ksi)	Tensile Strength MPa (ksi)	Elongation [%]	Charpy V-Notch		AWS Classification [A5.17/A5.23]
					J (ft-lbf)	@ °C [°F]	
L-53	As-welded	500 [73]	610 [88]	27	76 [56]	-62 [-80]	F7A8-EH12K-H2
L-53	Stress-relieved ⁽³⁾	440 [64]	570 [82]	30	118 [87]	-62 [-80]	F7P8-EH12K-H2
LA-71	As-welded	470 [68]	570 [82]	30	163 [120]	-51 [-60]	F7A6-EM14K-H2
LA-71	Stress-relieved ⁽³⁾	420 [61]	540 [79]	32	193 [140]	-51 [-60]	F7P6-EM14K-H2
LA-75	As-welded	460 [67]	560 [82]	30	156 [115]	-62 [-80]	F7A8-ENi1K-Ni1-H2
LA-85	As-welded	570 [82]	660 [95]	25	108 [80]	-62 [-80]	F8A8-ENi5-Ni5-H2
LA-85	Stress-relieved ⁽³⁾	540 [78]	630 [92]	26	83 [61]	-62 [-80]	F8P8-ENi5-Ni5-H2
LA-90	As-welded	620 [90]	710 [103]	26	77 [57]	-51 [-60]	F9A6-EA3K-A3-H2
LA-90	Stress-relieved ⁽³⁾	590 [86]	690 [100]	26	84 [62]	-51 [-60]	F9P6-EA3K-A3-H2
LA-93	Stress-relieved ⁽⁴⁾	580 [84]	690 [99]	23	34 [25]	-29 [-20]	F9P2-EB3R-B3R-H2
LA-100	As-welded	670 [97]	780 [112]	25	107 [79]	-51 [-60]	F10A6-EM2-M2-H2
LAC-690	As-welded	750 [109]	830 [120]	21	121 [90]	-51 [-60]	F11A6-ECG-G-H4

⁽¹⁾See test results disclaimer ⁽²⁾Measured with 0.2% offset. ⁽³⁾Stress-relieved for 1 hour at 621°C (1150°F). ⁽⁴⁾Stress-relieved for 1 hour at 691°C (1275°F).

NOTE: For the most up-to-date AWS certificates of conformance please visit www.lincolnelectric.com

LINCOLNWELD® 812-SRC™

800 Series Neutral Flux · EN ISO 14174 – S A FB 1

KEY FEATURES

- Carbon-neutral flux designed to provide excellent mechanical properties after extended stress-relief
- Smooth bead appearance and excellent slag release
- Excellent resistance to moisture pick up
- Actual (Type 3.1) certificates for each lot of flux showing chemical composition, particle size and moisture level are available in the certificate center of lincolnelectric.com

PACKAGING

50 lb [22.7 kg] Plastic Bag ED034171

TYPICAL APPLICATIONS

- Offshore applications with extended post-weld heat treatment (PWHT)
- Quench and tempered steels such as AISI 4130, 8620, and similar chemistries

RECOMMENDED WIRES

Low Alloy Electrodes
Lincolnweld® LA-84

PRODUCT INFORMATION

Basicity Index: 2.2
Density: 1.3 g/cm³

FLUX COMPOSITION⁽¹⁾

	%SiO ₂	%MnO	%MgO	%CaF ₂
Lincolnweld® 812-SRC™	16	3	30	19
	%Na ₂ O	%Al ₂ O ₃	%CaO	% Metal Alloys
Lincolnweld® 812-SRC™	2	22	4	3 max

AWS TEST RESULTS⁽¹⁾

Flux/Wire Combination	Weld Condition	Yield Strength ⁽²⁾ MPa (ksi)	Tensile Strength MPa (ksi)	Elongation [%]	Charpy V-Notch		AWS Classification (A5.17/A5.23)
					J (ft-lbf)	@ °C (°F)	
LA-84	As-welded	680(98)	810(117)	21	81(60)	-51° [-60°]	F10A6-EF3-F3-H4
LA-84	As-welded	680(98)	810(117)	21	81(60)	-51° [-60°]	F10A6-EG-F3-H4
LA-84	Stress-relieved	650(94)	740(107)	25	73(54)	-51° [-60°]	F10P6-EF3-F3-H4
LA-84	Stress-relieved	650(94)	740(107)	25	73(54)	-51° [-60°]	F9P6-EF3-F3-H4
AK-10	Stress-relieved	660 (95)	750 (108)	25	55 (41)	-40° [-40°]	F10P4-EG-G-H4

⁽¹⁾See test results disclaimer ⁽²⁾Measured with 0.2% offset. NOTE 1: For the most up-to-date AWS certificates of conformance please visit www.lincolnelectric.com

LINCOLNWELD® 960®

900 Series Neutral Flux · EN ISO 14174 – S A AB 1

KEY FEATURES

- Low cost, general purpose flux designed to weld butt joints and both single and multiple pass fillets
- A versatile, cost-effective flux that can be used with many alloy systems
- Can be used on weathering steels when combined with Lincolnweld® LA-75
- Actual (Type 3.1) certificates for each lot of flux showing chemical composition, particle size and moisture level are available in the certificate center of lincolnelectric.com

PACKAGING

50 lb (22.7 kg) Bag

ED022412, ED030841*

*Tested Material

TYPICAL APPLICATIONS

- Single and multiple pass welding
- Fillet and butt welds with unlimited plate thickness
- Can weld steel with heavy scale or rust when used with Lincolnweld® L-50® wire

RECOMMENDED WIRES

Mild Steel

Lincolnweld® L-50®, L-61®, LA-71

Low Alloy Steel

Lincolnweld® LA-75, LA-85, LA-93, LA-100

PRODUCT INFORMATION

Basicity Index: 1.1

Density: 1.4 g/cm³

AWS D1.8 AND FEMA 353

Approved when paired with the following wires:

- 3/32-5/32 in (2.4-4.0 mm) Lincolnweld® L-56®
- 3/32-5/32 in (2.4-4.0 mm) Lincolnweld® LA-85

FLUX COMPOSITION⁽¹⁾

	%SiO ₂	%MnO	%MgO	%CaF ₂	%Na ₂ O	%Al ₂ O ₃	%CaO	%TiO ₂	% Metal Alloys
Lincolnweld® 960®	21	10	21	10	2	31	1	1	3 max

AWS TEST RESULTS⁽¹⁾

Flux/Wire Combination	Weld Condition	Yield Strength ⁽²⁾ MPa (ksi)	Tensile Strength MPa (ksi)	Elongation (%)	Charpy V-Notch		AWS Classification (A5.17/A5.23)
					J (ft-lbf)	@ °C (°F)	
L-50®	As-welded	460 (66)	570 (83)	27	58 (43)	-29 (-20)	F7A2-EM13K-H4
L-56	As-welded	460 (67)	590 (86)	29	65 (48)	-29 (-20)	F7A2-EH11K-H4
LA-71	As-welded	460 (66)	570 (82)	29	44 (32)	-29 (-20)	F7A2-EM14K-H4
LA-71	Stress-relieved ⁽³⁾	420 (61)	540 (79)	31	89 (66)	-29 (-20)	F7P2-EM14K-H4
LA-75	As-welded	480 (69)	600 (87)	30	76 (56)	-29 (-20)	F7P6-ENi1K-Ni-H4
LA-75	Stress-relieved ⁽³⁾	420 (61)	550 (80)	29	53 (39)	-51 (-60)	F8A2-ENi1K-Ni-H4
LA-85	As-welded	520 (76)	640 (93)	24	57 (42)	-29 (-20)	F7P5-ENi5-G-H4
LA-85	Stress-relieved ⁽³⁾	500 (73)	610 (88)	25	39 (29)	-46 (-50)	F8A2-ENi5-G-H4
LA-100	As-welded	680 (99)	740 (108)	25	33 (24)	-40 (-40)	F10A4-EM2-G-H4

⁽¹⁾See test results disclaimer ⁽²⁾Measured with 0.2% offset. ⁽³⁾Stress-relieved for 1 hour at 621°C (1150°F). ⁽⁴⁾Stress-relieved for 1 hour at 691°C (1275°F).

NOTE: For the most up-to-date AWS certificates of conformance please visit www.lincolnelectric.com

LINCOLNWELD® 980™

900 Series Neutral Flux · EN ISO 14174 – S A AB 1; EN ISO 14174 – S A AR 1

KEY FEATURES

- Combines many of the features of the 700 and 800 series fluxes
- Exceptional resistance to flash-through and porosity caused by arc blow in a variety of applications
- Especially high productivity when used with Lincolnweld® LC-72 wire
- Actual (Type 3.1) certificates for each lot of flux showing chemical composition, particle size and moisture level are available in the certificate center of lincolnelectric.com

PACKAGING

50 lb (22.7 kg) Bag

ED027861

TYPICAL APPLICATIONS

- Single and multiple pass submerged arc welding
- General purpose fabrication
- Fillet welds

RECOMMENDED WIRES

Mild Steel
 Lincolnweld® L-50®, L-61®, LC-72
 Low Alloy Steel
 Lincolnweld® LA-75, LAC-Ni2

PRODUCT INFORMATION

Basicity Index: 0.6
 Density: 1.4 g/cm³

FLUX COMPOSITION⁽¹⁾

	%SiO ₂	%MnO	%MgO	%CaF ₂	%Na ₂ O	%Al ₂ O ₃	%TiO ₂	% Metal Alloys
Lincolnweld® 980™	11	14	2	12	2	47	7	4 max

AWS TEST RESULTS⁽¹⁾

Flux/Wire Combination	Weld Condition	Yield Strength ⁽²⁾ MPa (ksi)	Tensile Strength MPa (ksi)	Elongation (%)	Charpy V-Notch		AWS Classification (A5.17/A5.23)
					J (ft-lbf)	@ °C [°F]	
L-50®	As-welded	430 (63)	540 (78)	31	43 (32)	-29 [-20]	F7A2-EM13K-H8
L-61®	As-welded	430 (63)	530 (77)	31	37 (27)	-29 [-20]	F7A2-EM12K-H8
LC-72	As-welded	450 (65)	540 (78)	28	43 (32)	-29 [-20]	F7A2-EC1-H8
LA-75	As-welded	510 (74)	600 (87)	28	61 (45)	-29 [-20]	F7A2-ENi1K-Ni1-H8
LAC-Ni2	As-welded	540 (79)	630 (91)	25	110 (81)	-29 [-20]	F8A2-ECNi2-Ni2-H8

⁽¹⁾See test results disclaimer ⁽²⁾Measured with 0.2% offset. NOTE: For the most up-to-date AWS certificates of conformance please visit www.lincolnelectric.com

LINCOLNWELD® WTX™

Neutral Flux · EN ISO 14174 – S A AB 1

KEY FEATURES

- Neutral submerged arc welding flux designed to meet the specific requirements of wind tower welding applications
- Recommended for use with Lincolnweld® L-61® electrode on both longitudinal and circumferential seam welds
- Capable of producing weld deposits with impact properties exceeding 27 J (20 ft-lbf) at -62°C (-80°F)
- Smooth bead profile to achieve excellent toe angles, tie-in, and bead appearance on interior and exterior applications
- Actual (Type 3.1) certificates for each lot of flux showing chemical composition, particle size and moisture level are available in the certificate center of lincolnelectric.com

PACKAGING

50 lb (22.7 kg) Plastic Bag

ED032990

TYPICAL APPLICATIONS

- Wind tower base
- Wind tower door frame

RECOMMENDED WIRES

Mild Steel
Lincolnweld® L-61®
Low Alloy Steel
Lincolnweld® L-70

PRODUCT INFORMATION

Basicity Index: 1.4
Density: 1.2 g/cm³

FLUX COMPOSITION⁽¹⁾

	%SiO ₂	%Mn ₂ O ₃	%MgO	%CaF ₂	%NaO	%Al ₂ O ₃	%CaO	%ZrO ₂	%FeO	%K ₂ O	%TiO ₂
Lincolnweld® WTX™	21	9	23	13	2	25	5	1	2	1	1

AWS TEST RESULTS⁽¹⁾

Flux/Wire Combination	Weld Condition	Yield Strength ⁽²⁾ MPa (ksi)	Tensile Strength MPa (ksi)	Elongation (%)	Charpy V-Notch		AWS Classification [A5.17/A5.23]
					J (ft-lbf)	@ °C (°F)	
L-61	As-welded	430 (63)	540 (78)	31	84 (62)	-62 (-80)	F7A8-EM12K-H8
LA-71	As-welded	560 (82)	630 (92)	28	56 (41)	-51 (-60)	F7A6-EM14K-H8
LA-81	As-welded	600 (87)	700 (102)	27	88 (65)	-51 (-60)	F9TA6-EG-H8
L-70	As-welded	510 (74)	600 (87)	26	29 (22)	-40 (-40)	F8A4-EA1-A3-H8
LA-75	As-welded	560 (82)	650 (94)	27	131 (97)	-40 (-40)	F7A4-ENi1K-G-H8

⁽¹⁾See test results disclaimer ⁽²⁾Measured with 0.2% offset. NOTE: For the most up-to-date AWS certificates of conformance please visit www.lincolnelectric.com

LINCOLNWELD® WTX™ -TR

Neutral Flux • EN ISO 14174 – S A AB 1

KEY FEATURES

- Neutral submerged arc welding flux designed to meet the specific requirements of two-run welding technique for wind tower welding applications
- Recommended for use with non-specific electrode on both longitudinal and circumferential seam welds
- Capable of producing weld deposits with impact properties exceeding 27 J (20 ft-lbf) at -40°C (-40°F) in two run applications
- Smooth bead profile to achieve excellent toe angles, tie-in, and bead appearance on interior and exterior applications
- Actual (Type 3.1) certificates for each lot of flux showing chemical composition, particle size and moisture level are available in the certificate center of lincolnelectric.com

RECOMMENDED WIRES

Mild Steel
Lincolnweld® L-61®, L-54®

TYPICAL APPLICATIONS

- Wind tower base
- Wind tower door frame

PRODUCT INFORMATION

Basicity Index: 1.5
Density: 1.2 g/cm³

PACKAGING

50 lb (22.7 kg) Plastic Bag

ED035463

FLUX COMPOSITION⁽¹⁾

	%SiO ₂	%Mn _x O _y	%MgO	%CaF ₂	%NaO	%Al ₂ O ₃	%CaO	%ZrO ₂	%FeO	%K ₂ O	%TiO ₂	% Metal Alloys
Lincolnweld® WTX™-TR	17	18	22	13	2	25	4	2	3	1	3	<5

AWS TEST RESULTS⁽¹⁾

Flux/Wire Combination	Weld Condition	Yield Strength ⁽²⁾ MPa (ksi)	Tensile Strength MPa (ksi)	Elongation (%)	Charpy V-Notch		AWS Classification (A5.23)
					J (ft-lbf)	@ °C (°F)	
L-61®	As-welded	560 (81)	640 (92)	23	160 (118)	-40 (-40)	F7TA4-EM12K-H8
L-61®	As-welded	500 (81)	640 (85)	28	172 (127)	-40 (-40)	F7TA4-EM12K-H8
L-70	As-welded	540 (78)	630 (91)	29	73 (54)	-40 (-40)	F8TA4-EA1-H8
L-61®	As-welded	510 (74)	580 (85)	28	81 (60)	-51 (-60)	F7A6-EM12K-H8
L-54®	As-welded	560 (82)	670 (97)	26	85 (63)	-40 (-40)	F8A4-EM11K-G-H8

⁽¹⁾See test results disclaimer ⁽²⁾Measured with 0.2% offset. NOTE: For the most up-to-date AWS certificates of conformance please visit www.lincolnelectric.com

LINCOLNWELD® 761-PIPE™

Flux for Seam Welding of Pipe · EN ISO 14174 – S A MS 1; EN ISO 14174 – S A CS 1; EN ISO 14174 – S A GS 1

KEY FEATURES

- Features the chemical composition of 761 with a particle size optimized for seam welding
- Low-melting slag system produces wide flat welds with superior resistance to cracks and pockmarking
- Can handle up to 5 arcs or 5,000 amps
- Actual (Type 3.1) certificates for each lot of flux showing chemical composition, particle size and moisture level are available in the certificate center of lincolnelectric.com

PACKAGING

50 lb (22.7 kg) Plastic Bag
2600 lb (1179 kg) Foil Lined Bulk Bag

ED032797
ED032768

TYPICAL APPLICATIONS

- Single and multiple arc welding
- Longitudinal seam welding of API grade pipe
- Spiral seam welding of API grade or water pipe

RECOMMENDED WIRES

Mild Steel
Lincolnweld® L50, L-60, L-61®

PRODUCT INFORMATION

Basicity Index: 0.8
Density: 1.2 g/cm³

FLUX COMPOSITION⁽¹⁾

	%SiO ₂	%Mn _x O _y	%MgO	%CaF ₂	%NaO	%Al ₂ O ₃	%TiO ₂	%FeO	% Metal Alloys
Lincolnweld® 761-Pipe™	45	19	22	5	2	2	2	1	6 max

AWS TEST RESULTS⁽¹⁾

Flux/Wire Combination	Weld Condition	Yield Strength ⁽²⁾ MPa (ksi)	Tensile Strength MPa (ksi)	Elongation (%)	Charpy V-Notch		AWS Classification [A5.17/A5.23]
					J [ft-lbf]	@ °C (°F)	
L-61®	As-welded	490 (70)	580 (85)	28	54 (40)	-29 (-20)	F7A2-EM12K-H4
L-50	As-welded	420 (62)	550 (80)	31	86 (63)	-29 (-20)	F7A2-EM13K-H4
L-60	As-welded	430 (63)	540 (78)	30	86 (63)	-29 (-20)	F7A2-EL12-H4

⁽¹⁾See test results disclaimer ⁽²⁾Measured with 0.2% offset. NOTE: For the most up-to-date AWS certificates of conformance please visit www.lincolnelectric.com

LINCOLNWELD® P223™

Flux for Seam Welding of Pipe · EN ISO 14174 – S A AB 1

KEY FEATURES

- Industry standard for pipe welding on up to X80 grade pipe
- Fast freezing and easily removable slag for excellent bead profile
- Can be used for welding with up to three arcs
- Actual (Type 3.1) certificates for each lot of flux showing chemical composition, particle size and moisture level are available in the certificate center of lincolnelectric.com

PACKAGING

50 lb (22.7 kg) Plastic Bag
2600 lb (1179 kg) Foil Lined Bulk Bag

ED032764 ED032767

TYPICAL APPLICATIONS

- Pipe welding up to X80 grade pipe
- Two run welding applications for pipe fabrication
- Multiple pass welding for general construction

RECOMMENDED WIRES

Mild Steel
Lincolnweld® L-56®, L-61®, LA-71, L-S3
Low Alloy Steel
Lincolnweld® L-70, LA-90

PRODUCT INFORMATION

Basicity Index: 1.5
Density: 1.2 g/cm³

FLUX COMPOSITION⁽¹⁾

	%SiO ₂	%MnO	%MgO	%CaF ₂	%NaO	%Al ₂ O ₃	%CaO	%TiO ₂	%K ₂ O	%FeO	% Metal Alloys
Lincolnweld® P223™	23	4	21	21	2	20	4	2	1	1	3 max

AWS TEST RESULTS⁽¹⁾

Flux/Wire Combination	Weld Condition	Yield Strength ⁽²⁾ MPa (ksi)	Tensile Strength MPa (ksi)	Elongation (%)	Charpy V-Notch		AWS Classification (A5.17/A5.23)
					J (ft-lbf)	@ °C (°F)	
L-56°	As-welded	500 (73)	620 (90)	30	68 (50)	-51 (-60)	F7A6-EH11K-H8
L-56°	Stress-relieved ⁽³⁾	540 (65)	580 (84)	30	66 (49)	-51 (-60)	F7P6-EH11K-H8
L-61°	As-welded	430 (63)	530 (77)	31	126 (93)	-40 (-40)	F7A4-EM12K
LA-71	As-welded	480 (69)	570 (83)	29	94 (69)	-40 (-40)	F7A4-EM14K-H8
LA-71	Stress-relieved ⁽³⁾	410 (60)	540 (78)	32	76 (56)	-51 (-60)	F7P6-EM14K-H8
L-S3	As-welded	460 (67)	570 (82)	30	88 (65)	-62 (-80)	F7A8-EH12K-H8
L-70	As-welded	550 (80)	650 (94)	25	53 (39)	-29 (-20)	F8A2-EA1-A2
LA-90	As-welded	630 (91)	720 (105)	25	60 (44)	-18 (0)	F9A0-EA3K-G

⁽¹⁾See test results disclaimer ⁽²⁾Measured with 0.2% offset. ⁽³⁾Stress-relieved for 1 hour at 621°C (1150°F).
NOTE: For the most up-to-date AWS certificates of conformance please visit www.lincolnelectric.com

LINCOLNWELD® LPX80N™

Flux for Seam Welding of Pipe · EN ISO 14174 - S A AB 1

KEY FEATURES

- A nitrogen limiting flux designed for seam welding of pipe
- Recommended for longitudinal seam welding on a range of pipe steels
- Less than 5mL/100g of diffusible hydrogen in the weld deposit with both copper coated and non-copper coated (Emergence) welding wire
- Actual (Type 3.1) certificates for each lot of flux showing chemical composition, particle size and moisture level are available in the certificate center of lincolnelectric.com

PACKAGING

50 lb (22.7 kg) Plastic Bag
2600 lb (1179 kg) Foil Lined Bulk Bag

ED036786ED036839

TYPICAL APPLICATIONS

- Single or multiple arc welding
- Longitudinal welding of pipe

RECOMMENDED WIRES

Mild Steel

Lincolnweld® L-61®, Lincolnweld® Emergence™ 61

Low Alloy Steel

Lincolnweld® L-70, LA-81, Lincolnweld® Emergence™ 70, 81

PRODUCT INFORMATION

Basicity Index: 1.2

Density: 1.1 g/cm³

FLUX COMPOSITION⁽¹⁾

	%SiO ₂	%MnO	%MgO	%CaF ₂	%NaO	%Al ₂ O ₃	%CaO	%ZrO ₂	%FeO	%Fe ₂ O ₃	%TiO ₂
Lincolnweld® LPX80N™	23	12	17	12	4	24	5	2	2	3	1

AWS TEST RESULTS⁽¹⁾

Flux/Wire Combination	Weld Condition	Yield Strength ⁽²⁾ MPa [ksi]	Tensile Strength MPa [ksi]	Elongation [%]	Charpy V-Notch		AWS Classification
					J [ft-lbf]	@ °C [°F]	
L-61®	As-welded	540 [78]	630 [92]	28	35 [26]	-29 [-20]	F6TA2-EM12K-H8
L-70	As-welded	510 [74]	620 [90]	26	61 [45]	-29 [-20]	F8TA2-EA1-H8
LA-81	As-welded	560 [82]	650 [94]	25	50 [37]	-51 [-60]	F8TA6-EA2TiB-H8

⁽¹⁾See test results disclaimer ⁽²⁾Measured with 0.2% offset.

NOTE: For the most up-to-date AWS certificates of conformance please visit www.lincolnelectric.com

LINCOLNWELD® SPX80™

Flux for Seam Welding of Pipe · EN ISO 14174 - S A AB 1

KEY FEATURES

- Designed to meet the specific requirements of spiral pipe seam welding of up to API X80 grade pipe
- High speed welding capability for increased productivity
- Capable of producing weld deposits with impact properties exceeding 27 J (20 ft-lbf) at -51°C (-60°F) with Lincolnweld® LA-81
- Smooth bead profile achieves optimal appearance on both inner and outer diameter welds
- Self-peeling slag allows for clean and easy slag removal for reliable non-destructive testing results
- Actual (Type 3.1) certificates for each lot of flux showing chemical composition, particle size and moisture level are available in the certificate center of lincolnelectric.com

TYPICAL APPLICATIONS

- Spiral pipe mills
- Two run welding applications
- Weld up to API X80 pipe

RECOMMENDED WIRES

Mild Steel
Lincolnweld® L-61®

Low Alloy Steel
Lincolnweld® L-70, LA-81, LA-90

PACKAGING

50 lb (22.7 kg) Plastic Bag ED032960
2600 lb (1179 kg) Foil Lined Bulk Bag ED033319

PRODUCT INFORMATION

Basicity Index: 1.2
Density: 1.2 g/cm³

FLUX COMPOSITION⁽¹⁾

	%SiO ₂	%MnO	%MgO	%CaF ₂	%NaO	%Al ₂ O ₃	%CaO	%ZrO ₂	%FeO	%TiO ₂
Lincolnweld® SPX80™	21	9	21	14	1	28	3	2	1	1

AWS TEST RESULTS⁽¹⁾ - TWO RUN

Flux/Wire Combination	Steel Type	Weld Condition	Yield Strength ⁽²⁾ MPa (ksi)	Tensile Strength MPa (ksi)	Elongation [%]	Charpy V-Notch		AWS Classification (A5.17/A5.23)
						J (ft-lbf)	@ °C (°F)	
L-61®	A131	As-welded	400 (67)	600 (86)	30	45 (33)	-18 (0)	F7TA0-EM12K-H8
L-70	X65	As-welded	560 (82)	650 (94)	26	88 (65)	-40 (-40)	F8TA4G-EA1-H8
LA-90	X80	As-welded	570 (83)	690 (100)	27	72 (53)	-40 (-40)	F9TA4G-EA3K-H8
LA-75	A131	As-welded	470 (68)	640 (93)	27	52 (38)	-18 (0)	F7TA0-ENi1K
LA-81	X80	As-welded	550 (80)	640 (93)	28	40 (29)	-40 (-40)	F9TA6G-EA2TiB

⁽¹⁾See test results disclaimer ⁽²⁾Measured with 0.2% offset. NOTE: For the most up-to-date AWS certificates of conformance please visit www.lincolnelectric.com

LINCOLNWELD® SPX80N™

Flux for Seam Welding of Pipe

KEY FEATURES

- A nitrogen limiting flux designed for spiral pipe welding
- Designed to meet the specific requirements of spiral pipe seam welding of up to API X80 grade pipe.
- High speed welding capability for increased productivity
- Smooth bead profile achieves optimal appearance on both inner and outer diameter welds
- Self-peeling slag allows for clean and easy slag removal for reliable non-destructive testing results
- Actual (Type 3.1) certificates for each lot of flux showing chemical composition, particle size and moisture level are available in the certificate center of lincolnelectric.com

TYPICAL APPLICATIONS

- Spiral Pipe Manufacturing
- Weld up to X80 pipe

RECOMMENDED WIRES

Mild Steel
Lincolnweld® L-61®

Low Alloy Steel
Lincolnweld® L-70, LA-81, LA-90

PACKAGING

50 lb (22.7 kg) Plastic Bag ED032960
2600 lb (1179 kg) Foil Lined Bulk Bag ED033319

PRODUCT INFORMATION

Basicity Index: 1.2
Density: 1.2 g/cm³

FLUX COMPOSITION⁽¹⁾

	%SiO ₂	%MnO	%MgO	%CaF ₂	%NaO	%Al ₂ O ₃	%CaO	%ZrO ₂	%FeO	%TiO ₂
Lincolnweld® SPX80N™	19	8	19	8	2	30	7	2	3	1

AWS TEST RESULTS⁽¹⁾ - TWO RUN

Flux/Wire Combination	Steel Type	Weld Condition	Yield Strength ⁽²⁾ MPa (ksi)	Tensile Strength MPa (ksi)	Elongation [%]	Charpy V-Notch		AWS Classification (A5.17/A5.23)
						J (ft-lbf)	@ °C (°F)	
L-61®	X70	As-welded	510 (74)	620 (90)	30	57 (42)	-18 (0)	F8TA0G-EM12K
L-70	X70	As-welded	570 (83)	660 (95)	26	76 (56)	-40 (-40)	F9TA4G-EA1
LA-90	X70	As-welded	600 (87)	710 (103)	26	99 (73)	-51 (-60)	F9TA6G-EA3K
LA-81	X70	As-welded	600 (87)	680 (98)	27	148 (109)	-51 (-60)	F9TA6G-EA2TiB

⁽¹⁾See test results disclaimer ⁽²⁾Measured with 0.2% offset. NOTE: For the most up-to-date AWS certificates of conformance please visit www.lincolnelectric.com

LINCOLNWELD® 995N™

Flux for Seam Welding of Pipe · EN ISO 14174 – S A AB 1

KEY FEATURES

- A nitrogen limiting flux designed for seam welding of pipe
- Recommended for automatic single pass welding with up to five arcs
- Produces welds with minimal buildup and good penetration
- Capable of producing Charpy V-Notch test results required for arctic grade service
- Actual (Type 3.1) certificates for each lot of flux showing chemical composition, particle size and moisture level are available in the certificate center of lincolnelectric.com

PACKAGING

50 lb (22.7 kg) Plastic Bag

ED032831

TYPICAL APPLICATIONS

- Single or multiple arc welding
- High speed longitudinal seam welding on a range of pipe steels
- One side welding requiring impact properties

RECOMMENDED WIRES

Mild Steel
Lincolnweld® L-61®

Low Alloy Steel
Lincolnweld® L-70, LA-81, LA-90

PRODUCT INFORMATION

Basicity Index: 1.3
Density: 1.0 g/cm³

FLUX COMPOSITION⁽¹⁾

	%SiO ₂	%MnO	%MgO	%CaF ₂	%Na ₂ O	%Al ₂ O ₃	%CaO	%ZrO ₂	%FeO	%TiO ₂	% Metal Alloys
Lincolnweld® 995N™	19	11	16	14	3	27	5	2	1	1	3 max

AWS TEST RESULTS⁽¹⁾

Flux/Wire Combination	Weld Condition	Yield Strength ⁽²⁾ MPa (ksi)	Tensile Strength MPa (ksi)	Elongation (%)	Charpy V-Notch		AWS Classification (A5.17/A5.23)
					J (ft·lbf)	@ °C (°F)	
L-70	As-welded	510 [74]	610 [88]	24	73 [54]	-29 [-20]	F8A2-EA1-A4
LA-81	As-welded	590 [96]	660 [96]	26	58 [43]	-29 [-20]	F9A2-EG-G-H4
LA-90	As-welded	600 [87]	700 [102]	25	54 [40]	-29 [-20]	F9A2-EA3K-G-H8

⁽¹⁾See test results disclaimer ⁽²⁾Measured with 0.2% offset. NOTE: For the most up-to-date AWS certificates of conformance please visit www.lincolnelectric.com

LINCOLNWELD® A-XXX10™

High Performance / Alloy Flux · EN ISO 14174 – S A Z 1

KEY FEATURES

- An alloy flux designed to produce a nominal 1% nickel-bearing weld deposit
- Recommended for use on ASTM A533 Class 1 and A588 weathering steels when combined with Lincolnweld® L-61®
- Actual (Type 3.1) certificates for each lot of flux showing chemical composition, particle size and moisture level are available in the certificate center of lincolnelectric.com

PACKAGING

50 lb [22.7 kg] Bag

ED027862

TYPICAL APPLICATIONS

- Welding of A588 weathering steels and ASTM A533-Class 1

RECOMMENDED WIRES

For Low Alloy
Lincolnweld® L-61®

PRODUCT INFORMATION

Basicity Index: 1.0

Density: 1.4 g/cm³

NOTES

- Since the alloy level in the weld deposit depends upon the arc voltage, and thus the arc length, always maintain a consistent arc voltage. If more flexibility in procedure is necessary, use 960 flux and LA-75 electrode.

FLUX COMPOSITION⁽¹⁾

	%SiO ₂	%MnO	%MgO	%CaF ₂	%Na ₂ O	%Al ₂ O ₃	%ZrO ₂	%TiO ₂	% Metal Alloys
Lincolnweld® A-XXX10™	18	5	22	11	2	19	22	1	5 max

AWS TEST RESULTS⁽¹⁾

Flux/Wire Combination	Weld Condition	Yield Strength ⁽²⁾ MPa (ksi)	Tensile Strength MPa (ksi)	Elongation (%)	Charpy V-Notch		AWS Classification [A5.17/A5.23]
					J (ft·lbf)	@ °C (°F)	
L-61®	As-welded	460 [67]	570 [83]	30	85 [63]	-40 [-40]	F7A4-EM12K-Ni1-H8

⁽¹⁾See test results disclaimer ⁽²⁾Measured with 0.2% offset. NOTE: For the most up-to-date AWS certificates of conformance please visit www.lincolnelectric.com

LINCOLNWELD® MIL800-HPNi™

High Performance / Alloy Flux · EN ISO 14174 – S A FB 1

KEY FEATURES

- When used with Lincolnweld® LA-85 the nickel content will increase from a nominal 1% to a minimum 1%
- Use on high performance steel applications, including HPS70W or HPS100W
- Capable of producing ultra low H₂ diffusible hydrogen levels on HPS steels
- Actual [Type 3.1] certificates for each lot of flux showing chemical composition, particle size and moisture level are available in the certificate center of lincolnelectric.com

PACKAGING

50 lb [22.7 kg]

Hermetically Sealed Foil Bag

ED035893

TYPICAL APPLICATIONS

- Bridge fabrication with HPS70W steel, when used with LA-85 wire
- Single or multiple wire arc welding
- Butt and fillet welds on low alloy steels

RECOMMENDED WIRES

Low Alloy Steel

Lincolnweld® LA-75, LA-85, LA-100

PRODUCT INFORMATION

Basicity Index: 3.1

Density: 1.3 g/cm³

FLUX COMPOSITION⁽¹⁾

	%SiO ₂	%MgO	%CaF ₂	%Na ₂ O	%Al ₂ O ₃	%CaO	%TiO ₂	%K ₂ O	%FeO	% Metal Alloys
Lincolnweld® MIL800-HPNi™	13	34	22	1	16	8	2	1	1	3 max

AWS TEST RESULTS⁽¹⁾

Flux/Wire Combination	Weld Condition	Yield Strength ⁽²⁾ MPa (ksi)	Tensile Strength MPa (ksi)	Elongation (%)	Charpy V-Notch		AWS Classification (A5.17/A5.23)
					J [ft-lbf]	@ °C [°F]	
LA-75	As-welded	560 (81)	640 (93)	28	145 (107)	-51 (-60)	F8A6-ENi1K-G-H2
LA-85	As-welded	600 (88)	690 (100)	25	143 (105)	-40 (-40)	F9A4-ENi5-G-H2
LA-100	As-welded	800 (116)	850 (123)	23	91 (67)	-40 (-40)	F11A4-EM2-G-H2

⁽¹⁾See test results disclaimer ⁽²⁾Measured with 0.2% offset. NOTE: For the most up-to-date AWS certificates of conformance please visit www.lincolnelectric.com

LINCOLNWELD® L-50®

Mild Steel Solid Electrode · AWS EM13K

KEY FEATURES

- A low carbon, medium manganese, medium silicon wire
- Pair it with Lincolnweld® 980™ flux for the best flux/wire combination when semiautomatic submerged arc welding
- Actual (Type 3.1) certificates for each lot of wire showing chemical composition are available in the certificate center of lincolnelectric.com

CONFORMANCES

AWS A5.17: EM13K

ISO: SU25

RECOMMENDED FLUXES

Lincolnweld® 760®, 761®, 780®, 781®, 860®, 865™, 880M®, 882™, 888™, 8500™, 960®, 980™, P223™

DIAMETERS / PACKAGING

Diameter in (mm)	60 lb (27.2 kg) Coil	600 lb (272 kg) Speed Feed® Drum	1000 lb (453 kg) Speed Feed® Drum	1000 lb (453 kg) Accu-Trak® Drum	2200 lb (998 kg) Speed Feed® Stem
5/64 (2.0)	ED011335		ED011334		
3/32 (2.4)	ED011328		ED011327		
1/8 (3.2)	ED011323		ED011322		ED033481
5/32 (4.0)	ED011332		ED011331		ED032997
3/16 (4.8)	ED015469		ED015352		

WIRE COMPOSITION⁽¹⁾ - As Required per AWS A5.17

	%C	%Mn	%Si	%S	%P	%Cu
Lincolnweld® L-50®	0.06-0.16	0.90-1.40	0.35-0.75	0.030	0.030	0.35

⁽¹⁾Single values are maximums.

LINCOLNWELD® L-56®

Mild Steel Solid Electrode · AWS EH11K

KEY FEATURES

- A low carbon, high manganese, very high silicon wire
- Can be used with Lincolnweld® 800 series fluxes for welds requiring 480 MPa (70 ksi) tensile strength in stress relieved conditions
- Actual (Type 3.1) certificates for each lot of wire showing chemical composition are available in the certificate center of lincolnelectric.com

CONFORMANCES

AWS A5.17: EH11K

ISO: SU31

RECOMMENDED FLUXES

Lincolnweld® 860®, 880M®, 882™, 888™, 8500™, P223™

DIAMETERS / PACKAGING

Diameter in (mm)	60 lb (27.2 kg) Coil	Accu-Trak® Drum		1000 lb (453 kg) Speed Feed® Reel	1000 lb (453 kg) Speed Feed® Drum	2200 lb (998 kg) Speed Feed® Stem
		500 lb (227 kg)	1000 lb (453 kg)			
5/64 (2.0)	ED011678			EDS01631		
3/32 (2.4)	ED011674				ED030425	
1/8 (3.2)	ED011671				ED030426	ED032998
5/32 (4.0)	EDS11677				ED028264	ED032999
3/16 (4.8)	EDS01107					

WIRE COMPOSITION⁽¹⁾ - As Required per AWS A5.17

	%C	%Mn	%Si	%S	%P	%Cu
Lincolnweld® L-56®	0.06-0.15	1.40-1.85	0.80-1.15	0.030	0.030	0.35

⁽¹⁾Single values are maximums.

LINCOLNWELD® L-60

Mild Steel Solid Electrode · AWS EL12

KEY FEATURES

- A low carbon, low manganese, low silicon general purpose electrode
- Provides the lowest hardness and is best suited for use with the Lincolnweld® 700 series of active fluxes
- Actual (Type 3.1) certificates for each lot of wire showing chemical composition are available in the certificate center of lincolnelectric.com

CONFORMANCES

AWS A5.17: EL12
ISO: S1

RECOMMENDED FLUXES

Lincolnweld® 760°, 761°, 780°, 781™, 860°, 882™

DIAMETERS / PACKAGING

Diameter in. (mm)	60 lb (27.2 kg) Coil	600 lb (272 kg) Speed Feed® Drum	1000 lb (453 kg) Speed Feed® Drum
5/64 (2.0)	ED011762	EDS11760	ED011761
3/32 (2.4)	ED011752		ED011751
1/8 (3.2)	ED011743	EDS11741	ED011742
5/32 (4.0)	ED011758		ED011757
3/16 (4.8)	ED011749		ED011748

WIRE COMPOSITION⁽¹⁾ - As Required per AWS A5.17

	%C	%Mn	%Si	%S	%P	%Cu
Lincolnweld® L-60	0.04-0.14	0.25-0.60	0.10	0.030	0.030	0.35

⁽¹⁾Single values are maximums.

LINCOLNWELD® L-61®

Mild Steel Solid Electrode · AWS EM12K



KEY FEATURES

- Industry standard for submerged arc welding applications
- A low carbon, medium manganese, low silicon general purpose submerged arc electrode
- A good choice for a wide range of applications with single or multiple pass subarc welding
- Actual (Type 3.1) certificates for each lot of wire showing chemical composition are available in the certificate center of lincolnelectric.com

CONFORMANCES

AWS A5.17: EM12K

ISO: S2Si

RECOMMENDED FLUXES

Lincolnweld® 760°, 761°, 780°, 781™, 860°, 865™, 882™, 888™, 761-Pipe™, P223™, 960°, 980™, WTX™, AXXX-10™, 995N™, SPX80™

DIAMETERS / PACKAGING

Diameter in. (mm)	60 lb (27.2 kg) Coil	250 lb (113 kg) Speed Feed® SlimReel™	300 lb (136 kg) Speed Feed® Reel	300 lb (136 kg) Speed Feed® Drum
5/64 (2.0)	ED011825, ED030756*			
3/32 (2.4)	ED011815, ED033875*	ED033074		
1/8 (3.2)	ED011807, ED033876*	ED033075		
5/32 (4.0)	ED011821, ED033877*, ED032097**	ED033076	ED030412	ED030628
3/16 (4.8)	ED011812, ED034055*			
Diameter in. (mm)	600 lb (272 kg) Speed Feed® Drum	750 lb (340 kg) Speed Feed® Reel	1000 lb (453 kg) Speed Feed® Drum	2200 lb (998 kg) Speed Feed® Stem
5/64 (2.0)	EDS11823	ED011826	ED011824	
3/32 (2.4)	EDS11813	EDS11817	ED011814, ED034043*	
1/8 (3.2)	EDS11805	EDS11809	ED011806, ED034044*	ED032973
5/32 (4.0)	EDS11819	ED030012	ED011820, ED034045*, ED030703**	ED032972
3/16 (4.8)			ED011811	ED032994

*Buy America Product **Tested Material

WIRE COMPOSITION⁽¹⁾ - As Required per AWS A5.17

	%C	%Mn	%Si	%S	%P	%Cu
Lincolnweld® L-61®	0.05-0.15	0.80-1.25	0.10-0.35	0.030	0.030	0.35

⁽¹⁾Single values are maximums.

LINCOLNWELD® L-S3

Mild Steel Solid Electrode · AWS EH12K

KEY FEATURES

- A low carbon, high manganese, medium silicon electrode designed for use with the Lincolnweld® 800 series of neutral fluxes
- Capable of producing weld deposits with impact properties exceeding 27 J (20 ft-lbf) at -62°C (-80°F) when used with Lincolnweld® 888™, 8500™, and MIL800-H™ neutral fluxes
- Actual (Type 3.1) certificates for each lot of wire showing chemical composition are available in the certificate center of lincolnelectric.com

CONFORMANCES

AWS A5.17: EH12K

ISO: S3Si

RECOMMENDED FLUXES

Lincolnweld® 860®, 880M®, 882™, 888™, 8500™, MIL800-H™, P223™

DIAMETERS / PACKAGING

Diameter in (mm)	60 lb (27.2 kg) Coil
3/32 (2.4)	ED028538
1/8 (3.2)	ED016767
5/32 (4.0)	ED016248

WIRE COMPOSITION⁽¹⁾ - As Required per AWS A5.17

	%C	%Mn	%Si	%S	%P	%Cu
Lincolnweld® L-S3	0.06-0.15	1.50-2.0	0.25-0.65	0.025	0.025	0.35

⁽¹⁾Single values are maximums.

LINCOLNWELD® LA-71

Mild Steel Solid Electrode · AWS EM14K

KEY FEATURES

- A low carbon, medium manganese, medium silicon electrode containing approximately 0.1% titanium
- Small addition of titanium allows deposits to be stress-relieved with little loss of strength, even with extended stress relief times
- Widely used with neutral basic fluxes in both as-welded and post-weld heat treated conditions
- Actual (Type 3.1) certificates for each lot of wire showing chemical composition are available in the certificate center of lincolnelectric.com

CONFORMANCES

AWS A5.17: EM14K

ISO: SU24

RECOMMENDED FLUXES

Lincolnweld® 860®, 865™, 880M®, 882™, 888™, 8500™, MIL800-H™, 960®, P223™

DIAMETERS / PACKAGING

Diameter in (mm)	60 lb (27.2 kg) Coil	1000 lb (453 kg) Speed Feed® Drum
3/32 (2.4)	ED011052	
1/8 (3.2)	ED011051	EDS30781
5/32 (4.0)	ED011053	EDS30782

WIRE COMPOSITION⁽¹⁾ - As Required per AWS A5.17

	%C	%Mn	%Si	%Ti	%S	%P	%Cu
Lincolnweld® LA-71	0.06-0.19	0.90-1.40	0.35-0.75	0.03-0.17	0.025	0.025	0.35

⁽¹⁾Single values are maximums.

LINCOLNWELD® AK-10™

Low Alloy Solid Electrode · AWS EG

KEY FEATURES

- Capable of producing welds with 690 MPa (100 ksi) tensile strength
- Suitable for use where consumables with less than 1% Ni are required
- Actual (Type 3.1) certificates for each lot of wire showing chemical composition are available in the certificate center of lincolnelectric.com
- Batch Managed Inventory

RECOMMENDED FLUXES

Lincolnweld® 812-SRC™

CONFORMANCES

AWS A5.23: EG

TYPICAL APPLICATIONS

- NACE applications
- Oil tools
- Riser systems
- High-strength pipe

DIAMETERS / PACKAGING

Diameters in (mm)	60 lb (27.2kg) Coil
5/64 (2.0)	ED034904
3/32 (2.4)	ED034905
5/32 (4.0)	ED034907

WIRE COMPOSITION - As required per AWS A5.23

	%C	%Mn	%Si	%Ni	%Mo	%Cr	%S	%P	%V	%Al	%Cu
Lincolnweld® AK-10™	0.10	1.55	0.57	0.88	0.48	0.27	< 0.005	0.01	<0.003	0.004	0.09

LINCOLNWELD® L-70

Low Alloy Solid Electrode · AWS EA1

KEY FEATURES

- A low carbon, medium manganese, low silicon, 1/2% molybdenum wire used for single or multiple pass welds
- A standard choice for pipe fabrication and other limited pass applications
- Actual (Type 3.1) certificates for each lot of wire showing chemical composition are available in the certificate center of lincolnelectric.com

CONFORMANCES

AWS A5.23: EA1
ISO: S2Mo

RECOMMENDED FLUXES

Lincolnweld® 761°, 781™, 860°, 882™, 888™, 995N™, 761-Pipe™, P223™, SPX80™

DIAMETERS / PACKAGING

Diameter in (mm)	60 lb (27.2 kg) Coil	1000 lb (453 kg) Speed Feed® Drum	2200 lb (998 kg) Speed Feed® Drum
5/64 [2.0]	ED012054		
1/8 [3.2]	ED012051	ED021192	ED032971
5/32 [4.0]	ED012053	ED021193	ED032970
3/16 [4.8]	ED012052	EDS21194	ED032996

WIRE COMPOSITION⁽¹⁾ - As Required per AWS A5.23

	%C	%Mn	%Si	%Mo	%S	%P	%Cu
Lincolnweld® L-70	0.05-0.15	0.65-1.00	0.20	0.45-0.65	0.025	0.025	0.35

⁽¹⁾Single values are maximums.

LINCOLNWELD® LA-75

Low Alloy Solid Electrode · AWS ENiK



KEY FEATURES

- A low carbon, medium manganese, high silicon, nickel-bearing electrode designed for use with Lincolnweld® neutral fluxes
- Suitable for use in applications requiring less than 1% Ni wire composition
- Actual (Type 3.1) certificates for each lot of wire showing chemical composition are available in the certificate center of lincolnelectric.com

CONFORMANCES

AWS A5.23: ENiK
ISO: SUN21

RECOMMENDED FLUXES

Lincolnweld® 860°, 865™, 880™, 880M®, 882™, 888™, MIL800-H™, MIL800-HPNi™, 960°, 980™

DIAMETERS / PACKAGING

Diameter in (mm)	60 lb (27.2 kg) Coil	1000 lb (453 kg) Speed Feed® Drum
5/64 [2.0]	ED011066, ED034196*	
3/32 [2.4]	ED011064, ED033878*	ED027225, ED034046*
1/8 [3.2]	ED011062, ED033879*	ED033293
5/32 [4.0]	ED011065, ED033880*	ED027224, ED034048*

*Buy America Product

WIRE COMPOSITION⁽¹⁾ - As Required per AWS A5.23

	%C	%Mn	%Si	%Ni	%S	%P	%Cu
Lincolnweld® LA-75	0.12	0.80-1.40	0.40-0.80	0.75-1.25	0.020	0.020	0.35

⁽¹⁾Single values are maximums.

LINCOLNWELD® LA-81

Low Alloy Solid Electrode · AWS EA2TiB

KEY FEATURES

- A low carbon, medium manganese, low silicon, 1/2% molybdenum wire containing small additions of titanium and boron for improved fracture toughness
- Generally used in two run applications for arctic grade line pipe
- It can be used to weld up to API X90 grade pipe
- Actual (Type 3.1) certificates for each lot of wire showing chemical composition are available in the certificate center of lincolnelectric.com

CONFORMANCES

AWS A5.23: EA2TiB

ISO: SZ

RECOMMENDED FLUXES

Lincolnweld® 995N™, SPX80™

DIAMETERS / PACKAGING

Diameter in (mm)	60 lb (27.2 kg) Coil	1000 lb (453 kg) Speed Feed® Drum	2200 lb (998 kg) Speed Feed® Stem
5/32 (4.0)	ED023163	EDS31060	ED032992

WIRE COMPOSITION⁽¹⁾ - As Required per AWS A5.23

	%C	%Mn	%Si	%S	%P	%Mo	Total %Cu	%Ti	%B
Lincolnweld® LA-81 ⁽¹⁾	0.06	1.04	0.31	0.006	0.008	0.53	0.12	0.06	0.011

⁽¹⁾Single values are maximums.

LINCOLNWELD® LA-84

Low Alloy Solid Electrode · AWS EF3

KEY FEATURES

- A nickel-bearing electrode with 1/2% molybdenum
- Can be used for higher strength weldments where impact properties exceeding 27 J (20 ft-lbf) at -62°C (-80°F) are required
- Suitable for use where consumables with less than 1% Ni are required
- Actual (Type 3.1) certificates for each lot of wire showing chemical composition are available in the certificate center of lincolnelectric.com

CONFORMANCES

AWS A5.23: EF3

ISO: S3Ni1Mo

RECOMMENDED FLUXES

Lincolnweld® 860®, 880M®, 882™, 888™, P223™, MIL800-H™, MIL800-HPNi™

DIAMETERS / PACKAGING

Diameter in (mm)	60 lb (27.2 kg) Coil	1000 lb (453 kg) Speed Feed® Drum
5/64 (2.0)	ED034211	
3/32 (2.4)	ED031871	ED031872
1/8 (3.2)	ED033323	
5/32 (4.0)	ED034212	ED033727

WIRE COMPOSITION⁽¹⁾ - As Required per AWS A5.23

	%C	%Mn	%Si	%Ni	%Mo	%S	%P	%Cu
Lincolnweld® LA-84	0.10-0.18	1.75-2.20	0.2	0.80-1.0	0.45-0.60	0.010-0.020	0.010-0.020	0.05-0.15

⁽¹⁾Single values are maximums.

LINCOLNWELD® LA-85

Low Alloy Solid Electrode · AWS ENi5



KEY FEATURES

- A nickel-bearing wire with 0.2% molybdenum designed for use on weathering steels
- Capable of producing weld deposits with 480-550 MPa (70-80 ksi) tensile strength in the as-welded and stress-relieved conditions
- Actual (Type 3.1) certificates for each lot of wire showing chemical composition are available in the certificate center of lincolnelectric.com

CONFORMANCES

AWS A5.23: ENi5

ISO: SZ

RECOMMENDED FLUXES

Lincolnweld® 860®, 880M®, 882™, 888™, 8500™, MIL800-H™, MIL800-HPNi™, 960®

DIAMETERS / PACKAGING

Diameter in (mm)	60 lb (27.2 kg) Coil	1000 lb (453 kg) Speed Feed® Drum
3/32 (2.4)	ED023166, ED034426*	ED029965
1/8 (3.2)	ED023167	
5/32 (4.0)	ED023168, ED034427*	ED033273
3/16 (4.8)	ED023169, ED035579*	

*Buy America Product

WIRE COMPOSITION⁽¹⁾ - As Required per AWS A5.23

	%C	%Mn	%Si	%Ni	%Mo	%S	%P	%Cu
Lincolnweld® LA-85	0.12	1.20 - 1.60	0.05 - 0.30	0.75 - 1.25	0.10 - 0.30	0.025	0.020	0.35

⁽¹⁾Single values are maximums.

LINCOLNWELD® LA-90

Low Alloy Solid Electrode · AWS EA3K

KEY FEATURES

- A low carbon, high manganese, high silicon, 1/2% molybdenum special purpose wire
- Recommended for seam welding of pipe and for the general welding of high strength plate
- Actual (Type 3.1) certificates for each lot of wire showing chemical composition are available in the certificate center of lincolnelectric.com

CONFORMANCES

AWS A5: EA3K

ISO: SZ

RECOMMENDED FLUXES

Lincolnweld® 880™, 880M®, 888™, 8500™, MIL800-H™, 995N™, P223™, SPX80™

DIAMETERS / PACKAGING

Diameter in (mm)	60 lb (27.2 kg) Coil	750 lb (340 kg) Speed Feed® Reel	1000 lb (453 kg) Speed Feed® Drum
1/16 (1.6)	ED013999		
5/64 (2.0)	ED011086		
3/32 (2.4)	ED011084		
1/8 (3.2)	EDS11083		
5/32 (4.0)	EDS11085	EDS01154	EDS01152

WIRE COMPOSITION⁽¹⁾ - As Required per AWS A5.23

	%C	%Mn	%Si	%Mo	%S	%P	%Cu
Lincolnweld® LA-90	0.05-0.15	1.60-2.10	0.50-0.80	0.40-0.60	0.025	0.025	0.35

⁽¹⁾Single values are maximums.

LINCOLNWELD® LA-100

Low Alloy Solid Electrode · AWS EM2 & ER100S-G & ER110S-G

KEY FEATURES

- A low carbon, high manganese wire with nickel and molybdenum designed to weld high strength steels such as HY-80 and HSLA-80
- Delivers yield strength greater than 690 MPa (100 ksi)
- Low H₂ hydrogen levels can be achieved when used with MIL800-H™ flux
- Actual (Type 3.1) certificates for each lot of wire showing chemical composition are available in the certificate center of lincolnelectric.com

CONFORMANCES

AWS A5: EM2

ISO: SZ

RECOMMENDED FLUXES

Lincolnweld® 880™, 880M®, 888™, MIL800-H™, MIL800-HPNi™, 960®

DIAMETERS / PACKAGING

Diameter in (mm)	60 lb (27.2 kg) Coil
1/16 (1.6)	ED010996
5/64 (2.0)	ED011002
3/32 (2.4)	ED010999
1/8 (3.2)	ED010998
5/32 (4.0)	EDS11001

WIRE COMPOSITION⁽¹⁾ - As Required per AWS A5.23

	%C	%Mn	%Si	%Cr	%Ni	%Mo	%Ti
Lincolnweld® LA-100	0.10	1.25-1.80	0.20-0.60	0.30	1.40-2.10	0.25-0.55	0.10
	%Zr	%Al	%V	%S	%P	%Cu	
Lincolnweld® LA-100	0.10	0.10	0.05	0.015	0.010	0.25	

⁽¹⁾Single values are maximums.

LINCOLNWELD® LC-72™

Mild Steel Cored Electrode · AWS EC1

KEY FEATURES

- A cored wire designed to increase deposition rates 10-30% when used with 980 flux
- Designed to provide optimal bead shape, penetration, and slag removal in semiautomatic submerged arc welding

CONFORMANCES

AWS A5.17: EC1

RECOMMENDED FLUXES

Lincolnweld® 980™

DIAMETERS / PACKAGING

Diameter in (mm)	50 lb (23 kg) Coil	300 lb (136 kg) Speed Feed® Reel	600 lb (272 kg) Speed Feed® Reel	600 lb (272 kg) Speed Feed® Drum
5/64 (2.0)	ED011099		EDS27184	
3/32 (2.4)	ED011098	EDS01186		EDS01187

WIRE COMPOSITION⁽¹⁾ - As Required per AWS A5.23

	%C	%Mn	%Si	%S	%P	%Cu
Lincolnweld® LC-72 ⁽¹⁾	0.15	1.8	0.9	0.035	0.035	0.35

⁽¹⁾Single values are maximums.

LINCOLNWELD® LAC-B2

Low Alloy Cored Electrode · AWS ECB2

KEY FEATURES

- Designed to weld with either single or tandem arcs using a neutral flux
- A cost-effective choice when welding 11/4% chromium, 1/2% molybdenum steels where a low Bruscato factor (X-factor) is not required

CONFORMANCES

AWS A5.23: ECB2

RECOMMENDED FLUXES

Lincolnweld® 880™, 880M®

DIAMETERS / PACKAGING

Diameter in (mm)	50 lb (23 kg) Coil	600 lb (272 kg) Speed Feed® Drum
3/32 (2.4)	ED010954	ED019581
5/32 (4.0)	ED010955	ED019582

LINCOLNWELD® LAC-Ni2

Low Alloy Cored Electrode · AWS ECNi2

KEY FEATURES

- A 2% nickel electrode used primarily in weathering steel applications
- When used with 888 flux, it can produce impact properties exceeding 27 J (20 ft·lbf) at -73°C (-100°F)

CONFORMANCES

AWS A5.23: ECNi2

RECOMMENDED FLUXES

Lincolnweld® 880™, 880M®, 882™, 888™, 980™

DIAMETERS / PACKAGING

Diameter in (mm)	50 lb (23 kg) Coil
3/32 (2.4)	ED010986

LINCOLNWELD® LAC-690

Low Alloy Cored Electrode · AWS ECG

KEY FEATURES

- Combine with Lincolnweld® 888™ flux for H4 diffusible hydrogen weld deposits
- Charpy V-notch test results capable of exceeding 27 J (20 ft-lbf) @ -73°C (-100°F) with Lincolnweld® 888™ flux
- Excellent Tandem, AC and DC Operation
- Clean and easy slag removal minimizes risk of inclusions, even in narrow gap applications

CONFORMANCES

AWS A5.23: ECG

RECOMMENDED FLUXES

Lincolnweld® 888™
Lincolnweld® MIL800-H™

DIAMETERS / PACKAGING

Diameter in (mm)	50 lb (23 kg) Coil
3/32 (2.4)	ED032958
1/8 (3.2)	ED032959
5/32 (4.0)	ED033302

WIRE COMPOSITION⁽¹⁾

	%C	%Mn	%Si	%S	%P
Lincolnweld® LAC-690 ⁽²⁾	0.08	1.51	0.36	0.007	0.011
	%Cr	%Ni	%Mo	%Cu	Diffusible Hydrogen (mL/100g weld deposit)
Lincolnweld® LAC-690 ⁽²⁾	0.36	2.59	0.44	0.04	3.6

⁽¹⁾See test results disclaimer ⁽²⁾Limits are for weld metal deposited with a particular flux (Lincolnweld® 888™ flux).

LINCOLNWELD® EMERGENCE® 61

Mild Steel Solid Electrode · AWS EM12K

KEY FEATURES

- Low carbon, medium manganese, low silicon electrode
- Coated with proprietary surface lubricant which is designed to eliminate one source of wire contamination in pipe mill welding applications
- Improved contact tip life when compared to non-copper coated wire alternatives
- Exact wire composition to Lincolnweld® L-61® copper coated wires makes requalification for welding procedures controlled by classification seamless

CONFORMANCES

AWS A5.23: EM12K

RECOMMENDED FLUXES:

995N, 998N, 761, 761-PIPE

DIAMETERS / PACKAGING

Diameter in (mm)	1000 lb (453 kg) Drum Package
1/8 (3.2)	ED035980
5/32 (4.0)	ED035981

WIRE COMPOSITION - As Required per AWS A5.23

	%C	%Mn	%Si	%S	%P	%Cu
Lincolnweld® Emergence® 61	0.05-0.15	0.80-1.25	0.10-0.35	0.03	0.03	0.35

LINCOLNWELD® EMERGENCE® 73

Mild Steel Solid Electrode · AWS EG

KEY FEATURES

- Low carbon, high manganese, medium silicon electrode
- Coated with proprietary surface lubricant which is designed to eliminate one source of wire contamination in pipe mill welding applications
- Improved contact tip life when compared to non-copper coated wire alternatives
- Exact wire composition to Lincolnweld® LS-3 copper coated wires makes requalification for welding procedures controlled by classification seamless

CONFORMANCES

AWS A5.23: EG

RECOMMENDED FLUXES:

995N, 998N, 761, 761-PIPE

DIAMETERS / PACKAGING

Diameter in (mm)	1000 lb (453 kg) Drum Package
1/8 (3.2)	ED036348
5/32 (4.0)	ED036349

WIRE COMPOSITION⁽¹⁾ - As Required per AWS A5.23

	%C	%Mn	%Si	%S	%P	%Cu
Lincolnweld® Emergence® 73	0.15	1.59	0.20	0.006	0.007	0.012

⁽¹⁾ No AWS limits. Values are typical.

LINCOLNWELD® EMERGENCE® 70

Low Alloy Solid Electrode · AWS EA1

KEY FEATURES

- Low carbon, medium manganese, low silicon, 1/2% molybdenum electrode
- Coated with proprietary surface lubricant which is designed to eliminate one source of wire contamination in pipe mill welding applications
- Improved contact tip life when compared to non-copper coated wire alternatives
- Exact wire composition to Lincolnweld® L-70 copper coated wires makes requalification for welding procedures controlled by classification seamless

CONFORMANCES

AWS A5.23: EA1

RECOMMENDED FLUXES:

995N, 998N, 761, 761-PIPE

DIAMETERS / PACKAGING

Diameter in (mm)	1000 lb (453 kg) Drum Package
1/8 (3.2)	ED035982
5/32 (4.0)	ED035983

WIRE COMPOSITION - As Required per AWS A5.23

	%C	%Mn	%Si	%Mo	%S	%P	%Cu
Lincolnweld® Emergence® 70	0.05-0.15	0.65-1.00	0.30	0.45-0.65	0.025	0.025	0.35

LINCOLNWELD® EMERGENCE® 81

Low Alloy Solid Electrode · AWS EA2TiB

KEY FEATURES

- Low carbon, medium manganese, low silicon, 1/2% molybdenum electrode containing small additions of titanium and boron for improved fracture toughness
- Coated with proprietary surface lubricant which is designed to eliminate one source of wire contamination in pipe mill welding applications
- Improved contact tip life when compared to non-copper coated wire alternatives
- Exact wire composition to Lincolnweld LA-81 copper coated wires makes requalification for welding procedures controlled by classification seamless

CONFORMANCES

AWS A5.23: EA2TiB

RECOMMENDED FLUXES:

995N, 998N, 761, 761-PIPE

DIAMETERS / PACKAGING

Diameter in (mm)	1000 lb (453 kg) Drum Package
1/8 (3.2)	ED036506
5/32 (4.0)	ED036507

WIRE COMPOSITION - As Required per AWS A5.23

	%C	%Mn	%Si	%Mo	%S	%P	%Cu	%Ti	%B
Lincolnweld® Emergence® 81	0.05 – 0.17	0.95 – 1.35	0.35 max	0.45 – 0.65	0.025 max	0.025 max	0.35 max	0.05 – 0.30	0.005 – 0.030

LINCOLNWELD® EMERGENCE® 90

Low Alloy Solid Electrode · AWS EA3K

KEY FEATURES

- Low carbon, high manganese, 1/2% molybdenum electrode
- Coated with proprietary surface lubricant which is designed to eliminate one source of wire contamination in pipe mill welding applications
- Improved contact tip life when compared to non-copper coated wire alternatives
- Exact wire composition to Lincolnweld® LA-90 copper coated wires makes requalification for welding procedures controlled by classification seamless

CONFORMANCES

AWS A5.23: EA3K

RECOMMENDED FLUXES:

995N, 998N, 761, 761-PIPE

DIAMETERS / PACKAGING

Diameter in (mm)	1000 lb (453 kg) Drum Package
1/8 (3.2)	ED036374
5/32 (4.0)	ED036375

WIRE COMPOSITION - As Required per AWS A5.23

	%C	%Mn	%Si	%Mo	%S	%P	%Cu
Lincolnweld® Emergence® 90	0.05-0.15	1.60-2.10	0.50-0.80	0.40-0.60	0.025	0.025	0.35

CONSUMABLES

STAINLESS



EXCALIBUR® 308/308L-15

Stainless · AWS E308-15, E308L-15

KEY FEATURES

- Versatile electrode designed to weld several types of austenitic steels
- Designed with low carbon levels to help eliminate carbide precipitation in high temperature service
- Excellent for all welding positions, including vertical down on pipe
- Q2 Lot® - Certificate showing actual deposit composition and ferrite number (FN) by ferrite scope available online

WELDING POSITIONS

All

CONFORMANCES

AWS A5.4:	E308-15, E308L-15
ASME SFA-5.4:	E308-15, E308L-15
ABS:	E308-15, E308L-15

TYPICAL APPLICATIONS

- 304 and 304L stainless steels
- Common austenitic stainless steels referred to as "18-8" steels

DIAMETERS / PACKAGING

Diameter in (mm)	Length in (mm)	8 lb (3.6 kg) Easy Open Can 24 lb (10.9 kg) Master Carton
3/32 (2.4)	12 (300)	ED033087
1/8 (3.2)	12 (300)	ED033088

MECHANICAL PROPERTIES⁽¹⁾ – As Required per AWS A5.4

	Yield Strength ⁽²⁾ MPa (ksi)	Tensile Strength MPa (ksi)	Elongation %	Ferrite Number
Requirements AWS E308-15 AWS E308L-15	Not Specified Not Specified	550 (80) min 520 (75) min	35 min 35 min	Not Specified Not Specified
Typical Results⁽³⁾ - As-Welded	455 (66)	625 (91)	44	8 -10

DEPOSIT COMPOSITION⁽¹⁾ – As Required per AWS A5.4

	%C ⁽⁴⁾	%Cr	%Ni	%Mo	%Mn
Requirements - AWS E308L-15	0.04 max	18.0-21.0	9.0-11.0	0.75 max	0.5-2.5
Typical Results⁽³⁾	≤0.03	≤19.9	9.9-10.2	0.05-0.09	0.7-0.8
	%Si	%P	%S	%Cu	
Requirements - AWS E308L-15	1.00 max	0.04 max	0.03 max	0.75 max	
Typical Results⁽³⁾	0.69-0.73	≤0.02	≤0.01	≤0.08	

TYPICAL OPERATING PROCEDURES

Polarity	Current (Amps)	
	3/32 in (2.4 mm)	1/8 in (3.2 mm)
DC+	60-70	90-100

⁽¹⁾Typical all weld metal. ⁽²⁾Measured with 0.2% offset. ⁽³⁾See test results disclaimer ⁽⁴⁾AWS Requirement for E308-15 is 0.08% max. carbon.

IMPORTANT: SPECIAL VENTILATION AND/OR EXHAUST REQUIRED

Fumes from the normal use of some welding products can contain significant quantities of components - such as chromium and manganese - which can lower the 5.0 mg/m³ maximum exposure guideline for general welding fume. BEFORE USE, READ AND UNDERSTAND THE SAFETY DATA SHEET (SDS) FOR THIS PRODUCT AND SPECIFIC INFORMATION PRINTED ON THE PRODUCT CONTAINER.

EXCALIBUR® 308L-16

Stainless · AWS E308L-16

KEY FEATURES

- Flux coating provides smooth arc transfer in all welding positions, except vertical down
- Versatile electrode designed to weld several types of austenitic stainless steels
- Q2 Lot® - Certificate showing actual deposit composition and ferrite number (FN) by ferrite scope available online

WELDING POSITIONS

All, except vertical down

CONFORMANCES

AWS A5.4:	E308L-16
ASME SFA-5.4:	E308L-16
CWB/CSA:	E308L-16
WBS:	E308L-16

TYPICAL APPLICATIONS

- Type 302, 304 and 304L stainless steels
- A743 and A744 Type CF-8 cast material

DIAMETERS / PACKAGING

Diameter in (mm)	Length in (mm)	8 lb (3.6 kg) Easy Open Can 24 lb (10.9 kg) Master Carton	10 lb (4.5 kg) Easy Open Can 30 lb (13.6 kg) Master Carton
3/32 (2.4)	12 (300)	ED033079	ED033080 ED033081 ED033082
1/8 (3.2)	14 (350)		
5/32 (4.0)	14 (350)		
3/16 (4.8)	14 (350)		

MECHANICAL PROPERTIES⁽¹⁾ – As Required per AWS A5.4

	Yield Strength ⁽²⁾ MPa (ksi)	Tensile Strength MPa (ksi)	Elongation %	Ferrite Number
Requirements - AWS E308L-16	Not Specified	520 (75) min	35 min	Not Specified
Typical Results ⁽³⁾ - As-Welded	370-420 (54-61)	540-595 (78-86)	50-55	8-9

DEPOSIT COMPOSITION⁽¹⁾ – As Required per AWS A5.4

	%C	%Cr	%Ni	%Mo	%Mn
Requirements - AWS E308L-16	0.04 max	18.0-21.0	9.0-11.0	0.75 max.	0.5-2.5
Typical Results ⁽³⁾	0.02-0.03	19.5-19.8	9.7-10.3	0.04-0.13	0.6-0.9
	%Si	%P	%S	%Cu	
Requirements - AWS E308L-16	1.00 max	0.04 max	0.03 max	0.75 max	
Typical Results ⁽³⁾	0.29-0.36	≤0.03	≤0.02	≤0.10	

TYPICAL OPERATING PROCEDURES

Polarity ⁽⁴⁾	Current (Amps)			
	3/32 in (2.4 mm)	1/8 in (3.2 mm)	5/32 in (4.0 mm)	3/16 in (4.8 mm)
DC+	40-70	60-100	90-140	120-185
AC	40-70	60-100	90-140	120-185

⁽¹⁾Typical all weld metal. ⁽²⁾Measured with 0.2% offset. ⁽³⁾See test results disclaimer ⁽⁴⁾Preferred polarity is listed first.

IMPORTANT: SPECIAL VENTILATION AND/OR EXHAUST REQUIRED

Fumes from the normal use of some welding products can contain significant quantities of components - such as chromium and manganese - which can lower the 5.0 mg/m³ maximum exposure guideline for general welding fume. BEFORE USE, READ AND UNDERSTAND THE SAFETY DATA SHEET (SDS) FOR THIS PRODUCT AND SPECIFIC INFORMATION PRINTED ON THE PRODUCT CONTAINER.

EXCALIBUR® 308/308H-16

Stainless · AWS E308-16, E308H-16

KEY FEATURES

- Flux coating provides smooth transfer for all position except vertical down
- Higher carbon content improves strength in higher temperature applications
- Q2 Lot® - Certificate showing actual deposit composition and ferrite number (FN) by ferrite scope available online

WELDING POSITIONS

All, except vertical down

CONFORMANCES

AWS A5.4:	E308-16, E308H-16
ASME SFA-5.4:	E308-16, E308H-16
CWB/CSA:	E308-16, E308H-16

TYPICAL APPLICATIONS

- 304 and 304H stainless steels
- ASTM A743 or A744 Types CF-8 and CF-10
- Common austenitic stainless steels referred to as "18-8" steels

DIAMETERS / PACKAGING

Diameter in (mm)	Length in (mm)	8 lb (3.6 kg) Easy Open Can 24 lb (10.9 kg) Master Carton	10 lb (4.5 kg) Easy Open Can 30 lb (13.6 kg) Master Carton
3/32 (2.4)	12 (300)	ED033083	ED033084 ED033085 ED033086
1/8 (3.2)	14 (350)		
5/32 (4.0)	14 (350)		
3/16 (4.8)	14 (350)		

MECHANICAL PROPERTIES⁽¹⁾ – As Required per AWS A5.4

	Yield Strength ⁽²⁾ MPa (ksi)	Tensile Strength MPa (ksi)	Elongation %	Ferrite Number
Requirements AWS E308-16 AWS E308H-16	Not Specified Not Specified	550 (80) min 550 (80) min	35 min 35 min	Not Specified Not Specified
Typical Results⁽³⁾ - As-Welded	435-545 (63-79)	595-640 (86-93)	41-48	4-6

DEPOSIT COMPOSITION⁽¹⁾ – As Required per AWS A5.4

	%C ⁽⁴⁾	%Cr	%Ni	%Mo	%Mn
Requirements - AWS E308H-16	0.04 - 0.08 ⁽⁴⁾	18.0 - 21.0	9.0 - 11.0	0.75 max.	0.5 - 2.5
Typical Results⁽³⁾	0.05 - 0.06	19.7 - 20.3	9.9 - 10.1	0.03 - 0.07	0.7 - 0.8
	%Si	%P	%S	%Cu	
Requirements - AWS E308H-16	1.00 max	0.04 max	0.03 max	0.75 max	
Typical Results⁽³⁾	0.30 - 0.40	≤0.03	≤0.02	≤0.17	

TYPICAL OPERATING PROCEDURES

Polarity ⁽⁵⁾	Current (Amps)			
	3/32 in (2.4 mm)	1/8 in (3.2 mm)	5/32 in (4.0 mm)	3/16 in (4.8 mm)
DC+	40 - 70	60 - 100	90 - 140	120 - 185
AC	40 - 70	60 - 100	90 - 140	120 - 185

⁽¹⁾Typical all weld metal. ⁽²⁾Measured with 0.2% offset. ⁽³⁾See test results disclaimer ⁽⁴⁾AWS Requirement for E308-16 is 0.08% max carbon. ⁽⁵⁾Preferred polarity is listed first.

IMPORTANT: SPECIAL VENTILATION AND/OR EXHAUST REQUIRED

Fumes from the normal use of some welding products can contain significant quantities of components - such as chromium and manganese - which can lower the 5.0 mg/m³ maximum exposure guideline for general welding fume. BEFORE USE, READ AND UNDERSTAND THE SAFETY DATA SHEET (SDS) FOR THIS PRODUCT AND SPECIFIC INFORMATION PRINTED ON THE PRODUCT CONTAINER.

EXCALIBUR® 308/308L-17

Stainless · AWS E308-17, E308L-17

KEY FEATURES

- Flux coating provides smooth arc transfer in all positions except vertical down on sizes 5/32" and smaller
- Versatile electrode designed to weld several types of austenitic stainless steels
- Designed with low carbon levels to help eliminate carbide precipitation in high temperature service
- Q2 Lot[®] - Certificate showing actual deposit composition and ferrite number (FN) by ferrite scope available online

WELDING POSITIONS

- 3/16 in (4.8 mm) diameter Flat and Horizontal only
- Diameters up to and including 5/32 in (4.0mm) are designed for all position welding except vertical down

CONFORMANCES

AWS A5.4:	E308-17, E308L-17
ASME SFA-5.4:	E308-17, E308L-17
CWB/CSA:	E308-17, E308L-17
ABS:	E308-17, E308L-17

TYPICAL APPLICATIONS

- 304 and 304L stainless steels
- Common austenitic stainless steels referred to as "18-8" steels
- ASTM A743 or A744 Types CF-8 and CF-6

DIAMETERS/PACKAGING

Diameter in (mm)	Length in (mm)	1 lb (0.5 kg) Plastic Tube 6 lb (2.7 kg) Master Carton	8 lb (3.6 kg) Easy Open Can 24 lb (10.9 kg) Master Carton	10 lb (4.5 kg) Easy Open Can 30 lb (13.6 kg) Master Carton
3/32 (2.4)	12 (300)	ED033093	ED033089	ED033090 ED033091 ED033092
1/8 (3.2)	14 (350)			
5/32 (4.0)	14 (350)			
3/16 (4.8)	14 (350)			

MECHANICAL PROPERTIES⁽¹⁾ – As Required per AWS A5.4

	Yield Strength ⁽²⁾ MPa (ksi)	Tensile Strength MPa (ksi)	Elongation %	Ferrite Number
Requirements AWS E308-17 AWS E308L-17	Not Specified Not Specified	550 (80) min 520 (75) min	35 min 35 min	Not Specified Not Specified
Typical Results⁽³⁾ - As-Welded	425 - 470 (62 - 68)	585 - 635 (85 - 92)	42 - 50	6 - 11

DEPOSIT COMPOSITION⁽¹⁾ – As Required per AWS A5.4

	%C ⁽⁴⁾	%Cr	%Ni	%Mo	%Mn
Requirements - AWS E308L-17	0.04 max	18.0 - 21.0	9.0 - 11.0	0.75 max.	0.5 - 2.5
Typical Results⁽³⁾	≤0.03	20.0 - 20.5	9.7 - 9.9	≤0.20	0.6 - 0.7
	%Si	%P	%S	%Cu	
Requirements - AWS E308L-17	1.00 max	0.04 max	0.03 max	0.75 max	
Typical Results⁽³⁾	0.56 - 0.77	≤0.03	≤0.02	≤0.22	

TYPICAL OPERATING PROCEDURES

Polarity ⁽⁵⁾	Current (Amps)			
	3/32 in (2.4 mm)	1/8 in (3.2 mm)	5/32 in (4.0 mm)	3/16 in (4.8 mm)
DC+	40 - 80	75 - 110	95 - 150	130 - 200
AC	40 - 80	75 - 110	95 - 150	130 - 200

⁽¹⁾Typical all weld metal. ⁽²⁾Measured with 0.2% offset. ⁽³⁾See test results disclaimer ⁽⁴⁾AWS Requirement for E308-17 is 0.08% max. carbon. ⁽⁵⁾Preferred polarity is listed first.

IMPORTANT: SPECIAL VENTILATION AND/OR EXHAUST REQUIRED

Fumes from the normal use of some welding products can contain significant quantities of components - such as chromium and manganese - which can lower the 5.0 mg/m³ maximum exposure guideline for general welding fume. BEFORE USE, READ AND UNDERSTAND THE SAFETY DATA SHEET (SDS) FOR THIS PRODUCT AND SPECIFIC INFORMATION PRINTED ON THE PRODUCT CONTAINER.

EXCALIBUR® 309/309L-15

Stainless · AWS E309-15, E309L-15

KEY FEATURES

- Fast freezing coating is great for vertical down welding
- Designed with low carbon levels to help eliminate carbide precipitation
- Q2 Lot® - Certificate showing actual deposit composition and ferrite number (FN) by ferrite scope available online

WELDING POSITIONS

All

CONFORMANCES

AWS A5.4: E309-15, E309L-15

ASME SFA-5.4 ABS: E309-15, E309L-15

ABS: E309-15, E309L-15

TYPICAL APPLICATIONS

- Dissimilar joints between stainless steels

DIAMETERS / PACKAGING

Diameter in (mm)	Length in (mm)	8 lb (3.6 kg) Easy Open Can 24 lb (10.9 kg) Master Carton
3/32 (2.4)	12 (300)	ED033098
1/8 (3.2)	12 (300)	ED033099

MECHANICAL PROPERTIES⁽¹⁾ – As Required per AWS A5.4

	Yield Strength ⁽²⁾ MPa (ksi)	Tensile Strength MPa (ksi)	Elongation %	Ferrite Number
Requirements AWS E309-15 AWS E309L-15	Not Specified Not Specified	550 (80) min 520 (75) min	30 min 30 min	Not Specified Not Specified
Typical Results⁽³⁾ - As-Welded	490 (71)	640 (93)	38	6-8

DEPOSIT COMPOSITION⁽¹⁾ - As Required per AWS A5.4

	%C ⁽⁴⁾	%Cr	%Ni	%Mo	%Mn
Requirements - AWS E309L-15	0.04 max	22.0-25.0	12.0-14.0	0.75 max.	0.5-2.5
Typical Results⁽⁵⁾	≤0.03	23.6-23.9	13.6-13.8	0.03-0.05	0.7-1.0
	%Si	%P	%S	%Cu	
Requirements - AWS E309L-15	1.00 max	0.04 max	0.03 max	0.75 max	
Typical Results⁽⁵⁾	0.74-0.82	≤0.02	≤0.01	≤0.06	

TYPICAL OPERATING PROCEDURES

Polarity ⁽⁶⁾	Current (Amps)	
	3/32 in (2.4 mm)	1/8 in (3.2 mm)
DC+	60-70	90-100

⁽¹⁾Typical all weld metal. ⁽²⁾Measured with 0.2% offset. ⁽³⁾See test results disclaimer ⁽⁴⁾AWS Requirement for E309-15 is 0.15% max. carbon. ⁽⁵⁾Preferred polarity is listed first.

IMPORTANT: SPECIAL VENTILATION AND/OR EXHAUST REQUIRED

Fumes from the normal use of some welding products can contain significant quantities of components - such as chromium and manganese - which can lower the 5.0 mg/m³ maximum exposure guideline for general welding fume. BEFORE USE, READ AND UNDERSTAND THE SAFETY DATA SHEET (SDS) FOR THIS PRODUCT AND SPECIFIC INFORMATION PRINTED ON THE PRODUCT CONTAINER.

EXCALIBUR® 309/309L-16

Stainless · AWS E309-16, E309L-16

KEY FEATURES

- Flux coating provides smooth arc transfer in all welding positions, except vertical down
- Q2 Lot® - Certificate showing actual deposit composition and ferrite number (FN) by ferrite scope available online

WELDING POSITIONS

All, except vertical down

CONFORMANCES

AWS A5.5:	E309-16, E309L-16
ASME SFA-5.4:	E309-16, E309L-16
CWB/CSA:	E309-16, E309L-16
ABS:	E309-16, E309L-16

TYPICAL APPLICATIONS

- Designed for joining stainless steel to mild or low alloy steel
- Industrial & General Fabrication

DIAMETERS / PACKAGING

Diameter in (mm)	Length in (mm)	8 lb (3.6 kg) Easy Open Can 24 lb (10.9 kg) Master Carton	10 lb (4.5 kg) Easy Open Can 30 lb (13.6 kg) Master Carton
3/32 (2.4)	12 (300)	ED033097	ED033094 ED033095 ED033096
1/8 (3.2)	14 (350)		
5/32 (4.0)	14 (350)		
3/16 (4.8)	14 (350)		

MECHANICAL PROPERTIES⁽¹⁾ – As Required per AWS A5.4

	Yield Strength ⁽²⁾ MPa (ksi)	Tensile Strength MPa (ksi)	Elongation %	Ferrite Number
Requirements AWS E309-16 AWS E309L-16	Not Specified Not Specified	550 (80) min 520 (75) min	30 min 30 min	Not Specified Not Specified
Typical Results⁽³⁾ - As-Welded	455-470 (66-68)	580-585 (84-85)	38-47	10-18

DEPOSIT COMPOSITION⁽¹⁾ – As Required per AWS A5.4

	%C ⁽⁴⁾	%Cr	%Ni	%Mo	%Mn
Requirements - AWS E309L-16	0.04 max	22.0-25.0	12.0-14.0	0.75 max	0.5-2.5
Typical Results⁽³⁾	0.02-0.04	23.9-24.5	12.6-13.2	0.05-0.09	1.0-1.5
	%Si	%P	%S	%Cu	
Requirements - AWS E309L-16	1.00 max	0.04 max	0.03 max	0.75 max	
Typical Results⁽³⁾	0.33-0.38	≤0.03	≤0.02	≤0.09	

TYPICAL OPERATING PROCEDURES

Polarity ⁽⁵⁾	Current (Amps)			
	3/32 in (2.4 mm)	1/8 in (3.2 mm)	5/32 in (4.0 mm)	3/16 in (4.8 mm)
DC+	40-70	60-100	90-140	120-185
AC	40-70	60-100	90-140	120-185

⁽¹⁾Typical all weld metal. ⁽²⁾Measured with 0.2% offset. ⁽³⁾See test results disclaimer. ⁽⁴⁾AWS Requirement for E309-16 is 0.15% max. carbon. ⁽⁵⁾Preferred polarity is listed first.

IMPORTANT: SPECIAL VENTILATION AND/OR EXHAUST REQUIRED

Fumes from the normal use of some welding products can contain significant quantities of components - such as chromium and manganese - which can lower the 5.0 mg/m³ maximum exposure guideline for general welding fume. BEFORE USE, READ AND UNDERSTAND THE SAFETY DATA SHEET (SDS) FOR THIS PRODUCT AND SPECIFIC INFORMATION PRINTED ON THE PRODUCT CONTAINER.

EXCALIBUR® 309/309L-17

Stainless · AWS E309-17, E309L-17

KEY FEATURES

- Flux coating provides for smooth arc transfer in the flat and horizontal positions
- Designed with low carbon levels to help eliminate carbide precipitation
- Q2 Lot® - Certificate showing actual deposit composition and ferrite number (FN) by ferrite scope available online

WELDING POSITIONS

- 5/32 in (4.0 mm) and smaller diameter all except Vertical Down
- 3/16 in (4.8 mm) diameter Flat and Horizontal only

CONFORMANCES

AWS A5.5:	E309-17 E309L-17
ASME SFA-5.4:	E309-17 E309L-17
CWB/CSA:	E309-17 E309L-17
ABS:	E309-17 E309L-17

TYPICAL APPLICATIONS

- Designed for joining stainless steel to mild or low alloy steel
- Industrial & General Fabrication

DIAMETERS / PACKAGING

Diameter in (mm)	Length in (mm)	8 lb (3.6 kg) Easy Open Can 24 lb (10.9 kg) Master Carton	10 lb (4.5 kg) Easy Open Can 30 lb (13.6 kg) Master Carton
3/32 (2.4)	12 (300)	ED033100	ED033101 ED033102 ED033103
1/8 (3.2)	14 (350)		
5/32 (4.0)	14 (350)		
3/16 (4.8)	14 (350)		

MECHANICAL PROPERTIES⁽¹⁾ – As Required per AWS A5.4

	Yield Strength ⁽²⁾ MPa (ksi)	Tensile Strength MPa (ksi)	Elongation %	Ferrite Number
Requirements AWS E309-17 AWS E309L-17	Not Specified Not Specified	550 (80) min 520 (75) min	30 min 30 min	Not Specified Not Specified
Typical Results⁽³⁾ - As-Welded	455-490 (66-71)	585-620 (85-90)	37-45	7-11

DEPOSIT COMPOSITION⁽¹⁾ – As Required per AWS A5.4

	%C ⁽⁴⁾	%Cr	%Ni	%Mo	%Mn
Requirements - AWS E309L-17	0.04 max	22.0-25.0	12.0-14.0	0.75 max.	0.5-2.5
Typical Results⁽³⁾	0.02-0.04	23.5-24.0	13.0-13.5	0.05-0.09	0.7-0.9
	%Si	%P	%S	%Cu	
Requirements - AWS E309L-17	1.00 max	0.04 max	0.03 max	0.75 max	
Typical Results⁽³⁾	0.72-0.77	≤0.03	≤0.01	≤0.17	

TYPICAL OPERATING PROCEDURES

Polarity ⁽⁵⁾	Current (Amps)			
	3/32 in (2.4 mm)	1/8 in (3.2 mm)	5/32 in (4.0 mm)	3/16 in (4.8 mm)
DC+	40-80	75-110	95-150	130-200
AC	40-80	75-110	95-150	130-200

⁽¹⁾Typical all weld metal. ⁽²⁾Measured with 0.2% offset. ⁽³⁾See test results disclaimer ⁽⁴⁾AWS Requirement for E309-17 is 0.15% max. carbon. ⁽⁵⁾Preferred polarity is listed first.

IMPORTANT: SPECIAL VENTILATION AND/OR EXHAUST REQUIRED

Fumes from the normal use of some welding products can contain significant quantities of components - such as chromium and manganese - which can lower the 5.0 mg/m³ maximum exposure guideline for general welding fume. BEFORE USE, READ AND UNDERSTAND THE SAFETY DATA SHEET (SDS) FOR THIS PRODUCT AND SPECIFIC INFORMATION PRINTED ON THE PRODUCT CONTAINER.

EXCALIBUR® 310-16

Stainless · AWS E310-16

KEY FEATURES

- Used for high operating temperature stainless applications
- Multiple purpose austenitic, heat resistant stainless
- Minimal heat input required during welding

WELDING POSITIONS

All, except vertical down

CONFORMANCES

AWS A5.4:	E310-16
ASME SFA-A5.4:	E310-16

TYPICAL APPLICATIONS

- Heat Shields
- Furnace Parts
- Ducting
- Welding 310/310s materials

DIAMETERS / PACKAGING

Diameter in (mm)	Length in (mm)	8 lb (3.6 kg) Easy Open Can 24 lb (10.9 kg) Master Carton	10 lb (4.5 kg) Easy Open Can 30 lb (13.6 kg) Master Carton
3/32 (2.4)	12 (305)	ED034993	ED034994 ED034995
1/8 (3.2)	14 (355)		
5/32 (4.0)	14 (355)		

DEPOSIT COMPOSITION⁽¹⁾ - As Required per AWS A5.4

	%C ⁽²⁾	%Cr	%Ni	%Mo	%Mn
Requirements AWS E310-16	0.08 - 0.20	25.0 - 28.0	20.0 - 22.5	0.75 max	1.0 - 2.5
Typical Results⁽³⁾	0.11	25.5	21.0	0.1	2.0
	%Si	%P	%S	%Cu	FN
Requirements AWS E310-16	0.75 max	0.03 max	0.03 max	0.75 max	Not Required
Typical Results⁽³⁾	0.58	0.02	0.01	0.02	-

TYPICAL OPERATING PROCEDURES

Polarity ⁽⁴⁾	Current (Amps)			
	3/32 in (2.4 mm)	1/8 in (3.2 mm)	5/32 in (4.0 mm)	3/16 in (4.8 mm)
DC+	40-80	75-110	95-150	130-200
AC	40-80	75-110	95-150	130-200

⁽¹⁾Typical all weld metal. ⁽²⁾See test results disclaimer ⁽³⁾AWS Requirement for E310-16 is 0.20% max carbon. ⁽⁴⁾Preferred polarity is listed first.

IMPORTANT: SPECIAL VENTILATION AND/OR EXHAUST REQUIRED

Fumes from the normal use of some welding products can contain significant quantities of components - such as chromium and manganese - which can lower the 5.0 mg/m³ maximum exposure guideline for general welding fume. BEFORE USE, READ AND UNDERSTAND THE SAFETY DATA SHEET (SDS) FOR THIS PRODUCT AND SPECIFIC INFORMATION PRINTED ON THE PRODUCT CONTAINER.

EXCALIBUR® 312-16

Stainless · AWS E312-16

KEY FEATURES

- Can be used for joining hard to weld materials and dissimilar metals
- Applications should be limited to 800°F (420°C)
- The weld deposits exhibit high tensile strength and offer some resistance to abrasion
- Weld deposits work-hardens and allows for good wear resistance

WELDING POSITIONS

All, except vertical down

CONFORMANCES

AWS A5.4:	E312-16
ASME SFA-A5.4:	E312-16

TYPICAL APPLICATIONS

- Tool Steels
- Hard to Weld Steels
- Cast and Wrought Alloys
- Dissimilar Metals

DIAMETERS / PACKAGING

Diameter in (mm)	Length in (mm)	10 lb (4.5 kg) Easy Open Can 30 lb (13.6 kg) Master Carton
1/8 (3.2)	14 (355)	ED034996
5/32 (4.0)	14 (355)	ED034997
3/16 (4.8)	14 (355)	ED034998

DEPOSIT COMPOSITION⁽¹⁾ - As Required per AWS A5.4

	%C	%Cr	%Ni	%Mo	%Mn
Requirements AWS E312-16	0.15 max	28.0 - 32.0	8.0 - 10.5	0.75 max	0.5 - 2.5
Typical Results⁽²⁾	0.12	29.4	9.4	0.15	1.4
	%Si	%P	%S	%Cu	FN
Requirements AWS E312-16	1.00 max	0.04 max	0.03 max	0.75 max	Not Required
Typical Results⁽²⁾	0.57	0.02	0.01	0.06	30 - 60

TYPICAL OPERATING PROCEDURES

Polarity	Current (Amps)			
	3/32 in (2.4 mm)	1/8 in (3.2 mm)	5/32 in (4.0 mm)	3/16 in (4.8 mm)
DC+	40-80	75-110	95-150	130-200
AC	40-80	75-110	95-150	130-200

⁽¹⁾Typical all weld metal. ⁽²⁾See test results disclaimer

IMPORTANT: SPECIAL VENTILATION AND/OR EXHAUST REQUIRED

Fumes from the normal use of some welding products can contain significant quantities of components - such as chromium and manganese - which can lower the 5.0 mg/m³ maximum exposure guideline for general welding fume. BEFORE USE, READ AND UNDERSTAND THE SAFETY DATA SHEET (SDS) FOR THIS PRODUCT AND SPECIFIC INFORMATION PRINTED ON THE PRODUCT CONTAINER.

EXCALIBUR® 316/316L-15

Stainless · AWS E316-15, E316L-15

KEY FEATURES

- Flux coating is fast freezing for vertical down welding
- Molybdenum grade for increased corrosion resistance
- Designed with low carbon levels to help eliminate carbide precipitation
- Q2 Lot® - Certificate showing actual deposit composition and ferrite number (FN) by ferrite scope available online

WELDING POSITIONS

All

CONFORMANCES

AWS A5.4:	E316-15, E316L-15
ASME SFA-5.4:	E316-15, E316L-15
CWB/CSA:	E316-15, E316L-15
ABS:	E316-15, E316L-15

TYPICAL APPLICATIONS

- Molybdenum bearing austenitic stainless steels
- Welding type 316 and 316L stainless steels
- Vertical and overhead welding applications

DIAMETERS / PACKAGING

Diameter in (mm)	Length in (mm)	8 lb (3.6 kg) Easy Open Can 24 lb (10.9 kg) Master Carton
3/32 (2.4)	12 (300)	ED033108
1/8 (3.2)	12 (300)	ED033109

MECHANICAL PROPERTIES⁽¹⁾ – As Required per AWS A5.4

	Yield Strength ⁽²⁾ MPa (ksi)	Tensile Strength MPa (ksi)	Elongation %	Ferrite Number
Requirements AWS E316-15 AWS E316L-15	Not Specified Not Specified	520 (75) min 490 (70) min	30 min 30 min	Not Specified Not Specified
Typical Results⁽³⁾ - As-Welded	470 (68)	620 (90)	38	4 - 12

DEPOSIT COMPOSITION⁽¹⁾ – As Required per AWS A5.4

	%C ⁽⁴⁾	%Cr	%Ni	%Mo	%Mn
Requirements - AWS E316L-15	0.04 max	17.0-20.0	11.0-14.0	2.0-3.0	0.05-2.5
Typical Results⁽³⁾	≤0.02	18.6-19.3	12.0-12.4	2.2-2.6	≤0.7
	%Si	%P	%S	%Cu	
Requirements - AWS E316L-15	1.00 max	0.04 max	0.03 max	0.75 max	
Typical Results⁽³⁾	0.72-0.74	≤0.02	≤0.01	≤0.24	

TYPICAL OPERATING PROCEDURES

Polarity	Current (Amps)	
	3/32 in (2.4 mm)	1/8 in (3.2 mm)
DC+	60-70	90-100

⁽¹⁾Typical all weld metal. ⁽²⁾Measured with 0.2% offset. ⁽³⁾See test results disclaimer ⁽⁴⁾AWS Requirement for E316-15 is 0.08% max. carbon.

IMPORTANT: SPECIAL VENTILATION AND/OR EXHAUST REQUIRED

Fumes from the normal use of some welding products can contain significant quantities of components - such as chromium and manganese - which can lower the 5.0 mg/m³ maximum exposure guideline for general welding fume. BEFORE USE, READ AND UNDERSTAND THE SAFETY DATA SHEET (SDS) FOR THIS PRODUCT AND SPECIFIC INFORMATION PRINTED ON THE PRODUCT CONTAINER.

EXCALIBUR® 316/316L-16

Stainless · AWS E316-16, E316L-16

KEY FEATURES

- Flux coating provides smooth arc transfer in all welding positions, except vertical down
- Molybdenum grade for increased corrosion resistance
- Designed with low carbon levels to help eliminate carbide precipitation
- Q2 Lot® - Certificate showing actual deposit composition and ferrite number (FN) by ferrite scope available online

WELDING POSITIONS

All, except vertical down

CONFORMANCES

AWS A5.4:	E316-16, E316L-16
CWB/CSA:	E316-16, E316L-16
ABS:	E316-16, E316L-16

TYPICAL APPLICATIONS

- Molybdenum bearing austenitic stainless steels
- Type 316 and 316L stainless steel

DIAMETERS / PACKAGING

Diameter in (mm)	Length in (mm)	8 lb [3.6 kg] Easy Open Can 24 lb [10.9 kg] Master Carton	10 lb [4.5 kg] Easy Open Can 30 lb [13.6 kg] Master Carton
3/32 [2.4]	12 [300]	ED033104	ED033105 ED033106 ED033107
1/8 [3.2]	14 [350]		
5/32 [4.0]	14 [350]		
3/16 [4.8]	14 [350]		

MECHANICAL PROPERTIES⁽¹⁾ – As Required per AWS A5.4

	Yield Strength ⁽²⁾ MPa (ksi)	Tensile Strength MPa (ksi)	Elongation %	Ferrite Number
Requirements				
AWS E316-16	Not Specified	520 (75) min	30 min	Not Specified
AWS E316L-16	Not Specified	490 (70) min	30 min	Not Specified
Typical Results⁽³⁾ - As-Welded	425-450 [62-65]	560-585 [81-85]	40-54	7-14

DEPOSIT COMPOSITION⁽¹⁾ – As Required per AWS A5.4

	%C ⁽⁴⁾	%Cr	%Ni	%Mo	%Mn
Requirements - AWS E316L-16	0.04 max	17.0-20.0	11.0-14.0	2.0-3.0	0.05-2.5
Typical Results⁽³⁾	0.03-0.04	18.7-19.2	11.4-12.1	2.2-2.4	0.7-0.9
	%Si	%P	%S	%Cu	
Requirements - AWS E316L-16	1.00 max	0.04 max	0.03 max	0.75 max	
Typical Results⁽³⁾	0.29-0.39	≤0.02	≤0.02	≤0.26	

TYPICAL OPERATING PROCEDURES

Polarity ⁽⁵⁾	Current (Amps)			
	3/32 in [2.4 mm]	1/8 in [3.2 mm]	5/32 in [4.0 mm]	3/16 in [4.8 mm]
DC+	40-70	60-100	90-140	120-185
AC	40-70	60-100	90-140	120-185

⁽¹⁾Typical all weld metal. ⁽²⁾Measured with 0.2% offset. ⁽³⁾See test results disclaimer ⁽⁴⁾AWS Requirement for E316-16 is 0.08% max. carbon. ⁽⁵⁾Preferred polarity is listed first.

IMPORTANT: SPECIAL VENTILATION AND/OR EXHAUST REQUIRED

Fumes from the normal use of some welding products can contain significant quantities of components - such as chromium and manganese - which can lower the 5.0 mg/m³ maximum exposure guideline for general welding fume. BEFORE USE, READ AND UNDERSTAND THE SAFETY DATA SHEET (SDS) FOR THIS PRODUCT AND SPECIFIC INFORMATION PRINTED ON THE PRODUCT CONTAINER.

EXCALIBUR® 316/316L-17

Stainless · AWS E316-17, E316L-17

KEY FEATURES

- Substantial ferrite content for crack resistance
- Molybdenum grade for increased corrosion resistance
- Designed with low carbon levels to help eliminate carbide
- Q2 Lot® - Certificate showing actual deposit composition and ferrite number (FN) by ferrite scope available online

WELDING POSITIONS

- All, except vertical down 5/32 in and smaller diameter
- 3/16 in diameter on Flat and Horizontal only

CONFORMANCES

AWS A5:	E316-17, E316L-17
CWB/CSA:	E316-17, E316L-17
ABS:	E316-17, E316L-17

TYPICAL APPLICATIONS

- 316 and 316L stainless steel
- ASTM A240 Type 316 and 316L stainless steel
- ASTM A743 or A744 Types CF-8M and CF-3M
- For joining extra low carbon molybdenum bearing austenitic stainless steels

DIAMETERS / PACKAGING

Diameter in (mm)	Length in (mm)	8 lb (3.6 kg) Easy Open Can 24 lb (10.9 kg) Master Carton	10 lb (4.5 kg) Easy Open Can 30 lb (13.6 kg) Master Carton
3/32 [2.4]	12 [300]	ED033110	
1/8 [3.2]	14 [350]		ED033111
5/32 [4.0]	14 [350]		ED033112
3/16 [4.8]	14 [350]		ED033113

MECHANICAL PROPERTIES⁽¹⁾ – As Required per AWS A5.4

	Yield Strength ⁽²⁾ MPa (ksi)	Tensile Strength MPa (ksi)	Elongation %	Ferrite Number
Requirements AWS E316-17 AWS E316L-17	Not Specified Not Specified	520 (75) min. 490 (70) min.	30 min. 30 min.	Not Specified Not Specified
Typical Results⁽³⁾ - As-Welded	469 (68)	590 (85)	45	7-14

DEPOSIT COMPOSITION⁽¹⁾ – As Required per AWS A5.4

	%C ⁽⁴⁾	%Cr	%Ni	%Mo	%Mn
Requirements - AWS E316L-17	0.04 max	17.0-20.0	11.0-14.0	2.0-3.0	0.5-2.5
Typical Results⁽³⁾	≤0.03	19.1-19.7	11.6-12.7	2.1-2.4	0.8-1.0
	%Si	%P	%S	%Cu	
Requirements - AWS E316L-17	1.00 max	0.04 max	0.03 max	0.75 max	
Typical Results⁽³⁾	0.61-0.72	≤0.02	≤0.01	≤0.26	

TYPICAL OPERATING PROCEDURES

Polarity ⁽⁵⁾	Current (Amps)			
	3/32 in (2.4 mm)	1/8 in (3.2 mm)	5/32 in (4.0 mm)	3/16 in (4.8 mm)
DC+	40-80	75-110	95-150	130-200
AC	40-80	75-110	95-150	130-200

⁽¹⁾Typical all weld metal. ⁽²⁾Measured with 0.2% offset. ⁽³⁾See test results disclaimer ⁽⁴⁾AWS Requirement for E316-17 is 0.08% max. carbon. ⁽⁵⁾Preferred polarity is listed first.

IMPORTANT: SPECIAL VENTILATION AND/OR EXHAUST REQUIRED

Fumes from the normal use of some welding products can contain significant quantities of components - such as chromium and manganese - which can lower the 5.0 mg/m³ maximum exposure guideline for general welding fume. BEFORE USE, READ AND UNDERSTAND THE SAFETY DATA SHEET (SDS) FOR THIS PRODUCT AND SPECIFIC INFORMATION PRINTED ON THE PRODUCT CONTAINER.

EXCALIBUR® 317L

Stainless · AWS E317L-16

KEY FEATURES

- Higher molybdenum content than 316L
- Electrodes are used for welding alloys with similar compositions used in highly corrosive environments
- Q2 Lot® - certificates showing actual deposit composition available online

CONFORMANCES

AWS A5.4: E317L/ 317L-16

ASME SFA-A5.4: E317L/ 317L-16

TYPICAL APPLICATIONS

- FGP
- Chemical Processing Plants
- Condensers
- Petrochemical

DIAMETERS / PACKAGING

Diameter in (mm)	Length in (mm)	8 lb (3.6 kg) Tube 24 lb (10.9 kg) Master Carton	10 lb (4.5 kg) Tube 30 lb (13.6 kg) Master Can
3/32 (2.4)	12 (305)	EL317L16093632	EL317L16125634 EL317L16156634
1/8 (3.2)	14 (355)		
5/32 (4.0)	14 (355)		

Deposit COMPOSITION⁽¹⁾ - As Required per AWS A5.11

	%C	%Cr	%Ni	%Mo	%Mn
Requirements AWS E317L-16	0.04 max	18.0 - 21.0	12.0 - 14.0	3.0 - 4.0	0.5 - 2.5
Typical Results⁽²⁾ Tech-Rod® 317L	0.02	19.7	13.1	3.6	1.4
	%Si	%P	%S	%Cu	FN
Requirements AWS E317L-16	1.00 max	0.04 max	0.03 max	0.75 max	Not Required
Typical Results⁽²⁾ Tech-Rod® 317L	0.48	0.02	0.01	0.15	4 - 9

TYPICAL OPERATING PROCEDURES

Diameter in (mm)	Length in (mm)	Amperage	
		Flat	Vertical & Overhead
3/32 (2.4)	12 (305)	70-85	65-75
1/8 (3.2)	14 (355)	85-110	80-90
5/32 (4.0)	14 (355)	110-140	100-120

⁽¹⁾Typical deposit composition. ⁽²⁾See test results disclaimer
Safety Data Sheets (SDS) are available on our website at www.lincolnelectric.com

EXCALIBUR® 320LR-16

Stainless · AWS E320LR-16

KEY FEATURES

- Good corrosion resistance in acidic environments
- Low heat input welding procedures should be used to prevent solidification cracking

WELDING POSITIONS

All, except vertical down

CONFORMANCES

AWS A5.4:	E320LR-16
ASME SFA-A5.4:	E320LR-16

TYPICAL APPLICATIONS

- Process Piping
- Heat Exchangers
- Welding Alloy 20 and similar materials
- Chemical Processing Plants

DIAMETERS / PACKAGING

Diameter in (mm)	Length in (mm)	8 lb (3.6 kg) Easy Open Can 24 lb (10.9 kg) Master Carton	10 lb (4.5 kg) Easy Open Can 30 lb (13.6 kg) Master Carton
3/32 (2.4)	12 (305)	ED034999	ED035000 ED035001 ED035002
1/8 (3.2)	14 (355)		
5/32 (4.0)	14 (355)		
3/16 (4.8)	14 (355)		

DEPOSIT COMPOSITION⁽¹⁾

	%C	%Cr	%Ni	%Mo	%Nb+Ta	%Mn
Requirements AWS E320LR-16	0.03 max	19.0 - 21.0	32.0 - 36.0	2.0 - 3.0	0.4 max	1.50 - 2.50
Typical Results⁽²⁾	0.02	19.9	33.8	2.3	0.1	1.70
	%Si	%P	%S	%Cu	FN	
Requirements AWS E320LR-16	0.30 max	0.020 max	0.015 max	3.0 - 4.0	Not Required	
Typical Results⁽²⁾	0.16	0.016	0.006	3.2	-	

TYPICAL OPERATING PROCEDURES

Polarity ⁽³⁾	Current (Amps)			
	3/32 in (2.4 mm)	1/8 in (3.2 mm)	5/32 in (4.0 mm)	3/16 in (4.8 mm)
DC+	40-80	75-110	95-150	130-200
AC	40-80	75-110	95-150	130-200

⁽¹⁾Typical all weld metal. ⁽²⁾See test results disclaimer ⁽³⁾Preferred polarity is listed first.

IMPORTANT: SPECIAL VENTILATION AND/OR EXHAUST REQUIRED

Fumes from the normal use of some welding products can contain significant quantities of components - such as chromium and manganese - which can lower the 5.0 mg/m³ maximum exposure guideline for general welding fume. BEFORE USE, READ AND UNDERSTAND THE SAFETY DATA SHEET (SDS) FOR THIS PRODUCT AND SPECIFIC INFORMATION PRINTED ON THE PRODUCT CONTAINER.

EXCALIBUR® 330-16

Stainless · AWS E330-16

KEY FEATURES

- Offers good heat and scale resistance to 1800°F (980°C)
- Low heat input welding procedures should be used to prevent solidification cracking
- High sulfur environments adversely affect the high temperature performance

WELDING POSITIONS

All, except vertical down

CONFORMANCES

AWS A5.4:	E330-16
ASME SFA-A5.4:	E330-16

TYPICAL APPLICATIONS

- Heat Treatment
- Furnace Components
- Welding 330 stainless and similar materials
- High Temperature Environments

DIAMETERS / PACKAGING

Diameter in (mm)	Length in (mm)	8 lb (3.6 kg) Easy Open Can 24 lb (10.9 kg) Master Carton	10 lb (4.5 kg) Easy Open Can 30 lb (13.6 kg) Master Carton
3/32 (2.4)	12 (305)	ED035003	ED035004 ED035005
1/8 (3.2)	14 (355)		
5/32 (4.0)	14 (355)		

DEPOSIT COMPOSITION⁽¹⁾

	%C ⁽²⁾	%Cr	%Ni	%Mo	%Mn
Requirements AWS E330-16	0.18 - 0.25	14.0 - 17.0	33.0 - 37.0	0.75 max	1.0 - 2.5
Typical Results⁽³⁾	0.21	15.5	34.3	0.13	1.7
	%Si	%P	%S	%Cu	FN
Requirements AWS E330-16	1.00 max	0.04 max	0.03 max	0.75 max	Not Required
Typical Results⁽⁴⁾	0.49	0.02	0.003	0.06	-

TYPICAL OPERATING PROCEDURES

Polarity ⁽⁴⁾	Current (Amps)			
	3/32 in (2.4 mm)	1/8 in (3.2 mm)	5/32 in (4.0 mm)	3/16 in (4.8 mm)
DC+	40-80	75-110	95-150	130-200
AC	40-80	75-110	95-150	130-200

⁽¹⁾Typical all weld metal. ⁽²⁾See test results disclaimer ⁽³⁾AWS Requirement for E316-17 is 0.08% max. carbon. ⁽⁴⁾Preferred polarity is listed first.

IMPORTANT: SPECIAL VENTILATION AND/OR EXHAUST REQUIRED

Fumes from the normal use of some welding products can contain significant quantities of components - such as chromium and manganese - which can lower the 5.0 mg/m³ maximum exposure guideline for general welding fume. BEFORE USE, READ AND UNDERSTAND THE SAFETY DATA SHEET (SDS) FOR THIS PRODUCT AND SPECIFIC INFORMATION PRINTED ON THE PRODUCT CONTAINER.

EXCALIBUR® 347-16

Stainless · AWS E347-16

KEY FEATURES

- Niobium stabilized stainless steel electrodes
- The addition of niobium reduces intergranular corrosion in severe operating conditions
- High tensile and yield strength results, as well as superior resistance to Sulfide Corrosion Cracking (SCC) and pitting corrosion
- Q2 Lot[®] - Certificate showing actual deposit composition and ferrite number (FN) by ferrite scope available online

WELDING POSITIONS

All, except vertical down

CONFORMANCES

AWS A5.4:	E347-16
ASME SFA-A5.4:	E347-16

TYPICAL APPLICATIONS

- Process Piping
- Power Generation Equipment
- Welding 321 and 347 Stainless Steels
- Powergen
- Refinery Applications

DIAMETERS / PACKAGING

Diameter in (mm)	Length in (mm)	8 lb (3.6 kg) Easy Open Can 24 lb (10.9 kg) Master Carton	10 lb (4.5 kg) Easy Open Can 30 lb (13.6 kg) Master Carton
3/32 [2.4]	12 [305]	ED035006	ED035007 ED035008 ED035009
1/8 [3.2]	14 [355]		
5/32 [4.0]	14 [355]		
3/16 [4.8]	14 [355]		

DEPOSIT COMPOSITION⁽¹⁾

	%C	%Cr	%Ni	%Mo	%Nb+Ta	%Mn
Requirements AWS E347-16	0.08 max	18.0 - 21.0	9.0 - 11.0	0.75 max	8 x C to 1.00 max	0.5 - 2.5
Typical Results⁽²⁾	0.03	19.5	10.1	0.19	0.36	1.5
	%Si	%P	%S	%Cu	FN	
Requirements AWS E347-16	1.00 max	0.04 max	0.03 max	0.75 max	Not Required	
Typical Results⁽²⁾	0.54	0.02	0.01	0.16	2-8	

TYPICAL OPERATING PROCEDURES

Polarity ⁽³⁾	Current (Amps)			
	3/32 in (2.4 mm)	1/8 in (3.2 mm)	5/32 in (4.0 mm)	3/16 in (4.8 mm)
DC+	40-80	75-110	95-150	130-200
AC	40-80	75-110	95-150	130-200

⁽¹⁾Typical all weld metal. ⁽²⁾See test results disclaimer. ⁽³⁾Preferred polarity is listed first.

IMPORTANT: SPECIAL VENTILATION AND/OR EXHAUST REQUIRED

Fumes from the normal use of some welding products can contain significant quantities of components - such as chromium and manganese - which can lower the 5.0 mg/m³ maximum exposure guideline for general welding fume. BEFORE USE, READ AND UNDERSTAND THE SAFETY DATA SHEET (SDS) FOR THIS PRODUCT AND SPECIFIC INFORMATION PRINTED ON THE PRODUCT CONTAINER.

EXCALIBUR® 385-16

Stainless · AWS E385-16

KEY FEATURES

- The weld metal is fully austenitic
- Minimal heat input welding procedures should be used to avoid solidification cracking

WELDING POSITIONS

All, except vertical down

CONFORMANCES

AWS A5.4:	E385-16
ASME SFA A5.4:	E385-16

TYPICAL APPLICATIONS

- Welding 904L Stainless Steels
- Papermill Equipment
- Chemical process equipment
- Used in fabrication of equipment and vessels for handling and storage of sulfuric acid and phosphoric acid

DIAMETERS / PACKAGING

Diameter in (mm)	Length in (mm)	8 lb (3.63kg) Easy Open Can 24 lb (10.89kg) Master Carton	10 lb (4.5 kg) Easy Open Can 30 lb (13.6 kg) Master Carton
3/32 (2.4)	12 (305)	ED036502	ED035010 ED035011
1/8 (3.2)	14 (355)		
5/32 (4.0)	14 (355)		

DEPOSIT COMPOSITION⁽¹⁾

	%C	%Cr	%Ni	%Mo	%Mn
Requirements AWS E385-16	0.03 max	19.5 - 21.5	24.0 - 26.0	4.2 - 5.2	1.0 - 2.5
Typical Results⁽²⁾	0.02	20.4	24.9	4.8	1.4
	%Si	%P	%S	%Cu	FN
Requirements AWS E385-16	0.90 max	0.03 max	0.02 max	1.2 - 2.0	Not Required
Typical Results⁽²⁾	0.34	0.01	0.01	1.6	—

TYPICAL OPERATING PROCEDURES

Polarity ⁽³⁾	Current (Amps)			
	3/32 in (2.4 mm)	1/8 in (3.2 mm)	5/32 in (4.0 mm)	3/16 in (4.8 mm)
DC+	40-80	75-110	95-150	130-200
AC	40-80	75-110	95-150	130-200

⁽¹⁾Typical all weld metal. ⁽²⁾See test results disclaimer. ⁽³⁾Preferred polarity is listed first.

IMPORTANT: SPECIAL VENTILATION AND/OR EXHAUST REQUIRED

Fumes from the normal use of some welding products can contain significant quantities of components - such as chromium and manganese - which can lower the 5.0 mg/m³ maximum exposure guideline for general welding fume. BEFORE USE, READ AND UNDERSTAND THE SAFETY DATA SHEET (SDS) FOR THIS PRODUCT AND SPECIFIC INFORMATION PRINTED ON THE PRODUCT CONTAINER.

EXCALIBUR® 410-16

Stainless · AWS E410-16

KEY FEATURES

- Preheat and interpass temperatures greater than 400°F (200°C) are recommended during welding
- Great for overlay on carbon and low alloy steels

WELDING POSITIONS

All, except vertical down

CONFORMANCES

AWS A5.4:	E410-16
ASME SFA-A5.4:	E410-16

TYPICAL APPLICATIONS

- Surfacing Steel Mill Rolls
- Furnace and Burner Parts
- Turbine Parts
- Welding 410 and 410s Stainless Steels

DIAMETERS / PACKAGING

Diameter in (mm)	Length in (mm)	10 lb (4.5 kg) Tube 30 lb (13.6 kg) Master Carton
1/8 (3.2)	14 (355)	ED035012
5/32 (4.0)	14 (355)	ED035013
3/16 (4.8)	14 (355)	ED035014

DEPOSIT COMPOSITION⁽¹⁾

	%C	%Cr	%Ni	%Mo	%Mn
Requirements AWS E410-16	0.12 max	11.0 - 13.5	0.7 max	0.75 max	1.0 max
Typical Results⁽²⁾	0.08	12.2	0.2	0.01	0.7
	%Si	%P	%S	%Cu	
Requirements AWS E410-16	0.90 max	0.04 max	0.03 max	0.75 max	
Typical Results⁽²⁾	0.40	0.02	0.01	0.06	

TYPICAL OPERATING PROCEDURES

Polarity ⁽³⁾	Current (Amps)			
	3/32 in (2.4 mm)	1/8 in (3.2 mm)	5/32 in (4.0 mm)	3/16 in (4.8 mm)
DC+	40-80	75-110	95-150	130-200
AC	40-80	75-110	95-150	130-200

⁽¹⁾Typical all weld metal. ⁽²⁾See test results disclaimer. ⁽³⁾Preferred polarity is listed first.

IMPORTANT: SPECIAL VENTILATION AND/OR EXHAUST REQUIRED

Fumes from the normal use of some welding products can contain significant quantities of components - such as chromium and manganese - which can lower the 5.0 mg/m³ maximum exposure guideline for general welding fume. BEFORE USE, READ AND UNDERSTAND THE SAFETY DATA SHEET (SDS) FOR THIS PRODUCT AND SPECIFIC INFORMATION PRINTED ON THE PRODUCT CONTAINER.

EXCALIBUR® 410NiMo-16

Stainless · AWS E410NiMo-16

KEY FEATURES

- This electrode can be used to overlay mild and low alloy steels
- Preheat and inter-pass temperatures greater than 300°F (150°C) are recommended during welding
- Post-weld heat treatment should not exceed 1150°F (620°C) as higher temperatures may result in hardening

WELDING POSITIONS

All, except vertical down

CONFORMANCES

AWS A5.4:	E410NiMo-16
ASME SFA-A5.4:	E410NiMo-16

TYPICAL APPLICATIONS

- Turbines
- Valve Bodies
- High Pressure Piping
- Offshore
- Power Generation
- Welding CA6NM Stainless Steel

DIAMETERS / PACKAGING

Diameter in (mm)	Length in (mm)	10 lb (4.5 kg) Easy Open Can 30 lb (13.6 kg) Master Carton
1/8 [3.2]	14 [355]	ED035015
5/32 [4.0]	14 [355]	ED035016
3/16 [4.8]	14 [355]	ED035018

DEPOSIT COMPOSITION⁽¹⁾

	%C	%Cr	%Ni	%Mo	%Mn
Requirements AWS E410NiMo-16	0.06 max	11.0 - 12.5	4.0 - 5.0	0.40 - 0.70	1.0 max
Typical Results⁽²⁾	0.02	11.7	4.6	0.58	0.5
	%Si	%P	%S	%Cu	FN
Requirements AWS E410NiMo-16	0.90 max	0.04 max	0.03 max	0.75 max	Not Required
Typical Results⁽²⁾	0.37	0.02	0.01	0.07	–

TYPICAL OPERATING PROCEDURES

Polarity ⁽³⁾	Current (Amps)			
	3/32 in [2.4 mm]	1/8 in [3.2 mm]	5/32 in [4.0 mm]	3/16 in [4.8 mm]
DC+	40-80	75-110	95-150	130-200
AC	40-80	75-110	95-150	130-200

⁽¹⁾Typical all weld metal. ⁽²⁾See test results disclaimer. ⁽³⁾Preferred polarity is listed first.

IMPORTANT: SPECIAL VENTILATION AND/OR EXHAUST REQUIRED

Fumes from the normal use of some welding products can contain significant quantities of components - such as chromium and manganese - which can lower the 5.0 mg/m³ maximum exposure guideline for general welding fume. BEFORE USE, READ AND UNDERSTAND THE SAFETY DATA SHEET (SDS) FOR THIS PRODUCT AND SPECIFIC INFORMATION PRINTED ON THE PRODUCT CONTAINER.

EXCALIBUR® 630-16

Stainless · AWS E630-16

KEY FEATURES

- A precipitation hardening stainless steel covered electrode used for welding materials such as 17-4 and 17-7
- Can be used in the as welded condition or may be heat treated to obtain higher strength
- Mechanical properties of the alloy are greatly influenced by the heat treatment

WELDING POSITIONS

All, except vertical down

CONFORMANCES

AWS A5.4:	E630-16
ASME SFA-A5.4:	E630-16

TYPICAL APPLICATIONS

- Hydraulic Equipment
- Impellers
- Pump Shafts
- Welding 17-4 and 17-7 Stainless Steels

DIAMETERS / PACKAGING

Diameter in (mm)	Length in (mm)	8 lb (3.6 kg) Easy Open Can 24 lb (10.9 kg) Master Carton	10 lb (4.5 kg) Easy Open Can 30 lb (13.6 kg) Master Carton
3/32 (2.4)	12 (305)	ED035019	
1/8 (3.2)	14 (355)		ED035020
5/32 (4.0)	14 (355)		ED035021
3/16 (4.8)	14 (355)		ED035022

DEPOSIT COMPOSITION⁽¹⁾

	%C	%Cr	%Ni	%Mo	%Nb+Ta
Requirements AWS E630-16	0.05 max	16.00 - 16.75	4.5 - 5.0	0.75 max	0.15 - 0.30
Typical Results⁽²⁾	0.03	16.30	4.8	0.11	0.16
	%Mn	%Si	%P	%S	%Cu
Requirements AWS E630-16	0.25 - 0.75	0.75 max	0.04 max	0.03 max	3.25 - 4.00
Typical Results⁽²⁾	0.62	0.36	0.02	0.01	3.43

TYPICAL OPERATING PROCEDURES

Polarity ⁽³⁾	Current (Amps)			
	3/32 in (2.4 mm)	1/8 in (3.2 mm)	5/32 in (4.0 mm)	3/16 in (4.8 mm)
DC+	40-80	75-110	95-150	130-200
AC	40-80	75-110	95-150	130-200

⁽¹⁾Typical all weld metal. ⁽²⁾See test results disclaimer. ⁽³⁾Preferred polarity is listed first.

IMPORTANT: SPECIAL VENTILATION AND/OR EXHAUST REQUIRED

Fumes from the normal use of some welding products can contain significant quantities of components - such as chromium and manganese - which can lower the 5.0 mg/m³ maximum exposure guideline for general welding fume. BEFORE USE, READ AND UNDERSTAND THE SAFETY DATA SHEET (SDS) FOR THIS PRODUCT AND SPECIFIC INFORMATION PRINTED ON THE PRODUCT CONTAINER.

EXCALIBUR® 2209-16

Stainless · AWS E2209-16

KEY FEATURES

- Designed for welding 22% Cr Duplex Stainless Steels
- The welds offer excellent resistance to stress corrosion, cracking and pitting
- High strength welds and good corrosion resistance in a range of environments

WELDING POSITIONS

All, except vertical down

CONFORMANCES

AWS A5.4:	E2209-16
ASME SFA-A5.4:	E2209-16

TYPICAL APPLICATIONS

- Offshore
- Oil and Gas
- Chemical
- Petrochemical
- Welding 2205 Stainless Steels

DIAMETERS / PACKAGING

Diameter in (mm)	Length in (mm)	8 lb (3.6 kg) Easy Open Can 24 lb (10.9 kg) Master Carton	10 lb (4.5 kg) Easy Open Can 30 lb (13.6 kg) Master Carton
3/32 (2.4)	12 (305)	ED034985	ED034986
1/8 (3.2)	14 (355)		
5/32 (4.0)	14 (355)		
3/16 (4.8)	14 (355)		

DEPOSIT COMPOSITION⁽¹⁾

	%C	%Cr	%Ni	%Mo	%Mn	%Si
Requirements AWS E2209-16	0.04 max	21.5 - 23.5	8.5 - 10.5	2.5 - 3.5	0.5 - 2.0	1.0 max
Typical Results⁽²⁾	0.02	22.3	9.5	3.2	1.1	0.5
	%P	%S	%N	%Cu	FN	
Requirements AWS E2209-16	0.04 max	0.03 max	0.08 - 0.20	0.75 max	Not Required	
Typical Results⁽²⁾	0.02	0.01	0.16	0.06	30 - 60	

TYPICAL OPERATING PROCEDURES

Polarity ⁽³⁾	Current (Amps)			
	3/32 in (2.4 mm)	1/8 in (3.2 mm)	5/32 in (4.0 mm)	3/16 in (4.8 mm)
DC+	40-80	75-110	95-150	130-200
AC	40-80	75-110	95-150	130-200

⁽¹⁾Typical all weld metal. ⁽²⁾See test results disclaimer. ⁽³⁾Preferred polarity is listed first.

IMPORTANT: SPECIAL VENTILATION AND/OR EXHAUST REQUIRED

Fumes from the normal use of some welding products can contain significant quantities of components - such as chromium and manganese - which can lower the 5.0 mg/m³ maximum exposure guideline for general welding fume. BEFORE USE, READ AND UNDERSTAND THE SAFETY DATA SHEET (SDS) FOR THIS PRODUCT AND SPECIFIC INFORMATION PRINTED ON THE PRODUCT CONTAINER.

EXCALIBUR® 2594-16

Stainless · AWS E2594-16

KEY FEATURES

- A super-duplex grade electrode that provides matching chemistry and mechanical property characteristics to wrought super-duplex alloys such as 2507 and Zeron 100, as well as to super-duplex casting alloys (ATSM A890)
- High tensile and yield strength results, as well as superior resistance to Sulfide Corrosion Cracking (SCC) and pitting corrosion
- Great corrosion resistance in a range of environments

WELDING POSITIONS

All, except vertical down

CONFORMANCES

AWS A5.4:	E2594-16
ASME SFA-A5.4:	E2594-16

TYPICAL APPLICATIONS

- Process Pipework
- Pumps and Valves
- Pressure Vessels
- Welding 2507 and Zeron 100X Duplex Stainless Steels

DIAMETERS / PACKAGING

Diameter in (mm)	Length in (mm)	8 lb (3.6 kg) Easy Open Can 24 lb (10.9 kg) Master Carton	10 lb (4.5 kg) Easy Open Can 30 lb (13.6 kg) Master Carton
3/32 (2.4)	12 (305)	ED034989	ED034990
1/8 (3.2)	14 (355)		
5/32 (4.0)	14 (355)		
3/16 (4.8)	14 (355)		

DEPOSIT COMPOSITION⁽¹⁾

	%C	%Cr	%Ni	%Mo	%Mn	%Si
Requirements AWS E2594-16	0.04 max	24.0 - 27.0	8.0 - 10.5	3.5 - 4.5	0.5 - 2.0	1.00 max
Typical Results⁽²⁾	0.02	25.4	9.2	4.2	0.8	0.58
	%P	%S	%N	%Cu	FN	
Requirements AWS E2594-16	0.04 max	0.03 max	0.20 - 0.30	0.75 max	Not Required	
Typical Results⁽²⁾	0.01	0.01	0.22	0.07	30 - 60	

TYPICAL OPERATING PROCEDURES

Polarity ⁽³⁾	Current (Amps)			
	3/32 in (2.4 mm)	1/8 in (3.2 mm)	5/32 in (4.0 mm)	3/16 in (4.8 mm)
DC+	40-80	75-110	95-150	130-200
AC	40-80	75-110	95-150	130-200

⁽¹⁾Typical all weld metal. ⁽²⁾See test results disclaimer. ⁽³⁾Preferred polarity is listed first.

IMPORTANT: SPECIAL VENTILATION AND/OR EXHAUST REQUIRED

Fumes from the normal use of some welding products can contain significant quantities of components - such as chromium and manganese - which can lower the 5.0 mg/m³ maximum exposure guideline for general welding fume. BEFORE USE, READ AND UNDERSTAND THE SAFETY DATA SHEET (SDS) FOR THIS PRODUCT AND SPECIFIC INFORMATION PRINTED ON THE PRODUCT CONTAINER.

E16.8.2-15

Stainless · AWS E16-8-2-15

KEY FEATURES

- Basic pipe welding electrode for 3XXH stainless steel
- Suited to the most demanding vertical and overhead welding applications, including fixed pipework in the ASME 5G/6G positions

WELDING POSITIONS

All

CONFORMANCES

AWS A5.4	E16-8-2-15
ISO 3581-A	(E16 8 2 B)

TYPICAL APPLICATIONS

- Transfer lines
- Furnace parts
- Thick wall steam piping
- 308H, 316H Materials
- Gas
- Steam turbine plants
- Power Generation industries

DIAMETERS / PACKAGING

Diameter mm [in]	3.5kg (7.7lb) Easy Open Can	4.1kg (9.0lb) Easy Open Can	4.2kg (9.3lb) Easy Open Can
2.5 [3/32] 3.2 [1/8] 4.0 [5/32]	E168215-25-1	E168215-32-1	E168215-40-1

MECHANICAL PROPERTIES⁽¹⁾ – As Required per AWS A5.4

	Yield Strength ⁽²⁾ MPa (ksi)	Tensile Strength MPa (ksi)	Elongation %	Charpy V-Notch J (ft-lbf) @-100°C (-148°F)
Requirements AWS E16-8-2-15 As-Welded	-	550 (80)	35 min	-
Typical Results⁽³⁾ As-Welded	>420 (61)	>620 (90)	40	50 (37)

DEPOSIT COMPOSITION⁽¹⁾ – As Required per AWS A5.4

	%C	%Mn	%Si	%S	%P
Requirements AWS E16-8-2-15	0.04-0.08	0.5-2.5	0.60 max	0.03 max	0.03 max
Typical Results⁽³⁾	0.05	1.8	0.3	0.01	0.02
	%Cr	%Ni	%Mo	%Cu	%FN
Requirements AWS E16-8-2-15	14.5-16.5	7.5-9.5	1.0-2.0	0.5 max	1-6
Typical Results⁽³⁾	15.5	8.5	1.2	0.1	3

⁽¹⁾Typical all weld metal. ⁽²⁾Measured with 0.2% offset. ⁽³⁾See test results disclaimer.

IMPORTANT: SPECIAL VENTILATION AND/OR EXHAUST REQUIRED

Fumes from the normal use of some welding products can contain significant quantities of components - such as chromium and manganese - which can lower the 5.0 mg/m³ maximum exposure guideline for general welding fume. BEFORE USE, READ AND UNDERSTAND THE SAFETY DATA SHEET (SDS) FOR THIS PRODUCT AND SPECIFIC INFORMATION PRINTED ON THE PRODUCT CONTAINER.

SUPERMET™ 16.8.2

Stainless · AWS E16-8-2-17

KEY FEATURES

- Manufactured with controlled hydrogen and moisture resistant flux covering technology to ensure high resistance to weld porosity
- 3XXH Materials

WELDING POSITIONS

All

CONFORMANCES

AWS A5.4	E16-8-2-17
ISO 3581-A	[E 16 8 2 R]

TYPICAL APPLICATIONS

- 308H, 316H Materials
- Gas and steam turbine
- Petrochemical
- Chemical process plants
- Power generation industries

DIAMETERS / PACKAGING

Diameter mm [in]	3.9kg (8.6lb) Easy Open Can	4.4kg (9.7lb) Easy Open Can	4.5kg (9.9lb) Easy Open Can
2.5 (3/32)	SM1682-25	SM1682-32	SM1682-40
3.2 (1/8)			
4.0 (5/32)			

MECHANICAL PROPERTIES⁽¹⁾ – As Required per AWS A5.4

	Yield Strength ⁽²⁾ MPa [ksi]	Tensile Strength MPa [ksi]	Elongation %		Charpy V-Notch J [ft-lbf]
			4.0 dia	5.0 dia	
Requirements AWS E16-8-2-17 As-Welded	-	550 (80)	35	25 min	-
Typical Results⁽³⁾ As-Welded	>410 (60)	>620 (90)	42	42	>50 (37)

DEPOSIT COMPOSITION⁽¹⁾ – As Required per AWS A5.4

	%C	%Mn	%Si	%S	%P
Requirements AWS E16-8-2-17	0.08 max	2.5 max	0.60 max	0.03 max	0.03 max
Typical Results⁽³⁾	0.05	1.0	0.45	0.01	0.02
	%Cr	%Ni	%Mo	%Cu	FN
Requirements AWS E16-8-2-17	14.5-16.5	7.5-9.5	1.0-2.0	0.75 max	1-6
Typical Results⁽³⁾	15.5	8.5	1.1	0.1	3

⁽¹⁾Typical all weld metal. ⁽²⁾Measured with 0.2% offset. ⁽³⁾See test results disclaimer.

IMPORTANT: SPECIAL VENTILATION AND/OR EXHAUST REQUIRED

Fumes from the normal use of some welding products can contain significant quantities of components - such as chromium and manganese - which can lower the 5.0 mg/m³ maximum exposure guideline for general welding fume. BEFORE USE, READ AND UNDERSTAND THE SAFETY DATA SHEET (SDS) FOR THIS PRODUCT AND SPECIFIC INFORMATION PRINTED ON THE PRODUCT CONTAINER.

THERMET™ 800Nb

Austenitic Heat Resisting Consumable

KEY FEATURES

- Controlled carbon and niobium for optimum corrosion resistance and creep performance
- Designed to eliminate thermal fatigue and shock resistance at temperatures up to 1000°C (1832°F)
- Designed to meet deposit composition of type 800 cast at wrought alloys

TYPICAL APPLICATIONS

- Fabrication of muffles, radiant tubes, and heat treatment trays
- Petrochemical industry
- Nuclear engineering industries
- Welding alloy 800, 800H, 800HT

WELDING POSITIONS

All, except vertical down

DIAMETERS / PACKAGING

Diameter mm (in)	Length mm (in)	3.9kg (8.6lb) Carton	4.4kg (9.7lb) Carton	4.5kg (9.9lb) Carton
2.5 (3/32)	13.78 (350)	INTH800NB-25	INTH800NB-32-1	INTH800NB-40-1
3.2 (1/8)	13.78 (350)			
4.0 (5/32)	13.78 (350)			

MECHANICAL PROPERTIES⁽¹⁾

	Tensile Strength MPa (ksi)	0.2% Proof Stress MPa (ksi)	Elongation %	Reduction of area	Impact energy +20°C J	Hardness HV
Typical Results ⁽²⁾ As-Welded	615 (107)	410 (80)	>32	46	>55	170-220

DEPOSIT COMPOSITION⁽¹⁾

	%C	%Mn	%Si	%S	%P
Requirements	0.06-0.12	1.6-4.5	0.6 max	0.02 max	0.03 max
Typical Results ⁽³⁾ - (Weld metal wt. %)	0.1	2.5	0.3	0.007	0.015
	%Cr	%Ni	%Nb	%Mo	%Cu
Requirements	19.0-23.0	30.0-35.0	0.8-1.5	0.5 max	0.5 max
Typical Results ⁽³⁾ - (Weld metal wt. %)	21	32	1.3	0.4	0.15

TYPICAL OPERATING PROCEDURES

Diameter mm (in)	Polarity	Amp Range
3.2 (1/8)	DC+	75-120A
4.0 (5/32)	DC+	100-155A
5.0 (3/16)	DC+	130-210A

⁽¹⁾Typical all weld metal. ⁽²⁾Measured with 0.2% offset. ⁽³⁾See test results disclaimer.

IMPORTANT: SPECIAL VENTILATION AND/OR EXHAUST REQUIRED

Fumes from the normal use of some welding products can contain significant quantities of components - such as chromium and manganese - which can lower the 5.0 mg/m³ maximum exposure guideline for general welding fume. BEFORE USE, READ AND UNDERSTAND THE SAFETY DATA SHEET (SDS) FOR THIS PRODUCT AND SPECIFIC INFORMATION PRINTED ON THE PRODUCT CONTAINER.

ULTRAMET® 308LCF

Stainless · AWS E308L-16

KEY FEATURES

- Controlled Low Ferrite (Range 3-6)
- Charpy V-Notch test results capable of exceeding 27 J (20 ft-lbf) @ -196°C (-320°F)
- Exceeds 15 mils (0.38 mm) of lateral expansion @ -196°C (-320°F)
- Batch Managed Inventory
- Q2 Lot® - Certificates showing actual deposit composition available online

WELDING POSITIONS

All

CONFORMANCES

AWS A5.4:	E308L-16
ASME SFA 5.4:	E308L-16

TYPICAL APPLICATIONS

- LNG Storage
- Cryogenic Vessels and Piping

TYPICAL BASE METALS

- 304L stainless steel
- 18/8 steels with service temperatures down to -196°C (-320°F)

DIAMETERS / PACKAGING

Diameter mm (in)	4.4kg (9.7lb) Carton	4.5kg (9.9lb) Carton
3.2 (1/8) 4.0 (5/32)	UM308LCF-32-1	UM308LCF-40-1

MECHANICAL PROPERTIES⁽¹⁾ – As Required per AWS A5.4

	Yield Strength ⁽²⁾ MPa (ksi)	Tensile Strength MPa (ksi)	Elongation %	Charpy V-Notch J (ft-lb) -196°C (-320°F)	Lateral Expansion mm (mils) -196°C (-320°F)
Requirements AWS 5.4: E308L-16	Not Specified	520 (75) min	30 min	Not Specified	Not Specified
Typical Results⁽³⁾	445 (65)	600 (87)	50	45 (33)	0.50 (19.7)

DEPOSIT COMPOSITION⁽¹⁾ – As Required per AWS A5.4

	%C	%Mn	%Si	%S	%P
Requirements	0.04 max	0.5 - 2.5	1.00 max	0.03 max	0.03 max
Typical Results⁽³⁾	< 0.025	1.0	0.60	0.01	0.02
	%Cr	%Ni	%Mo	%Cu	%FN
Requirements	18.0-21.0	9.0-11.0	0.75 max	0.75 max	Not Specified
Typical Results⁽³⁾	18.5	10.0	0.1	<0.1	3

TYPICAL OPERATING PROCEDURES

Polarity ⁽⁴⁾	Current (Amps)	
	2.5 mm (3/32 in)	3.2 mm (1/8 in)
DC+	60-90	75-120
AC	40-80	75-120

⁽¹⁾Typical all weld metal. ⁽²⁾Measured with 0.2% offset. ⁽³⁾See test results disclaimer. ⁽⁴⁾Preferred polarity is listed first.

IMPORTANT: SPECIAL VENTILATION AND/OR EXHAUST REQUIRED

Fumes from the normal use of some welding products can contain significant quantities of components - such as chromium and manganese - which can lower the 5.0 mg/m³ maximum exposure guideline for general welding fume. BEFORE USE, READ AND UNDERSTAND THE SAFETY DATA SHEET (SDS) FOR THIS PRODUCT AND SPECIFIC INFORMATION PRINTED ON THE PRODUCT CONTAINER.

ULTRAMET B™ 316NF

Stainless · Similar to AWS A5.4 (E316LMn-15) · E 18 15 3 L B 4 2

KEY FEATURES

- Controlled carbon and niobium for optimum corrosion resistance and creep performance
- Designed to eliminate thermal fatigue and shock resistance at temperatures up to 1000°C (1832°F)

WELDING POSITIONS

All, except vertical down

CONFORMANCES

ISO 3581-A E 18 15 3 L B 4 2

* Similar to E316LMn-15

TYPICAL APPLICATIONS

- Fabrication of fittings for minesweepers
- Offshore industry – Downhole instrument collars
- LPG & LNG storage vessels

DIAMETERS / PACKAGING

Diameter mm (in)	Length mm (in)	4.4kg (9.7lb) Carton	4.5kg (9.9lb) Carton
3.2 (1/8) 4.0 (5/32)	350 (13.78) 350 (13.78)	UMB316NF-32-1	UMB316NF-40-1

MECHANICAL PROPERTIES⁽¹⁾

	Tensile Strength MPa (ksi)	0.2% Proof Stress MPa (ksi)	Elongation %	Reduction of area	Charpy V-Notch J (ft-lb) -196°C (-320°F) J	Lateral Expansion mm (mils) -196°C (-320°F)
Typical Results⁽²⁾ As-Welded	610 (89)	440 (64)	38	50	50	0.6 (24)

DEPOSIT COMPOSITION⁽¹⁾ – As Required per Similar to AWS A5.4

	%C	%Mn	%Si	%S	%P
Requirements per E 18 15 3 L B 4 2	0.04 max	2.5-4.0	0.9 max	0.025 max	0.030 max
Typical Results⁽²⁾ (Weld metal wt. %)	<0.03	3.5	0.4	0.01	0.02
	%Cr	%Ni	%Mo	%Cu	%N
Requirements per E 18 15 3 L B 4 2	16.5-19.5	14.0-17.0	2.5-3.5	0.5 max	0.1-0.2
Typical Results⁽²⁾ (Weld metal wt. %)	18	16	2.8	<0.1	0.15

TYPICAL OPERATING PROCEDURES

Diameter mm (in)	Polarity	Amp Range
3.2 (1/8)	DC+	75-120A
4.0 (5/32)	DC+	100-155A
5.0 (3/16)	DC+	130-210A

⁽¹⁾ Typical all weld metal. ⁽²⁾ Measured with 0.2% offset. ⁽³⁾ See test results disclaimer

IMPORTANT: SPECIAL VENTILATION AND/OR EXHAUST REQUIRED

Fumes from the normal use of some welding products can contain significant quantities of components - such as chromium and manganese - which can lower the 5.0 mg/m³ maximum exposure guideline for general welding fume. BEFORE USE, READ AND UNDERSTAND THE SAFETY DATA SHEET (SDS) FOR THIS PRODUCT AND SPECIFIC INFORMATION PRINTED ON THE PRODUCT CONTAINER.

BLUE MAX® MIG 307_MOD

Stainless

KEY FEATURES

- Austenitic stainless steel
- 7% Manganese (Mn) increases resistance to hot cracking between dissimilar steels
- Q2 Lot* - Certificates showing actual wire composition and calculated ferrite number (FN) available online

WELDING POSITIONS

All

CONFORMANCES

ISO 14343-A: G 18 8 Mn

TYPICAL APPLICATIONS

- Automotive exhaust systems
- Armor Plate (military)
- Designed for joining dissimilar stainless steels
- Work hardening manganese steel

SHIELDING GAS

Short Circuiting Transfer
90% He / 7.5% Argon / 2.5% CO₂
Axial Spray Transfer
98% Argon / Balance O₂

DIAMETERS / PACKAGING

Diameter in (mm)	33 lb (15 kg) Steel Spool
0.045 (1.2)	ED036050

WIRE COMPOSITION⁽¹⁾

	%C	%Mn	%Si	%Cr	%Ni
Typical Results ⁽²⁾	0.08	7.1	0.80	18.8	8.6
	%S	%P	%Mo	%Cu	%FN
Typical Results ⁽²⁾	0.009	0.023	-	-	-

TYPICAL OPERATING PROCEDURES

Diameter in (mm)	Voltage (volts)	Amperage	Gas Flow	Gas
0.045 (1.1)	28-32	180-250	30-50 CFH	98/2 (Ar/O ₂)

⁽¹⁾Typical wire composition. ⁽²⁾See test results disclaimer

IMPORTANT: SPECIAL VENTILATION AND/OR EXHAUST REQUIRED

Fumes from the normal use of some welding products can contain significant quantities of components - such as chromium and manganese - which can lower the 5.0 mg/m³ maximum exposure guideline for general welding fume. BEFORE USE, READ AND UNDERSTAND THE SAFETY DATA SHEET (SDS) FOR THIS PRODUCT AND SPECIFIC INFORMATION PRINTED ON THE PRODUCT CONTAINER.

BLUE MAX[®] MIG 308H

Stainless · AWS ER308H

KEY FEATURES

- Provides a higher carbon deposition (minimum of 0.04% carbon) than Blue Max MIG 308L
- The higher carbon deposit provides creep strength and higher tensile strength at elevated service temperatures
- Q2 Lot[®] - Certificate showing actual wire composition and calculated ferrite number (FN) available online

WELDING POSITIONS

All

CONFORMANCES

AWS A5.9: ER308, ER308H

ASME SFA-5.9: ER308, ER308H

TYPICAL APPLICATIONS

- Chemical
- Petrochemical Industries
- Distillery
- Catalytic Crackers
- Pulp and Paper
- Welding 302/304H/305 Stainless Steels
- Restaurant Industries

SHIELDING GAS

Short Circuiting Transfer
90% He / 7.5% Argon / 2.5% CO₂
Axial Spray Transfer
98% Argon / Balance O₂

DIAMETERS / PACKAGING

Diameter in (mm)	33 lb (15 kg) Steel Spool	500 lb (227 kg) Accu-Trak [®] Drum
0.030 (0.8)	ED035038	
0.035 (0.9)	ED035039	
0.045 (1.1)	ED035040	ED035041
1/16 (1.6)	ED035042	

WIRE COMPOSITION⁽¹⁾ – As Required per AWS A5.9

	%C ⁽²⁾	%Cr	%Ni	%Mo	%Mn
Requirements AWS ER308H	0.04 - 0.08	19.5 - 22.0	9.00 - 11.00	0.50 max	1.0 - 2.5
Typical Results⁽²⁾	0.06	19.9	9.7	0.07	1.8
	%Si	%P	%S	%Cu	FN
Requirements AWS ER308H	0.30 - 0.65	0.03 max	0.03 max	0.75 max	Not Required
Typical Results⁽²⁾	0.44	0.02	0.006	0.10	7

TYPICAL OPERATING PROCEDURES

Diameter in (mm)	Voltage [volts]	Amperage	Gas Flow	Gas
0.030 (0.8)	26-29	160-210	30-50 CFH	98/2 (Ar/O ₂)
0.035 (0.9)	26-29	160-210	30-50 CFH	90/7.5/2.5
0.045 (1.1)	28-32	180-250	30-50 CFH	(He/Ar/CO ₂)
0.062 (1.6)	29-33	200-280	30-50 CFH	

⁽¹⁾Typical wire chemistry. ⁽²⁾See test results disclaimer. ⁽³⁾AWS Requirements for ER308 is 0.08% max carbon.

IMPORTANT: SPECIAL VENTILATION AND/OR EXHAUST REQUIRED

Fumes from the normal use of some welding products can contain significant quantities of components - such as chromium and manganese - which can lower the 5.0 mg/m³ maximum exposure guideline for general welding fume. BEFORE USE, READ AND UNDERSTAND THE SAFETY DATA SHEET (SDS) FOR THIS PRODUCT AND SPECIFIC INFORMATION PRINTED ON THE PRODUCT CONTAINER.

BLUE MAX[®] MIG 308LSI

Stainless · AWS ER308Si, ER308LSi

KEY FEATURES

- High silicon level for increased puddle fluidity and toe wetting
- Proprietary surface lubricant for steady feeding and arc stability
- Versatile electrode designed to weld CrNi austenitic stainless steels
- Used to primarily weld equipment made with 304 type stainless steel
- Higher silicon content improves wetting of the weld metal and potentially higher travel speeds compared to standard 308L products
- Q2 Lot[®] - Certificate showing actual wire composition and calculated ferrite number (FN) available online

WELDING POSITIONS

All

CONFORMANCES

AWS A5.9:	ER308Si, ER308LSi
ASME SFA-A5.9	ER308Si, ER308LSi
CWB/CSA:	ER308Si, ER308LSi
EN ISO 14343-B:	SS308LSi
ABS:	ER308Si, ER308LSi

TYPICAL APPLICATIONS

- 304 and 304L stainless steels
- Common austenitic stainless steels referred to as “18-8” steels
- ASTM A743 or A744 Types CF-8 and CF-3
- Performs exceptionally at high wire feed speeds

SHIELDING GAS

Short Circuiting Transfer

90% He / 7.5% Argon / 2.5% CO₂

Axial Spray Transfer

98% Argon / Balance O₂

DIAMETERS / PACKAGING

Diameter in (mm)	25 lb (11.3 kg) Plastic Spool	33 lb (15 kg) Plastic Spool	33 lb (15 kg) Steel Spool	250 lb (113 kg) Accu-Trak [®] Drum	500 lb (227 kg) Accu-Trak [®] Drum	1000 lb (454 kg) Precise-Trak [™] Reel
0.030 (0.8)		ED037252				
0.035 (0.9)		ED037250	ED035058	ED035060	ED029768	ED032834
0.045 (1.1)		ED037251		ED035063	ED029769	
1/16 (1.6)	ED019294					

MECHANICAL PROPERTIES⁽¹⁾ – As Required per AWS A5.9

	Yield Strength ⁽²⁾ MPa (ksi)	Tensile Strength MPa (ksi)	Elongation %	Ferrite Number
Typical Results ⁽³⁾ - As-Welded	455 (66)	635 (92)	46	10

⁽¹⁾Typical all weld metal. ⁽²⁾Measured with 0.2% offset. ⁽³⁾See test results disclaimer.

WIRE COMPOSITION⁽¹⁾ – As Required per AWS A5.9

	%C ⁽⁴⁾	%Cr	%Ni	%Mo	%Mn
Requirements - AWS ER308LSi	0.03 max	19.5-22.0	9.0-11.0	0.75 max	1.0-2.5
Typical Results⁽³⁾	0.01	19.9	10.0	0.16	2.1
	%Si	%P	%S	%N ⁽⁵⁾	%Cu
Requirements - AWS ER308LSi	0.65-1.00	0.03 max	0.03 max	Not Specified	0.75 max
Typical Results⁽³⁾	0.88	0.02	0.01	0.05	0.17

TYPICAL OPERATING PROCEDURES

Diameter, Polarity Shielding Gas	CTWD ⁽⁶⁾ mm (in)	Wire Feed Speed m/min (in/min)	Voltage (Volts)	Approx. Current (Amps)	Deposition Rate kg/hr (lb/hr)	
Short Circuit Transfer						
0.035 in (0.9 mm), DC+ 90% He / 7-1/2% Ar / 2-1/2% CO ₂	13 (1/2)	3.0 (120)	19-20	55	0.9 (2.0)	
	13 (1/2)	4.6 (180)	19-20	85	1.4 (3.0)	
	13 (1/2)	5.8 (230)	20-21	105	1.8 (3.9)	
	13 (1/2)	7.6 (300)	20-21	125	2.3 (5.0)	
	13 (1/2)	8.9 (350)	21-22	140	2.7 (5.9)	
	13 (1/2)	10.2 (400)	22-23	160	3.1 (6.7)	
0.045 in (1.1 mm), DC+ 90% He / 7-1/2% Ar / 2-1/2% CO ₂	13 (1/2)	2.5 (100)	19-20	100	1.1 (2.8)	
	13 (1/2)	3.2 (125)	19-20	120	1.5 (3.5)	
	13 (1/2)	3.8 (150)	21	135	1.7 (4.2)	
	13 (1/2)	4.4 (175)	21	140	2.0 (4.8)	
	13 (1/2)	5.6 (220)	22	170	2.6 (6.1)	
	13 (1/2)	6.4 (250)	22-23	175	2.9 (6.9)	
13 (1/2)	7.0 (275)	22-23	185	3.2 (7.6)		
	Axial Spray Transfer					
	0.035 in (0.9 mm), DC+ 98% Ar/2% O ₂	13 (1/2)	10.2 (400)	22	180	3.1 (6.7)
		13 (1/2)	10.8 (425)	23	190	3.3 (7.1)
		13 (1/2)	11.4 (450)	23	200	3.5 (7.5)
		13 (1/2)	12.1 (475)	23	210	3.7 (8.0)
0.045 in (1.1 mm), DC+ 98% Ar/2% O ₂	13 (1/2)	6.1 (240)	23	195	2.8 (6.6)	
	13 (1/2)	6.6 (260)	24	230	3.0 (7.2)	
	13 (1/2)	7.6 (300)	24	240	3.5 (8.3)	
	13 (1/2)	8.3 (325)	25	250	3.8 (9.0)	
	13 (1/2)	9.1 (360)	25	260	4.2 (10.0)	
1/16 in (1.6 mm), DC+ 98% Ar/2% O ₂	19 (3/4)	4.4 (175)	25	260	4.3 (9.2)	
	19 (3/4)	5.1 (200)	26	310	4.9 (10.5)	
	19 (3/4)	6.4 (250)	26	330	6.2 (13.1)	
	19 (3/4)	7.0 (275)	27	360	6.8 (14.4)	
	19 (3/4)	7.6 (300)	28	390	7.4 (15.8)	

⁽¹⁾Typical all weld metal. ⁽²⁾Measured with 0.2% offset. ⁽³⁾See test results disclaimer ⁽⁴⁾AWS Requirements for ER308Si is 0.08% max carbon. ⁽⁵⁾Included in 0.50% max. for other elements not specified.

⁽⁶⁾To estimate ESO, subtract 1/8 in (3 mm) from CTWD.

IMPORTANT: SPECIAL VENTILATION AND/OR EXHAUST REQUIRED

Fumes from the normal use of some welding products can contain significant quantities of components - such as chromium and manganese - which can lower the 5.0 mg/m³ maximum exposure guideline for general welding fume. BEFORE USE, READ AND UNDERSTAND THE SAFETY DATA SHEET (SDS) FOR THIS PRODUCT AND SPECIFIC INFORMATION PRINTED ON THE PRODUCT CONTAINER.

BLUE MAX[®] MIG 308L

Stainless · AWS ER308L

KEY FEATURES

- Reduced carbon levels (0.03% max) offer increased resistance to inter-granular corrosion
- Q2 Lot[®] - Certificate showing actual wire composition and calculated ferrite number (FN) available online

WELDING POSITIONS

All

CONFORMANCES

AWS A5.9:	ER308, ER308L
ASME SFA-5.9:	ER308, ER308L
CWB/CSA:	ER308, ER308L
ABS:	ER308, ER308L

TYPICAL APPLICATIONS

- Designed for welding 304/304L Stainless Steels
- ASTM A743 or 744 Types CF-8 and CF-3 castings

SHIELDING GAS

Short Circuiting Transfer
90% He / 7.5% Argon / 2.5% CO₂
Axial Spray Transfer
98% Argon / Balance O₂

DIAMETERS / PACKAGING

Diameter in (mm)	33 lb (15 kg) Steel Spool	250 lb (113 kg) Accu-Trak [®] Drum	500 lb (227 kg) Accu-Trak [®] Drum
0.030 (0.8)	ED035043		
0.035 (0.9)	ED035045	ED035048	ED035049
0.045 (1.1)	ED035051		ED035054
1/16 (1.6)	ED035056		

WIRE COMPOSITION⁽¹⁾ – As Required per AWS A5.9

	%C ⁽²⁾	%Cr	%Ni	%Mo	%Mn
Requirements AWS ER308L	0.03 max	19.5 - 22.0	9.00 - 11.00	0.75 max	1.0 - 2.5
Typical Results⁽²⁾	0.01	19.7	9.7	0.17	1.7
	%Si	%P	%S	%Cu	FN
Requirements AWS ER308L	0.30 - 0.65	0.03 max	0.03 max	0.75 max	Not Required
Typical Results⁽²⁾	0.37	0.02	0.01	0.18	8 - 14

TYPICAL OPERATING PROCEDURES

Diameter in (mm)	Voltage (volts)	Amperage	Gas Flow	Gas
0.035 (0.9)	26-29	160-210	30-50 CFH	98/2 (Ar/O ₂)
0.045 (1.1)	28-32	180-250	30-50 CFH	
0.062 (1.6)	29-33	200-280	30-50 CFH	

⁽¹⁾Typical wire chemistry. ⁽²⁾See test results disclaimer. ⁽³⁾AWS Requirements for ER308 is 0.08% max carbon.

IMPORTANT: SPECIAL VENTILATION AND/OR EXHAUST REQUIRED

Fumes from the normal use of some welding products can contain significant quantities of components - such as chromium and manganese - which can lower the 5.0 mg/m³ maximum exposure guideline for general welding fume. BEFORE USE, READ AND UNDERSTAND THE SAFETY DATA SHEET (SDS) FOR THIS PRODUCT AND SPECIFIC INFORMATION PRINTED ON THE PRODUCT CONTAINER.

BLUE MAX[®] MIG 308LCF

Stainless · AWS ER308L

KEY FEATURES

- Controlled Low Ferrite (Range 3-6 FN)
- Charpy V-Notch test results capable of exceeding 27 J (20 ft-lbf) @ -196°C (-320°F)
- Exceeds 15 mils (0.38 mm) of lateral expansion @ -196°C (-320°F)
- Q2 Lot[®] - Certificates showing actual wire chemistry available online

WELDING POSITIONS

All

SHIELDING GAS

98% Argon / 2% Oxygen

CONFORMANCES

AWS A5.9: ER308, ER308L

ASME SFA-5.9: ER308, ER308L

TYPICAL APPLICATIONS

- LNG Storage
- Cryogenic Vessels and Piping

TYPICAL BASE METALS

- 304L stainless steel
- 18/8 steels with service temperatures down to -196°C (-320°F)

DIAMETERS / PACKAGING

Diameter in (mm)	33 lb (15kg) Steel Spool
0.035 (0.9)	ED034909
0.045 (1.1)	ED034910
1/16 (1.6)	ED038023

WIRE COMPOSITION⁽¹⁾ – As Required per AWS A5.9

	%C	%Cr	%Ni	%Mo	%Mn
Requirements AWS ER308L	0.03 max	19.5 - 22.0	9.00 - 11.00	0.75 max	1.0 - 2.5
Typical Results⁽²⁾	0.01	19.7	9.7	0.17	1.7
	%Si	%P	%S	%Cu	FN
Requirements AWS ER308L	0.30 - 0.65	0.03 max	0.03 max	0.75 max	Not Required
Typical Results⁽²⁾	0.37	0.02	0.01	0.18	3-6

MECHANICAL PROPERTIES⁽³⁾

	Yield Strength ⁽²⁾ MPa (ksi)	Tensile Strength MPa (ksi)	Elongation %	Charpy V-Notch J (ft-lbf) -196°C (-320°F)	Lateral Expansion mils (mm) -196°C (-320°F)
Typical Results⁽³⁾ As-Welded with 98% Ar/2% O ₂	430 (63)	600 (88)	35	34 (47)	24 (0.61)

⁽¹⁾Typical wire composition ⁽²⁾Measured with 0.2% offset ⁽³⁾See test results disclaimer

IMPORTANT: SPECIAL VENTILATION AND/OR EXHAUST REQUIRED

Fumes from the normal use of some welding products can contain significant quantities of components - such as chromium and manganese - which can lower the 5.0 mg/m³ maximum exposure guideline for general welding fume. BEFORE USE, READ AND UNDERSTAND THE SAFETY DATA SHEET (SDS) FOR THIS PRODUCT AND SPECIFIC INFORMATION PRINTED ON THE PRODUCT CONTAINER.

BLUE MAX[®] MIG 309LSI

Stainless · AWS ER309Si, ER309LSi

KEY FEATURES

- High silicon level for increased puddle fluidity and toe wetting
- Proprietary surface lubricant for steady feeding and arc stability
- Controlled ferrite content for maximum corrosion resistance
- The same composition as Blue Max[®] MIG 309L with higher silicon content to improve the bead appearance and increase welding ease
- Excellent contour of the weld minimizes the need for grinding
- Q2 Lot[®] - Certificate showing actual wire composition and calculated ferrite number (FN) available online

WELDING POSITIONS

All

CONFORMANCES

AWS A5.9:	ER309Si, ER309LSi
ASME SFA-A5.9:	ER309Si, ER309LSi
CWB/CSA:	ER309LSi
EN ISO 14343-B:	SS309LSi
ABS:	ER309Si, ER309LSi

TYPICAL APPLICATIONS

- Designed for joining stainless steel to mild or low alloy steel
- Performs exceptionally at high wire feed speeds

SHIELDING GAS

Short Circuiting Transfer:
90% Helium / 75% Argon / 2.5% CO₂

Axial Spray Transfer:
98% Argon / 2% Oxygen

DIAMETERS / PACKAGING

Diameter in (mm)	33 lb (15 kg) Plastic Spool	33 lb (15 kg) Steel Spool	250 lb (113 kg) Accu-Trak [®] Drum	500 lb (227 kg) Accu-Trak [®] Drum
0.030 (0.8)		ED035076		
0.035 (0.9)	ED037291	ED035077	ED035078	ED029770
0.045 (1.1)	ED037292	ED035080		ED029771
1/16 (1.6)	ED037293			

MECHANICAL PROPERTIES⁽¹⁾ – As Required per AWS A5.9

	Yield Strength ⁽²⁾ MPa (ksi)	Tensile Strength MPa (ksi)	Elongation %	Ferrite Number
Typical Results⁽³⁾ - As-Welded	450 (65)	595 (86)	42	11

⁽¹⁾Typical wire composition. ⁽²⁾Measured with 0.2% offset ⁽³⁾See test results disclaimer.

WIRE COMPOSITION⁽¹⁾ – As Required per AWS A5.9

	%C ⁽⁴⁾	%Cr	%Ni	%Mo	%Mn
Requirements - AWS ER309LSi	0.03 max	23.0-25.0	12.0-14.0	0.75 max	1.0-2.5
Typical Results⁽²⁾	0.03	23.5	13.7	0.28	2.0
	%Si	%P	%S	%N ⁽³⁾	%Cu
Requirements - AWS ER309LSi	0.65-1.00	0.03 max	0.03 max	Not Specified	0.75 max
Typical Results⁽²⁾	0.89	0.02	0.01	0.06	0.22

TYPICAL OPERATING PROCEDURES

Diameter, Polarity Shielding Gas	CTWD ⁽⁵⁾ mm (in)	Wire Feed Speed m/min (in/min)	Voltage (Volts)	Approx. Current (Amps)	Deposition Rate kg/hr (lb/hr)
-------------------------------------	--------------------------------	-----------------------------------	--------------------	---------------------------	----------------------------------

Short Circuit Transfer

0.035 in (0.9 mm), DC+ 90% He / 7-1/2% Ar / 2-1/2% CO ₂	13 (1/2)	3.0 (120)	19-20	55	0.9 (2.0)
	13 (1/2)	4.6 (180)	19-20	85	1.4 (3.0)
	13 (1/2)	5.8 (230)	20-21	105	1.8 (3.9)
	13 (1/2)	7.6 (300)	20-21	125	2.3 (5.0)
	13 (1/2)	8.9 (350)	21-22	140	2.7 (5.9)
	13 (1/2)	10.2 (400)	22-23	160	3.1 (6.7)
0.045 in (1.1 mm), DC+ 90% He / 7-1/2% Ar / 2-1/2% CO ₂	13 (1/2)	2.5 (100)	19-20	100	1.1 (2.8)
	13 (1/2)	3.2 (125)	19-20	120	1.5 (3.5)
	13 (1/2)	3.8 (150)	21	135	1.7 (4.2)
	13 (1/2)	4.4 (175)	21	140	2.0 (4.8)
	13 (1/2)	5.6 (220)	22	170	2.6 (6.1)
	13 (1/2)	6.4 (250)	22-23	175	2.9 (6.9)
13 (1/2)	7.0 (275)	22-23	185	3.2 (7.6)	

Axial Spray Transfer

0.035 in (0.9 mm), DC+ 98% Ar/2% O ₂	13 (1/2)	10.2 (400)	22	180	3.1 (6.7)
	13 (1/2)	10.8 (425)	23	190	3.3 (7.1)
	13 (1/2)	11.4 (450)	23	200	3.5 (7.5)
	13 (1/2)	12.1 (475)	23	210	3.7 (8.0)
0.045 in (1.1 mm), DC+ 98% Ar/2% O ₂	13 (1/2)	6.1 (240)	23	195	2.8 (6.6)
	13 (1/2)	6.6 (260)	24	230	3.0 (7.2)
	13 (1/2)	7.6 (300)	24	240	3.5 (8.3)
	13 (1/2)	8.3 (325)	25	250	3.8 (9.0)
	13 (1/2)	9.1 (360)	25	260	4.2 (10.0)
1/16 in (1.6 mm), DC+ 98% Ar/2% O ₂	19 (3/4)	4.4 (175)	25	260	4.3 (9.2)
	19 (3/4)	5.1 (200)	26	310	4.9 (10.5)
	19 (3/4)	6.4 (250)	26	330	6.2 (13.1)
	19 (3/4)	7.0 (275)	27	360	6.8 (14.4)
	19 (3/4)	7.6 (300)	28	390	7.4 (15.8)

⁽¹⁾Typical wire composition. ⁽²⁾Measured with 0.2% offset ⁽³⁾See test results disclaimer ⁽⁴⁾AWS Requirement for ER309Si is 0.12% max. carbon. ⁽⁵⁾Included in 0.50% max. for other elements not specified.

⁽⁶⁾To estimate ESO, subtract 1/8 in (3 mm) from CTWD.

IMPORTANT: SPECIAL VENTILATION AND/OR EXHAUST REQUIRED

Fumes from the normal use of some welding products can contain significant quantities of components - such as chromium and manganese - which can lower the 5.0 mg/m³ maximum exposure guideline for general welding fume. BEFORE USE, READ AND UNDERSTAND THE SAFETY DATA SHEET (SDS) FOR THIS PRODUCT AND SPECIFIC INFORMATION PRINTED ON THE PRODUCT CONTAINER.

BLUE MAX® MIG 309L

Stainless · AWS ER309L

KEY FEATURES

- Reduced carbon levels (0.03% max) offer increased resistance to inter-granular corrosion
- Excellent corrosion resistance
- Q2 Lot® - Certificate showing actual wire composition and calculated ferrite number (FN) available online

WELDING POSITIONS

All

CONFORMANCES

AWS A5.9:	ER309, ER309L
ASME SFA-5.9:	ER309, ER309L
CWB/CSA:	ER309, ER309L
ABS:	ER309, ER309L

TYPICAL APPLICATIONS

- Ideal for joining stainless steels to themselves or to carbon or low alloy steels, and can be used at temperatures of up to 700°F (371°C)

SHIELDING GAS

Short Circuiting Transfer:
90% Helium / 75% Argon / 2.5% CO₂

Axial Spray Transfer:
98% Argon/ 2% Oxygen

DIAMETERS / PACKAGING

Diameter in (mm)	33 lb (15 kg) Steel Spool	600 lb (272 kg) Accu-Trak® Drum
0.035 (0.9)	ED035071	
0.045 (1.1)	ED035072	
0.047 (1.2)		ED036579
1/16 (1.6)	ED035074	

WIRE COMPOSITION⁽¹⁾ – As Required per AWS A5.9

	%C	%Cr	%Ni	%Mo	%Mn
Requirements AWS ER309L	0.03 max	23.0 - 25.0	12.0 - 14.0	0.75 max	1.0 - 2.5
Typical Results⁽²⁾	0.01	23.4	13.6	0.06	1.6
	%Si	%P	%S	%Cu	FN
Requirements AWS ER309L	0.30 - 0.65	0.03 max	0.03 max	0.75 max	Not Required
Typical Results⁽²⁾	0.38	0.02	0.007	0.07	9 - 14

IMPORTANT: SPECIAL VENTILATION AND/OR EXHAUST REQUIRED

Fumes from the normal use of some welding products can contain significant quantities of components - such as chromium and manganese - which can lower the 5.0 mg/m³ maximum exposure guideline for general welding fume. BEFORE USE, READ AND UNDERSTAND THE SAFETY DATA SHEET (SDS) FOR THIS PRODUCT AND SPECIFIC INFORMATION PRINTED ON THE PRODUCT CONTAINER.

TYPICAL OPERATING PROCEDURES

Diameter, Polarity Shielding Gas	CTWD ⁽⁶⁾ mm (in)	Wire Feed Speed m/min (in/min)	Voltage (Volts)	Approx. Current (Amps)	Deposition Rate kg/hr (lb/hr)	
<i>Short Circuit Transfer</i>						
0.035 in (0.9 mm), DC+ 90% He / 7-1/2% Ar / 2-1/2% CO ₂	13 (1/2)	3.0 (120)	19-20	55	0.9 (2.0)	
	13 (1/2)	4.6 (180)	19-20	85	1.4 (3.0)	
	13 (1/2)	5.8 (230)	20-21	105	1.8 (3.9)	
	13 (1/2)	7.6 (300)	20-21	125	2.3 (5.0)	
	13 (1/2)	8.9 (350)	21-22	140	2.7 (5.9)	
	13 (1/2)	10.2 (400)	22-23	160	3.1 (6.7)	
0.045 in (1.1 mm), DC+ 90% He / 7-1/2% Ar / 2-1/2% CO ₂	13 (1/2)	2.5 (100)	19-20	100	1.1 (2.8)	
	13 (1/2)	3.2 (125)	19-20	120	1.5 (3.5)	
	13 (1/2)	3.8 (150)	21	135	1.7 (4.2)	
	13 (1/2)	4.4 (175)	21	140	2.0 (4.8)	
	13 (1/2)	5.6 (220)	22	170	2.6 (6.1)	
	13 (1/2)	6.4 (250)	22-23	175	2.9 (6.9)	
0.035 in (0.9 mm), DC+ 98% Ar/2% O ₂	13 (1/2)	10.2 (400)	22	180	3.1 (6.7)	
	13 (1/2)	10.8 (425)	23	190	3.3 (7.1)	
	13 (1/2)	11.4 (450)	23	200	3.5 (7.5)	
	13 (1/2)	12.1 (475)	23	210	3.7 (8.0)	
	0.045 in (1.1 mm), DC+ 98% Ar/2% O ₂	13 (1/2)	6.1 (240)	23	195	2.8 (6.6)
		13 (1/2)	6.6 (260)	24	230	3.0 (7.2)
13 (1/2)		7.6 (300)	24	240	3.5 (8.3)	
13 (1/2)		8.3 (325)	25	250	3.8 (9.0)	
13 (1/2)		9.1 (360)	25	260	4.2 (10.0)	
1/16 in (1.6 mm), DC+ 98% Ar/2% O ₂	19 (3/4)	4.4 (175)	25	260	4.3 (9.2)	
	19 (3/4)	5.1 (200)	26	310	4.9 (10.5)	
	19 (3/4)	6.4 (250)	26	330	6.2 (13.1)	
	19 (3/4)	7.0 (275)	27	360	6.8 (14.4)	
	19 (3/4)	7.6 (300)	28	390	7.4 (15.8)	

⁽¹⁾Typical all weld metal. ⁽²⁾Measured with 0.2% offset. ⁽³⁾See test results disclaimer ⁽⁴⁾AWS Requirements for ER308Si is 0.08% max carbon. ⁽⁵⁾Included in 0.50% max. for other elements not specified.

⁽⁶⁾To estimate ESO, subtract 1/8 in (3 mm) from CTWD.

BLUE MAX[®] MIG 309LMo_MOD

Stainless

KEY FEATURES

- Similar to 309L with the exception for the addition of 2.0 - 3.0% molybdenum to increase its pitting corrosion resistance in halide-containing environments
- Surfacing of base metals to improve their resistance to corrosion
- Used to achieve a single-layer overlay with a chemical composition similar to that of a 316L stainless steel

WELDING POSITIONS

All

CONFORMANCES

ISO 14343-A: 23 12 2 L

TYPICAL APPLICATIONS

- Used for the first layer of multilayer overlays with filler metals such as 316L or 317L stainless steel

SHIELDING GAS

98% Ar / 2% O₂

DIAMETERS / PACKAGING

Diameter in (mm)	33 lb (15 kg) Steel Spool
0.035 (0.9)	ED035082
0.045 (1.1)	ED035083
1/16 (1.6)	ED035084

WIRE COMPOSITION⁽¹⁾

	%C	%Cr	%Ni	%Mo	%Mn
Requirements AWS ER309LMo	0.03 max	21.0 - 21.8	14.2 - 15.3	2.0 - 3.0	1.0 - 2.5
Typical Results⁽²⁾	0.01	22.3	15.0	2.6	1.40
	%Si	%P	%S	%Cu	FN
Requirements AWS ER309LMo	0.30 - 0.65	0.03 max	0.03 max	0.75 max	Not Required
Typical Results⁽²⁾	0.40	0.02	0.01	0.10	6 - 12

TYPICAL OPERATING PROCEDURES

Diameter in (mm)	Voltage (volts)	Amperage	Gas Flow	Gas
0.035 (0.9)	26-29	160-210	30-50 CFH	98% Ar / 2% O ₂
0.045 (1.1)	28-32	180-250	30-50 CFH	
0.062 (1.6)	29-33	200-280	30-50 CFH	

⁽¹⁾ Typical wire composition. ⁽²⁾ See test results disclaimer

IMPORTANT: SPECIAL VENTILATION AND/OR EXHAUST REQUIRED

Fumes from the normal use of some welding products can contain significant quantities of components - such as chromium and manganese - which can lower the 5.0 mg/m³ maximum exposure guideline for general welding fume. BEFORE USE, READ AND UNDERSTAND THE SAFETY DATA SHEET (SDS) FOR THIS PRODUCT AND SPECIFIC INFORMATION PRINTED ON THE PRODUCT CONTAINER.

BLUE MAX[®] MIG 310

Stainless · AWS ER310

KEY FEATURES

- Austenitic stainless for high temperature, heat resistant applications
- The weld deposit is fully austenitic, low heat input welding procedures are needed to prevent cracking
- Q2 Lot[®] - Certificate showing actual wire composition

WELDING POSITIONS

All

SHIELDING GAS

98% Ar / 2% O₂

CONFORMANCES

AWS A5.9:	ER310
ASME SFA-5.9:	ER310
CWB/CSA:	ER310
ABS:	ER310

TYPICAL APPLICATIONS

- Heat shields
- Furnace parts
- Ducting
- Welding 310 Stainless and similar materials
- Used for welding stainless steels of similar composition in cast and wrought forms

DIAMETERS / PACKAGING

Diameter in (mm)	33 lb (15 kg) Steel Spool
0.035 (0.9)	ED035085
0.045 (1.1)	ED035086
1/16 (1.6)	ED035087

WIRE COMPOSITION⁽¹⁾ – As Required per AWS A5.9

	%C	%Cr	%Ni	%Mo	%Mn	%Si	%P	%S	%Cu
Requirements AWS ER310	0.08 - 0.15	25.0 - 28.0	20.0 - 22.5	0.75 max	1.0 - 2.5	0.30 - 0.65	0.03 max	0.03 max	0.75 max
Typical Results⁽²⁾	0.11	27.1	21.0		1.90	0.40	0.01	0.003	0.04

TYPICAL OPERATING PROCEDURES

Diameter in (mm)	Voltage (volts)	Amperage	Gas Flow	Gas
0.035 (0.9)	26-29	160-210	30-50 CFH	98% Ar / 2% O ₂
0.045 (1.1)	28-32	180-250		
1/16 (1.6)	29-33	200-280		

⁽¹⁾Typical wire composition. ⁽²⁾See test results disclaimer

IMPORTANT: SPECIAL VENTILATION AND/OR EXHAUST REQUIRED

Fumes from the normal use of some welding products can contain significant quantities of components - such as chromium and manganese - which can lower the 5.0 mg/m³ maximum exposure guideline for general welding fume. BEFORE USE, READ AND UNDERSTAND THE SAFETY DATA SHEET (SDS) FOR THIS PRODUCT AND SPECIFIC INFORMATION PRINTED ON THE PRODUCT CONTAINER.

BLUE MAX[®] MIG 312

Stainless · AWS ER312

KEY FEATURES

- The weld deposits exhibit high tensile strength and offer some resistance to abrasion
- Applications should be limited to 800°F (420°C)
- Q2 Lot[®] - Certificate showing actual wire composition and calculated ferrite number (FN) available online

WELDING POSITIONS

All

CONFORMANCES

AWS A5.9: ER312

ASME SFA-5.9: ER312

CWB/CSA: ER312

TYPICAL APPLICATIONS

- Tool steels
- Hard to weld steels
- Cast and wrought alloys
- Dissimilar metals

SHIELDING GAS

98% Argon / 2% Oxygen

DIAMETERS / PACKAGING

Diameter in (mm)	33 lb (15 kg) Steel Spool
0.045 (1.1)	ED035088
1/16 (1.6)	ED035089

WIRE COMPOSITION⁽¹⁾ – As Required per AWS A5.9

	%C	%Cr	%Ni	%Mo	%Mn
Requirements AWS ER312	0.15 max	28.0 - 32.0	8.0 - 10.5	0.75 max	1.0 - 2.5
Typical Results⁽²⁾	0.11	29.6	8.9		1.6
	%Si	%P	%S	%Cu	FN
Requirements AWS ER312	0.30 - 0.65	0.03 max	0.03 max	0.75 max	Not Required
Typical Results⁽²⁾	0.44	0.02	0.01	0.10	50 - 80

TYPICAL OPERATING PROCEDURES

Diameter in (mm)	Voltage (volts)	Amperage	Gas Flow	Gas
0.045 (1.1)	28-32	180-250	30-50 CFH	98% Ar / 2% O ₂
1/16 (1.6)	29-33	200-280		

⁽¹⁾Typical wire composition. ⁽²⁾See test results disclaimer

IMPORTANT: SPECIAL VENTILATION AND/OR EXHAUST REQUIRED

Fumes from the normal use of some welding products can contain significant quantities of components - such as chromium and manganese - which can lower the 5.0 mg/m³ maximum exposure guideline for general welding fume. BEFORE USE, READ AND UNDERSTAND THE SAFETY DATA SHEET (SDS) FOR THIS PRODUCT AND SPECIFIC INFORMATION PRINTED ON THE PRODUCT CONTAINER.

BLUE MAX® MIG 316L

Stainless · AWS ER316L

KEY FEATURES

- The 2-3% molybdenum improves pitting corrosion resistance of the weld deposit
- Low carbon content reduces the possibility of carbide precipitation and intergranular corrosion
- Q2 Lot® - Certificate showing actual wire composition and calculated ferrite number (FN) available online

WELDING POSITIONS

All

CONFORMANCES

AWS A5.9:	ER316, ER316L
CWB/CSA:	ER316, ER316L
ABS:	ER316, ER316L

TYPICAL APPLICATIONS

- Power Generation
- Chemical and Petrochemical Processing
- Designed for joining 316/316L stainless steels

SHIELDING GAS

98% Ar / 2% O₂

DIAMETERS / PACKAGING

Diameter in (mm)	33 lb (15 kg) Steel Spool	250 lb (113 kg) Accu-Trak® Drum
0.030 (0.8)	ED035091	
0.035 (0.9)	ED035092	ED035097
0.045 (1.1)	ED035098	ED035102
1/16 (1.6)	ED035104	

WIRE COMPOSITION⁽¹⁾ – As Required per AWS A5.9/A5.9M:

	%C	%Cr	%Ni	%Mo	%Mn
Requirements AWS ER316L	0.03 max	18.0 - 20.0	11.0 - 14.0	2.0 - 3.0	1.0 - 2.5
Typical Results⁽²⁾	0.01	18.5	12.1	2.4	1.6
	%Si	%P	%S	%Cu	FN
Requirements AWS ER316L	0.30 - 0.65	0.03 max	0.03 max	0.75 max	Not Required
Typical Results⁽²⁾	0.36	0.02	0.01	0.09	6 - 12

TYPICAL OPERATING PROCEDURES

Diameter in (mm)	Voltage [volts]	Amperage	Gas
0.030 (0.8)	26-29	160-210	98% Ar / 2% O ₂
0.035 (0.9)	26-29	160-210	
0.045 (1.1)	28-32	180-250	
1/16 (1.6)	29-33	200-280	

⁽¹⁾Typical wire composition ⁽²⁾See test results disclaimer

IMPORTANT: SPECIAL VENTILATION AND/OR EXHAUST REQUIRED

Fumes from the normal use of some welding products can contain significant quantities of components - such as chromium and manganese - which can lower the 5.0 mg/m³ maximum exposure guideline for general welding fume. BEFORE USE, READ AND UNDERSTAND THE SAFETY DATA SHEET (SDS) FOR THIS PRODUCT AND SPECIFIC INFORMATION PRINTED ON THE PRODUCT CONTAINER.

BLUE MAX[®] MIG 316LCF

Stainless · AWS ER316L

KEY FEATURES

- Controlled Low Ferrite (Range 3-5)
- Charpy V-Notch test results capable of exceeding 27 J (20 ft-lbf) @ -196°C (-320°F)
- Exceeds 15 mils (0.38 mm) of lateral expansion @ -196°C (-320°F)
- Q2 Lot[®] - Certificates showing actual wire composition available online

WELDING POSITIONS

All

CONFORMANCES

AWS A5.9: ER316, ER316L

ASME SFA-5.9: ER316, ER316L

TYPICAL APPLICATIONS

- LNG Storage
- Cryogenic Vessels and Piping

TYPICAL BASE METALS

- 316L stainless steel

SHIELDING GAS

98% Ar / 2% O₂

DIAMETERS / PACKAGING

Diameter in (mm)	33 lb (15 kg) Steel Spool
0.035 (0.9)	ED034925
0.045 (1.1)	ED034926
1/16 (1.6)	ED037178

WIRE COMPOSITION⁽¹⁾ – As Required per AWS A5.9

	%C	%Cr	%Ni	%Mo	%Mn
Requirements - AWS ER316L	0.03 max	18.0 - 20.0	11.0 - 14.0	2.0 - 3.0	1.0 - 2.5
Typical Results ⁽²⁾	0.01	18.5	12.1	2.4	1.6
	%Si	%P	%S	%Cu	FN
Requirements - AWS ER316L	0.30 - 0.65	0.03 max	0.03 max	0.75 max	Not Required
Typical Results ⁽²⁾	0.36	0.02	0.01	0.09	3 - 5

MECHANICAL PROPERTIES⁽¹⁾

	Yield Strength ⁽²⁾ MPa (ksi)	Tensile Strength MPa (ksi)	Elongation %	Charpy V-Notch J (ft-lbf) -196°C (-320°F)	Lateral Expansion mils (mm) -196°C (-320°F)
Typical Results ⁽²⁾ As-Welded with 98% Ar/2% O ₂	410 (69)	580 (85)	36	42 (56)	27 (0.69)

⁽¹⁾Typical wire composition. ⁽²⁾Measured with 0.2% offset ⁽³⁾See test results disclaimer

IMPORTANT: SPECIAL VENTILATION AND/OR EXHAUST REQUIRED

Fumes from the normal use of some welding products can contain significant quantities of components - such as chromium and manganese - which can lower the 5.0 mg/m³ maximum exposure guideline for general welding fume. BEFORE USE, READ AND UNDERSTAND THE SAFETY DATA SHEET (SDS) FOR THIS PRODUCT AND SPECIFIC INFORMATION PRINTED ON THE PRODUCT CONTAINER.

BLUE MAX[®] MIG 316LSi

Stainless · AWS ER316Si, ER316LSi

KEY FEATURES

- High silicon level for increased puddle fluidity and toe wetting
- Proprietary surface lubricant for steady feeding and arc stability
- Molybdenum grade for increased corrosion resistance
- Controlled ferrite content for maximum corrosion resistance
- Similar to 316L, with higher silicon content for optimum ease and speed in MIG welding and smooth bead appearance
- Q2 Lot[®] - Certificate showing actual wire composition and calculated ferrite number (FN) available online

WELDING POSITIONS

All

CONFORMANCES

AWS A5.9:	ER316Si, ER316LSi
ASME SFA-A5.9	ER316Si, ER316LSi
CWB/CSA W48-06:	ER316LSi
ISO 14343-B:	SS316LSi
ABS:	ER316Si, ER316LSi

TYPICAL APPLICATIONS

- Molybdenum bearing austenitic stainless steels
- Type 316 and 316L
- Performs exceptionally at high wire feed speeds

SHIELDING GAS

Short Circuiting Transfer:

90% He / 7.5% Argon / 2.5% CO₂

Axial Spray Transfer:

98% Argon / Balance Oxygen

DIAMETERS / PACKAGING

Diameter in (mm)	25 lb (11.3 kg) Plastic Spool	33 lb (15 kg) Plastic Spool	250 lb (113 kg) Accu-Trak [®] Drum	500 lb (227 kg) Accu-Trak [®] Drum
0.030 (0.8)	ED023963			
0.035 (0.9)		ED037302		ED029772
0.045 (1.1)		ED037303		ED029773
1/16 (1.6)	ED019300		ED035112	

MECHANICAL PROPERTIES⁽¹⁾ – As Required per AWS A5.9

	Yield Strength ⁽²⁾ MPa (ksi)	Tensile Strength MPa (ksi)	Elongation %	Ferrite Number
Typical Results ⁽³⁾ - As-Welded	405 (59)	560 (81)	40	7

⁽¹⁾Typical wire composition ⁽²⁾Measured with 0.2% offset ⁽³⁾See test results disclaimer

WIRE COMPOSITION⁽¹⁾ – As Required per AWS A5.9

	%C ⁽⁴⁾	%Cr	%Ni	%Mo	%Mn
Requirements - AWS ER316LSi	0.03 max	18.0-20.0	11.0-14.0	2.0-3.0	1.0-2.5
Typical Results⁽³⁾	0.02	18.9	11.8	2.2	2.1
	%Si	%P	%S	%N ⁽⁵⁾	%Cu
Requirements - AWS ER316LSi	0.65-1.00	0.03 max	0.03 max	Not Specified	0.75 max
Typical Results⁽³⁾	0.81	0.02	0.01	0.05	0.23

TYPICAL OPERATING PROCEDURES

Diameter, Polarity Shielding Gas	CTWD ⁽⁶⁾ mm (in)	Wire Feed Speed m/min (in/min)	Voltage (Volts)	Approx. Current (Amps)	Deposition Rate kg/hr (lb/hr)
-------------------------------------	--------------------------------	-----------------------------------	--------------------	---------------------------	----------------------------------

Short Circuit Transfer

0.035 in (0.9 mm), DC+ 90% He / 7-1/2% Ar / 2-1/2% CO ₂	13 (1/2)	3.0 (120)	19-20	55	0.9 (2.0)
	13 (1/2)	4.6 (180)	19-20	85	1.4 (3.0)
	13 (1/2)	5.8 (230)	20-21	105	1.8 (3.9)
	13 (1/2)	7.6 (300)	20-21	125	2.3 (5.0)
	13 (1/2)	8.9 (350)	21-22	140	2.7 (5.9)
	13 (1/2)	10.2 (400)	22-23	160	3.1 (6.7)
0.045 in (1.1 mm), DC+ 90% He / 7-1/2% Ar / 2-1/2% CO ₂	13 (1/2)	2.5 (100)	19-20	100	1.1 (2.8)
	13 (1/2)	3.2 (125)	19-20	120	1.5 (3.5)
	13 (1/2)	3.8 (150)	21	135	1.7 (4.2)
	13 (1/2)	4.4 (175)	21	140	2.0 (4.8)
	13 (1/2)	5.6 (220)	22	170	2.6 (6.1)
	13 (1/2)	6.4 (250)	22-23	175	2.9 (6.9)
13 (1/2)	7.0 (275)	22-23	185	3.2 (7.6)	

Axial Spray Transfer

0.035 in (0.9 mm), DC+ 98% Ar/2% O ₂	13 (1/2)	10.2 (400)	22	180	3.1 (6.7)
	13 (1/2)	10.8 (425)	23	190	3.3 (7.1)
	13 (1/2)	11.4 (450)	23	200	3.5 (7.5)
	13 (1/2)	12.1 (475)	23	210	3.7 (8.0)
0.045 in (1.1 mm), DC+ 98% Ar/2% O ₂	13 (1/2)	6.1 (240)	23	195	2.8 (6.6)
	13 (1/2)	6.6 (260)	24	230	3.0 (7.2)
	13 (1/2)	7.6 (300)	24	240	3.5 (8.3)
	13 (1/2)	8.3 (325)	25	250	3.8 (9.0)
	13 (1/2)	9.1 (360)	25	260	4.2 (10.0)
1/16 in (1.6 mm), DC+ 98% Ar/2% O ₂	19 (3/4)	4.4 (175)	25	260	4.3 (9.2)
	19 (3/4)	5.1 (200)	26	310	4.9 (10.5)
	19 (3/4)	6.4 (250)	26	330	6.2 (13.1)
	19 (3/4)	7.0 (275)	27	360	6.8 (14.4)
	19 (3/4)	7.6 (300)	28	390	7.4 (15.8)

⁽¹⁾Typical wire composition. ⁽²⁾Measured with 0.2% offset. ⁽³⁾See test results disclaimer. ⁽⁴⁾AWS Requirement for ER316Si is 0.12% max. carbon. ⁽⁵⁾Included in 0.50% max. for other elements not specified.

⁽⁶⁾To estimate ESO, subtract 1/8 in (3 mm) from CTWD.

IMPORTANT: SPECIAL VENTILATION AND/OR EXHAUST REQUIRED

Fumes from the normal use of some welding products can contain significant quantities of components - such as chromium and manganese - which can lower the 5.0 mg/m³ maximum exposure guideline for general welding fume. BEFORE USE, READ AND UNDERSTAND THE SAFETY DATA SHEET (SDS) FOR THIS PRODUCT AND SPECIFIC INFORMATION PRINTED ON THE PRODUCT CONTAINER.

BLUE MAX[®] MIG 317L

Stainless · AWS ER317L

KEY FEATURES

- Weld deposit similar to 316L with high molybdenum content for increased corrosion resistance
- Not suitable for structural service above 400°C (752°F) or for cryogenic applications

WELDING POSITIONS

All

SHIELDING GAS

98% Ar / 2% O₂

CONFORMANCES

AWS A5.9:	ER317, ER317L
ASME SFA-5.9:	ER317, ER317L
CWB/ CSA:	ER317, ER317L

TYPICAL APPLICATIONS

- Food Processing
- Chemical Processing Plants
- Condensers
- Petrochemical
- Paper Making
- Designed for welding 317L and alloys with similar composition in high corrosive environments

DIAMETERS / PACKAGING

Diameter in (mm)	33 lb (15 kg) Steel Spool
0.035 (0.9)	ED035116
0.045 (1.1)	ED035117
1/16 (1.6)	ED035119

WIRE COMPOSITION⁽¹⁾ – As Required per AWS A5.9

	%C	%Cr	%Ni	%Mo	%Mn
Requirements AWS ER317L	0.03 max.	18.5 - 20.5	13.0 - 15.0	3.0 - 4.0	1.0 - 2.5
Typical Results⁽²⁾	0.01	18.9	13.7	3.5	1.4
	%Si	%P	%S	%Cu	
Requirements AWS ER317L	0.30 - 0.65	0.03 max	0.03 max	0.75 max	
Typical Results⁽²⁾	0.45	0.01	0.008	0.08	

TYPICAL OPERATING PROCEDURES

Diameter in (mm)	Voltage (volts)	Amperage	Gas Flow	Gas
0.035 (0.9)	26-29	160-210	30-50 CFH	98% Ar / 2% O ₂
0.045 (1.1)	28-32	180-250		
1/16 (1.6)	29-33	200-280		

⁽¹⁾Typical wire composition. ⁽²⁾See test results disclaimer

IMPORTANT: SPECIAL VENTILATION AND/OR EXHAUST REQUIRED

Fumes from the normal use of some welding products can contain significant quantities of components - such as chromium and manganese - which can lower the 5.0 mg/m³ maximum exposure guideline for general welding fume. BEFORE USE, READ AND UNDERSTAND THE SAFETY DATA SHEET (SDS) FOR THIS PRODUCT AND SPECIFIC INFORMATION PRINTED ON THE PRODUCT CONTAINER.

BLUE MAX[®] MIG 320LR

Stainless · AWS ER320LR

KEY FEATURES

- LR contains low residual elements for better resistance to hot cracking
- Excellent corrosion resistance
- Q2 Lot[®] - Certificate showing actual wire composition

WELDING POSITIONS

All

SHIELDING GAS

98% Ar / 2% O₂

DIAMETERS / PACKAGING

Diameter in (mm)	33 lb (15 kg) Steel Spool
0.035 (0.9)	ED035122
0.045 (1.1)	ED035123
1/16 (1.6)	ED035124

CONFORMANCES

AWS A5.9:	ER320LR
ASME SFA-5.9:	ER320LR
CWB/ CSA:	ER 320LR

TYPICAL APPLICATIONS

- Process Piping
- Heat Exchangers
- Agitators and rotors
- Chemical processing
- Metal cleaning and pickling industries
- Typically used for welding Alloy 20 base materials and materials in similar composition

WIRE COMPOSITION⁽¹⁾ – As Required per AWS A5.9

	%C	%Cr	%Ni	%Mo	%Mn
Requirements AWS ER320LR	0.025 max	19.0 - 21.0	32.0 - 36.0	2.0 - 3.0	1.5 - 2.0
Typical Results⁽²⁾	0.003	20.1	33.3	2.4	1.7
	%Si	%P	%S	%Cu	%Nb
Requirements AWS ER320LR	0.15 max	0.015 max	0.02 max	3.0 - 4.0	Required 8 x C / 1.0 max
Typical Results⁽²⁾	0.01	0.010	0.001	3.3	0.22

TYPICAL OPERATING PROCEDURES

Diameter in (mm)	Voltage (volts)	Amperage	Gas Flow	Gas
0.035 (0.9)	26-29	160-210	30-50 CFH	98% Ar / 2% O ₂
0.045 (1.1)	28-32	180-250		
1/16 (1.6)	29-33	200-280		

⁽¹⁾Typical wire composition. ⁽²⁾See test results disclaimer.

IMPORTANT: SPECIAL VENTILATION AND/OR EXHAUST REQUIRED

Fumes from the normal use of some welding products can contain significant quantities of components - such as chromium and manganese - which can lower the 5.0 mg/m³ maximum exposure guideline for general welding fume. BEFORE USE, READ AND UNDERSTAND THE SAFETY DATA SHEET (SDS) FOR THIS PRODUCT AND SPECIFIC INFORMATION PRINTED ON THE PRODUCT CONTAINER.

BLUE MAX[®] MIG 330

Stainless · AWS ER330

KEY FEATURES

- High sulfur environments adversely affect the high temperature performance
- Heat input must be kept at a minimum during welding to avoid possible micro-fissuring
- Q2 Lot[®] - Certificate showing actual wire composition

WELDING POSITIONS

All

SHIELDING GAS

98% Ar / 2% O₂

DIAMETERS / PACKAGING

Diameter in (mm)	33 lb (15 kg) Steel Spool
0.035 (0.9)	ED035125
0.045 (1.1)	ED035127

CONFORMANCES

AWS A5.9:	ER330
ASME SFA-5.9:	ER330
CWB/CSA:	ER330

TYPICAL APPLICATIONS

- Heat Treatment
- Furnace Environments
- Used to weld wrought and cast forms of stainless steels of similar chemical compositions, which offer good heat and scale resistance to 1800°F (980°C)

WIRE COMPOSITION⁽¹⁾ – As Required per AWS A5.9

	%C	%Cr	%Ni	%Mo	%Mn
Requirements AWS ER330	0.18 - 0.25	15.0 - 17.0	34.0 - 37.0	0.75 max	1.0 - 2.5
Typical Results⁽²⁾	0.23	15.9	35.2		1.9
	%Si	%P	%S	%Cu	
Requirements AWS ER330	0.30 - 0.65	0.03	0.03	0.75 max	
Typical Results⁽²⁾	0.42	0.01	0.005	0.10	

TYPICAL OPERATING PROCEDURES

Diameter in (mm)	Voltage (volts)	Amperage	Gas Flow	Gas
0.035 (0.9)	26-29	160-210	30-50 CFH	98% Ar / 2% O ₂
0.045 (1.1)	28-32	180-250		

⁽¹⁾Typical wire composition. ⁽²⁾See test results disclaimer.

IMPORTANT: SPECIAL VENTILATION AND/OR EXHAUST REQUIRED

Fumes from the normal use of some welding products can contain significant quantities of components - such as chromium and manganese - which can lower the 5.0 mg/m³ maximum exposure guideline for general welding fume. BEFORE USE, READ AND UNDERSTAND THE SAFETY DATA SHEET (SDS) FOR THIS PRODUCT AND SPECIFIC INFORMATION PRINTED ON THE PRODUCT CONTAINER.

BLUE MAX[®] MIG 347

Stainless · AWS ER347

KEY FEATURES

- The addition of niobium reduces intergranular corrosion in severe operating conditions
- Q2 Lot[®] - Certificate showing actual chemistry available online

WELDING POSITIONS

All

SHIELDING GAS

98% Ar / 2% O₂

CONFORMANCES

AWS A5.9: ER347
CWB/CSA: ER347
ABS: ER347

TYPICAL APPLICATIONS

- High temperature stainless applications
- Pharmaceutical Equipment
- Welding 321 and 347 type stainless and stainless clad steels
- Food Processing

DIAMETERS / PACKAGING

Diameter in (mm)	33 lb (15 kg) Steel Spool	500 lb (227 kg) Speed Feed [®] Reel
0.035 (0.9)	ED035128	ED035133
0.045 (1.1)	ED035130	
1/16 (1.6)	ED035132	

WIRE COMPOSITION⁽¹⁾ – As Required per AWS A5.9

	%C	%Cr	%Ni	%Mo	%Nb + Ta
Requirements AWS ER347	0.08 max	19.0 - 21.5	9.0 - 11.0	0.75 max	10 x C - 1.0
Typical Results⁽²⁾	0.03	19.5	9.3	0.25	0.60
	%Mn	%Si	%P	%S	%Cu
Requirements AWS ER347	1.0 - 2.5	0.30 - 0.65	0.03 max	0.03 max	0.75 max
Typical Results⁽²⁾	1.7	0.45	0.01	0.007	0.10

TYPICAL OPERATING PROCEDURES

Diameter in (mm)	Voltage (volts)	Amperage	Gas Flow	Gas
0.035 (0.9)	26-29	160-210	30-50 CFH	98% Ar / 2% O ₂
0.045 (1.1)	28-32	180-250		
1/16 (1.6)	29-33	200-280		

⁽¹⁾Typical wire composition. ⁽²⁾See test results disclaimer

IMPORTANT: SPECIAL VENTILATION AND/OR EXHAUST REQUIRED

Fumes from the normal use of some welding products can contain significant quantities of components - such as chromium and manganese - which can lower the 5.0 mg/m³ maximum exposure guideline for general welding fume. BEFORE USE, READ AND UNDERSTAND THE SAFETY DATA SHEET (SDS) FOR THIS PRODUCT AND SPECIFIC INFORMATION PRINTED ON THE PRODUCT CONTAINER.

BLUE MAX[®] MIG 385

Stainless · AWS ER385

KEY FEATURES

- Super austenitic stainless steel provides resistance to stress corrosion cracking
- Low heat input procedures needed
- Q2 Lot[®] Certificate showing actual chemistry available online

WELDING POSITIONS

All

SHIELDING GAS

98% Ar / 2% O₂

CONFORMANCES

AWS A5.9: ER385

ASME SFA-5.9: ER385

CWB/CSA: ER385

TYPICAL APPLICATIONS

- Used for welding 904L stainless steel
- Used in fabrication of equipment and vessels for handling and storage of sulfuric acid, phosphoric acid, and other inorganic and organic acids
- Process piping

DIAMETERS / PACKAGING

Diameter in (mm)	33 lb (15 kg) Steel Spool
0.035 (0.9)	ED035134
0.045 (1.1)	ED035135
1/16 (1.6)	ED035136

WIRE COMPOSITION⁽¹⁾ – As Required per AWS A5.9

	%C	%Cr	%Ni	%Mo	%Mn
Requirements AWS ER385	0.025 max	19.5 - 21.5	24.0 - 26.0	4.2 - 5.2	1.0 - 2.5
Typical Results⁽²⁾	0.010	19.9	25.0	4.2	1.8
	%Si	%P	%S	%Cu	
Requirements AWS ER385	0.50 max	0.02 max	0.03 max	1.2 - 2.0	
Typical Results⁽²⁾	0.3	0.01	0.001	1.4	

TYPICAL OPERATING PROCEDURES

Diameter in (mm)	Voltage (volts)	Amperage	Gas Flow	Gas
0.035 (0.9)	26-29	160-210	30-50 CFH	98% Ar / 2% O ₂
0.045 (1.1)	28-32	180-250		
1/16 (1.6)	29-33	200-280		

⁽¹⁾Typical wire composition. ⁽²⁾See test results disclaimer

IMPORTANT: SPECIAL VENTILATION AND/OR EXHAUST REQUIRED

Fumes from the normal use of some welding products can contain significant quantities of components - such as chromium and manganese - which can lower the 5.0 mg/m³ maximum exposure guideline for general welding fume. BEFORE USE, READ AND UNDERSTAND THE SAFETY DATA SHEET (SDS) FOR THIS PRODUCT AND SPECIFIC INFORMATION PRINTED ON THE PRODUCT CONTAINER.

BLUE MAX[®] MIG 409Nb

Stainless · AWS ER409Nb

KEY FEATURES

- A ferritic stainless steel
- The addition of niobium improves corrosion resistance and promotes a ferritic micro-structure
- For the best results, welding must be done in a low heat input procedure not recommended for multi-pass applications
- Q2 Lot[®] - Certificate showing actual chemistry available online

WELDING POSITIONS

All

CONFORMANCES

AWS A5.9: ER409Nb

ASME SFA-5.9: ER409Nb

TYPICAL APPLICATIONS

- Automotive Exhausts
- Catalytic Converters under typical applications
- Designed to weld type 409 and 409Ti base materials

SHIELDING GAS

98% Ar / 2% O₂

DIAMETERS / PACKAGING

Diameter in (mm)	33 lb (15 kg) Steel Spool
0.035 (0.9)	ED035137
0.045 (1.1)	ED035138

WIRE COMPOSITION⁽¹⁾ – As Required per AWS A5.9

	%C	%Cr	%Ni	%Mo	%Nb
Requirements AWS ER409Nb	0.08 max	10.5 - 13.5	0.6 max	0.50 max	0.075 max
Typical Results⁽²⁾	0.04	11.5	0.4	0.03	0.50
	%Mn	%Si	%P	%S	%Cu
Requirements AWS ER409Nb	0.8 max	1.0 max	0.04 max	0.03 max	0.75 max
Typical Results⁽²⁾	0.62	0.48	0.02	0.02	0.04

TYPICAL OPERATING PROCEDURES

Diameter in (mm)	Voltage (volts)	Amperage	Gas Flow	Gas
0.035 (0.9)	26-29	160-210	30-50 CFH	98% Ar / 2% O ₂
0.045 (1.1)	28-32	180-250		

⁽¹⁾Typical wire composition. ⁽²⁾See test results disclaimer

IMPORTANT: SPECIAL VENTILATION AND/OR EXHAUST REQUIRED

Fumes from the normal use of some welding products can contain significant quantities of components - such as chromium and manganese - which can lower the 5.0 mg/m³ maximum exposure guideline for general welding fume. BEFORE USE, READ AND UNDERSTAND THE SAFETY DATA SHEET (SDS) FOR THIS PRODUCT AND SPECIFIC INFORMATION PRINTED ON THE PRODUCT CONTAINER.

BLUE MAX® MIG 410

Stainless · AWS ER410

KEY FEATURES

- Designed to weld stainless steels of similar chemical composition as well as to overlay carbon steels to impart corrosion, erosion and abrasion resistance
- Preheat and inter-pass temperature of 400°F (200°C) or greater are recommended during welding
- Q2 Lot® Certificate showing actual wire composition is recommended available online

WELDING POSITIONS

All

CONFORMANCES

AWS A5.9: ER410
CWB/CSA: ER410

TYPICAL APPLICATIONS

- Surfacing Steel Mill Rolls
- Furnace and Burner Parts
- Turbine Parts

SHIELDING GAS

98% Ar / 2% O₂

DIAMETERS / PACKAGING

Diameter in (mm)	33 lb (15 kg) Steel Spool	500 lb (227 kg) Speed Feed® Reel	750 lb (340 kg) Accu-Trak® Drum	1000 lb (454 kg) Speed Feed® Reel	1000 lb (454 kg) Accu-Trak® Drum
0.035 (0.9)	ED035139		ED037564		
0.045 (1.1)	ED035140	ED035141		ED035142	ED035398
1/16 (1.6)	ED035143				

WIRE COMPOSITION⁽¹⁾ – As Required per AWS A5.9

	%C	%Cr	%Ni	%Mo	%Mn
Requirements AWS ER410	0.12 max	11.5 - 13.5	0.6 max	0.75 max	0.6 max
Typical Results⁽²⁾	0.11	12.5	0.1	0.03	0.45
	%Si	%P	%S	%Cu	
Requirements AWS ER410	0.5 max	0.03 max	0.03 max	0.75 max	
Typical Results⁽²⁾	0.39	0.01	0.01	0.14	

TYPICAL OPERATING PROCEDURES

Diameter in (mm)	Voltage (volts)	Amperage	Gas Flow	Gas
0.035 (0.9)	26-29	160-210	30-50 CFH	98% Ar / 2% O ₂
0.045 (1.1)	28-32	180-250		

⁽¹⁾Typical wire composition. ⁽²⁾See test results disclaimer

IMPORTANT: SPECIAL VENTILATION AND/OR EXHAUST REQUIRED

Fumes from the normal use of some welding products can contain significant quantities of components - such as chromium and manganese - which can lower the 5.0 mg/m³ maximum exposure guideline for general welding fume. BEFORE USE, READ AND UNDERSTAND THE SAFETY DATA SHEET (SDS) FOR THIS PRODUCT AND SPECIFIC INFORMATION PRINTED ON THE PRODUCT CONTAINER.

BLUE MAX[®] MIG 410NiMo

Stainless · AWS ER410NiMo

KEY FEATURES

- Used to overlay mild and low alloy steels
- Preheat and inter-pass temperature of 300°F (150°C) or greater are recommended during welding
- Post-weld heat treatment should not exceed 1150°F (620°C) as higher temperatures may result in hardening
- Q2 Lot[®] - Certificate showing actual chemistry available online

WELDING POSITIONS

All

CONFORMANCES

AWS A5.9: ER410NiMo
ASME SFA5.9: ER410NiMo

TYPICAL APPLICATIONS

- Turbines
- Valve Bodies
- Power Generation
- Chemical & Petrochemical
- High Pressure Piping
- Designed to weld materials of similar chemical composition in cast and wrought forms

SHIELDING GAS

98% Ar / 2% O₂

DIAMETERS / PACKAGING

Diameter in (mm)	33 lb (15 kg) Steel Spool
0.035 (0.9)	ED035144
0.045 (1.1)	ED035145
1/16 (1.6)	ED036501

WIRE COMPOSITION⁽¹⁾ – As Required per AWS A5.9

	%C	%Cr	%Ni	%Mo	%Mn
Requirements AWS ER410NiMo	0.06 max	11.0 - 12.5	4.0 - 5.0	0.4 - 0.7	0.6 max
Typical Results⁽²⁾	0.02	11.7	4.7	0.5	0.2
	%Si	%P	%S	%Cu	
Requirements AWS ER410NiMo	0.5 max	0.03 max	0.03 max	0.75 max	
Typical Results⁽²⁾	0.2	0.01	0.002	0.06	

TYPICAL OPERATING PROCEDURES

Diameter in (mm)	Voltage (volts)	Amperage	Gas Flow	Gas
0.035 (0.9)	26-29	160-210	30-50 CFH	98% Ar / 2% O ₂
0.045 (1.1)	28-32	180-250		

⁽¹⁾Typical wire composition. ⁽²⁾See test results disclaimer

IMPORTANT: SPECIAL VENTILATION AND/OR EXHAUST REQUIRED

Fumes from the normal use of some welding products can contain significant quantities of components - such as chromium and manganese - which can lower the 5.0 mg/m³ maximum exposure guideline for general welding fume. BEFORE USE, READ AND UNDERSTAND THE SAFETY DATA SHEET (SDS) FOR THIS PRODUCT AND SPECIFIC INFORMATION PRINTED ON THE PRODUCT CONTAINER.

BLUE MAX[®] MIG 420

Stainless · AWS ER420

KEY FEATURES

- Higher hardness levels than Blue Max 410, due to higher carbon & Chromium content
- Intended to weld stainless steels similar in chemical composition
- Q2 Lot[®] - Certificate showing actual wire composition and calculated ferrite number (FN) available online

WELDING POSITIONS

All

SHIELDING GAS

98% Ar / 2% O₂

CONFORMANCES

AWS A5.9: ER420

ASME SFA-5.9: ER420

TYPICAL APPLICATIONS

- Hydraulic Equipment Components
- Impellers
- Pump Shafts

DIAMETERS / PACKAGING

Diameter in (mm)	25 lb (11 kg) Plastic Spool	33 lb (15 kg) Steel Spool
0.045 (1.1)	ED036661	ED035146
1/16 (1.6)		

WIRE COMPOSITION⁽¹⁾ – As Required per AWS A5.9

	%C	%Mn	%Si	%S	%P
Requirements AWS ER420	0.25-0.40	0.60	0.50	0.03	0.03
Typical Results⁽²⁾	0.32	0.30	0.30	0.01	0.02
	%Cr	%Ni	%Mo	%Cu	
Requirements AWS ER420	12.0-14.0	0.60	0.75	0.75	
Typical Results⁽²⁾	13.20	0.20	0.03	0.02	

TYPICAL OPERATING PROCEDURES

Diameter in (mm)	Voltage (volts)	Amperage	Gas Flow	Gas
1/16 (1.6)	29-33	200-280	30-50 CFH	98% Ar / 2% O ₂

⁽¹⁾Typical wire composition. ⁽²⁾See test results disclaimer

IMPORTANT: SPECIAL VENTILATION AND/OR EXHAUST REQUIRED

Fumes from the normal use of some welding products can contain significant quantities of components - such as chromium and manganese - which can lower the 5.0 mg/m³ maximum exposure guideline for general welding fume. BEFORE USE, READ AND UNDERSTAND THE SAFETY DATA SHEET (SDS) FOR THIS PRODUCT AND SPECIFIC INFORMATION PRINTED ON THE PRODUCT CONTAINER.

BLUE MAX[®] MIG 630

Stainless · AWS ER630

KEY FEATURES

- Heat treatment of material will obtain higher strength, and greatly influence mechanical properties
- Precipitation hardening, martensitic stainless steel
- Q2 Lot[®] Certificate showing actual wire composition and calculated ferrite number (FN) available online

WELDING POSITIONS

All

SHIELDING GAS

98% Ar / 2% O₂

CONFORMANCES

AWS A5.9:	ER630
ASME SFA-5.9:	ER630
CWB/CSA:	ER630

TYPICAL APPLICATIONS

- Hydraulic Equipment Components
- Impellers
- Pump Shafts
- Welding 17-4 PH stainless steels

DIAMETERS / PACKAGING

Diameter in (mm)	33 lb (15 kg) Steel Spool
0.035 (0.9)	ED035150
0.045 (1.1)	ED035151
1/16 (1.6)	ED035153

WIRE COMPOSITION⁽¹⁾ – As Required per AWS A5.9

	%C	%Cr	%Ni	%Mo	%Nb
Requirements AWS ER630	0.05 max	16.00 - 16.75	4.5 - 5.0	0.75 max	0.15 - 0.30
Typical Results⁽²⁾	0.03	16.5	4.8	0.2	0.22
	%Mn	%Si	%P	%S	%Cu
Requirements AWS ER630	0.25 - 0.75	0.75 max	0.03 max	0.03 max	3.25 - 4.0
Typical Results⁽²⁾	0.54	0.43	0.02	0.02	3.6

TYPICAL OPERATING PROCEDURES

Diameter in (mm)	Voltage (volts)	Amperage	Gas Flow	Gas
0.035 (0.9)	26-29	160-210	30-50 CFH	98% Argon / 2% CO ₂
0.045 (1.1)	28-32	180-250		

⁽¹⁾Typical wire composition. ⁽²⁾See test results disclaimer

IMPORTANT: SPECIAL VENTILATION AND/OR EXHAUST REQUIRED

Fumes from the normal use of some welding products can contain significant quantities of components - such as chromium and manganese - which can lower the 5.0 mg/m³ maximum exposure guideline for general welding fume. BEFORE USE, READ AND UNDERSTAND THE SAFETY DATA SHEET (SDS) FOR THIS PRODUCT AND SPECIFIC INFORMATION PRINTED ON THE PRODUCT CONTAINER.

BLUE MAX[®] MIG 2209

Stainless · AWS ER2209

KEY FEATURES

- The welds offer excellent resistance to stress corrosion, cracking and pitting
- The microstructure of the weld metal consists of austenite and ferrite
- Q2 Lot[®] Certificate showing actual wire composition and calculated ferrite number (FN) available online

WELDING POSITIONS

All

SHIELDING GAS

98% Ar / 2% O₂

CONFORMANCES

AWS A5.9:	ER2209
ASME SFA-5.9:	ER2209
CWB/CSA:	ER2209
ABS:	ER2209

TYPICAL APPLICATIONS

- Offshore
- Oil and Gas
- Chemical
- Petrochemical
- Welding 2205 duplex stainless steel

DIAMETERS / PACKAGING

Diameter in (mm)	33 lb (15 kg) Steel Spool
0.030 (0.8)	ED035023
0.035 (0.9)	ED035025
0.045 (1.1)	ED035027
1/16 (1.6)	ED035028

WIRE COMPOSITION⁽¹⁾ – As Required per AWS A5.9

	%C	%Cr	%Ni	%Mo	%Mn	%Si
Requirements AWS ER2209	0.03 max	21.5 - 23.5	7.5 - 9.5	2.5 - 3.5	0.5 - 2.0	0.90 max
Typical Results⁽²⁾	0.01	22.7	8.5	3.0	1.4	0.4
	%P	%S	%N	%Cu	FN	
Requirements AWS ER2209	0.03 max	0.03 max	0.08 - 0.20	0.75 max	Not Required	
Typical Results⁽²⁾	0.01	0.001	0.15	0.06	30 - 60	

TYPICAL OPERATING PROCEDURES

Diameter in (mm)	Voltage [volts]	Amperage	Gas Flow	Gas
0.035 (0.9)	26-29	160-210	30-50 CFH	98% Argon/ 2% Carbon Dioxide
0.045 (1.1)	28-32	180-250		
1/16 (1.6)	29-33	200-280		

⁽¹⁾Typical wire composition. ⁽²⁾See test results disclaimer

IMPORTANT: SPECIAL VENTILATION AND/OR EXHAUST REQUIRED

Fumes from the normal use of some welding products can contain significant quantities of components - such as chromium and manganese - which can lower the 5.0 mg/m³ maximum exposure guideline for general welding fume.
BEFORE USE, READ AND UNDERSTAND THE SAFETY DATA SHEET (SDS) FOR THIS PRODUCT AND SPECIFIC INFORMATION PRINTED ON THE PRODUCT CONTAINER.

BLUE MAX[®] MIG 2594

Stainless · AWS ER2594

KEY FEATURES

- A super-duplex grade electrode that provides matching chemistry and mechanical property characteristics to wrought super-duplex alloys such as 2507 and Zeron100, as well as to super-duplex casting alloys (ATSM A890)
- The electrode is over-alloyed 2-3% in nickel to provide the optimum ferrite/austenite ratio in the finished weld resulting in high tensile and yield strength and superior resistance to stress corrosion, cracking (SCC) and pitting corrosion
- Q2 Lot[®] - Certificate showing actual wire composition and calculated ferrite number (FN) available online

WELDING POSITIONS

All

CONFORMANCES

AWS A5.9:	ER2594
ASME SFA-5.9:	ER2594
CWB/CSA:	ER2594
ABS:	ER2594

TYPICAL APPLICATIONS

- Process Pipework
- Pumps and Valves
- Pressure Vessels
- Welding Zeron 100% and similar base metals

SHIELDING GAS

98% Ar / 2% O₂

DIAMETERS / PACKAGING

Diameter in (mm)	33 lb (15 kg) Steel Spool
0.035 (0.9)	ED035029
0.045 (1.1)	ED035030

WIRE COMPOSITION⁽¹⁾ – As Required per AWS A5.9

	%C	%Cr	%Ni	%Mo	%Mn	%Si
Requirements AWS ER2594	0.03 max	24.0 - 27.0	8.0 - 10.5	2.5 - 4.5	2.5 max	1.0 max
Typical Results⁽²⁾	0.02	24.6	8.6	3.8	0.8	0.3
	%P	%S	%N	%Cu	%W	FN
Requirements AWS ER2594	0.03 max	0.02 max	0.20 - 0.30	1.5 max	1.00 max	Not Required
Typical Results⁽²⁾	0.02	0.01	0.25	0.01	0.01	30 - 60

TYPICAL OPERATING PROCEDURES

Diameter in (mm)	Voltage (volts)	Amperage	Gas Flow	Gas
0.035 (0.9)	26-29	160-210	30-50 CFH	98% Ar / 2% O ₂
0.045 (1.1)	28-32	180-250		

⁽¹⁾Typical wire composition. ⁽²⁾See test results disclaimer

IMPORTANT: SPECIAL VENTILATION AND/OR EXHAUST REQUIRED

Fumes from the normal use of some welding products can contain significant quantities of components - such as chromium and manganese - which can lower the 5.0 mg/m³ maximum exposure guideline for general welding fume. BEFORE USE, READ AND UNDERSTAND THE SAFETY DATA SHEET (SDS) FOR THIS PRODUCT AND SPECIFIC INFORMATION PRINTED ON THE PRODUCT CONTAINER.

LINCOLN® RED MAX® 308LSI

Stainless · AWS ER308Si, ER308LSi

KEY FEATURES

- Engineered surface treatment for weldability control in semiautomatic applications
- High silicon level for increased puddle fluidity and toe wetting
- Q2 Lot® - Certificate showing actual wire composition and calculated ferrite number (FN) available online

WELDING POSITIONS

All

SHIELDING GAS

Short Circuiting Transfer:

90% He/ 75% Ar/ 2.5% CO₂

Axial Spray Transfer:

98% Argon/ Balance O₂ or CO₂

CONFORMANCES

AWS A5.9: ER308LSi, ER308Si

ASME SFA5.9: ER308LSi, ER308Si

ISO 14343-A: G 19 9 L Si

ISO 14343-B: SS308LSi, SS308Si

ABS: ER308LSi, ER308Si

TYPICAL APPLICATIONS

- Semiautomatic welding
- 304 and 304L stainless steel
- Common austenitic stainless steels referred to as "18-8" steels
- ASTM A743 or A744 Types CF-8 and CF-3

DIAMETERS / PACKAGING

Diameter in (mm)	10 lb (4.5kg) Steel Spool	33 lb (15 kg) PLW Steel Spool	500 lb (227 kg) Accu-Trak® Drum	500 lb (227 kg) Accu-Pak® Box
0.035 (0.9)	ED038003	ED037983	ED037989	ED037992
0.040 (1.0)		ED038001		
0.045 (1.1)	ED038004	ED037984	ED037990	ED037993
1/16 (1.6)		ED037985	ED037991	ED037994

MECHANICAL PROPERTIES⁽¹⁾ – As Required per AWS A5.9

	Yield Strength ⁽²⁾ MPa (ksi)	Tensile Strength MPa (ksi)	Elongation %	Ferrite Number
Requirements - AWS ER308Si, ER308LSi	Not Specified			
Typical Results⁽³⁾ - As-Welded	455 (66)	635 (92)	46	10

WIRE COMPOSITION⁽¹⁾ – As Required per AWS A5.9

	%C ⁽⁴⁾	%Cr	%Ni	%Mo	%Mn
Requirements - AWS ER308Si, ER308LSi	0.03 max	19.5-22.0	9.0-11.0	0.75 max	1.0-2.5
Typical Results⁽⁵⁾	0.01	19.9	10.0	0.16	2.1
	%Si	%P	%S	%N ⁽⁵⁾	%Cu
Requirements - AWS ER308Si, ER308LSi	0.65-1.00	0.03 max	0.03 max	Not Specified	0.75 max
Typical Results⁽⁵⁾	0.88	0.02	0.01	0.05	0.17

⁽¹⁾Typical all weld metal. ⁽²⁾Measured with 0.2% offset. ⁽³⁾See test results disclaimer. ⁽⁴⁾AWS Requirement for ER308Si is 0.08% max carbon. ⁽⁵⁾Included in 0.50% max. for other elements not specified.

TYPICAL OPERATING PROCEDURES

Diameter, Polarity Shielding Gas	CTWD ⁶¹ mm (in)	Wire Feed Speed m/min (in/min)	Voltage (Volts)	Approx. Current (Amps)	Deposition Rate kg/hr (lb/hr)
Short Circuit Transfer					
0.035 in (0.9 mm), DC+ 90% He / 75% Ar / 2.5% CO ₂	13 (1/2)	3.0 (120)	20-21	60	0.9 (2.0)
	13 (1/2)	4.6 (180)	21-23	90	1.4 (3.0)
	13 (1/2)	5.8 (230)	22-24	105	1.8 (3.9)
	13 (1/2)	7.6 (300)	23-25	130	2.3 (5.0)
	13 (1/2)	8.9 (350)	24-26	145	2.7 (5.9)
	13 (1/2)	10.2 (400)	25-27	155	3.1 (6.7)
0.045 in (1.1 mm), DC+ 90% He / 75% Ar / 2.5% CO ₂	13 (1/2)	2.5 (100)	20-21	80	1.1 (2.8)
	13 (1/2)	3.2 (125)	21-22	110	1.5 (3.5)
	13 (1/2)	3.8 (150)	21-23	130	1.7 (4.2)
	13 (1/2)	4.4 (175)	22-24	145	2.0 (4.8)
	13 (1/2)	5.6 (220)	23-25	170	2.6 (6.1)
	13 (1/2)	6.4 (250)	24-26	180	2.9 (6.9)
13 (1/2)	7.0 (275)	25-27	190	3.2 (7.6)	
Axial Spray Transfer					
0.035 in (0.9 mm), DC+ 98% Ar / 2% O ₂	13 (1/2)	10.2 (400)	23-24	190	3.1 (6.7)
	13 (1/2)	10.8 (425)	24-25	200	3.3 (7.1)
	13 (1/2)	11.4 (450)	24-25	210	3.5 (7.5)
	13 (1/2)	12.1 (475)	25-26	220	3.7 (8.0)
0.045 in (1.1 mm), DC+ 98% Ar / 2% O ₂	13 (1/2)	6.1 (240)	22-24	195	2.8 (6.6)
	13 (1/2)	6.6 (260)	23-25	215	3.0 (7.2)
	13 (1/2)	7.6 (300)	24-26	245	3.5 (8.3)
	13 (1/2)	8.3 (325)	25-27	250	3.8 (9.0)
	13 (1/2)	9.1 (360)	25-27	275	4.2 (10.0)

⁶¹Typical all weld metal. ⁶²Measured with 0.2% offset. ⁶³See test results disclaimer. ⁶⁴AWS Requirement for ER308Si is 0.08% max carbon. ⁶⁵Included in 0.50% max. for other elements not specified.

⁶⁶To estimate ESO, subtract 1/8 in (3.2 mm) from CTWD.

IMPORTANT: SPECIAL VENTILATION AND/OR EXHAUST REQUIRED

Fumes from the normal use of some welding products can contain significant quantities of components - such as chromium and manganese - which can lower the 5.0 mg/m³ maximum exposure guideline for general welding fume. BEFORE USE, READ AND UNDERSTAND THE SAFETY DATA SHEET (SDS) FOR THIS PRODUCT AND SPECIFIC INFORMATION PRINTED ON THE PRODUCT CONTAINER.

LINCOLN® RED MAX® 309LSI

Stainless · AWS ER309Si, ER309LSi

KEY FEATURES

- Engineered surface treatment for weldability control in semiautomatic applications
- High silicon level for increased puddle fluidity and toe wetting
- Q2 Lot® - Certificate showing actual wire composition and calculated ferrite number (FN) available online

WELDING POSITIONS

All

SHIELDING GAS

Short Circuiting Transfer:

90% He/ 75% Ar/ 2.5% CO₂

Axial Spray Transfer:

98% Argon/ Balance O₂ or CO₂

CONFORMANCES

AWS A5.9: ER309LSi, ER309Si

ASME SFA-5.9: ER309LSi, ER309Si

ISO 14343-A: G 23 12 L Si

ISO14343-B: SS309LSi, SS309Si

ABS: ER309LSi, ER309Si

TYPICAL APPLICATIONS

- Semiautomatic welding
- Designed for joining stainless steel to mild steel or low alloy steel

DIAMETERS / PACKAGING

Diameter in (mm)	10 lb (4.5kg) Steel Spool	33 lb (15 kg) PLW Steel Spool	500 lb (227 kg) Accu-Trak® Drum	500 lb (227 kg) Accu-Pak® Box
0.035 (0.9)	ED037347	ED036763	ED036971	ED036927
0.040 (1.0)		ED036992		
0.045 (1.1)	ED037348	ED036764	ED036972	ED036928
1/16 (1.6)	ED037349	ED036765	ED036973	ED036929

MECHANICAL PROPERTIES⁽¹⁾ – As Required per AWS A5.9

	Yield Strength ⁽²⁾ MPa (ksi)	Tensile Strength MPa (ksi)	Elongation %	Ferrite Number
Requirements - AWS ER309Si, ER309LSi	Not Specified			
Typical Results⁽³⁾ - As-Welded	450 (65)	595 (86)	42	11

WIRE COMPOSITION⁽¹⁾ – As Required per AWS A5.9

	%C ⁽⁴⁾	%Cr	%Ni	%Mo	%Mn
Requirements - AWS ER309Si, ER309LSi	0.03 max	23.0-25.0	12.0-14.0	0.75 max	1.0-2.5
Typical Results⁽³⁾ - As-Welded	0.03	23.5	13.7	0.28	2.0
	%Si	%P	%S	%N ⁽⁵⁾	%Cu
Requirements - AWS ER309Si, ER309LSi	0.65-1.00	0.03 max	0.03 max	Not Specified	0.75 max
Typical Results⁽³⁾ - As-Welded	0.89	0.02	0.01	0.06	0.22

⁽¹⁾Typical all weld metal. ⁽²⁾Measured with 0.2% offset. ⁽³⁾See test results disclaimer. ⁽⁴⁾AWS Requirement for ER309Si is 0.12% max carbon. ⁽⁵⁾Included in 0.50% max. for other elements not specified.

TYPICAL OPERATING PROCEDURES

Diameter, Polarity Shielding Gas	CTWD ⁽⁶⁾ mm (in)	Wire Feed Speed m/min (in/min)	Voltage (Volts)	Approx. Current (Amps)	Deposition Rate kg/hr (lb/hr)
Short Circuit Transfer					
0.035 in (0.9 mm), DC+ 90% He / 75% Ar / 2.5% CO ₂	13 (1/2)	3.0 (120)	20-21	60	0.9 (2.0)
	13 (1/2)	4.6 (180)	21-23	90	1.4 (3.0)
	13 (1/2)	5.8 (230)	22-24	105	1.8 (3.9)
	13 (1/2)	7.6 (300)	23-25	130	2.3 (5.0)
	13 (1/2)	8.9 (350)	24-26	145	2.7 (5.9)
	13 (1/2)	10.2 (400)	25-27	155	3.1 (6.7)
0.045 in (1.1 mm), DC+ 90% He / 75% Ar / 2.5% CO ₂	13 (1/2)	2.5 (100)	20-21	80	1.1 (2.8)
	13 (1/2)	3.2 (125)	21-22	110	1.5 (3.5)
	13 (1/2)	3.8 (150)	21-23	130	1.7 (4.2)
	13 (1/2)	4.4 (175)	22-24	145	2.0 (4.8)
	13 (1/2)	5.6 (220)	23-25	170	2.6 (6.1)
	13 (1/2)	6.4 (250)	24-26	180	2.9 (6.9)
13 (1/2)	7.0 (275)	25-27	190	3.2 (7.6)	
Axial Spray Transfer					
0.035 in (0.9 mm), DC+ 98% Ar / 2% O ₂	13 (1/2)	10.2 (400)	23-24	190	3.1 (6.7)
	13 (1/2)	10.8 (425)	24-25	200	3.3 (7.1)
	13 (1/2)	11.4 (450)	24-25	210	3.5 (7.5)
	13 (1/2)	12.1 (475)	25-26	220	3.7 (8.0)
0.045 in (1.1 mm), DC+ 98% Ar / 2% O ₂	13 (1/2)	6.1 (240)	22-24	195	2.8 (6.6)
	13 (1/2)	6.6 (260)	23-25	215	3.0 (7.2)
	13 (1/2)	7.6 (300)	24-26	245	3.5 (8.3)
	13 (1/2)	8.3 (325)	25-27	250	3.8 (9.0)
	13 (1/2)	9.1 (360)	25-27	275	4.2 (10.0)

⁽⁶⁾Typical all weld metal. ⁽²⁾Measured with 0.2% offset. ⁽³⁾See test results disclaimer. ⁽⁴⁾AWS Requirement for ER309Si is 0.12% max carbon. ⁽⁵⁾Included in 0.50% max. for other elements not specified.

⁽⁶⁾To estimate ESO, subtract 1/8 in (3.2 mm) from CTWD.

IMPORTANT: SPECIAL VENTILATION AND/OR EXHAUST REQUIRED

Fumes from the normal use of some welding products can contain significant quantities of components - such as chromium and manganese - which can lower the 5.0 mg/m³ maximum exposure guideline for general welding fume. BEFORE USE, READ AND UNDERSTAND THE SAFETY DATA SHEET (SDS) FOR THIS PRODUCT AND SPECIFIC INFORMATION PRINTED ON THE PRODUCT CONTAINER.

LINCOLN® RED MAX® 316LSi

Stainless · AWS ER316Si, ER316LSi

KEY FEATURES

- Engineered surface treatment for weldability control in semiautomatic applications
- High silicon level for increased puddle fluidity and toe wetting
- Molybdenum grade for increased corrosion resistance
- Q2 Lot* - Certificate showing actual wire composition and calculated ferrite number (FN) available online

WELDING POSITIONS

All

SHIELDING GAS

Short Circuiting Transfer:

90% He/ 75% Ar/ 2.5% CO₂

Axial Spray Transfer:

98% Argon/ Balance O₂ or CO₂

CONFORMANCES

AWS A5.9: ER316LSi, ER316Si

ASME SFA-5.9: ER316LSi, ER316Si

CWB/CSA: ER316LSi, ER316Si

ISO 14343-B: SS316LSi, SS316Si

ABS: ER316LSi, ER316Si

TYPICAL APPLICATIONS

- Semiautomatic welding
- Molybdenum bearing austenitic stainless steels
- 316 and 316L stainless steel

DIAMETERS / PACKAGING

Diameter in (mm)	10 lb (4.5kg) Steel Spool	33 lb (15 kg) PLW Steel Spool	500 lb (227 kg) Accu-Trak® Drum	500 lb (227 kg) Accu-Pak® Box
0.035 (0.9)	ED038005	ED037986	ED037998	ED037995
0.045 (1.1)		ED037987	ED037999	ED037996
1/16 (1.6)		ED037988	ED038000	ED037997

MECHANICAL PROPERTIES⁽¹⁾ – As Required per AWS A5.9

	Yield Strength ⁽²⁾ MPa (ksi)	Tensile Strength MPa (ksi)	Elongation %	Ferrite Number
Requirements - AWS ER316Si, ER316LSi	Not Specified			
Typical Results ⁽³⁾ - As-Welded	405 (59)	560 (81)	40	7

WIRE COMPOSITION⁽¹⁾ – As Required per AWS A5.9

	%C ⁽⁴⁾	%Cr	%Ni	%Mo	%Mn
Requirements - AWS ER316Si, ER316LSi	0.03 max	18.0-20.0	11.0-14.0	2.0-3.0	1.0-2.5
Typical Results ⁽³⁾	0.02	18.9	13.7	2.3	2.0
	%Si	%P	%S	%N ⁽⁵⁾	%Cu
Requirements - AWS ER316Si, ER316LSi	0.65-1.00	0.03 max	0.03 max	Not Specified	0.75 max
Typical Results ⁽³⁾	0.89	0.02	0.01	0.06	0.22

⁽¹⁾Typical all weld metal. ⁽²⁾Measured with 0.2% offset. ⁽³⁾See test results disclaimer. ⁽⁴⁾AWS Requirement for ER316Si is 0.08% max carbon. ⁽⁵⁾Included in 0.50% max. for other elements not specified.

TYPICAL OPERATING PROCEDURES

Diameter, Polarity Shielding Gas	CTWD ⁽⁶⁾ mm (in)	Wire Feed Speed m/min (in/min)	Voltage (Volts)	Approx. Current (Amps)	Deposition Rate kg/hr (lb/hr)
Short Circuit Transfer					
0.035 in (0.9 mm), DC+ 90% He / 75% Ar / 2.5% CO ₂	13 (1/2)	3.0 (120)	20-21	60	0.9 (2.0)
	13 (1/2)	4.6 (180)	21-23	90	1.4 (3.0)
	13 (1/2)	5.8 (230)	22-24	105	1.8 (3.9)
	13 (1/2)	7.6 (300)	23-25	130	2.3 (5.0)
	13 (1/2)	8.9 (350)	24-26	145	2.7 (5.9)
	13 (1/2)	10.2 (400)	25-27	155	3.1 (6.7)
0.045 in (1.1 mm), DC+ 90% He / 75% Ar / 2.5% CO ₂	13 (1/2)	2.5 (100)	20-21	80	1.1 (2.8)
	13 (1/2)	3.2 (125)	21-22	110	1.5 (3.5)
	13 (1/2)	3.8 (150)	21-23	130	1.7 (4.2)
	13 (1/2)	4.4 (175)	22-24	145	2.0 (4.8)
	13 (1/2)	5.6 (220)	23-25	170	2.6 (6.1)
	13 (1/2)	6.4 (250)	24-26	180	2.9 (6.9)
13 (1/2)	7.0 (275)	25-27	190	3.2 (7.6)	
Axial Spray Transfer					
0.035 in (0.9 mm), DC+ 98% Ar / 2% O ₂	13 (1/2)	10.2 (400)	23-24	190	3.1 (6.7)
	13 (1/2)	10.8 (425)	24-25	200	3.3 (7.1)
	13 (1/2)	11.4 (450)	24-25	210	3.5 (7.5)
	13 (1/2)	12.1 (475)	25-26	220	3.7 (8.0)
0.045 in (1.1 mm), DC+ 98% Ar / 2% O ₂	13 (1/2)	6.1 (240)	22-24	195	2.8 (6.6)
	13 (1/2)	6.6 (260)	23-25	215	3.0 (7.2)
	13 (1/2)	7.6 (300)	24-26	245	3.5 (8.3)
	13 (1/2)	8.3 (325)	25-27	250	3.8 (9.0)
	13 (1/2)	9.1 (360)	25-27	275	4.2 (10.0)

⁽¹⁾Typical all weld metal. ⁽²⁾Measured with 0.2% offset. ⁽³⁾See test results disclaimer. ⁽⁴⁾AWS Requirement for ER316Si is 0.08% max carbon. ⁽⁵⁾Included in 0.50% max. for other elements not specified. ⁽⁶⁾To estimate ESO, subtract 1/8 in (3.2 mm) from CTWD.

IMPORTANT: SPECIAL VENTILATION AND/OR EXHAUST REQUIRED

Fumes from the normal use of some welding products can contain significant quantities of components - such as chromium and manganese - which can lower the 5.0 mg/m³ maximum exposure guideline for general welding fume. BEFORE USE, READ AND UNDERSTAND THE SAFETY DATA SHEET (SDS) FOR THIS PRODUCT AND SPECIFIC INFORMATION PRINTED ON THE PRODUCT CONTAINER.

LINCOLN® RED MAX® 307_MOD

Stainless

KEY FEATURES

- Austenitic stainless steel
- 7% Manganese (Mn) increases resistance to hot cracking between dissimilar steels
- Q2 Lot* - Certificates showing actual wire composition and calculated ferrite number (FN) available online

WELDING POSITIONS

All

CONFORMANCES

ISO 14343-A: G 18 8 Mn

TYPICAL APPLICATIONS

- Automotive exhaust systems
- Armor Plate (military)
- Designed for joining dissimilar stainless steels
- Work hardening manganese steel

SHIELDING GAS

Short Circuiting Transfer

90% He / 7.5% Argon / 2.5% CO₂

Axial Spray Transfer

98% Argon / Balance O₂ or CO₂

DIAMETERS/PACKAGING

Diameter in (mm)	33 lb (15 kg) PLW Steel Spool	500 lb (227 kg) Accu-Trak® Drum	500 lb (227 kg) Accu-Pak® Box	750 lb (340 kg) Accu-Pak® Box
0.035 (0.9)	ED036933	ED036936	ED036937	ED037546
0.040 (1.0)	ED037173	ED037175	ED037174	
0.045 (1.1)	ED036934	ED036938	ED036939	
1/16 (1.6)	ED036935	ED036940	ED036941	

MECHANICAL PROPERTIES⁽¹⁾

	Yield Strength ⁽²⁾ MPa (ksi)	Tensile Strength MPa (ksi)	Elongation %
Typical Results ⁽²⁾ - As-Welded	434 (63)	627 (91)	38

WIRE COMPOSITION⁽¹⁾

	%C	%Mn	%Si	%Cr	%Ni	%S	%P
Typical Results ⁽²⁾	0.08	7.1	0.80	18.8	8.6	0.009	0.023

⁽¹⁾Typical wire composition. ⁽²⁾See test results disclaimer

TYPICAL OPERATING PROCEDURES

Diameter, Polarity Shielding Gas	CTWD ⁶¹ mm (in)	Wire Feed Speed m/min (in/min)	Voltage (Volts)	Approx. Current (Amps)	Deposition Rate kg/hr (lb/hr)
Short Circuit Transfer					
0.035 in (0.9 mm), DC+ 90% He / 7.5% Ar / 2.5% CO ₂	13 (1/2)	3.0 (120)	20-21	60	0.9 (2.0)
	13 (1/2)	4.6 (180)	21-23	90	1.4 (3.0)
	13 (1/2)	5.8 (230)	22-24	105	1.8 (3.9)
	13 (1/2)	7.6 (300)	23-25	130	2.3 (5.0)
	13 (1/2)	8.9 (350)	24-26	145	2.7 (5.9)
	13 (1/2)	10.2 (400)	25-27	155	3.1 (6.7)
0.045 in (1.1 mm), DC+ 90% He / 7.5% Ar / 2.5% CO ₂	13 (1/2)	2.5 (100)	20-21	80	1.1 (2.8)
	13 (1/2)	3.2 (125)	21-22	110	1.5 (3.5)
	13 (1/2)	3.8 (150)	21-23	130	1.7 (4.2)
	13 (1/2)	4.4 (175)	22-24	145	2.0 (4.8)
	13 (1/2)	5.6 (220)	23-25	170	2.6 (6.1)
	13 (1/2)	6.4 (250)	24-26	180	2.9 (6.9)
13 (1/2)	7.0 (275)	25-27	190	3.2 (7.6)	
Axial Spray Transfer					
0.035 in (0.9 mm), DC+ 98% Ar / 2% O ₂	13 (1/2)	10.2 (400)	23-24	190	3.1 (6.7)
	13 (1/2)	10.8 (425)	24-25	200	3.3 (7.1)
	13 (1/2)	11.4 (450)	24-25	210	3.5 (7.5)
	13 (1/2)	12.1 (475)	25-26	220	3.7 (8.0)
0.045 in (1.1 mm), DC+ 98% Ar / 2% O ₂	13 (1/2)	6.1 (240)	22-24	195	2.8 (6.6)
	13 (1/2)	6.6 (260)	23-25	215	3.0 (7.2)
	13 (1/2)	7.6 (300)	24-26	245	3.5 (8.3)
	13 (1/2)	8.3 (325)	25-27	250	3.8 (9.0)
	13 (1/2)	9.1 (360)	25-27	275	4.2 (10.0)

⁶¹Typical all weld metal. ⁶²Measured with 0.2% offset. ⁶³See test results disclaimer. ⁶⁴AWS Requirement for ER308Si is 0.08% max carbon. ⁶⁵Included in 0.50% max. for other elements not specified.

⁶⁶To estimate ESO, subtract 1/8 in (3.2 mm) from CTWD.

IMPORTANT: SPECIAL VENTILATION AND/OR EXHAUST REQUIRED

Fumes from the normal use of some welding products can contain significant quantities of components - such as chromium and manganese - which can lower the 5.0 mg/m³ maximum exposure guideline for general welding fume. BEFORE USE, READ AND UNDERSTAND THE SAFETY DATA SHEET (SDS) FOR THIS PRODUCT AND SPECIFIC INFORMATION PRINTED ON THE PRODUCT CONTAINER.

MUREX® 308LSI

Stainless · AWS ER308Si, ER308LSi

KEY FEATURES

- Similar in composition to 308L with higher silicon content to increase puddle fluidity and improve the bead appearance
- Used to primarily weld equipment made with 304 type stainless steel
- Q2 Lot® - Certificate showing actual wire composition and calculated ferrite number (FN) available online

WELDING POSITIONS

All

CONFORMANCES

AWS A5.9:	ER308Si, ER308LSi
ASME SFA-5.9:	ER308Si, ER308LSi
CWB/CSA:	ER308LSi

TYPICAL APPLICATIONS

- 304 and 304L stainless steels
- Common austenitic stainless steels referred to as "18-8" steels
- ASTM A743 or A744 Types CF-8 and CF-3

SHIELDING GAS

Short Circuiting Transfer:
90% He / 7.5% Ar / 2.5% CO₂

Axial Spray Transfer:
98% Argon / 2% Oxygen

DIAMETERS / PACKAGING

Diameter in (mm)	33 lb (14.9 kg) Steel Spool	500 lb (227 kg) Accu-Trak® Drum
0.030 (0.8)	ED036497	
0.035 (0.9)	ED035601	ED035604
0.040 (1.0)	ED037922	ED037923
0.045 (1.1)	ED035603	ED035605
0.47 (1.2)	ED036986	ED036987
1/16 (1.6)	ED035602	

WIRE COMPOSITION⁽¹⁾ – As Required per AWS A5.9

	%C ⁽⁴⁾	%Cr	%Ni	%Mo	%Mn
Requirements - AWS ER308LSi	0.03 max	19.5-22.0	9.0-11.0	0.75 max	1.0-2.5
Typical Results⁽³⁾	0.02	19.9	9.6	0.08	2.0
	%Si	%P	%S	%N ⁽⁵⁾	%Cu
Requirements - AWS ER308LSi	0.65-1.00	0.03 max	0.03 max	Not Specified	0.75 max
Typical Results⁽³⁾	0.81	0.02	0.02	0.05	0.06

⁽¹⁾Typical all weld metal. ⁽²⁾Measured with 0.2% offset. ⁽³⁾See test results disclaimer ⁽⁴⁾AWS Requirements for ER308Si is 0.08% max carbon. ⁽⁵⁾Included in 0.50% max. for other elements not specified.

IMPORTANT: SPECIAL VENTILATION AND/OR EXHAUST REQUIRED

Fumes from the normal use of some welding products can contain significant quantities of components - such as chromium and manganese - which can lower the 5.0 mg/m³ maximum exposure guideline for general welding fume. BEFORE USE, READ AND UNDERSTAND THE SAFETY DATA SHEET (SDS) FOR THIS PRODUCT AND SPECIFIC INFORMATION PRINTED ON THE PRODUCT CONTAINER.

MUREX[®] 309LSI

Stainless · AWS ER309Si, ER309LSi

KEY FEATURES

- Similar in composition to 309L with higher silicon content to increase puddle fluidity and improve the bead appearance
- Excellent contour of the weld minimizes the need for grinding
- Q2 Lot[®] - Certificate showing actual wire composition and calculated ferrite number (FN) available online

WELDING POSITIONS

All

CONFORMANCES

AWS A5.9:	ER309Si, ER309LSi
ASME SFA-5.9:	ER309Si, ER309LSi
CWB/CSA:	ER309LSi

TYPICAL APPLICATIONS

- Designed for joining stainless steel to mild or low alloy steel

SHIELDING GAS

Short Circuiting Transfer:
90% He/ 7.5% Ar/ 2.5% CO₂

Axial Spray Transfer:
98% Argon/ 2% Oxygen

DIAMETERS / PACKAGING

Diameter in (mm)	33 lb (14.9 kg) Steel Spool	500 lb (227 kg) Accu-Trak [®] Drum
0.030 (0.8)	ED035607	
0.035 (0.9)	ED035606	ED035609
0.045 (1.1)	ED035608	ED035610
1/16 (1.6)	ED036498	

WIRE COMPOSITION⁽¹⁾ – As Required per AWS A5.9

	%C ⁽⁴⁾	%Cr	%Ni	%Mo	%Mn
Requirements - AWS ER309LSi	0.03 max	23.0-25.0	12.0-14.0	0.75 max	1.0-2.5
Typical Results ⁽³⁾	0.02	23.4	13.7	0.30	2.1
	%Si	%P	%S	%N ⁽⁵⁾	%Cu
Requirements - AWS ER309LSi	0.65-1.00	0.03 max	0.03 max	Not Specified	0.75 max
Typical Results ⁽³⁾	0.77	0.02	<0.01	0.09	0.09

⁽¹⁾Typical wire composition. ⁽²⁾Measured with 0.2% offset ⁽³⁾See test results disclaimer ⁽⁴⁾AWS Requirement for ER309Si is 0.12% max. carbon. ⁽⁵⁾Included in 0.50% max. for other elements not specified.

IMPORTANT: SPECIAL VENTILATION AND/OR EXHAUST REQUIRED

Fumes from the normal use of some welding products can contain significant quantities of components - such as chromium and manganese - which can lower the 5.0 mg/m³ maximum exposure guideline for general welding fume. BEFORE USE, READ AND UNDERSTAND THE SAFETY DATA SHEET (SDS) FOR THIS PRODUCT AND SPECIFIC INFORMATION PRINTED ON THE PRODUCT CONTAINER.

MUREX[®] 316LSI

Stainless · AWS ER316Si, ER316LSi

KEY FEATURES

- Similar in composition to 316L with higher silicon content to increase puddle fluidity and improve the bead appearance
- Molybdenum grade for increased corrosion resistance
- Q2 Lot[®] - Certificate showing actual wire composition and calculated ferrite number (FN) available online

WELDING POSITIONS

All

CONFORMANCES

AWS A5.9:	ER316Si, ER316LSi
ASME SFA-5.9:	ER316Si, ER316LSi
CWB/CSA:	ER316LSi

TYPICAL APPLICATIONS

- Molybdenum bearing austenitic stainless steels
- Type 316 and 316L

SHIELDING GAS

Short Circuiting Transfer:

90% He / 75% Argon / 2.5% CO₂

Axial Spray Transfer:

98% Argon / 2% Oxygen

DIAMETERS / PACKAGING

Diameter in (mm)	33 lb (14.9 kg) Steel Spool	500 lb (227 kg) Accu-Trak [®] Drum
0.030 (0.8)	ED036499	
0.035 (0.9)	ED035611	ED035614
0.045 (1.1)	ED035613	ED035615
1/16 (1.6)	ED035612	

WIRE COMPOSITION⁽¹⁾ – As Required per AWS A5.9

	%C ⁽⁴⁾	%Cr	%Ni	%Mo	%Mn
Requirements - AWS ER316LSi	0.03 max	18.0-20.0	11.0-14.0	2.0-3.0	1.0-2.5
Typical Results ⁽³⁾	0.02	18.3	11.3	2.2	1.6
	%Si	%P	%S	%N ⁽⁵⁾	%Cu
Requirements - AWS ER316LSi	0.65-1.00	0.03 max	0.03 max	Not Specified	0.75 max
Typical Results ⁽³⁾	0.82	0.02	0.02	0.07	0.10

⁽¹⁾Typical wire composition. ⁽²⁾Measured with 0.2% offset. ⁽³⁾See test results disclaimer. ⁽⁴⁾AWS Requirement for ER316Si is 0.08% max. carbon. ⁽⁵⁾Included in 0.50% max. for other elements not specified.

IMPORTANT: SPECIAL VENTILATION AND/OR EXHAUST REQUIRED

Fumes from the normal use of some welding products can contain significant quantities of components - such as chromium and manganese - which can lower the 5.0 mg/m³ maximum exposure guideline for general welding fume. BEFORE USE, READ AND UNDERSTAND THE SAFETY DATA SHEET (SDS) FOR THIS PRODUCT AND SPECIFIC INFORMATION PRINTED ON THE PRODUCT CONTAINER.

ULTRACORE® 308L

Stainless | AWS E308T0-1, E308T0-4, E308LT0-1, E308LT0-4

KEY FEATURES

- Precision layer wound winding delivers steady spool payoff and more consistent feeding
- Smooth arc action with minimal spatter reduces post-weld cleaning
- Polished weld bead appearance reduces post-weld brushing

WELDING POSITIONS

Flat & Horizontal

SHIELDING GAS

75% Ar/25% CO₂ 100% CO₂

CONFORMANCES

- AWS A5.22:** E308LT0-1, E308LT0-4
ASME SFA-5.22: E308LT0-1, E308LT0-4
CWB/CSA: E308LT0-1, E308LT0-4

TYPICAL APPLICATIONS

- 304L and other common 18/8 stainless steels
- Nitrogen bearing 304LN and titanium stabilized 321
- General fabrication including piping, tanks, and pressure vessels

DIAMETERS / PACKAGING

Diameter mm (in)	10 lb (4.5 kg) PLW Plastic Spool (Vacuum Sealed Foil Bag)	33 lb (15 kg) PLW Plastic Spool (Vacuum Sealed Foil Bag)
1.1 (0.045)	ED037216	ED037118
1.6 1/16		ED037119

MECHANICAL PROPERTIES⁽¹⁾

	Yield Strength ⁽²⁾ MPa (ksi)	Tensile Strength MPa (ksi)	Elongation %	Ferrite Number
Requirements				
AWS E308LT0-1, E308LT0-4	Not Specified	520 (75) min	35 min	Not Specified
AWS E308T0-1, E308T0-4	Not Specified	550 (80) min		Not Specified
Typical Results⁽³⁾				
As-Welded with 100% CO ₂	386 (56)	566 (82)	40	7-11
As-Welded with 75% Ar/25% CO ₂	393 (57)	572 (83)	39	8-12

⁽¹⁾Typical all weld metal, DC+ ⁽²⁾Measured with 0.2% offset ⁽³⁾See test results disclaimer

DEPOSIT COMPOSITION⁽¹⁾

	%C ⁽⁴⁾	%Mn	%Si	%S	%P
Requirements AWS E308LT0-1 & E308LT0-4	0.04 max	0.5-2.5	1.0 max	0.03 max	0.04 max
Typical Results⁽³⁾ As-Welded with 100% CO ₂	≤0.03	1.2-1.3	0.6-0.7	≤ 0.01	≤ 0.02
As-Welded with 75% Ar/25% CO ₂	≤0.03	1.4-1.5	0.7-0.8	≤ 0.01	≤ 0.02
	%Ni	%Cr	%Mo	%Cu	%Bi
Requirements AWS E308LT0-1 & E308LT0-4	9.0-11.0	18.0-21.0	0.75 max	0.75 max	—
Typical Results⁽³⁾ As-Welded with 100% CO ₂	9.5-9.9	18.0-18.6	≤ 0.20	≤ 0.25	0.02
As-Welded with 75% Ar/25% CO ₂	9.7-9.9	18.5-19.0	≤ 0.20	≤ 0.25	0.02

⁽¹⁾Typical all weld metal, DC+ ⁽³⁾See test results disclaimer ⁽⁴⁾Requirement for E316T1-1 and E316T1-4 is 0.08% max. carbon

TYPICAL OPERATING PROCEDURES

Diameter, Polarity, Shielding Gas in (mm)	CTWD ⁽³⁾ mm (in)	Wire Feed Speed/ Voltage m/min (in/min)	Voltage (Volts)	Approx. Current (Amps)	Melt-Off Rate kg/hr (lb/hr)	Deposition Rate kg/hr (lb/hr)	Efficiency (%)
0.045 in (1.1 mm), DC+ 75% Ar/25% CO ₂	19 (3/4)	5.3 (210)	22-24	140	2.1 (4.6)	1.8 (4.0)	86
	19 (3/4)	8.9 (350)	24-26	185	3.6 (8.0)	3.1 (6.9)	86
	19 (3/4)	11.4 (450)	26-28	225	4.7 (10.4)	4.0 (8.8)	84
1/16 in (1.6 mm), DC+ 75% Ar/25% CO ₂	25 (1)	3.6 (140)	25-29	155	2.8 (6.2)	2.6 (5.2)	89.6
	25 (1)	6.4 (250)	27-31	250	5.0 (11.0)	4.2 (9.2)	89.3
	25 (1)	8.1 (320)	28-32	285	6.0 (13.2)	5.3 (11.7)	88.6

⁽³⁾To estimate ES0, subtract 1/4 in (6.0 mm) from CTWD. NOTE: Increase Voltage by 2V when using 100% CO₂.

IMPORTANT: SPECIAL VENTILATION AND/OR EXHAUST REQUIRED

Fumes from the normal use of some welding products can contain significant quantities of components - such as chromium and manganese - which can lower the 5.0 mg/m³ maximum exposure guideline for general welding fume. BEFORE USE, READ AND UNDERSTAND THE SAFETY DATA SHEET (SDS) FOR THIS PRODUCT AND SPECIFIC INFORMATION PRINTED ON THE PRODUCT CONTAINER.

ULTRACORE® 308L P

Stainless | AWS E308T1-1, E308T1-4, E308LT1-1, E308LT1-4

KEY FEATURES

- Precision layer wound winding delivers steady spool payoff and more consistent feeding
- Smooth arc action with minimal spatter reduces post-weld cleaning
- Polished weld bead appearance reduces post-weld brushing

WELDING POSITIONS

All Positions

SHIELDING GAS

75% Ar/25% CO₂ 100% CO₂

CONFORMANCES

- AWS A5.22:** E308LT1-1, E308LT1-4
ASME SFA-5.22: E308LT1-1, E308LT1-4
CWB/CSA: E308LT1-1, E308LT1-4

TYPICAL APPLICATIONS

- 304L and other common 18/8 stainless steels
- Nitrogen bearing 304LN and titanium stabilized 321
- General fabrication including piping, tanks and pressure vessels

DIAMETERS / PACKAGING

Diameter in (mm)	10 lb (4.5 kg) PLW Plastic Spool (Vacuum Sealed Foil Bag)	33 lb (15 kg) PLW Plastic Spool (Vacuum Sealed Foil Bag)	400 lb (181 kg) Drum
0.045 (1.1)	ED037217	ED037125	ED037660
1/16 (1.6)		ED037126	ED037661

MECHANICAL PROPERTIES⁽¹⁾

	Yield Strength ⁽²⁾ MPa (ksi)	Tensile Strength MPa (ksi)	Elongation %	Ferrite Number
Requirements				
AWS E308LT1-1, E308LT1-4	Not Specified	520 (75) min	35 min	Not Specified
AWS E308T1-1, E308T1-4	Not Specified	550 (80) min	35 min	Not Specified
Typical Results⁽³⁾				
As-Welded with 100% CO ₂	386 (56)	566 (82)	40	7-11
As-Welded with 75% Ar/25% CO ₂	393 (57)	572 (83)	39	8-12

⁽¹⁾Typical all weld metal, DC+ ⁽²⁾ Measured with 0.2% offset ⁽³⁾ See test results disclaimer

DEPOSIT COMPOSITION⁽¹⁾

	%C ⁽⁴⁾	%Mn	%Si	%S	%P
Requirements AWS E308LT1-1 & E308LT1-4	0.04 max	0.5-2.5	1.0 max	0.03 max	0.04 max
Typical Results⁽²⁾ As-Welded with 100% CO ₂	≤0.03	1.2-1.3	0.6-0.7	≤ 0.01	≤ 0.02
As-Welded with 75% Ar/25% CO ₂	≤0.03	1.4-1.5	0.7-0.8	≤ 0.01	≤ 0.02
	%Ni	%Cr	%Mo	%Cu	%Bi
Requirements AWS E308LT1-1 & E308LT1-4	9.0-11.0	18.0-21.0	0.75 max	0.75 max	—
Typical Results⁽²⁾ As-Welded with 100% CO ₂	9.5-9.9	18.0-18.6	≤ 0.20	≤ 0.25	0.01
As-Welded with 75% Ar/25% CO ₂	9.7-9.9	18.5-19.0	≤ 0.20	≤ 0.25	0.01

TYPICAL OPERATING PROCEDURES

Diameter, Polarity, Shielding Gas in (mm)	CTWD ⁽³⁾ mm (in)	Wire Feed Speed/ Voltage m/min (in/min)	Voltage (Volts)	Approx. Current (Amps)	Melt-Off Rate kg/hr (lb/hr)	Deposition Rate kg/hr (lb/hr)	Efficiency (%)
0.045 in (1.1 mm), DC+ 75% Ar/25% CO ₂	19 (3/4)	5.1 (200)	22-24	130	2.0 (4.3)	1.5 (3.3)	76.7
	19 (3/4)	8.4 (330)	24-26	180	3.3 (7.2)	2.6 (5.7)	79.1
	19 (3/4)	11.2 (440)	26-28	220	4.3 (9.5)	3.5 (7.8)	82.1
1/16 in (1.6 mm), DC+ 75% Ar/25% CO ₂	25 (1)	3.6 (140)	24-26	160	2.5 (5.6)	2.2 (4.8)	85.7
	25 (1)	5.0 (195)	24-26	200	3.5 (7.8)	3.0 (6.7)	85.8
	25 (1)	6.4 (250)	25-27	220	4.6 (10.1)	3.9 (8.6)	85.6

⁽³⁾To estimate ESQ, subtract 1/4 in (6.0 mm) from CTWD. NOTE: Increase Voltage by 2V when using 100% CO₂.

IMPORTANT: SPECIAL VENTILATION AND/OR EXHAUST REQUIRED

Fumes from the normal use of some welding products can contain significant quantities of components - such as chromium and manganese - which can lower the 5.0 mg/m³ maximum exposure guideline for general welding fume. BEFORE USE, READ AND UNDERSTAND THE SAFETY DATA SHEET (SDS) FOR THIS PRODUCT AND SPECIFIC INFORMATION PRINTED ON THE PRODUCT CONTAINER.

ULTRACORE® 309L

Stainless · AWS E309T0-1, E309T0-4, E309LT0-1, E309LT0-4

KEY FEATURES

- Precision layer wound winding delivers steady spool payoff and more consistent feeding
- Smooth arc action with minimal spatter reduces post-weld cleaning
- Polished weld bead appearance reduces post-weld brushing

WELDING POSITIONS

Flat & Horizontal

SHIELDING GAS

75% Ar/25% CO₂ 100% CO₂

CONFORMANCES

- AWS A5.22:** E309LT0-1, E309LT0-4
ASME SFA-5.22: E309LT0-1, E309LT0-4
CWB/CSA: E309LT0-1, E309LT0-4

TYPICAL APPLICATIONS

- Buffer layers and clad steels – overlays on CMn, mild steel or low alloy steels
- Dissimilar joints – stainless types 410, 304L, 321, and 316L to mild and low alloy steels

DIAMETERS / PACKAGING

Diameter in (mm)	10 lb [4.5 kg] PLW Plastic Spool (Vacuum Sealed Foil Bag)	33 lb [15 kg] PLW Plastic Spool (Vacuum Sealed Foil Bag)
0.045 (1.1)	ED037218	ED037120
1/16 (1.6)		ED037121

MECHANICAL PROPERTIES⁽¹⁾

	Yield Strength ⁽²⁾ MPa (ksi)	Tensile Strength MPa (ksi)	Elongation %	Ferrite Number
Requirements				
AWS E309LT0-1, E309LT0-4	Not Specified	520 (75) min	35 min	Not Specified
AWS E309T0-1, E309T0-4	Not Specified	550 (80) min	35 min	Not Specified
Typical Results⁽³⁾				
As-Welded with 100% CO ₂	434 (63)	565 (82)	33	—
As-Welded with 75% Ar/25% CO ₂	450 (65)	593 (86)	33	—

⁽¹⁾Typical all weld metal, DC+ ⁽²⁾ Measured with 0.2% offset ⁽³⁾ See test results disclaimer

DEPOSIT COMPOSITION⁽¹⁾

	%C ⁽⁴⁾	%Mn	%Si	%S	%P
Requirements AWS E309LT0-1 & E309LT0-4	0.04 max	0.5-2.5	1.0 max	0.03 max	0.04 max
Typical Results⁽³⁾ As-Welded with 100% CO ₂	≤0.03	1.0	0.8	≤ 0.01	≤ 0.02
As-Welded with 75% Ar/25% CO ₂	≤0.03	1.0	0.9	≤ 0.01	≤ 0.02
	%Ni	%Cr	%Mo	%Cu	%Bi
Requirements AWS E309LT0-1 & E309LT0-4	12.0-14.0	22.0-25.0	0.75 max	0.75 max	—
Typical Results⁽³⁾ As-Welded with 100% CO ₂	12.8-13.2	23.6-23.9	≤ 0.20	≤ 0.25	0.02
As-Welded with 75% Ar/25% CO ₂	12.9-13.3	23.9-24.1	≤ 0.20	≤ 0.25	0.02

⁽¹⁾Typical all weld metal, DC+ ⁽³⁾See test results disclaimer ⁽⁴⁾Requirement for E316T1-1 and E316T1-4 is 0.08% max. carbon

TYPICAL OPERATING PROCEDURES

Diameter, Polarity, Shielding Gas in (mm)	CTWD ⁽³⁾ mm (in)	Wire Feed Speed/ Voltage m/min (in/min)	Voltage (Volts)	Approx. Current (Amps)	Melt-Off Rate kg/hr (lb/hr)	Deposition Rate kg/hr (lb/hr)	Efficiency (%)
0.045 in (1.1 mm), DC+ 75% Ar/25% CO ₂	19 (3/4)	5.3 (210)	22-24	140	2.1 (4.6)	1.9 (4.2)	91.3
	19 (3/4)	8.9 (350)	24-26	185	3.9 (8.7)	3.4 (7.5)	86.2
	19 (3/4)	11.4 (450)	26-28	225	4.7 (10.3)	4.4 (9.6)	93.2
1/16 in (1.6 mm), DC+ 75% Ar/25% CO ₂	25 (1)	3.6 (140)	23-25	165	2.7 (5.9)	2.3 (5.0)	84.7
	25 (1)	6.4 (250)	25-27	235	4.8 (10.6)	4.2 (9.3)	87.7
	25 (1)	8.1 (320)	26-28	290	6.1 (13.5)	5.4 (12)	88.8

⁽³⁾To estimate ESO, subtract 1/4 in (6.0 mm) from CTWD. NOTE: Increase Voltage by 2V when using 100% CO₂

IMPORTANT: SPECIAL VENTILATION AND/OR EXHAUST REQUIRED

Fumes from the normal use of some welding products can contain significant quantities of components - such as chromium and manganese - which can lower the 5.0 mg/m³ maximum exposure guideline for general welding fume. BEFORE USE, READ AND UNDERSTAND THE SAFETY DATA SHEET (SDS) FOR THIS PRODUCT AND SPECIFIC INFORMATION PRINTED ON THE PRODUCT CONTAINER.

ULTRACORE® 309L P

Stainless | AWS E309T1-1, E309T1-4, E309LT1-1, E309LT1-4

KEY FEATURES

- Precision layer wound winding delivers steady spool payoff and more consistent feeding
- Smooth arc action with minimal spatter reduces post-weld cleaning
- Polished weld bead appearance reduces post-weld brushing

WELDING POSITIONS

All Positions

SHIELDING GAS

75% Ar/25% CO₂ 100% CO₂

CONFORMANCES

- AWS A5.22:** E309LT1-1, E309LT1-4
ASME SFA-5.22: E309LT1-1, E309LT1-4
CWB/CSA: E309LT1-1, E309LT1-4

TYPICAL APPLICATIONS

- Buffer layers and clad steels – overlays on CMn, mild steel or low alloy steels
- Dissimilar joints – stainless types 410, 304L, 321, and 316L to mild and low alloy steels

DIAMETERS / PACKAGING

Diameter in (mm)	10 lb (4.5 kg) PLW Plastic Spool (Vacuum Sealed Foil Bag)	33 lb (15 kg) PLW Plastic Spool (Vacuum Sealed Foil Bag)	400 lb (181 kg) Drum
0.045 (1.1)	ED037219	ED037127	ED037662
1/16 (1.6)		ED037128	ED037663

MECHANICAL PROPERTIES⁽¹⁾

	Yield Strength ⁽²⁾ MPa (ksi)	Tensile Strength MPa (ksi)	Elongation %	Ferrite Number
Requirements				
AWS E309LT1-1, E309LT1-4	Not Specified	520 (75) min	30 min	Not Specified
AWS E309T1-1, E309T1-4	Not Specified	550 (80) min	30 min	Not Specified
Typical Results⁽³⁾				
As-Welded with 100% CO ₂	434 (63)	565 (82)	33	—
As-Welded with 75% Ar/25% CO ₂	450 (65)	593 (86)	33	—

⁽¹⁾Typical all weld metal, DC+ ⁽²⁾ Measured with 0.2% offset ⁽³⁾ See test results disclaimer

DEPOSIT COMPOSITION⁽¹⁾

	%C ⁽⁴⁾	%Mn	%Si	%S	%P
Requirements AWS E309LT1-1 & E309LT1-4	0.04 max	0.5-2.5	1.0 max	0.03 max	0.04 max
Typical Results⁽³⁾ As-Welded with 100% CO ₂	≤0.03	1.0	0.8	≤ 0.01	≤ 0.02
As-Welded with 75% Ar/25% CO ₂	≤0.03	1.0	0.9	≤ 0.01	≤ 0.02
	%Ni	%Cr	%Mo	%Cu	%Bi
Requirements AWS E309LT1-1 & E309LT1-4	12.0-14.0	22.0-25.0	0.75 max	0.75 max	—
Typical Results⁽³⁾ As-Welded with 100% CO ₂	12.8-13.2	23.6-23.9	≤ 0.20	≤ 0.25	0.01
As-Welded with 75% Ar/25% CO ₂	12.9-13.3	23.9-24.1	≤ 0.20	≤ 0.25	0.01

⁽¹⁾Typical all weld metal, DC+ ⁽³⁾See test results disclaimer ⁽⁴⁾Requirement for E316T1-1 and E316T1-4 is 0.08% max. carbon

TYPICAL OPERATING PROCEDURES

Diameter, Polarity, Shielding Gas in (mm)	CTWD ⁽⁵⁾ mm (in)	Wire Feed Speed/ Voltage m/min (in/min)	Voltage (Volts)	Approx. Current (Amps)	Melt-Off Rate kg/hr (lb/hr)	Deposition Rate kg/hr (lb/hr)	Efficiency (%)
0.045 in (1.1 mm), DC+ 75% Ar/25% CO ₂	19 [3/4]	5.1 (200)	22-24	130	2.1 (4.6)	1.7 (3.8)	82.6
	19 [3/4]	8.4 (330)	24-26	180	3.4 (7.4)	2.8 (6.1)	82.4
	19 [3/4]	11.2 (440)	26-28	220	4.5 (10)	3.7 (8.1)	81
1/16 in (1.6 mm), DC+ 75% Ar/25% CO ₂	25 (1)	3.6 (140)	22-24	150	2.5 (5.6)	2.2 (4.8)	85.7
	25 (1)	5.0 (195)	24-26	190	3.6 (7.9)	3.0 (6.7)	84.8
	25 (1)	7.1 (280)	25-27	220	5.2 (11.4)	4.4 (9.6)	84.2

⁽⁵⁾To estimate ESO, subtract 1/4 in (6.0 mm) from CTWD. NOTE: Increase Voltage by 2V when using 100% CO₂

IMPORTANT: SPECIAL VENTILATION AND/OR EXHAUST REQUIRED

Fumes from the normal use of some welding products can contain significant quantities of components - such as chromium and manganese - which can lower the 5.0 mg/m³ maximum exposure guideline for general welding fume. BEFORE USE, READ AND UNDERSTAND THE SAFETY DATA SHEET (SDS) FOR THIS PRODUCT AND SPECIFIC INFORMATION PRINTED ON THE PRODUCT CONTAINER.

ULTRACORE® 316L

Stainless | AWS E316T0-1, E316T0-4, E316LT0-1, E316LT0-4

KEY FEATURES

- Precision layer wound winding delivers steady spool payoff and more consistent feeding
- Smooth arc action with minimal spatter reduces post-weld cleaning
- Polished weld bead appearance reduces post-weld brushing

WELDING POSITIONS

Flat & Horizontal

SHIELDING GAS

75% Ar/25% CO₂ 100% CO₂

CONFORMANCES

- AWS A5.22:** E316LT0-1, E316LT0-4
ASME SFA-5.22: E316LT0-1, E316LT0-4
CWB/CSA: E316LT0-1, E316LT0-4

TYPICAL APPLICATIONS

- 1.5 – 3% Mo austenitic stainless steel
- Suitable for Ti or Nb stabilized and nitrogen-bearing versions of the above alloys
- Applications requiring good resistance to pitting and general corrosion

DIAMETERS / PACKAGING

Diameter in (mm)	10 lb (4.5 kg) PLW Plastic Spool (Vacuum Sealed Foil Bag)	33 lb (15 kg) PLW Plastic Spool (Vacuum Sealed Foil Bag)
0.045 (1.1)	ED037220	ED037122
1/16 (1.6)		ED037123

MECHANICAL PROPERTIES⁽¹⁾

	Yield Strength ⁽²⁾ MPa (ksi)	Tensile Strength MPa (ksi)	Elongation %	Ferrite Number
Requirements				
AWS E316LT0-1, E316LT0-4	Not Specified	520 (75) min	30 min	Not Specified
AWS E316T0-1, E316T0-4	Not Specified	550 (80) min	30 min	Not Specified
Typical Results⁽³⁾				
As-Welded with 100% CO ₂	414 (60)	552 (80)	34	6-8
As-Welded with 75% Ar/25% CO ₂	421 (65)	565 (82)	34	8-11

⁽¹⁾Typical all weld metal, DC+ ⁽²⁾ Measured with 0.2% offset ⁽³⁾ See test results disclaimer

DEPOSIT COMPOSITION⁽¹⁾

	%C ⁽⁴⁾	%Mn	%Si	%S	%P
Requirements AWS E316LT0-1 & E316LT0-4	0.04 max	0.5-2.5	1.0 max	0.03 max	0.04 max
Typical Results⁽³⁾ As-Welded with 100% CO ₂	≤0.03	1.0	0.6	≤ 0.01	≤ 0.02
As-Welded with 75% Ar/25% CO ₂	≤0.03	1.1	0.7	≤ 0.01	≤ 0.02
	%Ni	%Cr	%Mo	%Cu	%Bi
Requirements AWS E316LT0-1 & E316LT0-4	11.0-14.0	17.0-20.0	2.0-3.0	0.75 max	—
Typical Results⁽³⁾ As-Welded with 100% CO ₂	12.3-12.5	18.0-18.5	2.5-2.8	≤ 0.25	0.02
As-Welded with 75% Ar/25% CO ₂	12.3-12.5	18.5-19.0	2.5-2.8	≤ 0.25	0.02

⁽¹⁾Typical all weld metal, DC+ ⁽³⁾See test results disclaimer ⁽⁴⁾Requirement for E316T1-1 and E316T1-4 is 0.08% max. carbon

TYPICAL OPERATING PROCEDURES

Diameter, Polarity, Shielding Gas in (mm)	CTWD ⁽³⁾ mm (in)	Wire Feed Speed/ Voltage m/min (in/min)	Voltage (Volts)	Approx. Current (Amps)	Melt-Off Rate kg/hr (lb/hr)	Deposition Rate kg/hr (lb/hr)	Efficiency (%)
0.045 in (1.1 mm), DC+ 75% Ar/25% CO ₂	19 (3/4)	5.3 (210)	22-24	130	2.2 (4.8)	1.9 (4.1)	85.4
	19 (3/4)	8.9 (350)	24-26	175	3.7 (8.2)	3.2 (7.0)	85.3
	19 (3/4)	11.4 (450)	26-28	210	4.6 (10.1)	4.1 (9.0)	89.1
1/16 in (1.6 mm), DC+ 75% Ar/25% CO ₂	25 (1)	3.6 (140)	23-25	155	2.7 (5.9)	2.3 (5.0)	84.7
	25 (1)	6.4 (250)	25-27	230	4.8 (10.6)	4.3 (9.4)	88.6
	25 (1)	8.1 (320)	26-28	280	6.2 (13.6)	5.5 (12.1)	88.9

⁽³⁾To estimate ESQ, subtract 1/4 in (6.0 mm) from CTWD. NOTE: Increase Voltage by 2V when using 100% CO₂

IMPORTANT: SPECIAL VENTILATION AND/OR EXHAUST REQUIRED

Fumes from the normal use of some welding products can contain significant quantities of components - such as chromium and manganese - which can lower the 5.0 mg/m³ maximum exposure guideline for general welding fume. BEFORE USE, READ AND UNDERSTAND THE SAFETY DATA SHEET (SDS) FOR THIS PRODUCT AND SPECIFIC INFORMATION PRINTED ON THE PRODUCT CONTAINER.

ULTRACORE® 316L P

Stainless | AWS E316T1-1, E316T1-4, E316LT1-1, E316LT1-4

KEY FEATURES

- Precision layer wound winding delivers steady spool payoff and more consistent feeding
- Smooth arc action with minimal spatter reduces post-weld cleaning
- Polished weld bead appearance reduces post-weld brushing

WELDING POSITIONS

All Positions

SHIELDING GAS

75% Ar/25% CO₂ 100% CO₂

CONFORMANCES

AWS A5.22: E316LT1-1, E316LT1-4
CWB/CSA: E316LT1-1, E316LT1-4

TYPICAL APPLICATIONS

- 1.5 – 3% Mo austenitic stainless steel
- Suitable for Ti or Nb stabilized and nitrogen-bearing versions of the above alloys
- Applications requiring good resistance to pitting and general corrosion

DIAMETERS / PACKAGING

Diameter in (mm)	10 lb (4.5 kg) PLW Plastic Spool (Vacuum Sealed Foil Bag)	33 lb (15 kg) PLW Plastic Spool (Vacuum Sealed Foil Bag)	400 lb (181 kg) Drum
0.045 (1.1)	ED037221	ED037129	ED037664
1/16 (1.6)		ED037130	ED037665

MECHANICAL PROPERTIES⁽¹⁾

	Yield Strength ⁽²⁾ MPa (ksi)	Tensile Strength MPa (ksi)	Elongation %	Ferrite Number
Requirements				
AWS E316LT1-1, E316LT1-4	Not Specified	520 (75) min	30 min	Not Specified
AWS E316T1-1, E316T1-4	Not Specified	550 (80) min	30 min	Not Specified
Typical Results⁽³⁾				
As-Welded with 100% CO ₂	414 (60)	552 (80)	34	6-8
As-Welded with 75% Ar/25% CO ₂	421 (65)	565 (82)	34	8-11

⁽¹⁾Typical all weld metal, DC+ ⁽²⁾ Measured with 0.2% offset ⁽³⁾ See test results disclaimer

DEPOSIT COMPOSITION⁽¹⁾

	%C ⁽⁴⁾	%Mn	%Si	%S	%P
Requirements AWS E316LT1-1 & E316LT1-4	0.04 max	0.5-2.5	1.0 max	0.03 max	0.04 max
Typical Results⁽³⁾ As-Welded with 100% CO ₂	≤0.03	1.0	0.6	≤ 0.01	≤ 0.02
As-Welded with 75% Ar/25% CO ₂	≤0.03	1.1	0.7	≤ 0.01	≤ 0.02
	%Ni	%Cr	%Mo	%Cu	%Bi
Requirements AWS E316LT1-1 & E316LT1-4	11.0-14.0	17.0-20.0	2.0-3.0	0.75 max	—
Typical Results⁽³⁾ As-Welded with 100% CO ₂	12.3-12.5	18.0-18.5	2.5-2.8	≤ 0.25	0.01
As-Welded with 75% Ar/25% CO ₂	12.3-12.5	18.5-19.0	2.5-2.8	≤ 0.25	0.01

⁽¹⁾Typical all weld metal, DC+ ⁽³⁾See test results disclaimer ⁽⁴⁾Requirement for E316T1-1 and E316T1-4 is 0.08% max. carbon

TYPICAL OPERATING PROCEDURES

Diameter, Polarity, Shielding Gas in (mm)	CTWD ⁽⁵⁾ mm (in)	Wire Feed Speed/ Voltage m/min (in/min)	Voltage (Volts)	Approx. Current (Amps)	Melt-Off Rate kg/hr (lb/hr)	Deposition Rate kg/hr (lb/hr)	Efficiency (%)
0.045 in (1.1 mm), DC+ 75% Ar/25% CO ₂	19 [3/4]	5.1 (200)	22-24	130	2.0 (4.5)	1.5 (3.3)	73.3
	19 [3/4]	8.4 (330)	24-26	180	3.3 (7.3)	2.6 (5.8)	79.4
	19 [3/4]	11.2 (440)	26-28	220	4.4 (9.7)	3.6 (7.9)	81.4
1/16 in (1.6 mm), DC+ 75% Ar/25% CO ₂	25 (1)	3.6 (140)	24-26	170	2.6 (5.7)	2.2 (4.8)	84.2
	25 (1)	5.0 (195)	24-26	200	3.6 (7.9)	3.0 (6.7)	84.8
	25 (1)	7.1 (280)	25-27	220	5.2 (11.4)	4.4 (9.7)	85

⁽⁵⁾To estimate ESQ, subtract 1/4 in (6.0 mm) from CTWD. NOTE: Increase Voltage by 2V when using 100% CO₂

IMPORTANT: SPECIAL VENTILATION AND/OR EXHAUST REQUIRED

Fumes from the normal use of some welding products can contain significant quantities of components - such as chromium and manganese - which can lower the 5.0 mg/m³ maximum exposure guideline for general welding fume. BEFORE USE, READ AND UNDERSTAND THE SAFETY DATA SHEET (SDS) FOR THIS PRODUCT AND SPECIFIC INFORMATION PRINTED ON THE PRODUCT CONTAINER.

SUPERCORE™ 308LCF

Stainless · AWS E308LT1-1/4 J

KEY FEATURES

- Controlled Low Ferrite (Range 3-6)
- Charpy V-Notch test results capable of exceeding 27 J (20 ft-lbf) @ -196°C (-320°F)
- Exceeds 15 mils (0.38 mm) of lateral expansion @ -196°C (-320°F)
- Batch Managed Inventory
- Q2 Lot® - Certificates showing deposit composition, ferrite number, and charpy impact properties tested @ -196°C (-320°F)

WELDING POSITIONS

All

SHIELDING GAS

80% Argon / 20% CO₂ or 100% CO₂

DIAMETERS / PACKAGING

Diameter mm (in)	15 kg (33 lb) Spool (Vacuum Sealed Foil Bag)
1.2 (0.045)	SC308LCF-12
1.6 (1/16)	SC308LCF-16

MECHANICAL PROPERTIES^(a) – As Required per AWS A5.22

	Yield Strength ^(b) MPa (ksi)	Tensile Strength MPa (ksi)	Elongation %	Charpy V-Notch J (ft-lb) -196°C (-320°F)	Lateral Expansion mm (mils) -196°C (-320°F)
Requirements AWS A5.22: E308LT1-1/4 J As-Welded with 80% Ar/20% CO ₂	Not Specified	520 (75) min	30 min	Not Specified	0.38 (15)
Typical Results^(b) As-Welded with 80% Ar/20% CO ₂	400 (58)	540 (78)	50	36 (27)	0.70 (28)

DEPOSIT COMPOSITION^(a) – As Required per AWS A5.22

	%C	%Mn	%Si	%S	%P
Requirements As-Welded with 80% Ar/20% CO ₂	0.04 max	0.5 - 2.5	1.0 max	0.03 max	0.04 max
Typical Results^(b)	0.03	1.4	0.6	0.01	0.02
	%Cr	%Ni	%Mo	%Cu	%FN
Requirements As-Welded with 80% Ar/20% CO ₂	18.0-21.0	9.0-11.0	0.75	0.75	Not Specified
Typical Results^(b)	18.6	10.5	0.1	0.1	3 - 6

TYPICAL OPERATING PROCEDURES

Diameter, Polarity Shielding Gas	CTWD ^(b) mm (in)	Wire Feed Speed m/min (in/min)	Voltage (Volts)	Approx. Current (Amps)	Melt-Off Rate kg/hr (lb/hr)	Deposition Rate kg/hr (lb/hr)	Efficiency (%)
1.2 mm (0.045 in), DC+ 75% Ar/25% CO ₂	19 (3/4)	5.1 (200)	23-26	120	2.1 (4.7)	1.8 (4.0)	85
	19 (3/4)	7.6 (300)	25-28	155	3.2 (7.0)	2.7 (6.0)	86
	19 (3/4)	10.2 (400)	27-30	185	4.3 (9.4)	3.6 (7.9)	84

^(a)Typical all weld metal ^(b)Measured with 0.2% offset ^(c)See test results disclaimer

<p>IMPORTANT: SPECIAL VENTILATION AND/OR EXHAUST REQUIRED</p> <p>Fumes from the normal use of some welding products can contain significant quantities of components - such as chromium and manganese - which can lower the 5.0 mg/m³ maximum exposure guideline for general welding fume.</p> <p>BEFORE USE, READ AND UNDERSTAND THE SAFETY DATA SHEET (SDS) FOR THIS PRODUCT AND SPECIFIC INFORMATION PRINTED ON THE PRODUCT CONTAINER.</p>

CONFORMANCES

AWS A5.22:	E308LT1-1/4 J
ASME SFA 5.22:	E308LT1-1/4 J
ISO 17633-A:	T 19 9 L P C12, T 19 9 L P M212
ISO 17633-B:	TS 308L-F C11, TS 308L-F M211

TYPICAL APPLICATIONS

- LNG Storage
- Cryogenic Vessels and Piping

TYPICAL BASE METALS

- 304L stainless steel
- 18/8 steels with service temperatures down to -196°C (-320°F)

SUPERCORE™ 316LCF

Stainless · AWS E316LT1-1/4 J

KEY FEATURES

- Controlled Low Ferrite (Range 3-5)
- Charpy V-Notch test results capable of exceeding 27 J (20 ft-lbf) @ -196°C (-320°F)
- Exceeds 15 mils (0.38 mm) of lateral expansion @ -196°C (-320°F)
- Batch Managed Inventory
- Q2 Lot® - Certificates showing deposit composition, ferrite number, and charpy impact properties tested @ -196°C (-320°F)

WELDING POSITIONS

All

SHIELDING GAS

80% Argon/20% CO₂ or 100% CO₂

DIAMETERS / PACKAGING

Diameter mm (in)	15 kg (33 lb) Spool (Vacuum Sealed Foil Bag)
1.2 (0.045)	SC316LCF-12
1.6 (1/16)	SC316LCF-16

CONFORMANCES

AWS A5.22:	E316LT1-1/4 J
ASME SFA 5.22:	E316LT1-1/4 J
ISO 17633-A	T 19 12 3 L P C12, M21
ISO 17633-B:	S 316L-F C 11, M211

TYPICAL APPLICATIONS

- LNG Storage
- Cryogenic Vessels and Piping

TYPICAL BASE METALS

316L stainless steel

MECHANICAL PROPERTIES⁽¹⁾ – As Required per AWS A5.22

	Yield Strength ⁽²⁾ MPa (ksi)	Tensile Strength MPa (ksi)	Elongation %	Charpy V-Notch J (ft-lb) -196°C (-320°F)	Lateral Expansion mm (mils) -196°C (-320°F)
Requirements AWS E316LT1-1/4 J As-Welded with 80% Ar/20% CO ₂	Not Specified	485 (70) min	30 min	Not Specified	0.38 (15)
Typical Results⁽³⁾ As-Welded with 80% Ar/20% CO ₂	410 (69)	550 (80)	40	34 (25)	0.55 (22)

DEPOSIT COMPOSITION⁽¹⁾ – As Required per AWS A5.22

	%C	%Mn	%Si	%S	%P
Requirements As-Welded with 80% Ar/20% CO ₂	0.04 max	0.5-2.5	1.0 max	0.03 max	0.04 max
Typical Results⁽³⁾	0.03	1.4	0.6	0.01	0.02
	%Cr	%Ni	%Mo	%Cu	%FN
Requirements As-Welded with 80% Ar/20% CO ₂	17.0-20.0	11.0-14.0	2.0-3.0	0.75	Not Specified
Typical Results⁽³⁾	18.0	12.4	2.2	0.1	3 - 5

TYPICAL OPERATING PROCEDURES

Diameter, Polarity Shielding Gas	CTWD ⁽⁴⁾ mm (in)	Wire Feed Speed m/min (in/min)	Voltage (Volts)	Approx. Current (Amps)	Melt-Off Rate kg/hr (lb/hr)	Deposition Rate kg/hr (lb/hr)	Efficiency (%)
1.2 mm (0.045 in), DC+ 75% Ar/25% CO ₂	19 (3/4)	5.1 (200)	23-26	120	2.1 (4.7)	1.8 (4.0)	85
	19 (3/4)	7.6 (300)	25-28	155	3.2 (7.0)	2.7 (6.0)	86
	19 (3/4)	10.2 (400)	27-30	185	4.3 (9.4)	3.6 (7.9)	84

⁽¹⁾Typical all weld metal ⁽²⁾Measured with 0.2% offset ⁽³⁾See test results disclaimer

IMPORTANT: SPECIAL VENTILATION AND/OR EXHAUST REQUIRED

Fumes from the normal use of some welding products can contain significant quantities of components - such as chromium and manganese - which can lower the 5.0 mg/m³ maximum exposure guideline for general welding fume. BEFORE USE, READ AND UNDERSTAND THE SAFETY DATA SHEET (SDS) FOR THIS PRODUCT AND SPECIFIC INFORMATION PRINTED ON THE PRODUCT CONTAINER.

SUPERCORE™ 347

Stainless ▪ AWS E347T0-1/4

KEY FEATURES

- High deposition flat / horizontal wire
- Improved bead appearance
- Q2 Lot® - Certificate showing deposit composition, ferrite number, and Charpy impact properties tested @ -196°C (-320°F)

WELDING POSITIONS

Flat and horizontal

SHIELDING GAS

75-80% Argon / Balance CO₂
100% CO₂

CONFORMANCES

AWS A5.22 E347T0-1/4
BS EN ISO 17633-A T19 9 Nb R C/M 3
BS EN ISO 17633-B TS347-FB0

TYPICAL APPLICATIONS

- Food
- Brewery
- Pharmaceutical Equipment
- Architectural
- General Fabrication

DIAMETERS / PACKAGING

Diameter mm (in)	15 kg (33 lb) Spool (Vacuum Sealed Foil Bag)
1.2 (0.045)	ED034129, SC347-12*

*The Metrode part number will be replacing the current EDO numbers after the inventory has been depleted.

MECHANICAL PROPERTIES⁽¹⁾ - As Required per AWS A5.22

	Yield Strength ⁽²⁾ MPa (ksi)	Tensile Strength MPa (ksi)	Elongation %	Charpy V-Notch J (ft·lbf) @ 20°C (68°F)
Requirements AWS E347T0-1/4	Not Specified	520 (75)	30 min	-
Typical Results⁽³⁾ As-Welded	435 (63)	600 (87)	47	90 (67)

DEPOSIT COMPOSITION⁽¹⁾ - As Required per AWS A5.22

	%C	%Mn	%Si	%S	%P	%Cr
Requirements AWS E347T0-1/4	0.08 max	0.5-2.5	1.0 max	0.03 max	0.04 max	18.0-21.0
Typical Results⁽³⁾	0.03	1.2	0.4	0.01	0.02	19
	%Ni	%Mo	%Nb	%Cu	FN	
Requirements AWS E347T0-1/4	9.0-11.0	0.75 max	8 x C min - 1.0 max	0.75 max	4 - 12	
Typical Results⁽³⁾	10.5	0.1	0.5	0.1	8.0	

TYPICAL OPERATING PROCEDURES

Diameter mm (in)	Amp-Volt Range	Typical	Stickout mm (in)
1.2 (0.045) DC+	120-280A 22-34V	180A, 29V	15 - 20 (5/8 - 1)

⁽¹⁾Typical all weld metal. ⁽²⁾Measured with 0.2% offset. ⁽³⁾See test results disclaimer
NOTE: Additional test data available upon request.

<p>IMPORTANT: SPECIAL VENTILATION AND/OR EXHAUST REQUIRED</p> <p>Fumes from the normal use of some welding products can contain significant quantities of components - such as chromium and manganese - which can lower the 5.0 mg/m³ maximum exposure guideline for general welding fume.</p> <p>BEFORE USE, READ AND UNDERSTAND THE SAFETY DATA SHEET (SDS) FOR THIS PRODUCT AND SPECIFIC INFORMATION PRINTED ON THE PRODUCT CONTAINER.</p>
--

SUPERCORE® 2205P

Stainless · AWS E2209T1-1/4

KEY FEATURES

- Smooth all position weldability
- Vacuum sealed pack
- Excellent slag removal
- Q2 Lot® – Certificate showing deposit composition, ferrite number, and charpy impact properties tested @ -196°C (-320°F)

WELDING POSITIONS

All

SHIELDING GAS

80% Argon / 20% CO₂
100% CO₂

CONFORMANCES

AWS A5.22: E2209T1-1/4
BS EN ISO 17633-A: T22 9 3 N L R C1 3/ M21 3
BS EN ISO 17633-B: TS 2209-F C 1 0/ M21 0

TYPICAL APPLICATIONS

- Duplex Stainless Pipe, Plate, Fittings and Forgings
- Offshore
- Chemical/Petrochemical
- Pipework Systems
- Flowlines
- Risers
- Manifolds

DIAMETERS / PACKAGING

Diameter mm [in]	15 kg [33 lb] Spool (Vacuum Sealed Foil Bag)
1.2 [0.045]	SC2205P-12

MECHANICAL PROPERTIES⁽¹⁾ - As Required per AWS A5.22

	Yield Strength ⁽²⁾ MPa [ksi]	Tensile Strength MPa [ksi]	Elongation %	Charpy V-Notch J [ft-lbf]			Hardness HV _{0.05} ⁽⁴⁾
				@ -20°C [-40°F]	@ -50°C [-58°F]	@ -75°C [-103°F]	
Requirements AWS E2209T1-1/4	Not Specified	690 [100]	20 min	–	–	–	–
Typical Results⁽³⁾ As-Welded with 80% Ar/20% CO ₂	630 [91]	800 [116]	32	65 [48]	55 [41]	30 [22]	270

DEPOSIT COMPOSITION⁽¹⁾ - As Required per AWS A5.22

	%C	%Mn	%Si	%S	%P	%Cr
Requirements AWS E2209T1-1/4	0.04 max	0.5-2.0	1.0 max	0.03 max	0.04 max	21.0 - 24.0
Typical Results⁽³⁾	0.03	1.2	0.7	<0.01	0.02	23
	%Ni	%Mo	%Cu	%N	PRE ⁽⁵⁾	
Requirements AWS E2209T1-1/4	7.5-10.0	2.5-4.0	0.75 max	0.08-0.20	Not Specified	
Typical Results⁽³⁾	9.2	3.1	0.1	0.12	35.0	

TYPICAL OPERATING PROCEDURES⁽⁶⁾

Diameter mm [in]	Voltage [volts]	Amperage [amps]	Typical	CTWD mm [in]
1.2 [0.045] DC+ 80% Ar/20% CO	22-34	120-250	150A / 25V	15-20 [5/8 - 1]

⁽¹⁾Typical all weld metal. ⁽²⁾Measured with 0.2% offset. ⁽³⁾See test results disclaimer. ⁽⁴⁾Industry specific data, not required by AWS. ⁽⁵⁾PRE [Pitting Resistance Equivalent]= Cr + 3.3Mo+16N.
⁽⁶⁾Procedures are for 80% Argon/20% CO₂. Increase voltage by approximately 3V for 100% CO₂. NOTE: Additional test data available upon request.

IMPORTANT: SPECIAL VENTILATION AND/OR EXHAUST REQUIRED

Fumes from the normal use of some welding products can contain significant quantities of components - such as chromium and manganese - which can lower the 5.0 mg/m³ maximum exposure guideline for general welding fume. BEFORE USE, READ AND UNDERSTAND THE SAFETY DATA SHEET (SDS) FOR THIS PRODUCT AND SPECIFIC INFORMATION PRINTED ON THE PRODUCT CONTAINER.

SUPERCORE™ 2507P

Stainless · AWS E2594T1-4

KEY FEATURES

- High resistance to pitting attack in chloride environments (i.e. Seawater)
- High deposition rates
- Vacuum sealed pack
- High resistance to chloride induced stress corrosion cracking
- Q2 Lot® - Certificate showing deposit composition, ferrite number, and charpy impact properties tested @ -196°C (-320°F)

WELDING POSITIONS

All

CONFORMANCES

AWS A5.22M: E2594T1-4
 EN ISO 17633-A: T25 9 4 N L R M21 2

TYPICAL INDUSTRY SEGMENTS

- Duplex Stainless Steel Plates and Vessels
- Duplex Stainless Steel Pipe and Fittings
- Offshore
- Chemical/Petrochemical
- Pipework systems, flowlines, risers, and manifold

SHIELDING GAS

80% Argon / 20% CO₂

DIAMETERS / PACKAGING

Diameter in (mm)	15 kg (33 lb) Spool (Vacuum Sealed Foil Bag)
1.2 (0.045)	SC2507P-12

MECHANICAL PROPERTIES⁽¹⁾ - As Required per AWS A5.22

	Yield Strength ⁽²⁾ MPa (ksi)	Tensile Strength MPa (ksi)	Elongation %	Charpy V-Notch J (ft-lbf)		
				@ 20°C (68°F)	@ -20°C (-40°F)	@ -50°C (-58°F)
Requirements AWS E2594T1-4	Not Specified	760 (110) min	15 min	-	-	-
Typical Results⁽³⁾ As-Welded with 80% Ar/20% CO ₂	660 (96)	870 (126)	30	60 (44)	45 (33)	35 (26)

DEPOSIT COMPOSITION⁽¹⁾ - As Required per AWS A5.22

	%C	%Mn	%Si	%S	%P	%Cr
Requirements AWS E2594T1-4	0.04 max	0.5-2.5	1.0 max	0.03 max	0.04 max	24.0-27.0
Typical Results⁽³⁾	0.03	1.0	0.50	0.01	0.02	24.5
	%Ni	%Mo	%Cu	%W	%N	PRE ⁽⁵⁾
Requirements AWS E2594T1-4	8.0-10.5	2.5-4.5	1.5 max	1.0 max	0.20-0.30	40 min
Typical Results⁽³⁾	9.3	3.8	0.05	0.05	0.23	41

TYPICAL OPERATING PROCEDURES

Diameter mm (in)	Amp-Volt Range	Typical	Stickout mm (in)
1.2 (0.045) DC+ 80% Ar/20% CO ₂	120-250A, 22-32V	150A, 25V	15-20 (5/8-1)

⁽¹⁾Typical all weld metal. ⁽²⁾Measured with 0.2% offset. ⁽³⁾See test results disclaimer ⁽⁴⁾Industry specific data, not required by AWS. ⁽⁵⁾PRE (pitting resistance equivalent) = Cr + 3.3Mo + 16N.
 NOTE: Additional test data available upon request.

<p>IMPORTANT: SPECIAL VENTILATION AND/OR EXHAUST REQUIRED</p> <p>Fumes from the normal use of some welding products can contain significant quantities of components - such as chromium and manganese - which can lower the 5.0 mg/m³ maximum exposure guideline for general welding fume.</p> <p>BEFORE USE, READ AND UNDERSTAND THE SAFETY DATA SHEET (SDS) FOR THIS PRODUCT AND SPECIFIC INFORMATION PRINTED ON THE PRODUCT CONTAINER.</p>
--

SUPERCORE™ 308HP

Stainless · AWS E308HT1 - 1/4

KEY FEATURES

- Designed for strength and resistance to corrosion
- Used for joining austenitic stainless steels used at elevated temperatures
- Enhanced carbon electrode for high temperature applications
- Higher carbon content for high temperature applications

WELDING POSITIONS

All

SHIELDING GAS

80% Argon / 20% CO₂
100% CO₂

CONFORMANCES

AWS A5.22: E308HT1 - 1/4
EN ISO 17633-B TS 308H-F C1 1, TS 308H-F M21 1

TYPICAL APPLICATIONS

- Marine
- Chemical process
- Papermaking
- Food processing
- Petrochemical

DIAMETERS / PACKAGING

Diameter in (mm)	15 kg (33 lb) Spool (Vacuum Sealed Foil Bag)
1.2 (0.045)	SC308HP-12

MECHANICAL PROPERTIES⁽¹⁾ – As Required per AWS A5.22

	Yield Strength ⁽²⁾ MPa (ksi)	Tensile Strength MPa (ksi)	Elongation %	Charpy V-Notch J (ft·lbf)	
				@-20°C [-4°F]	@-50°C [-58°F]
Requirements AWS E308HT1-1/4 As-Welded	-	550 (80)	30 min	-	-
Typical Results⁽³⁾ As-Welded with 80% Ar/20% CO ₂	420 (61)	620 (90)	40	100 (74)	

DEPOSIT COMPOSITION⁽¹⁾ – As Required per AWS A5.22

	%C	%Mn	%Si	%S	%P
Requirements AWS E308HT1-1/4	0.04-0.08	0.5 - 2.5	1.0 max	0.03 max	0.04 max
Typical Results⁽³⁾	0.05	1.3	0.5	0.01	0.02
	%Cr	%Ni	%Mo	%Cu	FN
Requirements AWS E308HT1-1/4	18.0 - 21.0	9.0-11.0	0.75 max	0.75 max	Not Specified
Typical Results⁽³⁾	18.8	9.5	0.1	0.1	5

TYPICAL OPERATING PROCEDURES

Diameter mm (in)	Amp Range	Volt Range	Stickout mm (in)
1.2 (0.045) DC+ 80% Ar/20% CO ₂	120-250	22-32	12 - 20 (1/2-1)

⁽¹⁾ Typical all weld metal ⁽²⁾ Measured with 0.2% offset ⁽³⁾ See test results disclaimer

IMPORTANT: SPECIAL VENTILATION AND/OR EXHAUST REQUIRED

Fumes from the normal use of some welding products can contain significant quantities of components - such as chromium and manganese - which can lower the 5.0 mg/m³ maximum exposure guideline for general welding fume. BEFORE USE, READ AND UNDERSTAND THE SAFETY DATA SHEET (SDS) FOR THIS PRODUCT AND SPECIFIC INFORMATION PRINTED ON THE PRODUCT CONTAINER.

SUPERCORE™ 317LP

Stainless · AWS E317LT1-1/4

KEY FEATURES

- Used to weld 317/317L stainless steels
- Improved resistance to pitting in high chloride environments

WELDING POSITIONS

All

SHIELDING GAS

80% Argon / 20% CO₂
100% CO₂

CONFORMANCES

AWS A5.22: E317LT1-1/4
EN ISO 17633-B TS 317L-F C1 1, TS 317L-F M21 1

TYPICAL APPLICATIONS

- Marine
- Chemical process
- Papermaking
- Food processing

DIAMETERS / PACKAGING

Diameter in (mm)	15 kg (33 lb) Spool (Vacuum Sealed Foil Bag)
1.2 (0.045)	SC317LP-12

MECHANICAL PROPERTIES⁽¹⁾ – As Required per AWS A5.22

	Yield Strength ⁽²⁾ MPa (ksi)	Tensile Strength MPa (ksi)	Elongation %	Charpy V-Notch J (ft-lbf)		Hardness HV ₁₀
				@20°C (68°F)	@-50°C (-58°F)	
Requirements AWS E317LT1-1/4 As-Welded	Not Specified	520 (75)	20 min	-	-	-
Typical Results⁽³⁾ As-Welded	440 (64)	570 (83)	27	30 (22)	55 (41)	220

DEPOSIT COMPOSITION⁽¹⁾ – As Required per AWS A5.22

	%C	%Mn	%Si	%S	%P	%Cr
Requirements AWS E317LT1-1/4	0.04 max	0.5-2.5	1.0 max	0.3 max	0.04 max	18.0-21.0
Typical Results⁽³⁾	0.03	1.0	0.6	0.02	0.02	19.0
	%Ni	%Mo	%Cu	%N	FN	
Requirements AWS E317LT1-1/4	12.0-14.0	3.0-4.0	0.75 max	Not Specified	Not specified	
Typical Results⁽³⁾	13	3.5	0.1	0.07	6	

TYPICAL OPERATING PROCEDURES

Diameter mm (in)	Amp Range	Volt Range	Stickout mm (in)
1.2 (0.045) DC+ 80% Ar/20% CO ₂	120-280	22-34	15-20 (5/8-1)

⁽¹⁾ Typical all weld metal ⁽²⁾ Measured with 0.2% offset ⁽³⁾ See test results disclaimer

IMPORTANT: SPECIAL VENTILATION AND/OR EXHAUST REQUIRED

Fumes from the normal use of some welding products can contain significant quantities of components - such as chromium and manganese - which can lower the 5.0 mg/m³ maximum exposure guideline for general welding fume. BEFORE USE, READ AND UNDERSTAND THE SAFETY DATA SHEET (SDS) FOR THIS PRODUCT AND SPECIFIC INFORMATION PRINTED ON THE PRODUCT CONTAINER.

SUPERCORE™ 16.8.2P

Stainless

KEY FEATURES

- Suited for the most demanding vertical and overhead welding applications, including fixed pipework for ASME

WELDING POSITIONS

All

SHIELDING GAS

80% Argon / 20% CO₂

CONFORMANCES

BS EN ISO 17633-B

[Nearest TS16-8-2-FM1]

TYPICAL APPLICATIONS

- Furnace parts
- Gas and steam turbine
- Petrochemical
- Chemical process plants
- Power generation industries

DIAMETERS / PACKAGING

Diameter in (mm)	15 kg (33 lb) Spool (Vacuum Sealed Foil Bag)
1.2 (0.045)	SC1682P-12

MECHANICAL PROPERTIES⁽¹⁾

	Yield Strength ⁽²⁾ MPa (ksi)	Tensile Strength MPa (ksi)	Elongation %		Charpy V-Notch J (ft-lbf)		Hardness HV ₁₀
			4.0 dia	5.0 dia	@-20°C [-4°F]	@-196°C [-320°F]	
Typical Results ⁽³⁾ As-Welded	410 [59]	620 [90]	42	42	100 [74]	45 [33]	-

DEPOSIT COMPOSITION⁽¹⁾

	%C	%Mn	%Si	%S	%P
Typical Results ⁽³⁾	0.05	1.2	0.5	0.01	0.02
	%Cr	%Ni	%Mo	%Cu	FN
Typical Results ⁽³⁾	16.2	9.2	1.1	0.1	4

TYPICAL OPERATING PROCEDURES

Diameter mm (in)	Amp-Volt Range	Volt Range	Typical	Stickout mm (in)
1.2 (0.045) DC+ 80% Ar/20% CO ₂	120-280A	22-34V	180A, 29V	15-20 [5/8-1]

⁽¹⁾ Typical all weld metal ⁽²⁾ Measured with 0.2% offset ⁽³⁾ See test results disclaimer

IMPORTANT: SPECIAL VENTILATION AND/OR EXHAUST REQUIRED

Fumes from the normal use of some welding products can contain significant quantities of components - such as chromium and manganese - which can lower the 5.0 mg/m³ maximum exposure guideline for general welding fume. BEFORE USE, READ AND UNDERSTAND THE SAFETY DATA SHEET (SDS) FOR THIS PRODUCT AND SPECIFIC INFORMATION PRINTED ON THE PRODUCT CONTAINER.

SUPERCORE™ Z100XP

Stainless · AWS E2594T1-4

KEY FEATURES

- Designed for strength and resistance to corrosion
- Used for joining super duplex stainless steels
- Superior resistance to stress corrosion cracking (SCC) and pitting corrosion
- The addition of Cu and W provides superior resistance to sulphuric and hydrochloric acids compared to similar alloys without these metals

WELDING POSITIONS

All

SHIELDING GAS

80% Argon / 20% CO₂

DIAMETERS / PACKAGING

Diameter in (mm)	15 kg (33 lb) Spool (Vacuum Sealed Foil Bag)
1.2 (0.045)	SCZ100XP-12

MECHANICAL PROPERTIES⁽¹⁾ – As Required per AWS A5.22

	Yield Strength ⁽²⁾ MPa (ksi)	Tensile Strength MPa (ksi)	Elongation %	Charpy V-Notch J (ft-lbf)		Hardness HV ₁₀
				@-20°C (-4°F)	@-50°C (-58°F)	
Requirements AWS E2594T1-4	Not specified	760 (110) min	15 min	-	-	-
Typical Results⁽³⁾	690	880	25	40 (30)	32 (24)	280

DEPOSIT COMPOSITION⁽¹⁾ – As Required per AWS A5.22

	%C	%Mn	%Si	%S	%P	%Cr
Requirements AWS E2594T1-4	0.04 max	0.5-2.5	1.0 max	0.03 max	0.04 max	24.0-27.0
Typical Results⁽³⁾	0.03	1.0	0.5	0.005	0.02	24.5
	%Ni	%Mo	%Cu	%N	%W	PRE ⁽⁴⁾
Requirements AWS E2594T1-4	8.0-10.5	2.5-4.5	1.5 max	0.20-0.30	1.0 max	Not specified
Typical Results⁽³⁾	9.1	3.7	0.6	0.22	0.6	41

TYPICAL OPERATING PROCEDURES

Diameter mm (in)	Amp Range	Volt Range	Stickout mm (in)
1.2 (0.045) DC+ 80% Ar/20% CO ₂	120-250	22-34	15-20 (5/8-1)

⁽¹⁾ Typical all weld metal ⁽²⁾ Measured with 0.2% offset ⁽³⁾ See test results disclaimer ⁽⁴⁾ PRE [Pitting Resistance Equivalent]= Cr + 3.3Mo+16N.

IMPORTANT: SPECIAL VENTILATION AND/OR EXHAUST REQUIRED

Fumes from the normal use of some welding products can contain significant quantities of components - such as chromium and manganese - which can lower the 5.0 mg/m³ maximum exposure guideline for general welding fume. BEFORE USE, READ AND UNDERSTAND THE SAFETY DATA SHEET (SDS) FOR THIS PRODUCT AND SPECIFIC INFORMATION PRINTED ON THE PRODUCT CONTAINER.

LINCOLNWELD® 308/308L

Stainless · AWS ER308, ER308L

KEY FEATURES

- Designed to be used primarily with basic fluxes
- Versatile electrode designed to weld several types of austenitic steels
- Balanced chromium and nickel levels provide enough ferrite in the weld metal for high resistance to hot cracking
- Provides a weld deposit with reduced carbon levels (0.03% max) that offers increased resistance to inter-granular corrosion
- Q2 Lot® - Certificate showing actual wire composition and calculated ferrite number (FN) available online

RECOMMENDED FLUXES

Lincolnweld® 801, 802, 880, 880M, 882, P2007, ST-100, P2000

DIAMETERS / PACKAGING

Diameter in (mm)	55 lb (25 kg) Steel Spool	500 lb (227 kg) Speed Feed® Drum	750 lb (340 kg) Speed Feed® Drum	500 lb (227 kg) Speed Feed® Reel	600 lb (272 kg) Speed Feed® Reel
1/16 [1.6]	ED035160				
5/64 [2.0]	ED033147				
3/32 [2.4]	ED035162	ED036446	ED036540	ED035161	ED034478
1/8 [3.2]	ED035163	ED036440	ED036604		
5/32 [4.0]	ED035165	ED036441			

CONFORMANCES

AWS A5.9:	ER308, ER308L
ASME SFA-5.9:	ER308, ER308L
CWB/CSA:	ER308, ER308L
ISO 14343-B:	SS308L
ABS:	ER308, ER308L

TYPICAL APPLICATIONS

- ASTM A743, A744 Types CF-8 and CF-3
- ASTM A240 Types 302, 304, 304L
- For joining the more common austenitic stainless steel grades referred to as "18-8" steels
- Type 308L is ideal for welding Type 304L stainless steels

MECHANICAL PROPERTIES⁽¹⁾ – As Required per AWS A5.9

	Yield Strength ⁽²⁾ MPa (ksi)	Tensile Strength MPa (ksi)	Elongation %	Ferrite Number
Test Results ^(3,5) - As-Welded with Lincolnweld P2007	380 [55]	565 [82]	42	15

WIRE COMPOSITION⁽¹⁾

	%C ⁽⁴⁾	%Cr	%Ni	%Mo	%Mn	%Si
Requirements - AWS ER308, ER308L	0.03 max	19.5-22.0	9.0-11.0	0.75 max	1.0 - 2.5	0.30 - 0.65
Typical Results ⁽⁶⁾						
Wire Composition	0.02	20.1	9.8	0.10	1.8	0.50
All Weld Metal Composition ⁽⁵⁾	0.02	19.0 - 19.5	9.8	0.10	1.5 - 1.9	0.50 - 0.80

TYPICAL OPERATING PROCEDURES

Diameter in (mm)	Wire Feed Speed m/min (in/min)	Voltage (volts)	Current (amps)
5/64 [2.0]	2.0-6.1 (80-240)	24-30	190-500
3/32 [2.4]	1.5-5.3 (60-210)	26-32	195-575
1/8 [3.2]	0.9-2.8 (35-110)	28-34	200-700
5/32 [4.0]	0.8-1.9 (30-75)	30-36	320-775

⁽¹⁾Typical all weld metal. ⁽²⁾Measured with 0.2% offset. ⁽³⁾See test results disclaimer ⁽⁴⁾AWS Requirement for ER308 is 0.08% max. carbon.

⁽⁵⁾Results shown correspond with the recommended Lincolnweld® and Blue Max® fluxes listed above, but not required per AWS A5.9-93.

IMPORTANT: SPECIAL VENTILATION AND/OR EXHAUST REQUIRED

Fumes from the normal use of some welding products can contain significant quantities of components - such as chromium and manganese - which can lower the 5.0 mg/m³ maximum exposure guideline for general welding fume. BEFORE USE, READ AND UNDERSTAND THE SAFETY DATA SHEET (SDS) FOR THIS PRODUCT AND SPECIFIC INFORMATION PRINTED ON THE PRODUCT CONTAINER.

LINCOLNWELD® 308/308H

Stainless · AWS ER308H

KEY FEATURES

- Used to weld unstabilized austenitic stainless steels such as 302, 304H and 305
- Provides a high carbon deposit (minimum of .04% carbon) for high temperature applications
- The high carbon deposit provides creep strength and higher tensile strength at elevated service temperatures
- Q2 Lot® - Certificates showing actual wire chemistry available online

CONFORMANCES

AWS A5.9: ER308, ER308H

ASME SFA-5.9: ER308, ER308H

TYPICAL APPLICATIONS

- Chemical
- Petrochemical industries
- Distillery
- Dairy
- Restaurant Equipment
- Catalytic Crackers
- Pulp and Paper

RECOMMENDED FLUXES

P2007, P2000

DIAMETERS / PACKAGING

Diameter in (mm)	55 lb (25 kg) Steel Spool
3/32 (2.4)	ED035158
1/8 (3.2)	ED035159

WIRE COMPOSITION⁽¹⁾ – As Required per AWS A5.9

	%C	%Cr	%Ni	%Mo	%Mn
Requirements AWS ER308H	0.04 - 0.08	19.5 - 22.0	9.00 - 11.00	0.50 max	1.0 - 2.5
Typical Results⁽²⁾	0.06	19.9	9.7	0.07	1.8
	%Si	%P	%S	%Cu	FN
Requirements AWS ER308H	0.30 - 0.65	0.04 max	0.03 max	0.75 max	Not Required
Typical Results⁽²⁾	0.44	0.02	0.006	0.10	5 - 12

TYPICAL OPERATING PROCEDURES

Diameter in (mm)	Voltage (volts)	Amperage
3/32 (2.4)	28-30	275-350
1/8 (3.2)	29-32	350-450

⁽¹⁾Typical all weld metal. ⁽²⁾See test results disclaimer

IMPORTANT: SPECIAL VENTILATION AND/OR EXHAUST REQUIRED

Fumes from the normal use of some welding products can contain significant quantities of components - such as chromium and manganese - which can lower the 5.0 mg/m³ maximum exposure guideline for general welding fume. BEFORE USE, READ AND UNDERSTAND THE SAFETY DATA SHEET (SDS) FOR THIS PRODUCT AND SPECIFIC INFORMATION PRINTED ON THE PRODUCT CONTAINER.

LINCOLNWELD® 308/308LCF

Stainless · AWS ER308/308L

KEY FEATURES

- Controlled Low Ferrite (Range 3-8)
- Charpy V-Notch test results capable of exceeding 27 J (20 ft-lbf) @ -196°C (-320°F)
- Exceeds 15 mils (0.38 mm) of lateral expansion @ -196°C (-320°F)
- Batch Managed Inventory
- Q2 Lot® - Certificate showing deposit composition, ferrite number, and charpy impact properties tested at -196°C (-320°F)

CONFORMANCES

- AWS A5.9:** ER308, ER308L
- ASME SFA-5.9:** ER308, ER308L
- ABS:** ER308, ER308L

TYPICAL APPLICATIONS

- LNG Storage
- Cryogenic Vessels and Piping

RECOMMENDED FLUX

Lincolnweld® P2007

TYPICAL BASE METALS

- 304L stainless steel
- 18/8 steels with service temperatures down to -196°C (-320°F)

DIAMETERS / PACKAGING

Diameter in (mm)	55 lb (25 kg) Steel Spool
5/64 (2.0)	ED034914
3/32 (2.4)	ED034915
1/8 (3.2)	ED034916
5/32 (3.9)	ED035968

MECHANICAL PROPERTIES⁽¹⁾

	Yield Strength ⁽²⁾ MPa (ksi)	Tensile Strength MPa (ksi)	Elongation %	Charpy V-Notch J (ft-lbf) -196°C (-320°F)	Lateral Expansion mils (mm) -196°C (-320°F)
Typical Results⁽³⁾ As-Welded with Lincolnweld P2007	410 (59)	570 (82)	32	48 (36)	17 (0.43)

WIRE COMPOSITION⁽¹⁾ – As Required per AWS A5.9

	%C	%Cr	%Ni	%Mo	%Mn
Requirements AWS ER308/308L	0.03 max	19.5-22.0	9.0-11.0	0.75 max	1.0-2
Typical Results⁽³⁾	0.03	19.9	10.8	0.12	1.8
	%Si	%P	%S	%Cu	FN
Requirements AWS ER308/308L	0.30-0.65	0.03 max	0.03 max	0.75 max	Not required
Typical Results⁽³⁾	0.35	0.02	0.01	0.14	3-8

⁽¹⁾Typical all weld metal ⁽²⁾Measured with 0.2% offset ⁽³⁾See test results disclaimer

IMPORTANT: SPECIAL VENTILATION AND/OR EXHAUST REQUIRED

Fumes from the normal use of some welding products can contain significant quantities of components - such as chromium and manganese - which can lower the 5.0 mg/m³ maximum exposure guideline for general welding fume. BEFORE USE, READ AND UNDERSTAND THE SAFETY DATA SHEET (SDS) FOR THIS PRODUCT AND SPECIFIC INFORMATION PRINTED ON THE PRODUCT CONTAINER.

LINCOLNWELD® 309LMo_MOD

Stainless

KEY FEATURES

- Similar to 309 with the exception of the addition of 2.0 - 3.0% molybdenum to increase its pitting corrosion resistance in halide-containing environments
- For surfacing of base metals to improve their resistance to corrosion
- Used to achieve a single-layer overlay with a chemical composition similar to that of a 316L stainless steel
- Q2 Lot® - Certificates showing actual wire chemistry available online

CONFORMANCES

AWS A5.9: ER309LMo

ISO 14343: 23 12 2 L

TYPICAL APPLICATIONS

- Used for the first layer of multilayer overlays with filler metals such as 316L or 317L stainless steel

RECOMMENDED FLUXES

P2007, P2000

DIAMETERS / PACKAGING

Diameter in (mm)	55 lb (25 kg) Steel Spool
3/32 (2.4)	ED035171

WIRE COMPOSITION⁽¹⁾ – As Required per AWS A5.9

	%C	%Cr	%Ni	%Mo	%Mn
Requirements AWS ER309LMo	0.03 max	21.0 - 21.8	14.2 - 15.3	2.0 - 3.0	1.0 - 2.5
Typical Results⁽²⁾	0.01	22.3	15.0	2.6	1.40
	%Si	%P	%S	%Cu	FN
Requirements AWS ER309LMo	0.30 - 0.65	0.03 max	0.03 max	0.75 max	Not Required
Typical Results⁽²⁾	0.40	0.02	0.01	0.10	6 - 12

TYPICAL OPERATING PROCEDURES

Diameter in (mm)	Voltage (volts)	Amperage
3/32 (2.4)	28-33	275-350

⁽¹⁾Typical all weld metal. ⁽²⁾See test results disclaimer

IMPORTANT: SPECIAL VENTILATION AND/OR EXHAUST REQUIRED

Fumes from the normal use of some welding products can contain significant quantities of components - such as chromium and manganese - which can lower the 5.0 mg/m³ maximum exposure guideline for general welding fume. BEFORE USE, READ AND UNDERSTAND THE SAFETY DATA SHEET (SDS) FOR THIS PRODUCT AND SPECIFIC INFORMATION PRINTED ON THE PRODUCT CONTAINER.

LINCOLNWELD® 309/309L

Stainless · AWS ER309, ER309L

KEY FEATURES

- Designed to be used primarily with basic fluxes that recover nearly all of the wire chromium in the deposit
- Low carbon content recommended where there is a risk of intergranular corrosion
- Reduced carbon levels (0.03% max) that offers increased resistance to inter-granular corrosion
- Q2 Lot® - Certificate showing actual wire composition and calculated ferrite number (FN) available online

RECOMMENDED FLUXES

Lincolnweld® 801, 802, 880, 880M, 882, P2000, P2007, ST-100

CONFORMANCES

AWS A5.9:	ER309, ER309L
ASME SFA-5.9:	ER309, ER309L
CWB/CSA:	ER309, ER309L
ISO 14343-B:	SS309L
ABS:	ER309, ER309L

TYPICAL APPLICATIONS

- ASTM A743, A744 Types CF-8 and CF-3 and ASTM A240 Type 309S
- For joining carbon or mild alloy steel to austenitic stainless steels
- Can also be used on "18-8" steels, since it overmatches the corrosion resistance, if the weldment will not be exposed to temperatures of 538° C to 927° C (1000° F to 1700° F)
- Ideal for joining stainless steels to themselves or to carbon or low alloy steels, and can be used at temperatures up to 700° F (371° C)

DIAMETERS / PACKAGING

Diameter in (mm)	55 lb (25 kg) Steel Spool	500 lb (227 kg) Speed Feed® Drum
5/64 (2.0)	ED033151	
3/32 (2.4)	ED035168	ED036448
1/8 (3.2)	ED035169	ED036449
5/32 (4.0)	ED035170	ED036450

MECHANICAL PROPERTIES⁽¹⁾ – As Required per AWS A5.9

	Yield Strength ⁽²⁾ MPa (ksi)	Tensile Strength MPa (ksi)	Elongation %	Ferrite Number
Test Results ^(3,5) - As-Welded with Lincolnweld P2007	400 (58)	575 (83)	35	8

⁽¹⁾Typical all weld metal. ⁽²⁾Measured with 0.2% offset. ⁽³⁾See test results disclaimer. ⁽⁴⁾AWS Requirement for ER309 is 0.08% max. carbon.

⁽⁵⁾Results shown correspond with the recommended Lincolnweld® fluxes listed above, but not required per AWS A5.9-12.

WIRE COMPOSITION⁽¹⁾ – As Required per AWS A5.9

	%C ⁽⁴⁾	%Cr	%Ni	%Mo	%Mn	%Si
Requirements - AWS ER309, ER309L	0.03 max	23.0 - 25.0	12.0 - 14.0	0.75 max	1.0 - 2.5	0.30 - 0.65
Typical Results⁽²⁾						
Wire Composition	0.02	23.9	13.0	0.15	1.8	0.50
All Weld Metal Composition ⁽³⁾	0.03	23.1 - 23.6	13.0	0.15	1.5 - 2.0	0.50 - 0.80

TYPICAL OPERATING PROCEDURES

Diameter - in (mm)	Wire Feed Speed - in/min (m/min)	Voltage (volts)	Current (amps)
5/64 (2.0)	80-240 (2.0-6.1)	24-30	190-500
3/32 (2.4)	60-210 (1.5-5.3)	26-32	195-575
1/8 (3.2)	35-110 (0.9-2.8)	28-34	200-700
5/32 (4.0)	30-75 (0.8-1.9)	30-36	320-775

⁽¹⁾Typical all weld metal. ⁽²⁾Measured with 0.2% offset. ⁽³⁾See test results disclaimer ⁽⁴⁾AWS Requirement for ER309 is 0.08% max. carbon.

⁽⁵⁾Results shown correspond with the recommended Lincolnweld® fluxes listed above, but not required per AWS A5.9-12.

IMPORTANT: SPECIAL VENTILATION AND/OR EXHAUST REQUIRED

Fumes from the normal use of some welding products can contain significant quantities of components - such as chromium and manganese - which can lower the 5.0 mg/m³ maximum exposure guideline for general welding fume.
BEFORE USE, READ AND UNDERSTAND THE SAFETY DATA SHEET (SDS) FOR THIS PRODUCT AND SPECIFIC INFORMATION PRINTED ON THE PRODUCT CONTAINER.

LINCOLNWELD® 310

Stainless · AWS ER310

KEY FEATURES

- Austenitic stainless for high temperatures and heat resistant applications
- Used for welding stainless steels of similar composition in cast and wrought forms
- The weld deposit is fully austenitic, low heat inputs required to prevent cracking
- Q2 Lot® - Certificates showing actual wire chemistry available online

RECOMMENDED FLUXES

P2007, P2000

CONFORMANCES

AWS A5:	ER310
ASME SFA-5.9:	ER310
CWB/CSA:	ER310
ABS:	ER310

TYPICAL APPLICATIONS

- Head shields
- Furnace parts
- Ducting

DIAMETERS / PACKAGING

Diameter in (mm)	55 lb (25 kg) Steel Spool
1/16 (1.6)	ED035172
3/32 (2.4)	ED035173

WIRE COMPOSITION⁽¹⁾ – As Required per AWS A5.9

	%C	%Cr	%Ni	%Mo	%Mn
Requirements AWS ER310	0.08 - 0.15	25.0 - 28.0	20.0 - 22.5	0.75 max	1.0 - 2.5
Typical Results⁽²⁾	0.11	27.1	21.0		1.90
	%Si	%P	%S	%Cu	FN
Requirements AWS ER310	0.30 - 0.65	0.03 max	0.03 max	0.75 max	Not Required
Typical Results⁽²⁾	0.40	0.01	0.003	0.04	

TYPICAL OPERATING PROCEDURES

Diameter in (mm)	Voltage (volts)	Amperage	Flux
1/16 (1.6) 3/32 (2.4)	28-33	275-350	Lincolnweld® P2007

⁽¹⁾Typical all weld metal. ⁽²⁾See test results disclaimer

IMPORTANT: SPECIAL VENTILATION AND/OR EXHAUST REQUIRED

Fumes from the normal use of some welding products can contain significant quantities of components - such as chromium and manganese - which can lower the 5.0 mg/m³ maximum exposure guideline for general welding fume. BEFORE USE, READ AND UNDERSTAND THE SAFETY DATA SHEET (SDS) FOR THIS PRODUCT AND SPECIFIC INFORMATION PRINTED ON THE PRODUCT CONTAINER.

LINCOLNWELD® 316/316LCF

Stainless · AWS ER316/316L

KEY FEATURES

- Controlled Low Ferrite (Range 3-5)
- Charpy V-Notch test results capable of exceeding 27 J (20 ft-lbf) @ -196°C (-320°F)
- Exceeds 15 mils (0.38 mm) of lateral expansion @ -196°C (-320°F)
- Batch Managed Inventory
- Q2 Lot® - Certificate showing deposit composition, ferrite number, and charpy impact properties tested at -196C(-320F)

RECOMMENDED FLUX

Lincolnweld® P2007

CONFORMANCES

- AWS A5.9:** ER316, ER316L
ASME SFA-5.9: ER316, ER316L
ABS: ER316, ER316L

TYPICAL APPLICATIONS

- LNG Storage
- Cryogenic Vessels and Piping

TYPICAL BASE METALS

316L stainless steels

DIAMETERS / PACKAGING

Diameter in (mm)	55 lb (25 kg) Steel Spool
5/64 (2.0)	ED034930
3/32 (2.4)	ED034931
1/8 (3.2)	ED034932

MECHANICAL PROPERTIES^(a) – As Required per AWS A5.9

	Yield Strength ^(b) MPa (ksi)	Tensile Strength MPa (ksi)	Elongation %	Charpy V-Notch J (ft-lbf) -196°C (-320°F)	Lateral Expansion mils (mm) -196°C (-320°F)
Typical Results^(b) As-Welded with Lincolnweld P2007	420 (61)	610 (89)	43	53 (39)	20 (0.51)

^(a)Typical all weld metal ^(b)Measured with 0.2% offset ^(c)See test results disclaimer

IMPORTANT: SPECIAL VENTILATION AND/OR EXHAUST REQUIRED

Fumes from the normal use of some welding products can contain significant quantities of components - such as chromium and manganese - which can lower the 5.0 mg/m³ maximum exposure guideline for general welding fume. BEFORE USE, READ AND UNDERSTAND THE SAFETY DATA SHEET (SDS) FOR THIS PRODUCT AND SPECIFIC INFORMATION PRINTED ON THE PRODUCT CONTAINER.

LINCOLNWELD® 316/316L

Stainless · AWS ER316, ER316L

KEY FEATURES

- Designed to be used primarily with basic fluxes that recover nearly all of the wire chromium in the deposit
- Low carbon content recommended where there is a risk of intergranular corrosion
- The 2-3% molybdenum improves pitting corrosion resistance of the weld deposit
- Low carbon content reduces the possibility of carbide precipitation and intergranular corrosion
- Q2 Lot® - Certificate showing actual wire composition and calculated ferrite number [FN] available online

RECOMMENDED FLUXES

Lincolnweld® 801, 802, 880, 880M, 882, P2007, ST-100

CONFORMANCES

AWS A5.9:	ER316, ER316L
ASME SFA-5.9:	ER316, ER316L
CWB/CSA:	ER316, ER316L
ISO 14343-B:	SS316L
ABS:	ER316, ER316L

TYPICAL APPLICATIONS

- ASTM A743, A744 Types CF-8 and CF-3
- Developed for welding type 316 and 316L stainless steels
- For joining the more common austenitic stainless steel grades referred to as "18-8" steels
- For very good corrosion resistance in acid environments
- Power Generation
- Chemical and Petrochemical Processing

DIAMETERS / PACKAGING

Diameter in (mm)	55 lb (25 kg) Steel Spool	500 lb (227 kg) Speed Feed® Drum	750 lb (340 kg) Speed Feed® Drum	600 lb (272 kg) Speed Feed® Reel
1/16 (1.6)	ED035180	ED036429		
5/64 (2.0)	ED035174			
3/32 (2.4)	ED035177	ED036452	ED036603	ED034479
1/8 (3.2)	ED035178	ED036453	ED036605	
5/32 (4.0)	ED035179	ED036454		

MECHANICAL PROPERTIES⁽¹⁾ – As Required per AWS A5.9

	Yield Strength ⁽²⁾ MPa (ksi)	Tensile Strength MPa (ksi)	Elongation %	Ferrite Number
Test Results ^(3, 5) - As-Welded with Lincolnweld P2007	380 (55)	550 (80)	42	9

⁽¹⁾Typical all weld metal. ⁽²⁾Measured with 0.2% offset. ⁽³⁾See test results disclaimer ⁽⁴⁾AWS Requirement for ER316 is 0.08% max. carbon.

⁽⁵⁾Results shown correspond with the recommended Lincolnweld® and Blue Max® fluxes listed above, but not required per AWS A5.9-93.

WIRE COMPOSITION⁽¹⁾ – As Required per AWS A5.9

	%C ⁽⁴⁾	%Cr	%Ni	%Mo	%Mn	%Si
Requirements - AWS ER316, ER316L	0.03 max	18.0 - 20.0	11.0 - 14.0	2.0 - 3.0	1.0 - 2.5	0.30 - 0.65
Typical Results⁽²⁾						
As-Welded	0.02	19.0	11.9	2.2	1.8	0.50
All Weld Metal Composition ⁽³⁾	0.02	17.8 - 18.4	11.9	2.2	1.6 - 2.0	0.50 - 0.80

TYPICAL OPERATING PROCEDURES

Diameter - in (mm)	Wire Feed Speed - m/min (in/min)	Voltage (volts)	Current (amps)
5/64 [2.0]	2.0-6.1 [80-240]	24-30	190-500
3/32 [2.4]	1.5-5.3 [60-210]	26-32	195-575
1/8 [3.2]	0.9-2.8 [35-110]	28-34	200-700
5/32 [4.0]	0.8-1.9 [30-75]	30-36	320-775

⁽¹⁾Typical all weld metal. ⁽²⁾Measured with 0.2% offset. ⁽³⁾See test results disclaimer ⁽⁴⁾AWS Requirement for ER316 is 0.08% max. carbon.

⁽⁵⁾Results shown correspond with the recommended Lincolnweld® and Blue Max® fluxes listed above, but not required per AWS A5.9-93.

IMPORTANT: SPECIAL VENTILATION AND/OR EXHAUST REQUIRED

Fumes from the normal use of some welding products can contain significant quantities of components - such as chromium and manganese - which can lower the 5.0 mg/m³ maximum exposure guideline for general welding fume. BEFORE USE, READ AND UNDERSTAND THE SAFETY DATA SHEET (SDS) FOR THIS PRODUCT AND SPECIFIC INFORMATION PRINTED ON THE PRODUCT CONTAINER.

LINCOLNWELD® 317/317L

Stainless · AWS ER317L

KEY FEATURES

- Weld deposit similar to 316L with a high molybdenum content for increased corrosion resistance
- Used for welding alloys with similar composition in high corrosive environments
- Q2 Lot® - Certificates showing actual wire chemistry available online

CONFORMANCES

AWS A5.9:	ER317, ER317L
ASME SFA-5.9:	ER317, ER317L
CWB/CSA:	ER317, ER317L

TYPICAL APPLICATIONS

- Chemical Processing Plants
- Petrochemical
- Condensers
- Food Processing

RECOMMENDED FLUXES

P2007, P2000

DIAMETERS / PACKAGING

Diameter in (mm)	55 lb (25 kg) Steel Spool
3/32 (2.4)	ED035181
1/8 (3.2)	ED035182

WIRE COMPOSITION⁽¹⁾ – As Required per AWS A5.9

	%C	%Cr	%Ni	%Mo	%Mn
Requirements - AWS ER317L	0.03 max	18.5 - 20.5	13.0 - 15.0	3.0 - 4.0	1.0 - 2.5
Typical Results⁽²⁾	0.01	18.9	13.7	3.5	1.4
	%Si	%P	%S	%Cu	
Requirements - AWS ER317L	0.30 - 0.65	0.03 max	0.03 max	0.75 max	
Typical Results⁽²⁾	0.45	0.01	0.008	0.08	

TYPICAL OPERATING PROCEDURES

Diameter in (mm)	Voltage (volts)	Amperage
3/32 (2.4)	28-33	275-350
1/8 (3.2)	29-32	350-450

⁽¹⁾Typical all weld metal. ⁽²⁾See test results disclaimer

IMPORTANT: SPECIAL VENTILATION AND/OR EXHAUST REQUIRED

Fumes from the normal use of some welding products can contain significant quantities of components - such as chromium and manganese - which can lower the 5.0 mg/m³ maximum exposure guideline for general welding fume. BEFORE USE, READ AND UNDERSTAND THE SAFETY DATA SHEET (SDS) FOR THIS PRODUCT AND SPECIFIC INFORMATION PRINTED ON THE PRODUCT CONTAINER.

LINCOLNWELD® 320LR

Stainless · AWS ER320LR

KEY FEATURES

- LR contains low residual elements for better resistance to hot cracking
- Excellent corrosion resistance in highly acidic environments
- Q2 Lot® - Certificates showing actual wire chemistry available online

RECOMMENDED FLUXES

P2007, P2000

CONFORMANCES

AWS A5.9:	ER320LR
ASME SFA-5.9:	ER320LR
CWB/CSA:	ER320LR

TYPICAL APPLICATIONS

- Tanks
- Process Piping
- Heat Exchangers
- Typically used for welding base metals with similar compositions including alloy 20

DIAMETERS / PACKAGING

Diameter in (mm)	55 lb (25 kg) Steel Spool
3/32 (2.4)	ED035183

WIRE COMPOSITION⁽¹⁾ – As Required per AWS A5.9

	%C	%Cr	%Ni	%Mo	%Mn
Requirements AWS ER320LR	0.025 max	19.0 - 21.0	32.0 - 36.0	2.0 - 3.0	1.5 - 2.0
Typical Results⁽²⁾	0.003	20.1	33.3	2.4	1.7
	%Si	%P	%S	%Cu	%Nb
Requirements AWS ER320LR	0.15 max	0.015 max	0.02 max	3.0 - 4.0	Required 8 x C / 1.0 max
Typical Results⁽²⁾	0.01	0.010	0.001	3.3	0.22

TYPICAL OPERATING PROCEDURES

Diameter in (mm)	Voltage (volts)	Amperage
3/32 (2.4)	29-32	350-450

⁽¹⁾Typical all weld metal. ⁽²⁾See test results disclaimer

IMPORTANT: SPECIAL VENTILATION AND/OR EXHAUST REQUIRED

Fumes from the normal use of some welding products can contain significant quantities of components - such as chromium and manganese - which can lower the 5.0 mg/m³ maximum exposure guideline for general welding fume. BEFORE USE, READ AND UNDERSTAND THE SAFETY DATA SHEET (SDS) FOR THIS PRODUCT AND SPECIFIC INFORMATION PRINTED ON THE PRODUCT CONTAINER.

LINCOLNWELD® 347

Stainless · AWS ER347

KEY FEATURES

- The addition of niobium reduces intergranular corrosion in severe operating conditions
- Q2 Lot® - Certificates showing actual wire chemistry available online

RECOMMENDED FLUXES

P2000
OP F500 flux

CONFORMANCES

AWS A5.9:	ER347
ASME SFA-5.9:	ER347
CWB/CSA:	ER347
ABS:	ER347

TYPICAL APPLICATIONS

- Food Processing
- Pharmaceutical Equipment
- Niobium stabilized stainless steel electrodes used for the welding of types 347 and 321 stainless and stainless clad steels

DIAMETERS / PACKAGING

Diameter in (mm)	55 lb (25 kg) Steel Spool	500 lb (227 kg) Speed Feed® Reel
3/32 (2.4)	ED035185	ED035184
1/8 (3.2)	ED035186	

WIRE COMPOSITION⁽¹⁾ – As Required per AWS A5.9

	%C	%Cr	%Ni	%Mo	%Nb + Ta
Requirements AWS ER347	0.08 max	19.0 - 21.5	9.0 - 11.0	0.75 max	10 x C - 1.0
Typical Results⁽²⁾	0.03	19.5	9.3	0.25	0.60
	%Mn	%Si	%P	%S	%Cu
Requirements AWS ER347	1.0 - 2.5	0.30 - 0.65	0.03 max	0.03 max	0.75 max
Typical Results⁽²⁾	1.7	0.45	0.01	0.007	0.10

TYPICAL OPERATING PROCEDURES

Diameter in (mm)	Voltage (volts)	Amperage
3/32 (2.4)	28-33	275-350
1/8 (3.2)	29-32	350-450

⁽¹⁾Typical all weld metal. ⁽²⁾See test results disclaimer

IMPORTANT: SPECIAL VENTILATION AND/OR EXHAUST REQUIRED

Fumes from the normal use of some welding products can contain significant quantities of components - such as chromium and manganese - which can lower the 5.0 mg/m³ maximum exposure guideline for general welding fume. BEFORE USE, READ AND UNDERSTAND THE SAFETY DATA SHEET (SDS) FOR THIS PRODUCT AND SPECIFIC INFORMATION PRINTED ON THE PRODUCT CONTAINER.

LINCOLNWELD® 385

Stainless · AWS ER385

KEY FEATURES

- Weld metal is fully austenitic and must be done with low heat input using a stringer bead technique
- Q2 Lot® - Certificates showing actual wire chemistry available online

RECOMMENDED FLUXES

P2000, P2007

CONFORMANCES

AWS A5: ER385
ASME SFA-5.9: ER385

TYPICAL APPLICATIONS

- Welding 904L Stainless Steel
- Sulfuric and Phosphoric Acid Storage Vessels

DIAMETERS / PACKAGING

Diameter in (mm)	55 lb (25 kg) Steel Spool
3/32 (2.4)	ED035187

WIRE COMPOSITION⁽¹⁾ – As Required per AWS A5.9

	%C	%Cr	%Ni	%Mo	%Mn
Requirements AWS ER385	0.025 max	19.5 - 21.5	24.0 - 26.0	4.2 - 5.2	1.0 - 2.5
Typical Results⁽²⁾ Lincolnweld® 385	0.010	19.9	25.0	4.2	1.8
	%Si	%P	%S	%Cu	
Requirements AWS ER385	0.50 max	0.02 max	0.03 max	1.2 - 2.0	
Typical Results⁽²⁾ Lincolnweld® 385	0.3	0.01	0.001	1.4	

TYPICAL OPERATING PROCEDURES

Diameter in (mm)	Voltage (volts)	Amperage
3/32 (2.4)	28-33	275-350

⁽¹⁾Typical all weld metal. ⁽²⁾See test results disclaimer

IMPORTANT: SPECIAL VENTILATION AND/OR EXHAUST REQUIRED

Fumes from the normal use of some welding products can contain significant quantities of components - such as chromium and manganese - which can lower the 5.0 mg/m³ maximum exposure guideline for general welding fume. BEFORE USE, READ AND UNDERSTAND THE SAFETY DATA SHEET (SDS) FOR THIS PRODUCT AND SPECIFIC INFORMATION PRINTED ON THE PRODUCT CONTAINER.

LINCOLNWELD® 410NiMo

Stainless · AWS ER410NiMo

KEY FEATURES

- Used to overlay mild and low alloy steels
- Preheat and inter-pass temperatures of 300°F (150°C) or greater are recommended during welding
- Post-weld heat treatment should not exceed 1150°F (620° C) as higher temperatures may result in hardening
- Q2 Lot* - Certificates showing actual wire chemistry available online

RECOMMENDED FLUXES

P2007, P2000

CONFORMANCES

AWS A5: ER410NiMo
ASME SFA-5.9: ER410NiMo

TYPICAL APPLICATIONS

- Turbines
- Valve Bodies
- High Pressure Piping
- Offshore
- Power Generation
- High Pressure Piping
- Designed to weld materials of similar chemical composition in cast and wrought forms
- CA6NM Material

DIAMETERS / PACKAGING

Diameter in (mm)	55 lb (25 kg) Steel Spool
3/32 2.3	ED036500
1/8 (3.2)	ED035188

WIRE COMPOSITION⁽¹⁾ – As Required per AWS A5.9

	%C	%Cr	%Ni	%Mo	%Mn
Requirements AWS ER410NiMo	0.06 max	11.0 - 12.5	4.0 - 5.0	0.4 - 0.7	0.6 max
Typical Results⁽²⁾	0.02	11.7	4.7	0.5	0.2
	%Si	%P	%S	%Cu	
Requirements AWS ER410NiMo	0.5 max	0.03 max	0.03 max	0.75 max	
Typical Results⁽²⁾	0.2	0.01	0.002	0.06	

TYPICAL OPERATING PROCEDURES

Diameter in (mm)	Voltage (volts)	Amperage
1/8 (3.2)	29-32	350-450

⁽¹⁾Typical all weld metal. ⁽²⁾See test results disclaimer

IMPORTANT: SPECIAL VENTILATION AND/OR EXHAUST REQUIRED

Fumes from the normal use of some welding products can contain significant quantities of components - such as chromium and manganese - which can lower the 5.0 mg/m³ maximum exposure guideline for general welding fume. BEFORE USE, READ AND UNDERSTAND THE SAFETY DATA SHEET (SDS) FOR THIS PRODUCT AND SPECIFIC INFORMATION PRINTED ON THE PRODUCT CONTAINER.

LINCOLNWELD® 630

Stainless · AWS ER630

KEY FEATURES

- Precipitation hardening martensitic stainless steel covered electrode used for welding materials of similar chemical composition such as 17-4 and 17-7
- Can be used in the as welded condition or may be heat treated to obtain higher strength
- Mechanical properties of the alloy are greatly influenced by the heat treatment
- Q2 Lot® - Certificates showing actual wire chemistry available online

RECOMMENDED FLUXES

P2007, P2000

CONFORMANCES

AWS A5.9: ER630
 ASME SFA-5.9: ER630
 CWB/CSA: ER630

TYPICAL APPLICATIONS

- Hydraulic Equipment Components
- Impellers
- Pump Shafts
- 17-4 PH Stainless Steel

DIAMETERS / PACKAGING

Diameter in (mm)	500 lb [227 kg] Speed-Feed® Reel
3/32 [2.4]	ED035189

WIRE COMPOSITION⁽¹⁾ – As Required per AWS A5.9

	%C	%Cr	%Ni	%Mo	%Nb
Requirements AWS ER630	0.05 max	16.00 - 16.75	4.5 - 5.0	0.75 max	0.15 - 0.30
Typical Results⁽²⁾ Lincolnweld® 630	0.03	16.5	4.8	0.2	0.22
	%Mn	%Si	%P	%S	%Cu
Requirements AWS ER630	0.25 - 0.75	0.75 max	0.03 max	0.03 max	3.25 - 4.0
Typical Results⁽³⁾ Lincolnweld® 630	0.54	0.43	0.02	0.02	3.6

TYPICAL OPERATING PROCEDURES

Diameter in (mm)	Voltage (volts)	Amperage
3/32 [2.4]	28-33	275-350

⁽¹⁾Typical all weld metal. ⁽²⁾See test results disclaimer

IMPORTANT: SPECIAL VENTILATION AND/OR EXHAUST REQUIRED

Fumes from the normal use of some welding products can contain significant quantities of components - such as chromium and manganese - which can lower the 5.0 mg/m³ maximum exposure guideline for general welding fume. BEFORE USE, READ AND UNDERSTAND THE SAFETY DATA SHEET (SDS) FOR THIS PRODUCT AND SPECIFIC INFORMATION PRINTED ON THE PRODUCT CONTAINER.

LINCOLNWELD® 2209

Stainless · AWS ER2209

KEY FEATURES

- The welds offer excellent resistance to stress corrosion, cracking and pitting
- The microstructure of the weld metal consists of austenite and ferrite
- The ferrite content of the weld metal will be lower than the ferrite content of type 2205 base metal
- Q2 Lot® - Certificates showing actual wire chemistry available online

CONFORMANCES

AWS A5.9:	ER2209
ABS:	ER2209
CWB/CSA:	ER2209

TYPICAL APPLICATIONS

- Offshore
- Oil and Gas
- Chemical
- Petrochemical
- Used to weld duplex stainless steels such as (Type 2205)

RECOMMENDED FLUXES

P2000

DIAMETERS / PACKAGING

Diameter in (mm)	55 lb (25 kg) Steel Spool
3/32 (2.4)	ED035154
1/8 (3.2)	ED035155

WIRE COMPOSITION⁽¹⁾ – As Required per AWS A5.9

	%C	%Cr	%Ni	%Mo	%Mn	%Si
Requirements AWS ER2209	0.03 max	21.5 - 23.5	7.5 - 9.5	2.5 - 3.5	0.5 - 2.0	0.90 max
Typical Results⁽²⁾	0.01	22.7	8.5	3.0	1.4	0.4
	%P	%S	%N	%Cu	FN	
Requirements AWS ER2209	0.03 max	0.03 max	0.08 - 0.20	0.75 max	Not Required	
Typical Results⁽²⁾	0.01	0.001	0.15	0.06	30 - 60	

TYPICAL OPERATING PROCEDURES

Diameter in (mm)	Voltage (volts)	Amperage
3/32 (2.4)	28-33	275-350
1/8 (3.2)	29-32	350-450

⁽¹⁾Typical all weld metal. ⁽²⁾See test results disclaimer

IMPORTANT: SPECIAL VENTILATION AND/OR EXHAUST REQUIRED

Fumes from the normal use of some welding products can contain significant quantities of components - such as chromium and manganese - which can lower the 5.0 mg/m³ maximum exposure guideline for general welding fume. BEFORE USE, READ AND UNDERSTAND THE SAFETY DATA SHEET (SDS) FOR THIS PRODUCT AND SPECIFIC INFORMATION PRINTED ON THE PRODUCT CONTAINER.

LINCOLNWELD® 2594

Stainless · AWS ER2594

KEY FEATURES

- A super-duplex grade electrode that provides matching chemistry and mechanical property characteristics to wrought super-duplex alloys such as 2507 and Zeron 100, as well as to super-duplex casting alloys (ATSM A890)
- The electrode is over-alloyed with nitrogen to provide the optimum ferrite/austenite ratio in the finished weld resulting in high tensile and yield strength and superior resistance to stress corrosion, cracking (SCC) and pitting corrosion
- Q2 Lot® - Certificates showing actual wire chemistry available online

CONFORMANCES

AWS A5.9:	ER2594
ASME SFA-5.9:	ER2594
CWB/CSA:	ER2594
ABS:	ER2594

TYPICAL APPLICATIONS

- Process Pipework
- Pumps and Valves
- Pressure Vessels
- 2507
- Zeron 100

RECOMMENDED FLUXES

P2000

DIAMETERS / PACKAGING

Diameter in (mm)	55 lb (25 kg) Steel Spool
3/32 (2.4)	ED035156
1/8 (3.2)	ED035157

WIRE COMPOSITION⁽¹⁾ – As Required per AWS A5.9

	%C	%Cr	%Ni	%Mo	%Mn	%Si
Requirements AWS ER2594	0.03 max	24.0 - 27.0	8.0 - 10.5	2.5 - 4.5	2.5 max	1.0 max
Typical Results⁽²⁾	0.02	24.6	8.6	3.8	0.8	0.3
	%P	%S	%N	%Cu	%W	FN
Requirements AWS ER2594	0.03 max	0.02 max	0.20 - 0.30	1.5 max	1.00 max	Not Required
Typical Results⁽²⁾	0.02	0.01	0.25	0.01	0.01	30 - 60

TYPICAL OPERATING PROCEDURES

Diameter in (mm)	Voltage (volts)	Amperage
3/32 (2.4)	28-33	275-350
1/8 (3.2)	29-32	350-450

⁽¹⁾Typical all weld metal. ⁽²⁾See test results disclaimer

IMPORTANT: SPECIAL VENTILATION AND/OR EXHAUST REQUIRED

Fumes from the normal use of some welding products can contain significant quantities of components - such as chromium and manganese - which can lower the 5.0 mg/m³ maximum exposure guideline for general welding fume. BEFORE USE, READ AND UNDERSTAND THE SAFETY DATA SHEET (SDS) FOR THIS PRODUCT AND SPECIFIC INFORMATION PRINTED ON THE PRODUCT CONTAINER.

ER16.8.2

Stainless · AWS ER16-8-2

KEY FEATURES

- Solid wire developed to weld 3XXH grades of stainless steel
- Designed with 0.04-0.10% carbon to create a creep, oxidation, and corrosion resistant weld deposit
- Engineered with controlled carbon levels and ferrite content for high resistance to thermal embrittlement
- A lean composition and controlled ferrite content provides useful cryogenic toughness down to -196°C (-321°F)

RECOMMENDED FLUXES

P2000, P2007

CONFORMANCES

AWS A5.9	ER16-8-2
BS EN ISO 14343-A	16 8 2
BS EN ISO 14343-B	SS16-8-2

TYPICAL APPLICATIONS

- Gas & Steam Turbines
- Petrochemical & Chemical Industries
- Power Generation Industry
- Steam Piping
- Catalytic Crackers

DIAMETERS / PACKAGING

Diameter mm [in]	25 kg (55.1 lb) Coil
2.4 (3/32)	SAER1682-24

MECHANICAL PROPERTIES⁽¹⁾ – As Required per AWS A5.9

	Yield Strength ⁽²⁾ MPa (ksi)	Tensile Strength MPa (ksi)	Elongation %	Charpy V-Notch J (ft-lbf) @-196°C (-321°F)
Requirements AWS ER16-8-2	-	-	-	-
Typical Results⁽³⁾ As-Welded with Lincolnweld P2007	360 [52]	630 [91]	29 min	30

DEPOSIT COMPOSITION⁽¹⁾ – As Required per AWS A5.9

	%C	%Mn	%Si	%S	%P
Requirements AWS ER16-8-2	0.04-0.10	1.0-2.0	0.3-0.6	0.02 max	0.03 max
Typical Results⁽³⁾	0.06	1.4	0.4	0.01	0.01
	%Cr	%Ni	%Mo	%Cu	
Requirements AWS ER16-8-2	14.5-16.5	7.5-9.5	1.0-2.0	0.3 max	
Typical Results⁽³⁾	15.5	8.5	1.3	0.1	

TYPICAL OPERATING PROCEDURES

Diameter mm [in]	Amperage	Voltage
2.4 (3/32)	350A	30V

⁽¹⁾ Typical all weld metal ⁽²⁾ Measured with 0.2% offset ⁽³⁾ See test results disclaimer

IMPORTANT: SPECIAL VENTILATION AND/OR EXHAUST REQUIRED

Fumes from the normal use of some welding products can contain significant quantities of components - such as chromium and manganese - which can lower the 5.0 mg/m³ maximum exposure guideline for general welding fume. BEFORE USE, READ AND UNDERSTAND THE SAFETY DATA SHEET (SDS) FOR THIS PRODUCT AND SPECIFIC INFORMATION PRINTED ON THE PRODUCT CONTAINER.

LINCOLNWELD® P2000™

Stainless & Nickel · ENISO 760 – S A AF 2

KEY FEATURES

- Neutral basic flux designed for welding stainless steel and nickel alloys
- Produces sound welds with excellent slag removal and bead appearance including Nb bearing electrodes such as 347, 625, 606
- Exhibits superior resistance to moisture pickup
- Nickel overlays applications
- Stainless overlay and joining applications

CONFORMANCES

ISO 14174: S A AF 2

TYPICAL APPLICATIONS

- For submerged arc welding of stainless steel and nickel alloys

DIAMETERS / PACKAGING

50 lb (22.7 kg)
Plastic Bag

ED034290

DEPOSIT COMPOSITION⁽¹⁾

	%C	%Mn	%Si	%Cr	%Ni	%Mo	%P	%S
Lincolnweld® P2000™⁽²⁾								
With Lincolnweld® 308/308L	0.018	1.24	0.631	19.34	9.86	0.04	0.03	0.007
With Lincolnweld® 309/309L	0.014	1.23	0.569	23.18	13.27	0.11	0.02	0.007
With Lincolnweld® 316/316L	0.014	1.30	0.568	18.25	12.00	2.69	0.015	0.013

⁽¹⁾ Typical all weld metal. ⁽²⁾ See test results disclaimer. NOTE: There are not AWS requirements for submerged arc stainless steel deposits.

IMPORTANT: SPECIAL VENTILATION AND/OR EXHAUST REQUIRED

Fumes from the normal use of some welding products can contain significant quantities of components - such as chromium and manganese - which can lower the 5.0 mg/m³ maximum exposure guideline for general welding fume. BEFORE USE, READ AND UNDERSTAND THE SAFETY DATA SHEET (SDS) FOR THIS PRODUCT AND SPECIFIC INFORMATION PRINTED ON THE PRODUCT CONTAINER.

LINCOLNWELD® P2007™

Stainless & Nickel · ENISO 760 – S A AF 2

KEY FEATURES

- Neutral basic flux designed for welding stainless steel and nickel alloys
- Produces sound welds with excellent slag removal and bead appearance
- Exhibits superior resistance to moisture pickup
- Nickel overlays applications
- Stainless overlay and joining applications
- 2G girth welds with Ni alloys

CONFORMANCES

ISO 14174 : S A AAS 2

TYPICAL APPLICATIONS

- For submerged arc welding of the 300 and 400 series stainless steels, nickel alloys and similar alloy filler metal

DIAMETERS / PACKAGING

50 lb (22.7 kg)
Plastic Bag

ED033159

MECHANICAL PROPERTIES⁽¹⁾

	Yield Strength ⁽²⁾ MPa (ksi)	Tensile Strength MPa (ksi)	Elongation %	Ferrite Number
Lincolnweld® P2007⁽³⁾				
With Lincolnweld® 308/308L	380 (55)	565 (82)	40	7
With Lincolnweld® 309/309L	400 (58)	570 (83)	36	9
With Lincolnweld® 316/316L	380 (55)	550 (80)	43	9

DEPOSIT COMPOSITION⁽¹⁾

	%C	%Mn	%Si	%Cr	%Ni	%Mo	%P	%S
Lincolnweld® P2007⁽³⁾								
With Lincolnweld® 308/308L	0.02	1.52	0.63	18.83	9.67	0.13	0.02	0.01
With Lincolnweld® 309/309L	0.03	1.71	0.59	23.58	13.35	0.09	0.02	<0.01
With Lincolnweld® 316/316L	0.02	1.36	0.58	18.04	11.50	2.14	0.02	0.01

⁽¹⁾Typical all weld metal. ⁽²⁾Measured with 0.2% offset. ⁽³⁾See test results disclaimer

NOTE: There are no AWS requirements for submerged arc stainless steel deposits.

IMPORTANT: SPECIAL VENTILATION AND/OR EXHAUST REQUIRED

Fumes from the normal use of some welding products can contain significant quantities of components - such as chromium and manganese - which can lower the 5.0 mg/m³ maximum exposure guideline for general welding fume. BEFORE USE, READ AND UNDERSTAND THE SAFETY DATA SHEET (SDS) FOR THIS PRODUCT AND SPECIFIC INFORMATION PRINTED ON THE PRODUCT CONTAINER.

LINCOLNWELD® ST-100™

Stainless · ENISO 760 – S A AS 2

KEY FEATURES

- An alloy flux designed for use with solid stainless steel electrodes to compensate for chromium in the wire that is not recovered in the weld deposit
- Excellent slag removal characteristics
- Good performance on seamer applications

CONFORMANCES

ISO 14174: SA Z2

TYPICAL APPLICATIONS

- General submerged arc welding of common austenitic stainless steels such as 304, 304L, 316, 316L, 309 and 347

DIAMETERS / PACKAGING

50 lb (22.7 kg)
Plastic Bag

ED031856

MECHANICAL PROPERTIES⁽¹⁾

	Yield Strength ⁽²⁾ MPa (ksi)	Tensile Strength MPa (ksi)	Elongation %	Ferrite Number
Lincolnweld® ST-100⁽³⁾				
With Lincolnweld® 308/308L	405 (59)	600 (87)	38	10
With Lincolnweld® 309/309L	415 (60)	585 (85)	37	14
With Lincolnweld® 316/316L	415 (60)	585 (85)	40	10

DEPOSIT COMPOSITION⁽⁴⁾

	%C	%Mn	%Si	%Cr	%Ni	%Mo
Lincolnweld® ST-100^(3,4)						
With Lincolnweld® 308/308L Groove Weld	0.01 0.02	1.9 2.1	0.50 0.70	19.6 19.6	9.8 9.7	0.10 0.10
With Lincolnweld® 309/309L Groove Weld	0.02 0.03	2.1 2.3	0.40 0.60	23.8 24.1	13.7 13.6	0.10 0.10
With Lincolnweld® 316/316L Groove Weld	0.02 0.02	1.7 1.7	0.45 0.65	19.0 18.8	11.9 11.8	2.20 2.20

⁽¹⁾Typical all weld metal. ⁽²⁾Measured with 0.2% offset. ⁽³⁾See test results disclaimer. ⁽⁴⁾Results shown are typical wire compositions for the Lincolnweld® subarc wires listed, and typical weld deposit composition for 1 in groove welds on matching plate. NOTE: There are no AWS requirements for submerged arc stainless steel deposits.

IMPORTANT: SPECIAL VENTILATION AND/OR EXHAUST REQUIRED

Fumes from the normal use of some welding products can contain significant quantities of components - such as chromium and manganese - which can lower the 5.0 mg/m³ maximum exposure guideline for general welding fume. BEFORE USE, READ AND UNDERSTAND THE SAFETY DATA SHEET (SDS) FOR THIS PRODUCT AND SPECIFIC INFORMATION PRINTED ON THE PRODUCT CONTAINER.

LINCOLN® ER308/308H

Stainless · AWS ER308, ER308H

KEY FEATURES

- Provides a high carbon deposit (minimum of .04% carbon) for high temperature applications
- High carbon deposit provides creep strength and a high tensile strength at elevated temperatures
- Ink jet printing identification on entire length of electrode
- Q2 Lot® - Certificate showing actual wire composition and calculated ferrite number (FN) available online

WELDING POSITIONS

All

CONFORMANCES

AWS A5.9: ER308, ER308H

ASME SFA-5.9: ER308, ER308H

TYPICAL APPLICATIONS

- Chemical
- Petrochemical industries
- Distillery
- Dairy
- Restaurant Equipment
- Catalytic Crackers
- Pulp and Paper
- Used to weld unstabilized austenitic stainless steels such as 302, 304H and 305

SHIELDING GAS

100% Argon

DIAMETERS / PACKAGING

Diameter in (mm)	10 lb (4.5 kg) Tube 30 lb (13.6 kg) Master Carton
1/16 (1.6)	ED035199
3/32 (2.4)	ED035200
1/8 (3.2)	ED035201

WIRE COMPOSITION⁽¹⁾ – As Required per AWS A5.9

	%C	%Cr	%Ni	%Mo	%Mn
Requirements AWS ER308H	0.04 - 0.08	19.5 - 22.0	9.00 - 11.00	0.50 max	1.0 - 2.5
Typical Results⁽²⁾	0.06	19.9	9.7	0.07	1.8
	%Si	%P	%S	%Cu	FN
Requirements AWS ER308H	0.30 - 0.65	0.04 max	0.03 max	0.75 max	Not Required
Typical Results⁽²⁾	0.44	0.02	0.006	0.10	5 - 12

⁽¹⁾Typical wire composition. ⁽²⁾See test results disclaimer

IMPORTANT: SPECIAL VENTILATION AND/OR EXHAUST REQUIRED

Fumes from the normal use of some welding products can contain significant quantities of components - such as chromium and manganese - which can lower the 5.0 mg/m³ maximum exposure guideline for general welding fume. BEFORE USE, READ AND UNDERSTAND THE SAFETY DATA SHEET (SDS) FOR THIS PRODUCT AND SPECIFIC INFORMATION PRINTED ON THE PRODUCT CONTAINER.

LINCOLN® ER308/308L

Stainless · AWS ER308, ER308L

KEY FEATURES

- Balanced chromium and nickel levels provide enough ferrite in the weld for high resistance to hot cracking
- Dual classification ensures the maximum carbon content is 0.03%
- 0.03% carbon content increases resistance to intergranular corrosion
- Ink jet printing identification on entire length of electrode
- Q2 Lot® - Certificate showing actual wire composition and calculated ferrite number (FN) available online

WELDING POSITIONS

All

CONFORMANCES

- AWS A5.9:** ER308, ER308L
- ASME SFA-5.9:** ER308, ER308L
- CWB/CSA:** ER308, ER308L
- ISO 14343-B:** SS308L
- ABS:** ER308, ER308L

TYPICAL APPLICATIONS

- Sheet metal on the corresponding stainless steel base metals
- High pressure piping and tubing

SHIELDING GAS

100% Argon

DIAMETERS / PACKAGING

Diameter in (mm)	1 lb (0.5 kg) Plastic Tube 10 lb (4.5 kg) Master Carton	10 lb (4.5 kg) Plastic Tube 30 lb (13.6 kg) Master Carton
1/16 (1.6)	ED025410	ED034439
3/32 (2.4)	ED025413	ED034440
1/8 (3.2)	ED025416	ED034441
5/32 (4.0)		ED036060

WIRE COMPOSITION – As Required per AWS A5.9

	%C ^(a)	%Cr	%Ni	%Mo	%Mn
Requirements - AWS ER308L	0.03 max	19.5 - 22.0	9.0 -11.0	0.75 max	1.0 - 2.5
Typical Results ^(b)	0.02	20.2	9.2	0.03	1.6
	%Si	%P	%S	%Cu	Total Others
Requirements - AWS ER308L	0.30 - 0.65	0.03 max	0.03 max	0.75 max	0.50 max
Typical Results ^(b)	0.44	0.02	0.02	0.11	0.03

^(a)See test results disclaimer ^(b)Requirements for ER308 is 0.08% max. carbon.

IMPORTANT: SPECIAL VENTILATION AND/OR EXHAUST REQUIRED

Fumes from the normal use of some welding products can contain significant quantities of components - such as chromium and manganese - which can lower the 5.0 mg/m³ maximum exposure guideline for general welding fume. BEFORE USE, READ AND UNDERSTAND THE SAFETY DATA SHEET (SDS) FOR THIS PRODUCT AND SPECIFIC INFORMATION PRINTED ON THE PRODUCT CONTAINER.

LINCOLN® ER308/308LCF

Stainless · AWS ER308/308L

KEY FEATURES

- Controlled Low Ferrite (Range 3-6)
- Charpy V-Notch test results capable of exceeding 27 J (20 ft-lbf) @ -196°C (-320°F)
- Exceeds 15 mils (0.38 mm) of lateral expansion @ -196°C (-320°F)
- Batch Managed Inventory
- Ink jet printing identification on entire length of electrode
- Q2 Lot® - Certificates showing actual wire composition, ferrite number, and impact properties tested at -196°C (-320°F) available online

WELDING POSITIONS

All

CONFORMANCES

- AWS A5.9:** ER308, ER308L
ASME SFA-5.9: ER308, ER308L
ABS: ER308, ER308L

TYPICAL APPLICATIONS

- LNG Storage
- Cryogenic Vessels and Piping

SHIELDING GAS

100% Argon

TYPICAL BASE METALS

- 304L stainless steel
- 18/8 steels with service temperatures down to -196°C (-320°F)

DIAMETERS / PACKAGING

Diameter in (mm)	10 lb (4.5 kg) Tubes 30 lb (13.6 kg) Master Carton
1/16 (1.6)	ED034911
3/32 (2.4)	ED034912
1/8 (3.2)	ED034913

MECHANICAL PROPERTIES⁽¹⁾

	Yield Strength ⁽²⁾ MPa (ksi)	Tensile Strength MPa (ksi)	Elongation %	Charpy V-Notch J (ft-lbf) -196°C (-320°F)	Lateral Expansion mils (mm) -196°C (-320°F)
Typical Results⁽³⁾ As-Welded with 100% Ar	430 (62)	590 (86)	42	62 (84)	38 (0.97)

WIRE COMPOSITION⁽¹⁾ – As Required per AWS A5.9

	%C	%Cr	%Ni	%Mo	%Mn
Requirements - AWS ER308L	0.03 max	19.5 - 22.0	9.0 -11.0	0.75 max	1.0 - 2.5
Typical Results⁽³⁾	0.02	20.0	10.9	0.12	1.7
	%Si	%P	%S	%Cu	Total Others
Requirements - AWS ER308L	0.30 - 0.65	0.03 max	0.03 max	0.75 max	Not Required
Typical Results⁽³⁾	0.53	0.02	0.01	0.17	3-6

⁽¹⁾Typical all weld metal ⁽²⁾Measured with 0.2% offset ⁽³⁾See test results disclaimer

IMPORTANT: SPECIAL VENTILATION AND/OR EXHAUST REQUIRED

Fumes from the normal use of some welding products can contain significant quantities of components - such as chromium and manganese - which can lower the 5.0 mg/m³ maximum exposure guideline for general welding fume. BEFORE USE, READ AND UNDERSTAND THE SAFETY DATA SHEET (SDS) FOR THIS PRODUCT AND SPECIFIC INFORMATION PRINTED ON THE PRODUCT CONTAINER.

LINCOLN® ER308Si/308LSi

Stainless · AWS ER308Si, ER308LSi

KEY FEATURES

- High silicon level for increased puddle fluidity and wetting out at the toes
- Solid rod with lower carbon for welding Cr-Ni steels
- Used to primarily weld equipment made with 304 type stainless steel
- Ink jet printing identification on entire length of electrode
- Q2 Lot® Tested - A certificate showing actual wire composition and calculated ferrite number (FN) is available online

WELDING POSITIONS

All

CONFORMANCES

AWS A5: ER308LSi, ER308Si

ASME SFA-5.9: ER308LSi, ER308Si

TYPICAL APPLICATIONS

- 304 and 304L stainless steels
- Common austenitic stainless steels referred to as 18-8 steels
- ASTM A743, A744 Types CF-8 and CF-3

SHIELDING GAS

100% Ar

DIAMETERS / PACKAGING

Diameter in (mm)	10 lb (4.5 kg) Plastic Tube 30 lb (13.6 kg) Master Carton
1/16 (1.6)	ED037061
3/32 (2.4)	ED037062
1/8 (3.2)	ED036562
5/32 (4.0)	ED037063

WIRE COMPOSITION⁽¹⁾ – As Required per AWS A5.9/A5.9M: 2017

	%C	%Cr	%Ni	%Mo	%Mn	%Si	%P	%S	%Cu	Total Others
Requirements - AWS ER308LSi	0.03 max	19.5-22.0	9.0-11.0	0.75 max	1.0-2.5	0.65-1.00	0.03 max	0.03 max	0.75 max	Info Only
Typical Results⁽¹⁾	0.03	20.0	9.6	0.05	2.0	0.82	0.02	0.02	0.06	0.06
Requirements - AWS ER308Si	0.08 max	19.5-22.0	9.0-11.0	0.75 max	1.0-2.5	0.65-1.00	0.03 max	0.03 max	0.75 max	Info Only
Typical Results⁽¹⁾	0.03	20.0	9.6	0.05	2.0	0.82	0.02	0.02	0.06	0.06

IMPORTANT: SPECIAL VENTILATION AND/OR EXHAUST REQUIRED

Fumes from the normal use of some welding products can contain significant quantities of components - such as chromium and manganese - which can lower the 5.0 mg/m³ maximum exposure guideline for general welding fume. BEFORE USE, READ AND UNDERSTAND THE SAFETY DATA SHEET (SDS) FOR THIS PRODUCT AND SPECIFIC INFORMATION PRINTED ON THE PRODUCT CONTAINER.

LINCOLN® ER309/309L

Stainless · AWS ER309, ER309L

KEY FEATURES

- 0.03% carbon content increases resistance to intergranular corrosion
- Ink jet printing identification on entire length of electrode
- Q2 Lot® - Certificate showing actual wire composition and calculated ferrite number (FN) available online

WELDING POSITIONS

All

SHIELDING GAS

100% Argon

CONFORMANCES

AWS A5.9:	ER309, ER309L
CWB/CSA:	ER309, ER309L
ISO 14343-B:	SS309L
ABS:	ER309, ER309L

TYPICAL APPLICATIONS

- Sheet metal on the corresponding stainless steel base metals
- High pressure piping and tubing
- Use for welding dissimilar alloys in wrought or cast form
- Occasionally used for welding "18-8" base metals when severe corrosion conditions exist or dissimilar metals

DIAMETERS / PACKAGING

Diameter in (mm)	1 lb (0.5 kg) Plastic Tube 10 lb (4.5 kg) Master Carton	10 lb (4.5 kg) Plastic Tube 30 lb (13.6 kg) Master Carton
1/16 (1.6)	ED025419	ED034442
3/32 (2.4)	ED025422	ED034443
1/8 (3.2)	ED025425	ED034444

WIRE COMPOSITION – As Required per AWS A5.9

	%C ^(a)	%Cr	%Ni	%Mo	%Mn
Requirements - AWS ER309L	0.03 max	23.0 - 25.0	12.0 - 14.0	0.75 max	1.0 - 2.5
Typical Results ^(b)	0.02	23.7	13.9	0.04	1.8
	%Si	%P	%S	%Cu	Total Others
Requirements - AWS ER309L	0.30 - 0.65	0.03 max	0.03 max	0.75 max	0.50 max
Typical Results ^(b)	0.51	0.02	0.01	0.05	0.06

^(a)See test results disclaimer ^(b)Requirements for ER309 is 0.12% max. carbon.

IMPORTANT: SPECIAL VENTILATION AND/OR EXHAUST REQUIRED

Fumes from the normal use of some welding products can contain significant quantities of components - such as chromium and manganese - which can lower the 5.0 mg/m³ maximum exposure guideline for general welding fume. BEFORE USE, READ AND UNDERSTAND THE SAFETY DATA SHEET (SDS) FOR THIS PRODUCT AND SPECIFIC INFORMATION PRINTED ON THE PRODUCT CONTAINER.

LINCOLN® ER309Si/309LSi

Stainless · AWS ER309Si, ER309LSi

ER309LSi, ER309Si

KEY FEATURES

- High silicon level for increased puddle fluidity and wetting out at the toes
- Excellent weld contour minimizes the need for grinding
- Solid rod for welding stainless steel to carbon steel
- Ink jet printing identification on entire length of electrode
- Q2 Lot® Tested - A certificate showing actual wire composition and calculated ferrite number (FN) is available online

WELDING POSITIONS

All

CONFORMANCES

AWS A5.9: ER309LSi, ER309Si

ASME SFA-5.9: ER309LSi, ER309Si

TYPICAL APPLICATIONS

- Designed for joining stainless to mild or low alloy steel

SHIELDING GAS

100% Argon

DIAMETERS / PACKAGING

Diameter in (mm)	10 lb (4.5 kg) Plastic Tube 30 lb (13.6 kg) Master Carton
3/32 (2.4)	ED037113
1/8 (3.2)	ED037114
5/32 (4.0)	ED037115

WIRE COMPOSITION⁽¹⁾ – As Required per AWS A5.9/A5.9M

	%C	%Cr	%Ni	%Mo	%Mn	%Si	%P	%S	%Cu	Total Others
Requirements - AWS ER309LSi	0.03 max	23.0-25.0	12.0-14.0	0.75 max	1.0-2.5	0.65-1.00	0.03 max	0.03 max	0.75 max	Info Only
Typical Results⁽¹⁾	0.01	23.4	13.8	0.03	1.9	0.78	0.02	0.01	0.04	0.05
Requirements - AWS ER309Si	0.12 max	23.0-25.0	12.0-14.0	0.75 max	1.0-2.5	0.65-1.00	0.03 max	0.03 max	0.75 max	Info Only
Typical Results⁽¹⁾	0.01	23.4	13.8	0.03	1.9	0.78	0.02	0.01	0.04	0.05

IMPORTANT: SPECIAL VENTILATION AND/OR EXHAUST REQUIRED

Fumes from the normal use of some welding products can contain significant quantities of components - such as chromium and manganese - which can lower the 5.0 mg/m³ maximum exposure guideline for general welding fume. BEFORE USE, READ AND UNDERSTAND THE SAFETY DATA SHEET (SDS) FOR THIS PRODUCT AND SPECIFIC INFORMATION PRINTED ON THE PRODUCT CONTAINER.

LINCOLN® ER310

Stainless · AWS ER310

KEY FEATURES

- The weld deposit is fully austenitic, and as such, calls for minimal heat input during welding
- Ink jet printing identification on entire length of electrode
- Q2 Lot® - Certificate showing actual wire composition

WELDING POSITIONS

All

CONFORMANCES

AWS A5.9:	ER310
ASME SFA-5.9:	ER310
CWB/CSA:	ER310
ABS:	ER310

TYPICAL APPLICATIONS

- Head shields
- Furnace parts
- Ducting
- Used for welding stainless steels of similar composition in cast and wrought forms

SHIELDING GAS

100% Argon

DIAMETERS / PACKAGING

Diameter in (mm)	10 lb (4.5 kg) Tube 30 lb (13.6 kg) Master Carton
1/16 (1.6)	ED035214
3/32 (2.4)	ED035215
1/8 (3.2)	ED035216

WIRE COMPOSITION⁽¹⁾ – As Required per AWS A5.9

	%C	%Cr	%Ni	%Mo	%Mn
Requirements AWS ER310	0.08 - 0.15	25.0 - 28.0	20.0 - 22.5	0.75 max	1.0 - 2.5
Typical Results⁽²⁾	0.11	27.1	21.0		1.90
	%Si	%P	%S	%Cu	FN
Requirements AWS ER310	0.30 - 0.65	0.03 max	0.03 max	0.75 max	Not Required
Typical Results⁽²⁾	0.40	0.01	0.003	0.04	

⁽¹⁾Typical wire composition. ⁽²⁾See test results disclaimer

IMPORTANT: SPECIAL VENTILATION AND/OR EXHAUST REQUIRED

Fumes from the normal use of some welding products can contain significant quantities of components - such as chromium and manganese - which can lower the 5.0 mg/m³ maximum exposure guideline for general welding fume. BEFORE USE, READ AND UNDERSTAND THE SAFETY DATA SHEET (SDS) FOR THIS PRODUCT AND SPECIFIC INFORMATION PRINTED ON THE PRODUCT CONTAINER.

LINCOLN® ER312

Stainless · AWS ER312

KEY FEATURES

- Weld deposit work-hardens, providing good wear resistance and high tensile strength
- Applications should be limited to 800°F (420°C)
- Ink jet printing identification on entire length of electrode
- Q2 Lot® - Certificate showing actual wire composition and calculated ferrite number (FN) available online

WELDING POSITIONS

All

CONFORMANCES

AWS A5.9:	ER312
ASME SFA-5.9:	ER312
CWB/CSA:	ER312

TYPICAL APPLICATIONS

- Tool steels
- Hard to weld steels
- Cast and wrought alloys
- Dissimilar metals
- Used to weld cast and wrought alloys of similar compositions
- Can be used for joining hard to weld materials and dissimilar metals

SHIELDING GAS

100% Argon

DIAMETERS / PACKAGING

Diameter in (mm)	10 lb (4.5 kg) Tube 30 lb (13.6 kg) Master Carton
1/16 (1.6)	ED035217
3/32 (2.4)	ED035218
1/8 (3.2)	ED035219

WIRE COMPOSITION⁽¹⁾ – As Required per AWS A5.9

	%C	%Cr	%Ni	%Mo	%Mn
Requirements AWS ER312	0.15 max	28.0 - 32.0	8.0 - 10.5	0.75 max	1.0 - 2.5
Typical Results⁽²⁾	0.11	29.6	8.9		1.6
	%Si	%P	%S	%Cu	FN
Requirements AWS ER312	0.30 - 0.65	0.03 max	0.03 max	0.75 max	Not Required
Typical Results⁽²⁾	0.44	0.02	0.01	0.10	50 - 80

⁽¹⁾Typical wire composition. ⁽²⁾See test results disclaimer

IMPORTANT: SPECIAL VENTILATION AND/OR EXHAUST REQUIRED

Fumes from the normal use of some welding products can contain significant quantities of components - such as chromium and manganese - which can lower the 5.0 mg/m³ maximum exposure guideline for general welding fume. BEFORE USE, READ AND UNDERSTAND THE SAFETY DATA SHEET (SDS) FOR THIS PRODUCT AND SPECIFIC INFORMATION PRINTED ON THE PRODUCT CONTAINER.

LINCOLN® ER316/316L

Stainless · AWS ER316, ER316L

KEY FEATURES

- The 2-3% molybdenum improves pitting corrosion resistance of the weld deposit
- Molybdenum grade increases corrosion resistance
- Use for high temperature service applications
- 0.03% carbon content increases resistance to intergranular corrosion
- Ink jet printing identification on entire length of electrode
- Q2 Lot® - Certificate showing actual wire composition and calculated ferrite number (FN) available online

WELDING POSITIONS

All

CONFORMANCES

AWS A5:	ER316, ER316L
ASME SFA-5.9:	ER316, ER316L
CWB/CSA:	ER316, ER316L
ISO:	SS316L
ABS:	ER316, ER316L

TYPICAL APPLICATIONS

- Sheet metal on the corresponding stainless steel base metals
- High pressure piping and tubing
- Use for welding similar alloys containing approximately 2% molybdenum

SHIELDING GAS

100% Argon

DIAMETERS / PACKAGING

Diameter in (mm)	1 lb (0.5 kg) Plastic Tube 10 lb (4.5 kg) Master Carton	10 lb (4.5 kg) Plastic Tube 30 lb (13.6 kg) Master Carton
1/16 (1.6)	ED025428	ED034445
3/32 (2.4)	ED025431	ED034446
1/8 (3.2)	ED025434	ED034447
5/32 (4.0)		ED036061

WIRE COMPOSITION – As Required per AWS A5.9

	%C ^(a)	%Cr	%Ni	%Mo	%Mn
Requirements - AWS ER316L	0.03max	18.0 - 20.0	11.0 - 14.0	2.0 - 3.0	1.0 - 2.5
Typical Results^(b)	0.02	18.7	11.8	2.3	1.7
	%Si	%P	%S	%Cu	Total Others
Requirements - AWS ER316L	0.30 - 0.65	0.03 max	0.03 max	0.75 max	0.50 max
Typical Results^(b)	0.52	0.02	0.01	0.10	0.30

^(a) See test results disclaimer ^(b) Requirements for ER316 is 0.08% max. carbon.

IMPORTANT: SPECIAL VENTILATION AND/OR EXHAUST REQUIRED

Fumes from the normal use of some welding products can contain significant quantities of components - such as chromium and manganese - which can lower the 5.0 mg/m³ maximum exposure guideline for general welding fume. BEFORE USE, READ AND UNDERSTAND THE SAFETY DATA SHEET (SDS) FOR THIS PRODUCT AND SPECIFIC INFORMATION PRINTED ON THE PRODUCT CONTAINER.

LINCOLN® ER316/316LCF

Stainless · AWS ER316/ER316L

KEY FEATURES

- Controlled Low Ferrite (Range 3-6)
- Charpy V-Notch test results capable of exceeding 27 J (20 ft-lbf) @ -196°C (-320°F)
- Exceeds 15 mils (0.38 mm) of lateral expansion @ -196°C (-320°F)
- Batch Managed Inventory
- Ink jet printing identification on entire length of electrode
- Q2 Lot® - Certificates showing actual wire composition, ferrite number, and impact properties tested at -196°C (-320°F) available online

WELDING POSITIONS

All

CONFORMANCES

- AWS A5.9:** ER316, ER316L
ASME SFA-5.9: ER316, ER316L
ABS: ER316, ER316L

TYPICAL APPLICATIONS

- LNG Storage
- Cryogenic Vessels and Piping

SHIELDING GAS

100% Argon

TYPICAL BASE METALS

316L stainless steels

DIAMETERS / PACKAGING

Diameter in (mm)	10 lb (4.5 kg) Tube 30 lb (13.6 kg) Master Carton
1/16 (1.6)	ED034927
3/32 (2.4)	ED034928
1/8 (3.2)	ED034929

MECHANICAL PROPERTIES⁽¹⁾ – As Required per AWS A5.9

	Yield Strength ⁽²⁾ MPa (ksi)	Tensile Strength MPa (ksi)	Elongation %	Charpy V-Notch J (ft-lbf) -196°C (-320°F)	Lateral Expansion mils (mm) -196°C (-320°F)
Typical Results⁽³⁾ As-Welded with 100% Ar	430 (63)	570 (83)	42	70 (95)	42 (1.1)

WIRE COMPOSITION⁽¹⁾ – As Required per AWS A5.9

	%C	%Cr	%Ni	%Mo	%Mn
Requirements - AWS ER316L	0.03 max	18.0 - 20.0	11.0 - 14.0	2.0 - 3.0	1.0 - 2.5
Typical Results⁽³⁾	0.02	18.5	12.3	2.6	1.7
	%Si	%P	%S	%Cu	Total Others
Requirements - AWS ER316L	0.30 - 0.65	0.03 max	0.03 max	0.75 max	0.50 max
Typical Results⁽³⁾	0.40	0.02	0.01	0.17	0.30

⁽¹⁾ Typical all weld metal ⁽²⁾ Measured with 0.2% offset ⁽³⁾ See test results disclaimer

IMPORTANT: SPECIAL VENTILATION AND/OR EXHAUST REQUIRED

Fumes from the normal use of some welding products can contain significant quantities of components - such as chromium and manganese - which can lower the 5.0 mg/m³ maximum exposure guideline for general welding fume. BEFORE USE, READ AND UNDERSTAND THE SAFETY DATA SHEET (SDS) FOR THIS PRODUCT AND SPECIFIC INFORMATION PRINTED ON THE PRODUCT CONTAINER.

LINCOLN® ER316Si/316LSi

Stainless · AWS ER316Si, ER316LSi

KEY FEATURES

- High silicon level for increased puddle fluidity and wetting out at the toes
- Molybdenum grade for increased corrosion resistance
- Solid rod with low carbon for welding stainless CrNiMo-steels
- Ink jet printing identification on entire length of electrode
- Q2 Lot® Tested - A certificate showing actual wire composition and calculated ferrite number (FN) is available online

WELDING POSITIONS

All

CONFORMANCES

AWS A5.9: ER316LSi, ER316Si

ASME SFA-5.9: ER316LSi, ER316Si

TYPICAL APPLICATIONS

- Molybdenum bearing austenitic stainless steels
- Type 316 and 316L

SHIELDING GAS

100% Argon

DIAMETERS / PACKAGING

Diameter in (mm)	10 lb (4.5 kg) Plastic Tube 30 lb (13.6 kg) Master Carton
1/16 (1.6)	ED037064
3/32 (2.4)	ED037066
1/8 (3.2)	ED037065
5/32 (4.0)	ED037067

WIRE COMPOSITION – As Required per AWS A5.9/A5.9M

	%C	%Cr	%Ni	%Mo	%Mn	%Si	%P	%S	%Cu	Total Others
Requirements - AWS ER316LSi	0.03 max	18.0-20.0	11.0-14.0	2.0-3.0	1.0-2.5	0.65-1.00	0.03 max	0.03 max	0.75 max	Info Only
Typical Results⁽¹⁾	0.01	18.3	11.3	2.3	1.7	0.87	0.02	0.02	0.07	0.07
Requirements - AWS ER316Si	0.12 max	18.0-20.0	11.0-14.0	2.0-3.0	1.0-2.5	0.65-1.00	0.03 max	0.03 max	0.75 max	Info Only
Typical Results⁽¹⁾	0.01	18.3	11.3	2.3	1.7	0.87	0.02	0.02	0.07	0.07

⁽¹⁾See test results disclaimer

IMPORTANT: SPECIAL VENTILATION AND/OR EXHAUST REQUIRED

Fumes from the normal use of some welding products can contain significant quantities of components - such as chromium and manganese - which can lower the 5.0 mg/m³ maximum exposure guideline for general welding fume.
BEFORE USE, READ AND UNDERSTAND THE SAFETY DATA SHEET (SDS) FOR THIS PRODUCT AND SPECIFIC INFORMATION PRINTED ON THE PRODUCT CONTAINER.

LINCOLN® ER317/317L

Stainless · AWS ER317, ER317L

KEY FEATURES

- Weld deposit similar to 316L with a high molybdenum content for increased corrosion resistance
- Ink jet printing identification on entire length of electrode
- Q2 Lot® - Certificate showing actual wire composition and calculated ferrite number (FN) available online

WELDING POSITIONS

All

SHIELDING GAS

100% Argon

CONFORMANCES

AWS A5.9:	ER317, ER317L
ASME SFA-5.9:	ER317, ER317L
CWB/CSA:	ER317, ER317L

TYPICAL APPLICATIONS

- FGP
- Chemical Processing Plants
- Condensers
- Petrochemical
- Used for welding alloys with similar composition in high corrosive environments

DIAMETERS / PACKAGING

Diameter in (mm)	10 lb (4.5 kg) Tube 30 lb (13.6 kg) Master Carton
1/16 (1.6)	ED035227
3/32 (2.4)	ED035228
1/8 (3.2)	ED035229
5/32 (4.0)	ED035230

WIRE COMPOSITION⁽¹⁾ – As Required per AWS A5.9

	%C	%Cr	%Ni	%Mo	%Mn
Requirements AWS ER317/317L	0.03 max	18.5 - 20.5	13.0 - 15.0	3.0 - 4.0	1.0 - 2.5
Typical Results⁽²⁾	0.01	18.9	13.7	3.5	1.4
	%Si	%P	%S	%Cu	
Requirements AWS ER317/317L	0.30 - 0.65	0.03 max	0.03 max	0.75 max	
Typical Results⁽²⁾	0.45	0.01	0.008	0.08	

⁽¹⁾Typical wire composition. ⁽²⁾See test results disclaimer

IMPORTANT: SPECIAL VENTILATION AND/OR EXHAUST REQUIRED

Fumes from the normal use of some welding products can contain significant quantities of components - such as chromium and manganese - which can lower the 5.0 mg/m³ maximum exposure guideline for general welding fume. BEFORE USE, READ AND UNDERSTAND THE SAFETY DATA SHEET (SDS) FOR THIS PRODUCT AND SPECIFIC INFORMATION PRINTED ON THE PRODUCT CONTAINER.

LINCOLN® ER320LR

Stainless · AWS ER320LR

KEY FEATURES

- LR contains low residual elements for better resistance to hot cracking
- Excellent corrosion resistance in highly acidic environments
- Ink jet printing identification on entire length of electrode
- Q2 Lot® - Certificate showing actual wire composition

WELDING POSITIONS

All

SHIELDING GAS

100% Argon

CONFORMANCES

AWS A5.9: ER320LR
ASME SFA-5.9: ER320LR
CWB/CSA ER320LR: ER320LR

TYPICAL APPLICATIONS

- Tanks
 - Process Piping
 - Heat Exchangers
 - Typically used for welding
- base metals with similar compositions including alloy 20

DIAMETERS / PACKAGING

Diameter in (mm)	10 lb (4.5 kg) Tube 30 lb (13.6 kg) Master Carton
1/16 (1.6)	ED035231
3/32 (2.4)	ED035232
1/8 (3.2)	ED035233

WIRE COMPOSITION⁽¹⁾ – As Required per AWS A5.9

	%C	%Cr	%Ni	%Mo	%Mn
Requirements AWS ER320LR	0.025 max	19.0 - 21.0	32.0 - 36.0	2.0 - 3.0	1.5 - 2.0
Typical Results⁽²⁾	0.003	20.1	33.3	2.4	1.7
	%Si	%P	%S	%Cu	%Nb
Requirements AWS ER320LR	0.15 max	0.015 max	0.02 max	3.0 - 4.0	Required 8 x C / 1.0 max
Typical Results⁽²⁾	0.01	0.010	0.001	3.3	0.22

⁽¹⁾Typical wire composition. ⁽²⁾See test results disclaimer

IMPORTANT: SPECIAL VENTILATION AND/OR EXHAUST REQUIRED

Fumes from the normal use of some welding products can contain significant quantities of components - such as chromium and manganese - which can lower the 5.0 mg/m³ maximum exposure guideline for general welding fume. BEFORE USE, READ AND UNDERSTAND THE SAFETY DATA SHEET (SDS) FOR THIS PRODUCT AND SPECIFIC INFORMATION PRINTED ON THE PRODUCT CONTAINER.

LINCOLN® ER347

Stainless · AWS ER347

KEY FEATURES

- Niobium stabilized stainless steel electrodes
- The addition of niobium reduces intergranular corrosion in severe operating conditions
- Ink jet printing identification on entire length of electrode
- Q2 Lot® - Certificate showing actual wire composition and calculated ferrite number (FN) available online

WELDING POSITIONS

All

CONFORMANCES

AWS A5.9:	ER347
ASME SFA-5.9:	ER347
CWB/CSA:	ER347
ABS:	ER347

TYPICAL APPLICATIONS

- Food Processing
- Pharmaceutical Equipment
- Used for welding Types 347 and 321 stainless and stainless clad steels

SHIELDING GAS

100% Argon

DIAMETERS / PACKAGING

Diameter in (mm)	10 lb (4.5 kg) Tube 30 lb (13.6 kg) Master Carton
1/16 (1.6)	ED035235
3/32 (2.4)	ED035237
1/8 (3.2)	ED035239

WIRE COMPOSITION⁽¹⁾ – As Required per AWS A5.9

	%C	%Cr	%Ni	%Mo	%Nb + Ta
Requirements AWS ER347	0.08 max	19.0 - 21.5	9.0 - 11.0	0.75 max	10 x C - 1.0
Typical Results⁽²⁾	0.03	19.5	9.3	0.25	0.60
	%Mn	%Si	%P	%S	%Cu
Requirements AWS ER347	1.0 - 2.5	0.30 - 0.65	0.03 max	0.03 max	0.75 max
Typical Results⁽²⁾	1.7	0.45	0.01	0.007	0.10

⁽¹⁾Typical wire composition. ⁽²⁾See test results disclaimer

IMPORTANT: SPECIAL VENTILATION AND/OR EXHAUST REQUIRED

Fumes from the normal use of some welding products can contain significant quantities of components - such as chromium and manganese - which can lower the 5.0 mg/m³ maximum exposure guideline for general welding fume. BEFORE USE, READ AND UNDERSTAND THE SAFETY DATA SHEET (SDS) FOR THIS PRODUCT AND SPECIFIC INFORMATION PRINTED ON THE PRODUCT CONTAINER.

LINCOLN® ER385

Stainless · AWS ER385

KEY FEATURES

- Weld metal is fully austenitic and must be done with low heat input using a stringer bead technique
- Ink jet printing identification on entire length of electrode
- Q2 Lot® - Certificate showing actual wire composition and calculated ferrite number (FN) available online

WELDING POSITIONS

All

SHIELDING GAS

100% Argon

CONFORMANCES

AWS A5.9: ER385

ASME SFA-5.9: ER385

TYPICAL APPLICATIONS

- Pipeline segment
- Agitators
- Rotars
- Used in fabrication of equipment and vessels for handling and storage of sulfuric acid and phosphoric acid
- Used for welding materials of similar chemical composition (Type 904L)

DIAMETERS / PACKAGING

Diameter in (mm)	10 lb (4.5 kg) Tube 30 lb (13.6 kg) Master Carton
1/16 (1.6)	ED035240
3/32 (2.4)	ED035241

WIRE COMPOSITION⁽¹⁾ – As Required per AWS A5.9

	%C	%Cr	%Ni	%Mo	%Mn
Requirements AWS ER385	0.025 max	19.5 - 21.5	24.0 - 26.0	4.2 - 5.2	1.0 - 2.5
Typical Results⁽²⁾	0.010	19.9	25.0	4.2	1.8
	%Si	%P	%S	%Cu	
Requirements AWS ER385	0.50 max	0.02 max	0.03 max	1.2 - 2.0	
Typical Results⁽²⁾	0.3	0.01	0.001	1.4	

⁽¹⁾Typical wire composition. ⁽²⁾See test results disclaimer

IMPORTANT: SPECIAL VENTILATION AND/OR EXHAUST REQUIRED

Fumes from the normal use of some welding products can contain significant quantities of components - such as chromium and manganese - which can lower the 5.0 mg/m³ maximum exposure guideline for general welding fume. BEFORE USE, READ AND UNDERSTAND THE SAFETY DATA SHEET (SDS) FOR THIS PRODUCT AND SPECIFIC INFORMATION PRINTED ON THE PRODUCT CONTAINER.

LINCOLN® ER409Nb

Stainless · AWS ER409Nb

KEY FEATURES

- A ferritic stainless steel welding wire
- The addition of niobium improves corrosion resistance and promotes a ferritic micro-structure
- For the best results, welding must be done in a low heat input procedure and is not recommended for multi-pass applications
- Ink jet printing identification on entire length of electrode
- Q2 Lot® - Certificate showing actual wire composition and calculated ferrite number (FN) available online

WELDING POSITIONS

All

CONFORMANCES

AWS A5.9: ER409Nb
ASME SFA-5.9: ER409Nb

TYPICAL APPLICATIONS

- Automotive exhausts
- Used to weld Type 409 and 409Ti base materials

SHIELDING GAS

100% Argon

DIAMETERS / PACKAGING

Diameter in (mm)	10 lb (4.5 kg) Tube 30 lb (13.6 kg) Master Carton
1/16 (1.6)	ED035242
3/32 (2.4)	ED035243

WIRE COMPOSITION⁽¹⁾ – As Required per AWS A5.9

	%C	%Cr	%Ni	%Mo	%Nb
Requirements AWS ER409Nb	0.08 max	10.5 - 13.5	0.6 max.	0.50 max	0.075 max
Typical Results⁽²⁾	0.04	11.5	0.4	0.03	0.50
	%Mn	%Si	%P	%S	%Cu
Requirements AWS ER409Nb	0.8 max	1.0 max	0.04 max	0.03 max	0.75 max
Typical Results⁽²⁾	0.62	0.48	0.02	0.02	0.04

⁽¹⁾Typical wire composition. ⁽²⁾See test results disclaimer

IMPORTANT: SPECIAL VENTILATION AND/OR EXHAUST REQUIRED

Fumes from the normal use of some welding products can contain significant quantities of components - such as chromium and manganese - which can lower the 5.0 mg/m³ maximum exposure guideline for general welding fume. BEFORE USE, READ AND UNDERSTAND THE SAFETY DATA SHEET (SDS) FOR THIS PRODUCT AND SPECIFIC INFORMATION PRINTED ON THE PRODUCT CONTAINER.

LINCOLN® ER410

Stainless · AWS ER410

KEY FEATURES

- Designed to weld stainless steels of similar chemical composition as well as to overlay carbon steels to impart corrosion, erosion and abrasion resistance
- This material, being an air-hardening type, calls for a pre-heat and inter-pass temperature of 400°F (200°C) or greater during welding
- Ink jet printing identification on entire length of electrode
- Q2 Lot® - Certificate showing actual wire composition

WELDING POSITIONS

All

CONFORMANCES

AWS A5.9:	ER410
ASME SFA-5.9:	ER410
CWB/CSA:	ER410

TYPICAL APPLICATIONS

- Surfacing Steel Mill Rolls
- Furnace and Burner Parts
- Turbine Parts

SHIELDING GAS

100% Argon

DIAMETERS / PACKAGING

Diameter in (mm)	10 lb (4.5 kg) Tube 30 lb (13.6 kg) Master Carton
1/16 (1.6)	ED035244
3/32 (2.4)	ED035245
1/8 (3.2)	ED035246

WIRE COMPOSITION⁽¹⁾ – As Required per AWS A5.9

	%C	%Cr	%Ni	%Mo	%Mn
Requirements AWS ER410	0.12 max	11.5 - 13.5	0.6 max	0.75 max	0.6 max
Typical Results⁽²⁾	0.11	12.5	0.1	0.03	0.45
	%Si	%P	%S	%Cu	
Requirements AWS ER410	0.5 max	0.03 max	0.03 max	0.75 max	
Typical Results⁽²⁾	0.39	0.01	0.01	0.14	

⁽¹⁾Typical wire composition. ⁽²⁾See test results disclaimer

IMPORTANT: SPECIAL VENTILATION AND/OR EXHAUST REQUIRED

Fumes from the normal use of some welding products can contain significant quantities of components - such as chromium and manganese - which can lower the 5.0 mg/m³ maximum exposure guideline for general welding fume. BEFORE USE, READ AND UNDERSTAND THE SAFETY DATA SHEET (SDS) FOR THIS PRODUCT AND SPECIFIC INFORMATION PRINTED ON THE PRODUCT CONTAINER.

LINCOLN® ER410NiMo

Stainless · AWS ER410NiMo

KEY FEATURES

- Used to overlay mild and low alloy steels
- Preheat and inter-pass temperatures of 300°F (150°C) or greater is recommended during welding
- Post-weld heat treatment should not exceed 1150°F (620°C) as higher temperatures may result in hardening
- Ink jet printing identification on entire length of electrode
- Q2 Lot® - Certificate showing actual wire composition

WELDING POSITIONS

All

CONFORMANCES

AWS A5.9: ER410NiMo
ASME SFA-5.9: ER410NiMo

TYPICAL APPLICATIONS

- Turbines
- Valve Bodies
- High Pressure Piping
- Offshore
- Power Generation
- Designed to weld materials of similar chemical composition in cast and wrought forms

SHIELDING GAS

100% Argon

DIAMETERS / PACKAGING

Diameter in (mm)	10 lb (4.5 kg) Tube 30 lb (13.6 kg) Master Carton
1/16 (1.6)	ED035247
3/32 (2.4)	ED035248

WIRE COMPOSITION⁽¹⁾ – As Required per AWS A5.9

	%C	%Cr	%Ni	%Mo	%Mn
Requirements AWS ER410NiMo	0.06 max	11.0 - 12.5	4.0 - 5.0	0.4 - 0.7	0.6 max
Typical Results⁽²⁾	0.02	11.7	4.7	0.5	0.2
	%Si	%P	%S	%Cu	
Requirements AWS ER410NiMo	0.5 max	0.03 max	0.03 max	0.75 max	
Typical Results⁽²⁾	0.2	0.01	0.002	0.06	

⁽¹⁾Typical wire composition. ⁽²⁾See test results disclaimer

IMPORTANT: SPECIAL VENTILATION AND/OR EXHAUST REQUIRED

Fumes from the normal use of some welding products can contain significant quantities of components - such as chromium and manganese - which can lower the 5.0 mg/m³ maximum exposure guideline for general welding fume. BEFORE USE, READ AND UNDERSTAND THE SAFETY DATA SHEET (SDS) FOR THIS PRODUCT AND SPECIFIC INFORMATION PRINTED ON THE PRODUCT CONTAINER.

LINCOLN® ER630

Stainless · AWS ER630

KEY FEATURES

- Precipitation hardening martensitic stainless steel used for welding materials of similar chemical composition such as 17-4 and 17-7 plates
- Can be used in as welded condition or may be heat treated to obtain higher strength
- Mechanical properties of the alloy are greatly influenced by the heat treatment
- Ink jet printing identification on entire length of electrode
- Q2 Lot® - Certificate showing actual wire composition and calculated ferrite number (FN) available online

WELDING POSITIONS

All

CONFORMANCES

AWS A5.9: ER630

CWB/CSA: ER630

TYPICAL APPLICATIONS

- Hydraulic Equipment Components
- Impellers
- Pump Shafts

SHIELDING GAS

100% Argon

DIAMETERS / PACKAGING

Diameter in (mm)	10 lb (4.5 kg) Tube 30 lb (13.6 kg) Master Carton
1/16 (1.6)	ED035250
3/32 (2.4)	ED035252

WIRE COMPOSITION⁽¹⁾ – As Required per AWS A5.9

	%C	%Cr	%Ni	%Mo	%Nb
Requirements AWS ER630	0.05 max	16.00 - 16.75	4.5 - 5.0	0.75 max	0.15 - 0.30
Typical Results⁽²⁾	0.03	16.5	4.8	0.2	0.22
	%Mn	%Si	%P	%S	%Cu
Requirements AWS ER630	0.25 - 0.75	0.75 max	0.03 max	0.03 max	3.25 - 4.0
Typical Results⁽²⁾	0.54	0.43	0.02	0.02	3.6

⁽¹⁾Typical wire composition. ⁽²⁾See test results disclaimer

IMPORTANT: SPECIAL VENTILATION AND/OR EXHAUST REQUIRED

Fumes from the normal use of some welding products can contain significant quantities of components - such as chromium and manganese - which can lower the 5.0 mg/m³ maximum exposure guideline for general welding fume. BEFORE USE, READ AND UNDERSTAND THE SAFETY DATA SHEET (SDS) FOR THIS PRODUCT AND SPECIFIC INFORMATION PRINTED ON THE PRODUCT CONTAINER.

LINCOLN® ER2209

Stainless · AWS ER2209

KEY FEATURES

- The welds offer excellent resistance to stress corrosion, cracking and pitting
- The microstructure of the weld metal consists of austenite and ferrite
- The ferrite content of the weld metal will be lower than the ferrite content of type 2205 base metal
- Welding of duplex stainless steels calls for controlled welding parameters to achieve specified mechanical and corrosion resistant properties
- Ink jet printing identification on entire length of electrode
- Q2 Lot® - Certificate showing actual wire composition and calculated ferrite number (FN) available online

WELDING POSITIONS

All

CONFORMANCES

AWS A5.9:	ER2209
ASME SFA-5.9:	ER2209
CWB/CSA:	ER2209
ABS:	ER2209

TYPICAL APPLICATIONS

- Offshore
- Oil and Gas
- Chemical
- Petrochemical
- Used to weld duplex stainless steels such as (Type 2205)

SHIELDING GAS

100% Argon

DIAMETERS / PACKAGING

Diameter in (mm)	10 lb (4.5 kg) Tube 30 lb (13.6 kg) Master Carton
1/16 (1.6)	ED035191
3/32 (2.4)	ED035192
1/8 (3.2)	ED035193

WIRE COMPOSITION⁽¹⁾ – As Required per AWS A5.9

	%C	%Cr	%Ni	%Mo	%Mn	%Si
Requirements AWS ER2209	0.03 max	21.5 - 23.5	7.5 - 9.5	2.5 - 3.5	0.5 - 2.0	0.90 max
Typical Results⁽²⁾	0.01	22.7	8.5	3.0	1.4	0.4
	%P	%S	%N	%Cu	FN	
Requirements AWS ER2209	0.03 max	0.03 max	0.08 - 0.20	0.75 max	Not Required	
Typical Results⁽²⁾	0.01	0.001	0.15	0.06	30 - 60	

⁽¹⁾Typical wire composition. ⁽²⁾See test results disclaimer

IMPORTANT: SPECIAL VENTILATION AND/OR EXHAUST REQUIRED

Fumes from the normal use of some welding products can contain significant quantities of components - such as chromium and manganese - which can lower the 5.0 mg/m³ maximum exposure guideline for general welding fume. BEFORE USE, READ AND UNDERSTAND THE SAFETY DATA SHEET (SDS) FOR THIS PRODUCT AND SPECIFIC INFORMATION PRINTED ON THE PRODUCT CONTAINER.

LINCOLN® ER2594

Stainless · AWS ER2594

KEY FEATURES

- A super-duplex grade electrode that provides matching chemistry and mechanical property characteristics to wrought super-duplex alloys such as 2507 and Zeron 100, as well as to super-duplex casting alloys (ATSM A890)
- The electrode is over-alloyed with nitrogen to provide the optimum ferrite/austenite ratio in the finished weld resulting in high tensile and yield strength and superior resistance to stress corrosion, cracking (SCC) and pitting corrosion
- Ink jet printing identification on entire length of electrode
- Q2 Lot® - Certificate showing actual wire composition and calculated ferrite number (FN) available online

WELDING POSITIONS

All

CONFORMANCES

AWS A5.9:	ER2594
CWB/CSA:	ER2594
ABS:	ER2594

TYPICAL APPLICATIONS

- Process Pipework
- Pumps and Valves
- Pressure Vessels
- Used to weld superduplex stainless steels such as Type 2507 and Zeron 100

SHIELDING GAS

100% Argon

DIAMETERS / PACKAGING

Diameter in (mm)	10 lb (4.5 kg) Tube 30 lb (13.6 kg) Master Carton
1/16 (1.6)	ED035194
3/32 (2.4)	ED035195
1/8 (3.2)	ED035196

WIRE COMPOSITION⁽¹⁾ – As Required per AWS A5.9

	%C	%Cr	%Ni	%Mo	%Mn	%Si
Requirements AWS ER2594	0.03 max	24.0 - 27.0	8.0 - 10.5	2.5 - 4.5	2.5 max	1.0 max
Typical Results⁽²⁾	0.02	24.6	8.6	3.8	0.8	0.3
	%P	%S	%N	%Cu	%W	FN
Requirements AWS ER2594	0.03 max	0.02 max	0.20 - 0.30	1.5 max	1.00 max	Not Required
Typical Results⁽²⁾	0.02	0.01	0.25	0.01	0.01	30 - 60

⁽¹⁾Typical wire composition. ⁽²⁾See test results disclaimer

IMPORTANT: SPECIAL VENTILATION AND/OR EXHAUST REQUIRED

Fumes from the normal use of some welding products can contain significant quantities of components - such as chromium and manganese - which can lower the 5.0 mg/m³ maximum exposure guideline for general welding fume. BEFORE USE, READ AND UNDERSTAND THE SAFETY DATA SHEET (SDS) FOR THIS PRODUCT AND SPECIFIC INFORMATION PRINTED ON THE PRODUCT CONTAINER.

ER16.8.2

Stainless · AWS ER16-8-2

KEY FEATURES

- 16% Chromium, 8% nickel, 2% molybdenum cut length
- Low ferrite weld deposit (1-5)
- Cryogenic toughness properties down to -196°C [-320°F]
- Designed to weld 304H, 316H, 321 and 347H base materials

WELDING POSITIONS

All

SHIELDING GAS

100% Argon

CONFORMANCES

AWS A5.9	ER16-8-2
BS EN ISO 14343-A	16 8 2
BS EN ISO 14343-B	SS16-8-2

TYPICAL APPLICATIONS

- Furnace parts
- Gas and steam turbine
- Petrochemical
- Chemical process plants
- Power generation industries
- Cryogenic applications
- Catalytic crackers
- Steam Piping

DIAMETERS / PACKAGING

Diameter mm [in]	5 kg (11 lb) Tube
2.5 (3/32)	TER1682-24
3.2 (1/8)	TER1682-32

MECHANICAL PROPERTIES⁽¹⁾ – As Required per AWS A5.9

	Yield Strength ⁽²⁾ MPa (ksi)	Tensile Strength MPa (ksi)	Elongation %	Charpy V-Notch J (ft-lbf) @-196°C [-321°F]
Requirements AWS ER16-8-2 As-Welded	-	550 (80)	35 min	-
Typical Results⁽³⁾ As-Welded	420 (61)	620 (90)	40	30 (22)

DEPOSIT COMPOSITION⁽¹⁾ – As Required per AWS A5.9

	%C	%Mn	%Si	%S	%P
Requirements AWS ER16-8-2	0.10 max	1.0-2.0	0.3-0.6	0.02 max	0.03 max
Typical Results⁽³⁾	0.06	1.4	0.4	0.01	0.01
	%Cr	%Ni	%Mo	%Cu	
Requirements AWS ER16-8-2	14.5-16.5	7.5-9.5	1.0-2.0	0.75 max	
Typical Results⁽³⁾	15.5	8.5	1.3	0.1	

⁽¹⁾ Typical wire composition. ⁽²⁾ Measured with 0.2% offset. ⁽³⁾ See test results disclaimer.

IMPORTANT: SPECIAL VENTILATION AND/OR EXHAUST REQUIRED

Fumes from the normal use of some welding products can contain significant quantities of components - such as chromium and manganese - which can lower the 5.0 mg/m³ maximum exposure guideline for general welding fume. BEFORE USE, READ AND UNDERSTAND THE SAFETY DATA SHEET (SDS) FOR THIS PRODUCT AND SPECIFIC INFORMATION PRINTED ON THE PRODUCT CONTAINER.

PRIMALLOY® T-409Ti

Stainless · AWS EC409

KEY FEATURES

- Minimal spatter and slag
- Great deposition rates
- High travel speed welding on thin material

WELDING POSITIONS

All Positions

CONFORMANCES

AWS A5.22: EC409

CWB/SCA: EC409

TYPICAL APPLICATIONS

- Designed for joining components of automotive exhaust systems, such as catalytic converters
- Single pass welding

SHIELDING GAS

98% Argon / 2% Oxygen

DIAMETERS / PACKAGING

Diameter mm [in]	33 lb (15 kg) Plastic Spool	500 lb (227 kg) Bulk Drum
1.2 (0.045)	ED034208	ED034209

DEPOSIT COMPOSITION⁽¹⁾ – As Required per AWS A5.22

	%C	%Cr	%Ni	%Mo	%Mn
Requirements AWS EC409	0.08	10.5-13.5	0.6	0.5	0.8
Typical Results⁽²⁾ 98% Argon / 2% O ₂	0.03	11.1	0.02	0.03	0.5
	%Si	%P	%S	%Ti	
Requirements AWS EC409	0.8	0.03	0.03	10xC min 1.5 max	
Typical Results⁽²⁾ 98% Argon / 2% O ₂	0.6	0.007	0.008	1.0	

TYPICAL OPERATING PROCEDURES

Diameter, Polarity, Shielding Gas	CTWD in (mm)	Wire Feed Speed in/min (m/min)	Voltage (Volts)	Approx. Current (Amps)
0.045 (1.2), DC+ 98% Argon / 2% CO ₂	5/8 (15.8)	200 (5.08)	22	200
		250 (6.35)	23	230
		300 (7.62)	25	260
		450 (11.43)	28	335

⁽¹⁾Typical all weld metal. ⁽²⁾See test results disclaimer

IMPORTANT: SPECIAL VENTILATION AND/OR EXHAUST REQUIRED

Fumes from the normal use of some welding products can contain significant quantities of components - such as chromium and manganese - which can lower the 5.0 mg/m³ maximum exposure guideline for general welding fume. BEFORE USE, READ AND UNDERSTAND THE SAFETY DATA SHEET (SDS) FOR THIS PRODUCT AND SPECIFIC INFORMATION PRINTED ON THE PRODUCT CONTAINER.

PRIMALLOY® T-439Ti

Stainless · AWS EC439

KEY FEATURES

- Minimal spatter and slag
- Great deposition rates
- High travel speed welding on thin material

WELDING POSITIONS

All Positions

CONFORMANCES

AWS A5.22: EC439
CWB/CSA: EC439

TYPICAL APPLICATIONS

- Designed for joining components of automotive exhaust systems, such as catalytic converters
- Single pass welding

SHIELDING GAS

98% Argon / 2% Oxygen

DIAMETERS / PACKAGING

Diameter mm (in)	33 lb (15 kg) Plastic Spool	500 lb (227 kg) Bulk Drum
1.2 (0.045)	ED034293	ED034294

DEPOSIT COMPOSITION⁽¹⁾ – As Required per AWS A5.22

	%C	%Cr	%Ni	%Mo	%Mn
Requirements AWS EC439	0.04	17.0-19.0	0.6	0.5	0.8
Typical Results⁽²⁾ 98% Argon / 2% O ₂	0.03	17.5	0.02	0.02	0.47
	%Si	%P	%S	%Ti	
Requirements AWS EC439	0.8	0.03	0.03	10xC min 1.1 max	
Typical Results⁽²⁾ 98% Argon / 2% O ₂	0.4	0.01	0.01	0.4	

TYPICAL OPERATING PROCEDURES

Diameter, Polarity, Shielding Gas	CTWD in (mm)	Wire Feed Speed in/min (m/min)	Voltage (Volts)	Approx. Current (Amps)
0.045 (1.2), DC+ 98% Argon / 2% CO ₂	5/8 (15.8)	200 (5.08)	22	200
		250 (6.35)	23	230
		300 (7.62)	25	260
		450 (11.43)	28	335

⁽¹⁾Typical all weld metal. ⁽²⁾See test results disclaimer

IMPORTANT: SPECIAL VENTILATION AND/OR EXHAUST REQUIRED

Fumes from the normal use of some welding products can contain significant quantities of components - such as chromium and manganese - which can lower the 5.0 mg/m³ maximum exposure guideline for general welding fume. BEFORE USE, READ AND UNDERSTAND THE SAFETY DATA SHEET (SDS) FOR THIS PRODUCT AND SPECIFIC INFORMATION PRINTED ON THE PRODUCT CONTAINER.

PRIMALLOY™ T-430LNb

Stainless · JIS Z 3323 TS430Nb-MA0

KEY FEATURES

- Minimal spatter and slag
- Great deposition rates
- High travel speed welding on thin material

CONFORMANCES

JIS Z 3323: TS430Nb-MA0

TYPICAL APPLICATIONS

- Designed for joining components of automotive exhaust systems, such as catalytic converters
- Single pass welding

WELDING POSITIONS

All Positions

SHIELDING GAS

98% Argon / 2% Oxygen

DIAMETERS / PACKAGING

Diameter in (mm)	33 lb (15 kg) Plastic Spool	500 lb (227 kg) Bulk Drum
1.2 (0.045)	ED037181	ED037182

WIRE COMPOSITION^(a) – As Required per JIS TS430Nb

	%C	%Cr	%Ni	%Mo	%Mn
Requirements - JIS TS430Nb [Max]	0.10	18.0	0.60	0.50	1.2
Typical Results^(b) - 98% Argon / 2% O ₂	0.012	16.91	0.006	0.017	0.41
	%Si	%P	%S	%Nb	%Ti
Requirements - JIS TS430Nb [Max]	1.0	0.04	0.03	1.5	—
Typical Results^(b) - 98% Argon / 2% O ₂	0.49	0.006	0.015	0.602	0.194

^(a)Typical all weld metal. ^(b)See test results disclaimer

TYPICAL OPERATING PROCEDURES

Diameter (Pulse Mode) Shielding Gas	CTWD	Wire Feed Speed in/min (m/min)	Voltage (Volts)	Approx. Current (Amps)
0.045 (1.2), DC+ 98% Argon / 2% O ₂	1/2 in	100 (2.54)	14.6	80
		150 (3.81)	16.0	110
		200 (5.08)	18.5	150
		250 (6.35)	20.0	200
		300 (7.62)	21.5	230
		350 (8.89)	22.5	260
		400 (10.16)	24.5	270

TYPICAL OPERATING PROCEDURES

Diameter (CV Mode) Shielding Gas	CTWD	Wire Feed Speed in/min (m/min)	Voltage (Volts)	Approx. Current (Amps)
0.045 (1.2) 98% Argon / 2% O ₂	1/2 in	150 (3.81)	16-18	150-170
		200 (5.08)	20.5-22.5	180-200
		270 (6.858)	23-24	210-230
		300 (7.62)	23-25	240-260
		350 (8.89)	24-26	260-290
		380 (9.652)	24-26	280-300

PRIMALLOY® T-439Nb

Stainless · AWS A5.22 EC439Nb

KEY FEATURES

- Minimal spatter and slag
- Great deposition rates
- High travel speed welding on thin material

WELDING POSITIONS

All Positions

DIAMETERS / PACKAGING

Diameter mm [in]	33 lb (15 kg) Plastic Spool	500 lb (227 kg) Bulk Drum	750 lb (340 kg) Bulk Drum
1.2 (0.045)	ED037342	ED037343	ED037344

DEPOSIT COMPOSITION⁽¹⁾ – As Required per AWS A5.22 EC439Nb

	%C	%Cr	%Ni	%Mo	%Mn	%N
Requirements AWS A5.22 EC439Nb [Max]	0.04	17.0-20.0	0.60	0.50	0.8	—
Typical Results⁽²⁾ 98% Argon / 2% O ₂	0.01	17.6	0.006	0.0	0.4	0.03
	%Si	%P	%S	%Nb+TA	%Ti	%Cu
Requirements AWS A5.22 EC439Nb	0.8	0.03	0.03	0.75	0.10 - 0.75	0.75
Typical Results⁽²⁾ 98% Argon / 2% O ₂	0.5	0.01	0.02	0.67	0.29	0.03

TYPICAL OPERATING PROCEDURES

Diameter (Pulse Mode) Shielding Gas	CTWD	Wire Feed Speed in/min (m/min)	Voltage (Volts)	Approx. Current (Amps)
0.045 (1.2), DC+ 98% Argon / 2% O ₂	1/2 in	100 (2.54)	14.6	80
		150 (3.81)	16.0	110
		200 (5.08)	18.5	150
		250 (6.35)	20.0	200
		300 (7.62)	21.5	230
		350 (8.89)	22.5	260
		400 (10.16)	24.5	270

TYPICAL OPERATING PROCEDURES

Diameter (CV Mode) Shielding Gas	CTWD	Wire Feed Speed in/min (m/min)	Voltage (Volts)	Approx. Current (Amps)
0.045 (1.2) 98% Argon / 2% O ₂	1/2 in	150 (3.81)	16-18	150-170
		200 (5.08)	20.5-22.5	180-200
		270 (6.858)	23-24	210-230
		300 (7.62)	23-25	240-260
		350 (8.89)	24-26	260-290
		380 (9.652)	24-26	280-300

⁽¹⁾Typical all weld metal. ⁽²⁾See test results disclaimer

IMPORTANT: SPECIAL VENTILATION AND/OR EXHAUST REQUIRED

Fumes from the normal use of some welding products can contain significant quantities of components - such as chromium and manganese - which can lower the 5.0 mg/m³ maximum exposure guideline for general welding fume. BEFORE USE, READ AND UNDERSTAND THE SAFETY DATA SHEET (SDS) FOR THIS PRODUCT AND SPECIFIC INFORMATION PRINTED ON THE PRODUCT CONTAINER.

BLUE MAX® ORBITAL TIG 308/308L

Stainless · AWS ER308, ER308L

KEY FEATURES

- Ultra-clean wire for porosity free welds
- Batch Managed Inventory
- Q2 Lot® certificate showing actual wire composition and calculated ferrite number (FN) available online

WELDING POSITIONS

All

SHIELDING GAS

100% Argon

CONFORMANCES

AWS A5.9: ER308, ER308L
ASME SFA-A5.9: ER308, ER308L

TYPICAL APPLICATIONS

- Process Piping
- Thermal Energy
- Petroleum Processing

DIAMETERS / PACKAGING

Diameter in (mm)	2 lb (0.9 kg) PLW Spool 8 lb (3.6 kg) Carton	10 lb (4.5 kg) PLW Spool
0.035 (0.9)	ED034153	ED034155
0.045 (1.2)		ED038028

WIRE COMPOSITION⁽¹⁾ – As Required per AWS A5.9

	%C	%Mn	%Si	%S	%P	%Cr
Requirements AWS ER308/308L	0.03 max	1.0-2.5	0.30-0.65	0.03 max	0.03 max	19.5-22.0
Typical Results⁽²⁾	0.02	1.30	0.40	<0.01	0.02	20.30
	%Ni	%Mo	%Cu	%N	FN	
Requirements AWS ER308/308L	9.0-11.0	0.75 max	0.75 max	Not Specified	Not Required	
Typical Results⁽²⁾	10.20	0.16	0.16	0.02	N/A	

⁽¹⁾Typical wire composition. ⁽²⁾See test results disclaimer

IMPORTANT: SPECIAL VENTILATION AND/OR EXHAUST REQUIRED

Fumes from the normal use of some welding products can contain significant quantities of components - such as chromium and manganese - which can lower the 5.0 mg/m³ maximum exposure guideline for general welding fume. BEFORE USE, READ AND UNDERSTAND THE SAFETY DATA SHEET (SDS) FOR THIS PRODUCT AND SPECIFIC INFORMATION PRINTED ON THE PRODUCT CONTAINER.

BLUE MAX® ORBITAL TIG 309/309L

Stainless · AWS ER309, ER309L

KEY FEATURES

- Ultra-clean wire for porosity free welds
- Batch Managed Inventory
- Q2 Lot® certificate showing actual wire composition and calculated ferrite number (FN) available online

WELDING POSITIONS

All

SHIELDING GAS

100% Argon

CONFORMANCES

AWS A5.9: ER309, ER309L
ASME SFA-A5.9: ER309, ER309L

TYPICAL APPLICATIONS

- Process Piping
- Thermal Energy
- Petroleum Processing
- Used for joining stainless steels to themselves to low alloy or mild steel

DIAMETERS / PACKAGING

Diameter in (mm)	2 lb (0.9 kg) PLW Spool 8 lb (3.6 kg) Carton	10 lb (4.5 kg) PLW Spool
0.035 (0.9)	ED034157	ED034159

WIRE COMPOSITION⁽¹⁾ – As Required per AWS A5.9

	%C	%Mn	%Si	%S	%P	%Cr
Requirements AWS ER309/309L	0.03 max	1.0-2.5	0.30-0.65	0.03 max	0.03 max	23.0-25.0
Typical Results⁽²⁾	0.02	1.60	0.36	<0.01	0.02	23.80
	%Ni	%Mo	%Cu	%N	FN	
Requirements AWS ER309/309L	12.0-14.0	0.75 max	0.75 max	Not Specified	Not Required	
Typical Results⁽²⁾	13.30	0.12	0.10	0.08	N/A	

⁽¹⁾Typical wire composition. ⁽²⁾See test results disclaimer

IMPORTANT: SPECIAL VENTILATION AND/OR EXHAUST REQUIRED

Fumes from the normal use of some welding products can contain significant quantities of components - such as chromium and manganese - which can lower the 5.0 mg/m³ maximum exposure guideline for general welding fume. BEFORE USE, READ AND UNDERSTAND THE SAFETY DATA SHEET (SDS) FOR THIS PRODUCT AND SPECIFIC INFORMATION PRINTED ON THE PRODUCT CONTAINER.

BLUE MAX® ORBITAL TIG 316/316L

Stainless · AWS ER316, ER316L

KEY FEATURES

- Ultra-clean wire for porosity free welds
- Good resistance to pitting, many acids, and general corrosion
- Batch Managed Inventory
- Q2 Lot® certificate showing actual wire composition and calculated ferrite number (FN) available online

CONFORMANCES

AWS A5.9:	ER316, ER316L
ASME SFA-A5.9	ER316, ER316L
ISO 14343-B:	SS316L
ABS:	ER316, ER316L

WELDING POSITIONS

All

SHIELDING GAS

100% Argon

TYPICAL APPLICATIONS

- Process Piping
- Thermal Energy
- Petroleum Processing

DIAMETERS / PACKAGING

Diameter in (mm)	2 lb (0.9 kg) PLW Spool 8 lb (3.6 kg) Carton	10 lb (4.5 kg) PLW Spool
0.035 (0.9)	ED034161	ED034163
0.045 (1.2)		ED038029

WIRE COMPOSITION⁽¹⁾ – As Required per AWS A5.9

	%C	%Mn	%Si	%S	%P	%Cr
Requirements AWS ER316/316L	0.03 max	1.0-2.5	0.30-0.65	0.03 max	0.03 max	18.0-20.0
Typical Results⁽²⁾	0.02	1.70	0.37	0.01	0.02	19.60
	%Ni	%Mo	%Cu	%N	FN	
Requirements AWS ER316/316L	11.0-14.0	2.0-3.0	0.75 max	Not Specified	Not Required	
Typical Results⁽²⁾	11.70	2.10	0.04	0.02	N/A	

⁽¹⁾Typical wire composition. ⁽²⁾See test results disclaimer

IMPORTANT: SPECIAL VENTILATION AND/OR EXHAUST REQUIRED

Fumes from the normal use of some welding products can contain significant quantities of components - such as chromium and manganese - which can lower the 5.0 mg/m³ maximum exposure guideline for general welding fume. BEFORE USE, READ AND UNDERSTAND THE SAFETY DATA SHEET (SDS) FOR THIS PRODUCT AND SPECIFIC INFORMATION PRINTED ON THE PRODUCT CONTAINER.

CONSUMABLES
NICKEL



TECH-ROD® 55

Nickel · AWS ENiFe-C I

KEY FEATURES

- The welds are moderately hard and require carbide tipped tools for machining
- A preheat and inter-pass temperature of not less than 350°F (177°C) is required during welding to prevent cracking
- Q2 Lot® - certificates showing actual deposit composition available online

POLARITY

DC+

CONFORMANCES

AWS A5.15:	ENiFe-C I
ASME SFA-5.15:	ENiFe-C I
UNS:	W82002

TYPICAL APPLICATIONS

- Welding of ductile, pliable cast irons
- Dissimilar welds to nickel alloys, carbon steels, and low-alloy steels
- Repair of castings

DIAMETERS / PACKAGING

Diameter in (mm)	Length in (mm)	8 lb (3.6 kg) Can 24 lb (10.9 kg) Master Carton	10 lb (4.5 kg) Can 30 lb (13.6 kg) Master Can
3/32 (2.4)	12 (305)	EL55093632	
1/8 (3.2)	14 (355)		EL55125634
5/32 (4.0)	14 (355)		EL55156634

DEPOSIT COMPOSITION⁽¹⁾ - As Required per AWS A5.15

	%C	%Mn	%Si	%S	%Fe
Requirements AWS ENiFe-C I	2.0 max	2.5 max	4.0 max	0.03 max	Remainder
Typical Results⁽²⁾ Tech-Rod® 55	1.3	0.4	1.0	0.003	—
	%Ni	%Cu	%Al	%Other	
Requirements AWS ENiFe-C I	45.0 - 60.0	2.5 max	1.0 max	1.0 max	
Typical Results⁽²⁾ Tech-Rod® 55	50.0	1.0	0.5	—	

TYPICAL OPERATING PROCEDURES

Diameter in (mm)	Amperage	
	Flat	Vertical & Overhead
3/32 (2.4)	70-85	65-75
1/8 (3.2)	85-110	80-90
5/32 (4.0)	110-140	110-120

⁽¹⁾Typical deposit composition. ⁽²⁾See test results disclaimer
Safety Data Sheets (SDS) are available on our website at www.lincolnelectric.com

TECH-ROD® 99

Nickel · AWS ENi-CI

KEY FEATURES

- Used for welding of cast irons to other cast irons as well as for joining cast irons to mild steels and stainless steels
- A preheat and inter-pass temperature of not less than 350°F (177°C) is required during welding to prevent cracking
- Q2 Lot® - certificates showing actual deposit composition available online

POLARITY

DC+

CONFORMANCES

AWS A5.15:	ENi-CI
ASME SFA-5.15:	ENi-C I
UNS:	W82001

TYPICAL APPLICATIONS

- Generally more machinable than a Tech-Rod® 55 deposit
- Intended to join and repair pliable cast iron

DIAMETERS / PACKAGING

Diameter in (mm)	Length in (mm)	8 lb (3.6 kg) Can 24 lb (10.9 kg) Master Carton	10 lb (4.5 kg) Can 30 lb (13.6 kg) Master Can
3/32 (2.4)	12 (305)	EL99093632	
1/8 (3.2)	14 (355)		EL99125634
5/32 (4.0)	14 (355)		EL99156634
3/16 (4.7)	14 (355)		EL99125634

DEPOSIT COMPOSITION⁽¹⁾ - As Required per AWS A5.15

	%C	%Mn	%Si	%S	%Fe
Requirements AWS ENi-CI	2.0 max	2.5 max	4.0 max	0.03 max	8.0 max
Typical Results⁽²⁾ Tech-Rod® 99	1.5	0.6	0.2	0.002	3.0
	%Ni	%Cu	%Al	%Other	
Requirements AWS ENi-CI	85.0 min	2.5 max	1.0 max	1.0 max	
Typical Results⁽²⁾ Tech-Rod® 99	94.0	0.1	0.1	-	

TYPICAL OPERATING PROCEDURES

Diameter in (mm)	Amperage	
	Flat	Vertical & Overhead
3/32 (2.4)	70-85	65-75
1/8 (3.2)	85-110	80-90
5/32 (4.0)	110-140	110-120

⁽¹⁾Typical deposit composition. ⁽²⁾See test results disclaimer
Safety Data Sheets (SDS) are available on our website at www.lincolnelectric.com

TECH-ROD® 112

Nickel · AWS ENiCrMo-3

KEY FEATURES

- A covered electrode which is used to weld nickel-chromium-molybdenum alloys
- These electrodes are used in applications where the temperature ranges from cryogenic up to 1800°F (982°C)
- Q2 Lot® - certificates showing actual deposit composition available online

POLARITY

DC+

DIAMETERS / PACKAGING

Diameter in (mm)	Length in (mm)	8 lb (3.6 kg) Can 24 lb (10.9 kg) Master Carton	10 lb (4.5 kg) Can 30 lb (13.6 kg) Master Can
3/32 (2.4)	12 (305)	EL112093632	
1/8 (3.2)	14 (355)		EL112125634
5/32 (4.0)	14 (355)		EL112156634
3/16 (4.8)	14 (355)		EL112187634

MECHANICAL PROPERTIES - As Required per AWS A5.11

	Tensile Strength Mpa (ksi)	Elongation %
Requirements AWS A5.11/A5.11M:2010	690 (110 min)	30 min
Typical Results^(a) Tech-Rod® 112	790 (114)	42

DEPOSIT COMPOSITION^(b) - As Required per AWS A5.11

	%C	%Mn	%Fe	%P	%S	%Si
Requirements AWS ENiCrMo-3	0.10 max	1.0 max	7.0 max	0.03 max	0.02 max	0.75 max
Typical Results^(a) Tech-Rod® 112	0.05	0.5	1.9	0.01	0.003	0.33
	%Cu	%Ni	%Cr	%Nb+Ta	%Mo	%Other
Requirements AWS ENiCrMo-3	0.50 max	55.0 min	20.0 - 23.0	3.15 - 4.15	8.0 - 10.0	0.50 max
Typical Results^(a) Tech-Rod® 112	0.01	62.1	22.4	3.63	8.7	<0.5

TYPICAL OPERATING PROCEDURES

Diameter in (mm)	Amperage	
	Flat	Vertical & Overhead
3/32 (2.4)	70-85	65-75
1/8 (3.2)	85-110	80-90
5/32 (4.0)	110-140	110-120
3/16 (4.8)	120-160	110-130

^(a)Typical deposit composition. ^(b)See test results disclaimer
Safety Data Sheets (SDS) are available on our website at www.lincolnelectric.com

CONFORMANCES

AWS A5.11:	ENiCrMo-3
ASME SFA-5.11:	ENiCrMo-3
UNS:	W86112
CWB/CSA:	ENiCrMo-3
ABS:	ENiCrMo-3

TYPICAL APPLICATIONS

- Used extensively in overlay cladding where a similar chemical composition is required on the clad side
- Dissimilar joints between nickel-chromium molybdenum alloys to stainless steels, carbon or low alloys steels
- Welding alloy 625

TECH-ROD® 112LFe

Nickel · AWS ENiCrMo-3

KEY FEATURES

- A low iron version of the standard Tech-Rod® 112 covered electrode which is used to weld nickel-chromium-molybdenum alloys
- The product is designed to have less than 1% Iron (Fe) for overlay applications where low iron is required
- Product typically achieves Fe levels of 1% or less in a weld deposit
- Q2 Lot® - certificates showing actual deposit composition available online

POLARITY

DC+

CONFORMANCES

AWS A5.11:	ENiCrMo-3
ASME SFA-5.11:	ENiCrMo-3
UNS:	W86112

TYPICAL APPLICATIONS

- Used extensively in overlay cladding where a similar chemical composition is required on the clad side
- Dissimilar joints between nickel-chromium molybdenum alloys to stainless steels, carbon or low alloys steels
- Welding alloy 625

DIAMETERS / PACKAGING

Diameter in (mm)	Length in (mm)	10 lb (4.5 kg) Can 30 lb (13.6 kg) Master Can
1/8 [3.2]	14 [355]	EL112LFE125634
5/32 [4.0]	14 [355]	EL112LFE156634
3/16 [4.8]	14 [355]	EL112LFE187634

MECHANICAL PROPERTIES - As Required per AWS A5.11

	Tensile Strength Mpa (ksi)	Elongation %
Requirements AWS A5.11/A5.11M:2010	690 (110) min	30 min
Typical Results^(a) Tech-Rod® 112LFe	770 (111)	42

DEPOSIT COMPOSITION^(a) - As Required per AWS A5.11

	%C	%Mn	%Fe	%P	%S	%Si
Requirements AWS ENiCrMo-3	0.10 max	1.0 max	7.0 max	0.03	0.02 max	0.75 max
Typical Results^(a) Tech-Rod® 112LFe	0.02	0.5	0.9	0.01	0.01	0.3
	%Cu	%Ni	%Cr	%Nb+Ta	%Mo	%Other
Requirements AWS ENiCrMo-3	0.50 max	55.00 min	20.0 - 23.0	3.15 - 4.15	8.0 - 10.0	0.50 max
Typical Results^(a) Tech-Rod® 112LFe	0.01	62.7	22.5	3.72	8.7	-

TYPICAL OPERATING PROCEDURES

Diameter in (mm)	Amperage	
	Flat	Vertical & Overhead
1/8 [3.2]	85-110	80-90
5/32 [4.0]	110-140	110-120
3/16 [4.8]	120-160	110-130

^(a)Typical deposit composition. ^(b)See test results disclaimer
Safety Data Sheets (SDS) are available on our website at www.lincolnelectric.com

TECH-ROD® 117

Nickel · AWS ENiCrCoMo-1

KEY FEATURES

- A covered electrode used for welding of nickel-chromium-cobalt-molybdenum alloys
- The deposited weld metal provides optimum strength and oxidation resistance between 1500°F to 2100°F, especially when welding on base metals of nickel-iron-chromium alloys
- Q2 Lot® - certificates showing actual deposit composition available online

CONFORMANCES

AWS A5.11:	ENiCrCoMo-1
ASME SFA-A5.11:	EniCrCoMo-1
UNS:	W86117

TYPICAL APPLICATIONS

- Overlay cladding where similar composition is required
- Turbine fabrication

POLARITY

DC+

DIAMETERS / PACKAGING

Diameter in (mm)	Length in (mm)	8 lb (3.6 kg) Can 24 lb (10.9 kg) Master Carton	10 lb (4.5 kg) Can 30 lb (13.6 kg) Master Can
3/32 [2.4]	12 [305]	EL117093632	
1/8 [3.2]	14 [355]		EL117125634
5/32 [4.0]	14 [355]		EL117156634
3/16 [4.8]	14 [355]		EL117187634

MECHANICAL PROPERTIES - As Required per AWS A5.11

	Tensile Strength Mpa (ksi)	Elongation %
Requirements AWS A5.11/A5.11M:2010	620 (90) min	30 min
Typical Results⁽²⁾	760 (110)	40

DEPOSIT COMPOSITION⁽¹⁾ - As Required per AWS A5.11

	%C	%Mn	%Fe	%P	%S
Requirements⁽²⁾ AWS ENiCrCoMo-1	0.05 - 0.15	0.3 - 2.5	5.0 max	0.03 max	0.015 max
Typical Results⁽²⁾	0.09	1.1	0.9	0.02	0.008
	%Si	%Cu	%Ni	%Co	
Requirements AWS ENiCrCoMo-1	0.75 max	0.50 max	Remainder	9.0 - 15.0	
Typical Results⁽²⁾	0.47	0.01	50.7	11.4	
	%Cr	%Nb+Ta	%Mo	%Other	
Requirements AWS ENiCrCoMo-1	21.0 - 26.0	1.0 max	8.0 - 10.0	0.50 max	
Typical Results⁽²⁾	24.7	0.9	9.4	-	

TYPICAL OPERATING PROCEDURES

Diameter in (mm)	Amperage	
	Flat	Vertical & Overhead
3/32 [2.4]	70-85	65-75
1/8 [3.2]	85-110	80-90
5/32 [4.0]	110-140	100-120
3/16 [4.8]	120-160	110-130

⁽¹⁾Typical deposit composition. ⁽²⁾See test results disclaimer
Safety Data Sheets (SDS) are available on our website at www.lincolnelectric.com

TECH-ROD® 122

Nickel · AWS ENiCrMo-10

KEY FEATURES

- Excellent corrosion resistance in oxidizing as well as reducing media in a wide variety of chemical process environments
- Offers an outstanding resistance to stress corrosion cracking, pitting and crevice corrosion
- Q2 Lot® - certificates showing actual deposit composition available online

POLARITY

DC+

CONFORMANCES

AWS A5.11:	ENiCrMo-10
ASME SFA-A5.11:	ENiCrMo-10
UNS:	W86122
CWB/CSA:	ENiCrMo-10

TYPICAL APPLICATIONS

- Used for welding of nickel-chromium-molybdenum alloys as well as for overlay cladding on carbon, low alloy or stainless steels
- Used for dissimilar joints between nickel-chromium-molybdenum alloys and stainless, carbon or low alloy steels

DIAMETERS / PACKAGING

Diameter in (mm)	Length in (mm)	8 lb (3.6 kg) Can 24 lb (10.9 kg) Master Can	10 lb (4.5 kg) Can 30 lb (13.6 kg) Master Can
3/32 (2.4)	12 (305)	EL122093632	EL122125634
1/8 (3.2)	14 (355)		
5/32 (4.0)	14 (355)		

MECHANICAL PROPERTIES - As Required per AWS A5.11

	Tensile Strength Mpa (ksi)	Elongation %
Requirements AWS A5.11/A5.11M:2010	690 (100) min	25 min
Typical Results^(a)	730 (105)	39

DEPOSIT COMPOSITION^(b) - As Required per AWS A5.11

	%C	%Mn	%Fe	%P	%S
Requirements AWS ENiCrMo-10	0.02 max	1.0 max	2.0 - 6.0	0.03 max	0.015 max
Typical Results^(a)	0.02	0.4	4.8	0.01	0.004
	%Si	%Cu	%Ni	%Co	%Cr
Requirements AWS ENiCrMo-10	0.2 max	0.50 max	Remainder	2.5 max	20.0 - 22.5
Typical Results^(a)	0.1	0.001	56.7	0.014	21.0
	%Nb+Ta	%Mo	%V	%W	%Other
Requirements AWS ENiCrMo-10	Not Specified	12.5 - 14.5	0.35 max	2.5 - 3.5	0.50 max
Typical Results^(a)	0.008	13.4	0.01	3.4	—

TYPICAL OPERATING PROCEDURES

Diameter in (mm)	Amperage	
	Flat	Vertical & Overhead
3/32 (2.4)	70-85	65-75
1/8 (3.2)	85-110	80-90
5/32 (4.0)	110-140	100-120

^(a)Typical deposit composition. ^(b)See test results disclaimer
Safety Data Sheets (SDS) are available on our website at www.lincolnelectric.com

TECH-ROD® 141

Nickel · AWS ENi-1

KEY FEATURES

- High nickel alloy
- Used for welding commercially pure nickel to themselves or steels
- Q2 Lot® - certificates showing actual deposit composition available online

POLARITY

DC+

CONFORMANCES

AWS A5.11: ENi-1
 ASME SFA-A5.11: ENi-1
 UNS: W82141

TYPICAL APPLICATIONS

- Used for joining Cu-Ni to stainless steels
- Welding of cast and wrought forms of pure Nickel alloys

DIAMETERS / PACKAGING

Diameter in (mm)	Length in (mm)	8 lb [3.6 kg] Can 24 lb [10.9 kg] Master Carton	10 lb [4.5 kg] Can 30 lb [13.6 kg] Master Can
3/32 [2.4]	12 [305]	EL141093632	
1/8 [3.2]	14 [355]		EL141125634
5/32 [4.0]	14 [355]		EL141156634
3/16 [4.8]	14 [355]		EL141187634

MECHANICAL PROPERTIES - As Required per AWS A5.11

	Tensile Strength Mpa (ksi)	Elongation %
Requirements AWS A5.11/A5.11M:2010	410 [60] min	20 min
Typical Results⁽²⁾	430 [63]	21

DEPOSIT COMPOSITION⁽¹⁾ - As Required per AWS A5.11

	%C	%Mn	%Fe	%P	%S	%Si
Requirements AWS ENi-1	0.10 max	0.75 max	0.75 max	0.03 max	0.02 max	1.25 max
Typical Results⁽²⁾	0.02	0.30	0.40	0.01	0.01	0.48
	%Cu	%Ni	%Ti	%Al	%Other	
Requirements AWS ENi-1	0.25 max	92.0 min	1.0 - 4.0	1.0 max	0.50 max	
Typical Results⁽²⁾	0.01	96.7	1.2	0.03	-	

TYPICAL OPERATING PROCEDURES

Diameter in (mm)	Flat	Amperage	Vertical & Overhead
3/32 [2.4]	70-85		65-75
1/8 [3.2]	85-110		80-90
5/32 [4.0]	110-140		100-120
3/16 [4.8]	120-160		110-130

⁽¹⁾Typical deposit composition. ⁽²⁾See test results disclaimer
 Safety Data Sheets (SDS) are available on our website at www.lincolnelectric.com

TECH-ROD® 182

Nickel · AWS ENiCrFe-3

KEY FEATURES

- Ideal for oxidation resistance and high temperature strength
- Wide range of applications
- Q2 Lot® - certificates showing actual deposit composition available online

POLARITY

DC+

CONFORMANCES

AWS A5.11:	ENiCrFe-3
ASME SFA-A5.11:	ENiCrFe-3
UNS:	W86182
CWB/CSA:	ENiCrFe-3

TYPICAL APPLICATIONS

- Used for welding nickel-chromium-iron alloys to themselves
- Used for dissimilar welding between nickel-chromium-iron alloys to mild steel or stainless steel

DIAMETERS / PACKAGING

Diameter in (mm)	Length in (mm)	8 lb (3.6 kg) Can 24 lb (10.9 kg) Master Carton	10 lb (4.5 kg) Can 30 lb (13.6 kg) Master Carton
3/32 [2.4]	12 [305]	EL182093632	
1/8 [3.2]	14 [355]		EL182125634
5/32 [4.0]	14 [355]		EL182156634
3/16 [4.8]	14 [355]		EL182187634

MECHANICAL PROPERTIES - As Required per AWS A5.11

	Tensile Strength Mpa (ksi)	Elongation %
Requirements AWS A5.11/A5.11M:2010	550 (80) min	30 min
Typical Results⁽²⁾ Tech-Rod® 182	600 (87)	34

DEPOSIT COMPOSITION⁽¹⁾ - As Required per AWS A5.11

	%C	%Mn	%Fe	%P	%S	%Si
Requirements AWS ENiCrFe-3	0.10 max	5.0 - 9.5	10.0 max	0.03 max	0.015 max	1.0 max
Typical Results⁽²⁾ Tech-Rod® 182	0.04	5.7	8.4	0.02	0.005	0.3
	%Cu	%Ni	%Ti	%Cr	%Nb+Ta	%Other
Requirements AWS ENiCrFe-3	0.50 max	59.0 min	1.0 max	13.0 - 17.0	1.0 - 2.5	0.50 max
Typical Results⁽²⁾ Tech-Rod® 182	0.04	68.5	0.1	15.1	1.2	<0.5

TYPICAL OPERATING PROCEDURES

Diameter in (mm)	Amperage	
	Flat	Vertical & Overhead
3/32 [2.4]	70-85	65-75
1/8 [3.2]	85-110	80-90
5/32 [4.0]	110-140	100-120
3/16 [4.8]	120-160	110-130

⁽¹⁾Typical deposit composition. ⁽²⁾See test results disclaimer
Safety Data Sheets (SDS) are available on our website at www.lincolnelectric.com

TECH-ROD® 187

Nickel · AWS ECuNi

KEY FEATURES

- A copper-nickel electrode for welding alloys of similar composition as well as 70/30 and 90/10 Cu/Ni alloys
- Q2 Lot® - certificates showing actual deposit composition available online

POLARITY

DC+

CONFORMANCES

AWS A5.6:	ECuNi
ASME SFA-A5.11:	ECuNi
UNS:	W60715

TYPICAL APPLICATIONS

- Marine applications
- Good resistance to the corrosive effects of sea water
- Used for the clad side of copper-nickel clad steels

DIAMETERS / PACKAGING

Diameter in (mm)	Length in (mm)	8 lb [3.6 kg] Can 24 lb [10.9 kg] Master Carton	10 lb [4.5 kg] Can 30 lb [13.6 kg] Master Can
3/32 [2.4]	12 [305]	EL187093632	EL187125634
1/8 [3.2]	14 [355]		

MECHANICAL PROPERTIES - As Required per AWS A5.6

	Tensile Strength Mpa (ksi)	Elongation %
Requirements AWS A5.11/A5.11M:2010	345 [50] min	20 min
Typical Results⁽²⁾ Tech-Rod® 187	360 [52]	24

DEPOSIT COMPOSITION⁽¹⁾ - As Required per AWS A5.6

	%Mn	%Fe	%P	%Si	%Cu
Requirements AWS ECuNi	1.00 - 2.50	0.40 - 0.75	0.020 max	0.50 max	Remainder
Typical Results⁽²⁾ Tech-Rod® 187	1.58	0.60	0.001	0.01	63.0
	%Ni	%Ti	%Pb	%Other	
Requirements AWS ECuNi	29.0 - 33.0	0.50 max	0.02 max	0.50 max	
Typical Results⁽²⁾ Tech-Rod® 187	30.4	0.24	0.001	<0.50	

TYPICAL OPERATING PROCEDURES

Diameter in (mm)	Amperage	
	Flat	Vertical & Overhead
3/32 [2.4]	70-85	65-75
1/8 [3.2]	85-110	80-90

⁽¹⁾Typical deposit composition. ⁽²⁾See test results disclaimer
Safety Data Sheets (SDS) are available on our website at www.lincolnelectric.com

TECH-ROD® 190

Nickel · AWS ENiCu-7

KEY FEATURES

- Dissimilar applications include nickel alloys to copper-nickel alloys
- Q2 Lot® - certificates showing actual deposit composition available online

POLARITY

DC+

CONFORMANCES

AWS A5.11:	ENiCu-7
ASME SFA-A5.11:	ENiCu-7
UNS:	W84190

TYPICAL APPLICATIONS

- Welding nickel-copper alloys to themselves and to steel
- Used for overlay welding as well as for welding clad steels nickel-copper surfacing is required
- Welding nickel-copper alloys to themselves and stainless

DIAMETERS / PACKAGING

Diameter in (mm)	Length in (mm)	8 lb [3.6 kg] Can 24 lb [10.9 kg] Master Carton	10 lb [4.5 kg] Can 30 lb [13.6 kg] Master Carton
3/32 [2.4]	12 [305]	EL190093632	
1/8 [3.2]	14 [355]		EL190125634
5/32 [4.0]	14 [355]		EL190156634
3/16 [4.8]	14 [355]		EL190187634

MECHANICAL PROPERTIES - As Required per AWS A5.11

	Tensile Strength Mpa (ksi)	Elongation %
Requirements AWS A5.11/A5.11M:2010	480 (70) min	30 min
Typical Results⁽²⁾ Tech-Rod® 190	500 (72)	44

DEPOSIT COMPOSITION⁽¹⁾ - As Required per AWS A5.11

	%C	%Mn	%Fe	%P	%S	%Si
Requirements AWS ENiCu-7	0.15	4.0 max	2.5 max	0.02 max	0.015 max	1.5 max
Typical Results⁽²⁾ Tech-Rod® 190	0.02	2.8	0.9	0.01	0.004	0.60
	%Cu	%Ni	%Al	%Ti	%Other	
Requirements AWS ENiCu-7	Remainder	62 - 69	0.75 max	1.0 max	0.5 max	
Typical Results⁽²⁾ Tech-Rod® 190	30	64.5	0.03	0.30	<0.5 max	

TYPICAL OPERATING PROCEDURES

Diameter in (mm)	Amperage	
	Flat	Vertical & Overhead
3/32 [2.4]	70-85	65-75
1/8 [3.2]	85-110	80-90
5/32 [4.0]	110-140	100-120
3/16 [4.8]	120-160	110-130

⁽¹⁾Typical deposit composition. ⁽²⁾See test results disclaimer
Safety Data Sheets (SDS) are available on our website at www.lincolnelectric.com

TECH-ROD® 276

Nickel · AWS ENiCrMo-4

KEY FEATURES

- Due to high molybdenum content, this alloy offers excellent resistance to stress corrosion cracking and pitting and crevice corrosion
- This low carbon, nickel-chromium-molybdenum tungsten alloy can also be used for dissimilar welding between nickel base alloys and stainless steels, as well as for surfacing and cladding
- Q2 Lot® - certificates showing actual deposit composition available online

CONFORMANCES

AWS A5.11:	ENiCrMo-4
ASME SFA-A5.11:	ENiCrMo-4
UNS:	W80276
CWB/CSA:	ENiCrMo-4

TYPICAL APPLICATIONS

- Used for welding materials of similar composition

POLARITY

DC+

DIAMETERS / PACKAGING

Diameter in (mm)	Length in (mm)	8 lb (3.6 kg) Can 24 lb (10.9 kg) Master Carton	10 lb (4.5 kg) Can 30 lb (13.6 kg) Master Can
3/32 (2.4)	12 (305)	EL276093632	
1/8 (3.2)	14 (355)		EL276125634
5/32 (4.0)	14 (355)		EL276156634
3/16 (4.8)	14 (355)		EL276187634

MECHANICAL PROPERTIES - As Required per AWS A5.11

	Tensile Strength Mpa (ksi)	Elongation %
Requirements AWS A5.11/A5.11M	690 (100) min	25 min
Typical Results⁽²⁾ Tech-Rod® 276	750 (108)	46

DEPOSIT COMPOSITION⁽¹⁾ - As Required per AWS A5.11

	%C	%Mn	%Fe	%P	%S	%Si	%Cu
Requirements AWS ENiCrMo-4	0.02 max	1.0 max	4.0 - 7.0	0.04 max	0.03 max	0.2 max	0.50 max
Typical Results⁽²⁾ Tech-Rod® 276	0.02	0.7	5.7	0.02	0.001	0.1	0.01
	%Ni	%Co	%Cr	%Mo	%V	%W	%Other
Requirements AWS ENiCrMo-4	Remainder	2.5 max	14.5 - 16.5	15.0 - 17.0	0.35 max	3.0 - 4.5	0.50 max
Typical Results⁽²⁾ Tech-Rod® 276	58.6	0.10	15.6	15.5	0.04	3.9	<0.50

TYPICAL OPERATING PROCEDURES

Diameter in (mm)	Amperage	
	Flat	Vertical & Overhead
3/32 (2.4)	70-85	65-75
1/8 (3.2)	85-110	80-90
5/32 (4.0)	110-140	100-120
3/16 (4.8)	120-160	110-130

⁽¹⁾Typical deposit composition. ⁽²⁾See test results disclaimer
Safety Data Sheets (SDS) are available on our website at www.lincolnelectric.com

TECH-ROD® WELD A

Nickel · AWS ENiCrFe-2

KEY FEATURES

- Overlay cladding where a similar composition is needed
- Q2 Lot® - certificates showing actual deposit composition available online

POLARITY

DC+

CONFORMANCES

AWS A5.11: ENiCrFe-2

TYPICAL APPLICATIONS

- For dissimilar welds between nickel-chromium-iron alloys to mild steels or stainless steels
- Furnace equipment
- Petrochemical plants

DIAMETERS / PACKAGING

Diameter in (mm)	Length in (mm)	8 lb (3.6 kg) Can 24 lb (10.9 kg) Master Carton	10 lb (4.5 kg) Can 30 lb (13.6 kg) Master Carton
3/32 (2.4)	12 (305)	ELWLDA093632	ELWLDA125634 ELWLDA156634 ELWLDA187634
1/8 (3.2)	14 (355)		
5/32 (4.0)	14 (355)		
3/16 (4.8)	14 (355)		

MECHANICAL PROPERTIES - As Required per AWS A5.11

	Tensile Strength Mpa (ksi)	Elongation %
Requirements AWS A5.11/A5.11M	550 (80) min	30 min
Typical Results⁽¹⁾ Tech-Rod® Weld A	650 (94)	42

DEPOSIT COMPOSITION⁽¹⁾ - As Required per AWS A5.11

	%C	%Mn	%Fe	%P	%S	%Si
Requirements AWS ENiCrFe-2	0.10 max	1.0 - 3.5	12.0 max	0.03 max	0.02 max	0.75 max
Typical Results⁽¹⁾ Tech-Rod® Weld A	0.04	2.6	10.0	0.012	0.004	0.40
	%Cu	%Ni	%Cr	%Nb+Ta	%Mo	%Other
Requirements AWS ENiCrFe-2	0.50 max	62.0 min	13.0 - 17.0	0.5 - 3.0	0.5 - 2.5	0.50 max
Typical Results⁽¹⁾ Tech-Rod® Weld A	0.06	67	15	2.0	0.96	0.50

TYPICAL OPERATING PROCEDURES

Diameter in (mm)	Flat	Amperage	Vertical & Overhead
3/32 (2.4)	70-85	Vertical & Overhead	65-75
1/8 (3.2)	85-110		80-90
5/32 (4.0)	110-140		100-120
3/16 (4.8)	120-160		110-130

⁽¹⁾Typical deposit composition. ⁽²⁾See test results disclaimer
Safety Data Sheets (SDS) are available on our website at www.lincolnelectric.com

TECHALLOY® 55

Nickel · AWS Similar to ENiFe-C I

KEY FEATURES

- The welds are moderately hard and require carbide tipped tools for machining
- A preheat and inter-pass temperature of not less than 350°F (175°C) is required during welding on cast iron to minimize the potential for cracks
- Q2 Lot® - certificates showing actual wire composition available online

WELDING POSITIONS

All

CONFORMANCES

Similar to AWS A5.15: ENiFe-C I

TYPICAL APPLICATIONS

- Used for welding of cast irons to other cast irons as well as for joining cast irons to mild steels
- Readily used for the repair of castings

SHIELDING GAS

MIG 75% Ar / 25% He

TIG 100% Ar

DIAMETERS / PACKAGING

Diameter in (mm)	MIG 33 lb (15 kg) Steel Spool	TIG 10 lb (4.5 kg) Tube 30 lb (13.6 kg) Master Carton
0.035 (0.9)	MG55035667	
0.045 (1.1)	MG55045667	
1/8 (3.2)		TG55125638

WIRE COMPOSITION - As Required per AWS A5.15

	%C	%Mn	%Si	%S	%Fe
Requirements⁽¹⁾ AWS ENiFe-C I	2.0 max	2.5 max	4.0 max	0.03 max	Remainder
Typical Results⁽²⁾ Techalloy® 55	0.03	0.7	0.1	0.002	44.5
	%Ni	%Cu	%Al	%Other	
Requirements⁽¹⁾ AWS ENiFe-C I	45-60	2.5 max	1.0 max	1.0 max	
Typical Results⁽²⁾ Techalloy® 55	54	0.1	0.1	<0.50	

TYPICAL OPERATING PROCEDURES

Process / Polarity	Diameter in (mm)	Voltage (volts)	Amperage	Gas
MIG / DC+	0.035 (0.9)	26-29	150-190	75% Argon / 25% Helium
	0.045 (1.1)	28-32	180-220	

⁽¹⁾Weld metal composition. ⁽²⁾See test results disclaimer
Safety Data Sheets (SDS) are available on our website at www.lincolnelectric.com

TECHALLOY® 99

Nickel · AWS ERNi-CI

KEY FEATURES

- Welds produced are generally more machinable than a Tech-Rod® 55 deposit
- A preheat and inter-pass temperature of not less than 350°F (175°C) is required during welding on cast iron to minimize the potential for cracks
- Q2 Lot® - certificates showing actual wire composition available online

WELDING POSITIONS

All

CONFORMANCES

AWS A5.15: ERNi-CI
ASME SFA-5.15: ERNi-CI

TYPICAL APPLICATIONS

- Used for welding of cast irons to other cast irons as well as for joining cast irons to mild steels and stainless steels
- Readily used for the repair of castings

SHIELDING GAS

MIG 75% Ar / 25% He
TIG 100% Ar

DIAMETERS / PACKAGING

Diameter in (mm)	MIG 33 lb (15 kg) Steel Spool	MIG 250 lb (113.4 kg) Accu-Trak® Drum	TIG 10 lb (4.5 kg) Tube 30 lb (13.6 kg) Master Carton
0.035 (0.9)	MG99035667		
0.045 (1.1)	MG99045667	MG99045684	
3/32 (2.4)			TG99093638

WIRE COMPOSITION - As Required per AWS A5.15

	%C	%Mn	%Si	%S	%Fe
Requirements AWS ERNi-CI	1.0 max	2.5 max	0.75 max	0.03 max	4.0 max
Typical Results⁽¹⁾ Techalloy® 99	0.003	0.07	0.09	0.001	0.1
	%Ni	%Cu	%Al	%Other	
Requirements AWS ERNi-CI	90 min	4.0 max	-	1.0 max	
Typical Results⁽¹⁾ Techalloy® 99	99	0.02	0.1	<0.50	

TYPICAL OPERATING PROCEDURES

Process / Polarity	Diameter in (mm)	Voltage (volts)	Amperage	Gas
MIG / DC+	0.035 (0.9)	24-27	150-190	75% Argon / 25% Helium
	0.045 (1.1)	25-30	200-290	

⁽¹⁾See test results disclaimer.
Safety Data Sheets (SDS) are available on our website at www.lincolnelectric.com

TECHALLOY® 208

Nickel · AWS ERNi-1

KEY FEATURES

- High nickel alloy with Al and Ti for sound deposits
- Q2 Lot® - Certificate showing actual wire composition available online

WELDING POSITIONS

All

SHIELDING GAS

MIG 75% Ar / 25% He

TIG 100% Ar

CONFORMANCES

AWS A5.14: ERNi-1

ASME SFA-5.14: ERNi-1

CWB/CSA: ERNi-1

TYPICAL APPLICATIONS

- For MIG and TIG welding of nickel 200 and 201
- Can be used for overlay on steel as well as repairing cast iron castings
- Used for dissimilar joints between nickel or nickel alloys to stainless or ferritic steels

DIAMETERS / PACKAGING

Diameter in (mm)	MIG 33 lb (15 kg) Steel Spool	MIG 250 lb (113 kg) Accu-Trak Drum	TIG 10 lb (4.5 kg) Tube 30 lb (13.6 kg) Master Carton
0.035 (0.9)	MG208035667	MG208035684	
0.045 (1.1)	MG208045667		
1/16 (1.6)	MG208062667		TG208062638
3/32 (2.4)			TG208093638
1/8 (3.2)			TG208125638

WIRE COMPOSITION - As Required per AWS A5.14M

	%C	%Mn	%Fe	%P	%S	%Si
Requirements						
AWS ERNi-1	0.15 max	1.0 max	1.0 max	0.03 max	0.015 max	0.75 max
Typical Results⁽¹⁾						
Techalloy® 208	0.05	0.3	0.1	0.004	0.002	0.3
	%Cu	%Ni	%Al	%Ti	%Other	
Requirements						
AWS ERNi-1	0.25 max	93.0 min	1.5 max	2.0 - 3.5	0.50 max	
Typical Results⁽¹⁾						
Techalloy® 208	0.02	97.0	0.1	2.8	<0.50	

TYPICAL OPERATING PROCEDURES

Process/Polarity	Diameter in (mm)	Voltage (volts)	Amperage	Gas
MIG / DC+	0.035 (0.9)	24-29	180-200	75% Argon / 25% Helium
	0.045 (1.1)	26-30	250-270	
	1/16 (1.6)	29-33	200-250	

⁽¹⁾See test results disclaimer.

Safety Data Sheets (SDS) are available on our website at www.lincolnelectric.com

TECHALLOY® 276

Nickel · AWS ERNiCrMo-4

KEY FEATURES

- Used for welding materials of similar composition
- Due to high molybdenum content, this alloy offers excellent resistance to stress corrosion cracking, pitting and crevice corrosion
- Q2 Lot® - Certificate showing actual wire composition available online

WELDING POSITIONS

All

RECOMMENDED FLUXES

SAW P2007, P2000

CONFORMANCES

AWS A5.14: ERNiCrMo-4
 ASME SFA-5.14: ERNiCrMo-4
 CWB/CSA: ERNiCrMo-4

TYPICAL APPLICATIONS

- Low carbon, nickel-chromium-molybdenum filler metal can also be used for dissimilar welding between nickel base alloys and stainless steels for cladding
- Used in LNG applications

SHIELDING GAS

MIG 75% Ar / 25% He
 TIG 100% Ar

DIAMETERS / PACKAGING

Diameter in (mm)	MIG 33 lb (15 kg) Steel Spool	MIG 250 lb (113.4 kg) Accu-Trak® Drum	TIG 10 lb (4.5 kg) Tube 30 lb (13.6 kg) Master Carton	SAW 55 lb (25 kg) Steel Spool
0.035 (0.9)	MG276035667	MG276035684		
0.045 (1.1)	MG276045667			
1/16 (1.6)	MG276062667		TG276062638	
3/32 (2.4)			TG276093638	SA276093726
1/8 (3.2)			TG276125638	SA276125726
5/32 (4.0)			TG276156638	

WIRE COMPOSITION - As Required per AWS A5.14M

	%C	%Mn	%Fe	%P	%S	%Si	%Cu
Requirements AWS ERNiCrMo-4	0.02 max	1.0 max	4.0 - 7.0	0.04 max	0.03 max	0.08 max	0.50 max
Typical Results⁽¹⁾ Techalloy® 276	0.01	0.5	5.8	0.01	0.002	0.01	0.01
	%Ni	%Co	%Cr	%Mo	%V	%W	%Other
Requirements AWS ERNiCrMo-4	Remainder	2.5 max	14.5 - 16.5	15.0 - 17.0	0.35 max	3.0 - 4.5	0.50 max
Typical Results⁽¹⁾ Techalloy® 276	58.0	0.07	15.5	16.0	0.04	4.0	<0.50

TYPICAL OPERATING PROCEDURES

Process / Polarity	Diameter in (mm)	Voltage (volts)	Amperage	Gas / Flux
MIG / DC+	0.035 (0.9)	26-29	150-190	75% Argon / 25% Helium
	0.045 (1.1)	28-32	180-220	
	1/16 (1.6)	29-33	200-250	
SAW / DC+	3/32 (2.4)	28-30	275-350	Lincolnweld® P2007
	1/8 (3.2)	29-32	350-450	

⁽¹⁾See test results disclaimer.

Safety Data Sheets (SDS) are available on our website at www.lincolnelectric.com

TECHALLOY® 413

Nickel · AWS ERCuNi

KEY FEATURES

- This filler metal can be used for MIG overlay on steel after a first layer with Nickel 208
- Preheating is generally not required for this product
- Q2 Lot® -Certificate showing actual wire composition available online

WELDING POSITIONS

All

CONFORMANCES

AWS A5.7:	ERCuNi
ASME SFA-5.7:	ERCuNi
CWB/CSA:	ERCuNi
ABS:	ERCuNi

TYPICAL APPLICATIONS

- Used for MIG and TIG of 70/30, 80/20 and 90/10 copper-nickel alloys

SHIELDING GAS

MIG 75% Ar / 25% He
TIG 100% Ar

DIAMETERS / PACKAGING

Diameter in (mm)	MIG 33 lb (15 kg) Steel Spool	TIG 10 lb (4.5 kg) Tube 30 lb (13.6 kg) Master Carton
0.035 (0.9)	MG413035667	
0.045 (1.1)	MG413045667	
1/16 (1.6)	MG413062667	TG413062638
3/32 (2.4)		TG413093638
1/8 (3.2)		TG413125638

WIRE COMPOSITION - As Required per AWS A5.7

	%Cu	%Mn	%Fe	%Si	%Ni
Requirements AWS ERCuNi	Remainder	1.0 max	0.40 - 0.75	0.25 max	29 - 32
Typical Results⁽¹⁾ Techalloy® 413	67.5	0.7	0.55	0.1	30
	%P	%Pb	%Ti	%Other	
Requirements AWS ERCuNi	0.02 max	0.02 max	0.20 - 0.50	0.50 max	
Typical Results⁽¹⁾ Techalloy® 413	0.006	0.003	0.25	<0.50	

TYPICAL OPERATING PROCEDURES

Process / Polarity	Diameter in (mm)	Voltage (volts)	Amperage	Gas
MIG / DC+	0.035 (0.9)	25-29	150-190	75% Argon / 25% Helium
	0.045 (1.1)	25-28	180-240	
	1/16 (1.6)	29-33	200-250	

⁽¹⁾See test results disclaimer.
Safety Data Sheets (SDS) are available on our website at www.lincolnelectric.com

TECHALLOY® 418

Nickel · AWS ERNiCu-7

KEY FEATURES

- Used for MIG, TIG and SAW welding of copper alloys
- Dissimilar welding applications include joining Nickel 200 to copper-nickel alloys
- Q2 Lot® -Certificate showing actual wire composition available online

WELDING POSITIONS

All

RECOMMENDED FLUXES

SAW P2000

CONFORMANCES

AWS A5.14: ERNiCu-7

ASME SFA-5.14: ERNiCu-7

CWB/CSA: ERNiCu-7

TYPICAL APPLICATIONS

Marine

SHIELDING GAS

MIG 75% Ar / 25% He

TIG 100% Ar

DIAMETERS / PACKAGING

Diameter in (mm)	MIG 33 lb (15 kg) Steel Spool	MIG 250 lb (113.4 kg) Accu-Trak® Drum	TIG 10 lb (4.5 kg) Tube 30 lb (13.6 kg) Master Carton	SAW 55 lb (25 kg) Steel Spool
0.035 (0.9)	MG418035667	MG208035684		
0.045 (1.1)	MG418045667			
1/16 (1.6)	MG418062667		TG418062638	
3/32 (2.4)			TG418093638	SA418093726
1/8 (3.2)			TG418125638	SA418125726

WIRE COMPOSITION - As Required per AWS A5.14M

	%C	%Mn	%Fe	%P	%S	%Si
Requirements AWS ERNiCu-7	0.15 max	4.0 max	2.5 max	0.02 max	0.015 max	1.25 max
Typical Results⁽¹⁾ Techalloy® 418	0.07	3.0	0.1	0.002	0.002	0.31
	%Cu	%Ni	%Al	%Ti	%Others	
Requirements AWS ERNiCu-7	Remainder	62.0 - 69.0	1.25 max	1.5 - 3.0	0.50 max	
Typical Results⁽¹⁾ Techalloy® 418	30	64	0.15	1.8	<0.50	

TYPICAL OPERATING PROCEDURES

Process / Polarity	Diameter in (mm)	Voltage (volts)	Amperage	Gas / Flux
MIG / DC+	0.035 (0.9)	25-28	160-200	75% Argon / 25% Helium
	0.045 (1.1)	26-30	190-230	
	1/16 (1.6)	29-33	200-250	
SAW / DC+	3/32 (2.4)	28-30	275-350	Lincolnweld® P2000
	1/8 (3.2)	29-32	350-450	

⁽¹⁾See test results disclaimer.

Safety Data Sheets (SDS) are available on our website at www.lincolnelectric.com

TECHALLOY® 606

Nickel · AWS ERNiCr-3

KEY FEATURES

- Used for MIG, TIG and SAW welding of base materials such as ASTM B163, B166, B167 and B168 alloys which have UNS Number N06600
- Suitable for applications ranging from cryogenic to high temperatures making this alloy one of the most used in the nickel family
- Q2 Lot® - Certificate showing actual wire composition available online

WELDING POSITIONS

All

RECOMMENDED FLUXES

SAW P2000

CONFORMANCES

AWS A5.14: ERNiCr-3
ASME SFA-5.14: ERNiCr-3
CWB/CSA: ERNiCr-3

TYPICAL APPLICATIONS

- This filler metal can also be used for dissimilar welding applications between various nickel alloys and stainless or carbon steels, as well as for overlay

SHIELDING GAS

MIG 75% Ar / 25% He
TIG 100% Ar

DIAMETERS / PACKAGING

Diameter in (mm)	MIG 33 lb (15 kg) Steel Spool	TIG 10 lb (4.5 kg) Tube 30 lb (13.6 kg) Master Carton	SAW 55 lb (25 kg) Steel Spool
0.035 (0.9)	MG606035667		
0.045 (1.1)	MG606045667		
1/16 (1.6)	MG606062667	TG606062638	
3/32 (2.4)		TG606093638	SA606093726
1/8 (3.2)		TG606125638	SA606125726
5/32 (4.0)		TG606156638	

WIRE COMPOSITION - As Required per AWS A5.14M

	%C	%Mn	%Fe	%P	%S	%Si
Requirements AWS ERNiCr-3	0.10 max	2.5 - 3.5	3.0 max	0.03 max	0.015	0.50 max
Typical Results⁽¹⁾ Techalloy® 606	0.04	2.8	1.5	0.003	0.002	0.09
	%Cu	%Ni	%Ti	%Cr	%Nb + Ta	%Others
Requirements AWS ERNiCr-3	0.50 max	670 min	0.75 max	18.0 - 22.0	2.0 - 3.0	0.50 max
Typical Results⁽¹⁾ Techalloy® 606	0.03	73.0	0.40	20.0	2.4	<0.50

TYPICAL OPERATING PROCEDURES

Process / Polarity	Diameter in (mm)	Voltage (volts)	Amperage	Gas / Flux
MIG / DC+	0.035 (0.9)	26-29	150-190	75% Argon / 25% Helium
	0.045 (1.1)	28-32	180-220	
	1/16 (1.6)	29-33	200-250	
SAW / DC+	3/32 (2.4)	28-30	275-350	Lincolnweld® P2000
	1/8 (3.2)	29-32	350-450	

⁽¹⁾See test results disclaimer.
 Safety Data Sheets (SDS) are available on our website at www.lincolnelectric.com

TECHALLOY® 617

Nickel · AWS ERNiCrCoMo-1

KEY FEATURES

- The weld metal provides optimum strength and oxidation resistance from 1500°F (815°C) up to 2100°F (1150°C)
- Q2 Lot* - Certificate showing actual wire composition available online

WELDING POSITIONS

All

RECOMMENDED FLUXES

SAW P2000

CONFORMANCES

AWS A5.14:	ERNiCrCoMo-1
ASME SFA-5.14:	ERNiCrCoMo-1
CWB/CSA:	ERNiCrCoMo-1

TYPICAL APPLICATIONS

- Used for MIG, TIG and SAW welding of nickel-chrome-cobalt-molybdenum alloys

SHIELDING GAS

MIG 75% Ar / 25% He
TIG 100% Ar

DIAMETERS / PACKAGING

Diameter in (mm)	MIG 33 lb (15 kg) Steel Spool	TIG 10 lb (4.5 kg) Tube 30 lb (13.6 kg) Master Carton	SAW 55 lb (25 kg) Steel Spool
0.035 (0.9)	MG617035667		
0.045 (1.1)	MG617045667		
1/16 (1.6)	MG617062667	TG617062638	
3/32 (2.4)		TG617093638	
1/8 (3.2)		TG617125638	SA617125726
5/32 (4.0)		TG617156638	

WIRE COMPOSITION - As Required per AWS A5.14M

	%C	%Mn	%Fe	%P	%S	%Si	%Cu
Requirements AWS ERNiCrCoMo-1	0.05 - 0.15	1.0 max	3.0 max	0.03 max	0.015 max	1.0 max	0.50 max
Typical Results ⁽¹⁾ Techalloy® 617	0.07	0.4	0.3	0.001	0.003	0.3	0.09
	%Ni	%Co	%Al	%Ti	%Cr	%Mo	%Other
Requirements AWS ERNiCrCoMo-1	Remainder	10.0 - 15.0	0.8 - 1.5	0.60 max	20.0 - 24.0	8.0 - 10.0	0.50 max
Typical Results ⁽¹⁾ Techalloy® 617	54	12.0	1.0	0.4	22.0	8.7	<0.50

TYPICAL OPERATING PROCEDURES

Process / Polarity	Diameter in (mm)	Voltage (volts)	Amperage	Gas / Flux
MIG / DC+	0.035 (0.9)	26-29	150-190	75% Argon / 25% Helium
	0.045 (1.1)	28-32	180-220	
	1/16 (1.6)	29-33	200-250	
SAW / DC+	1/8 (3.2)	29-32	350-450	Lincolnweld® P2000

⁽¹⁾See test results disclaimer.

Safety Data Sheets (SDS) are available on our website at www.lincolnelectric.com

TECHALLOY® 622

Nickel · AWS ERNiCrMo-10

KEY FEATURES

- Excellent corrosion resistance in oxidizing as well as reducing media in a wide variety of chemical process environments
- Outstanding resistance to stress corrosion cracking, pitting and crevice corrosion
- Q2 Lot® - Certificate showing actual wire composition available online

WELDING POSITIONS

All

RECOMMENDED FLUXES

SAW P2000

CONFORMANCES

AWS A5.14:	ERNiCrMo-10
ASME SFA-5.14: AWS A5.14:	ERNiCrMo-10
CWB/CSA:	ERNiCrMo-10

TYPICAL APPLICATIONS

- A nickel based alloy with chromium, molybdenum, and tungsten as the principal alloying elements
- Used for cladding overlay as well as thermal spray applications

SHIELDING GAS

MIG 75% Ar / 25% He
TIG 100% Ar

DIAMETERS / PACKAGING

Diameter in (mm)	MIG 33 lb (15 kg) Steel Spool	TIG 10 lb (4.5 kg) Tube 30 lb (13.6 kg) Master Carton	SAW 55 lb (25 kg) Steel Spool
0.035 (0.9)	MG622035667		
0.045 (1.1)	MG622045667		
1/16 (1.6)	MG622062667	TG622062638	
3/32 (2.4)		TG622093638	SA622093726
1/8 (3.2)		TG622125638	

WIRE COMPOSITION - As Required per AWS A5.14M

	%C	%Mn	%Fe	%P	%S	%Si	%Cu
Requirements AWS ERNiCrMo-10	0.015 max	0.50 max	2.0 - 6.0	0.02 max	0.010 max	0.08 max	0.50 max
Typical Results⁽¹⁾ Techalloy® 622	0.01	0.14	4.4	0.003	0.002	0.07	0.01
	%Ni	%Co	%Cr	%Mo	%V	%W	%Other
Requirements AWS ERNiCrMo-10	Remainder	2.50 max	20.0 - 22.5	12.5 - 14.5	0.35 max	2.5 - 3.5	0.50 max
Typical Results⁽¹⁾ Techalloy® 622	56	0.1	21.4	13.8	0.02	3.1	<0.50

TYPICAL OPERATING PROCEDURES

Process / Polarity	Diameter in (mm)	Voltage [volts]	Amperage	Gas / Flux
MIG / DC+	0.035 (0.9)	26-29	140-190	75% Argon / 25% Helium
	0.045 (1.1)	28-32	160-200	
	1/16 (1.6)	29-33	200-250	
SAW / DC+	3/32 (2.4)	28-30	275-350	Lincolnweld® P2000

⁽¹⁾See test results disclaimer.

Safety Data Sheets (SDS) are available on our website at www.lincolnelectric.com

TECHALLOY® 625

Nickel · AWS ERNiCrMo-3

KEY FEATURES

- Designed to match the composition and properties of Alloy 625
- The Ni-Cr-Mo alloy system provides excellent resistance to oxidizing and reducing environments
- The high molybdenum content provides good stress, pitting and crevice corrosion resistance
- Most popular nickel alloy for cladding
- Provides high temperature strength and structural stability
- Q2 Lot® - Certificate showing actual wire composition available online

WELDING POSITIONS

All

RECOMMENDED FLUXES

SAW P2000

DIAMETERS / PACKAGING

Diameter in (mm)	MIG 33 lb (15 kg) Steel Spool	MIG 250 lb (113.4 kg) Accu-Trak® Drum	MIG 300 lb (136 kg) Speed-Feed® Reel	Hot Wire TIG 33 lb (15 kg)	Hot Wire TIG 250 lb (113.4 kg)	TIG 10 lb (4.5 kg) Tube 30 lb (13.6 kg) Master Carton	SAW 60 lb (27 kg) Fiber Spool	SAW 55 lb (25 kg) Steel Spool	SAW 500 lb (227 kg) Speed Feed® Drum
0.035 (0.9)	MG625035667				MG625HWT035684				
0.045 (1.1)	MG625045667	MG625045684		MG625HWT045667	MG625HWT04568				
1/16 (1.6)	MG625062667		MG625062693			TG625062638	SA625062679		
3/32 (2.4)						TG625093638		SA625093726	SA625093692
1/8 (3.2)						TG625125638		SA625125726	SA625125692
5/32 (4.0)						TG625156638			SA625156692

CONFORMANCES

AWS A5.14:	ERNiCrMo-3
ASME SFA-5.14:	ERNiCrMo-3
ISO:	S Ni 6625 (NiCr22Mo9Nb)
ABS:	ERNiCrMo-3
CWB/CSA:	ERNiCrMo-3

TYPICAL APPLICATIONS

- Used for MIG, TIG and SAW welding of nickel-chromium-molybdenum alloys
- This filler metal may be used for cladding and welding dissimilar base metals such as Ni-Cr-Mo alloys to stainless and carbon steels

SHIELDING GAS

MIG 75% Ar / 25% He
TIG 100% Ar

WIRE COMPOSITION - As Required per AWS A5.14M

	%C	%Mn	%Fe	%P	%S	%Si	%Cu
Requirements AWS ERNiCrMo-3	0.10 max	0.50 max	5.0 max	0.02 max	0.015 max	0.50 max	0.50 max
Typical Results⁽¹⁾ Techalloy® 625	0.02	0.1	0.4	0.005	0.001	0.14	0.01
	%Ni	%Al	%Ti	%Cr	%Nb+Ta	%Mo	%Other
Requirements AWS ERNiCrMo-3	58.0 min	0.40 max	0.40 max	20.0 - 23.0	3.15 - 4.15	8.0 - 10.0	0.50 max
Typical Results⁽¹⁾ Techalloy® 625	64	0.1	0.17	21.7	3.8	8.5	<0.50

TYPICAL OPERATING PROCEDURES

Process / Polarity	Diameter in (mm)	Voltage (volts)	Amperage	Gas / Flux
MIG / DC+	0.035 (0.9)	26-29	150-190	75% Argon / 25% Helium
	0.045 (1.1)	28-32	180-220	
	1/16 (1.6)	29-33	200-250	
SAW / DC+	3/32 (2.4)	28-30	275-350	Lincolnweld® P2000
	1/8 (3.2)	29-33	350-450	

⁽¹⁾See test results disclaimer.

Safety Data Sheets (SDS) are available on our website at www.lincolnelectric.com

TECHALLOY® 686

Nickel · AWS ERNiCrMo-14

KEY FEATURES

- Used for TIG, MIG and SAW welding of base materials such as ASTM B574, B575, B619, B622, and B628 having a UNS number of N06686
- Suitable for highly acidic and high heat environments
- Q2 Lot® - Certificate showing actual wire composition available online

WELDING POSITIONS

All

RECOMMENDED FLUX

SAW P2000

CONFORMANCES

AWS A5.14	ERNiCrMo-14
ASME SFA-5.14:	ERNiCrMo-14
CWB/CSA:	ERNiCrMo-14

TYPICAL APPLICATIONS

- Typically used in pollution control (flue gas desulfurization), chemical processing, power generation, pulp and paper manufacturing and waste management

SHIELDING GAS

MIG	75% Ar / 25% He, 100% Ar
TIG	100% Ar

DIAMETERS / PACKAGING

Diameter in (mm)	MIG 33 lb (15 kg) Steel Spool	TIG 10 lb (4.5 kg) Tube 30 lb (13.6 kg) Master Carton	SAW 55 lb (25 kg) Steel Spool
0.035 (0.9)	MG686035667		
0.045 (1.1)	MG686045667		
1/16 (1.6)	MG686062667	TG686062638	
3/32 (2.4)		TG686093638	SA686093726
1/8 (3.2)		TG686125638	SA686125726

WIRE COMPOSITION⁽¹⁾ – As Required per AWS A5.14M: 2018

	%C	%Mn	%Fe	%P	%S	%Si
Requirements AWS ERNiCrMo-14	0.01	1.0	5.0	0.02	0.02	0.08
	%Mo	%Ni	%Ti	%Cr	%W	
Requirements AWS ERNiCrMo-14	15.0-17.0	Balance	0.25	19.0-23.0	3.0-4.4	

TYPICAL OPERATING PROCEDURES

Process / Polarity	Diameter in (mm)	WFS	Voltage (volts)	Current (Amps)	Gas / Flux
MIG / DC+	0.035 (0.9) 0.045 (1.1)	400-600 350-450	27-30 29-32	150-190 240-300	75% Ar / 25% He
SAW / DC+	3/32 (2.4) 1/8 (3.2)		28-30 29-33	275-350 350-450	Lincolnweld® P2000

⁽¹⁾Typical deposit composition
Safety Data Sheets (SDS) are available on our website at www.lincolnelectric.com

TECHALLOY® 718

Nickel · AWS ERNiFeCr-2

KEY FEATURES

- This alloy can be age hardened to higher strengths
- Q2 Lot® - Certificate showing actual wire composition available online

WELDING POSITIONS

All

SHIELDING GAS

MIG 75% Ar / 25% He

TIG 100% Ar

CONFORMANCES

AWS A5.14: ERNiFeCr-2

ASME SFA-5.14: ERNiFeCr-2

CWB/CSA: ERNiFeCr-2

TYPICAL APPLICATIONS

- Used for welding alloys 718, 706 and X-750
- Mainly used for welding high strength aircraft components and liquid rocket components involving cryogenic temperatures

DIAMETERS / PACKAGING

Diameter in (mm)	MIG 33 lb (15 kg) Steel Spool	TIG 10 lb (4.5 kg) Tube 30 lb (13.6 kg) Master Carton
0.035 (0.9)	MG718035667	
0.045 (1.1)	MG718045667	
1/16 (1.6)	MG718062667	
3/32 (2.4)		TG718093638
1/8 (3.2)		TG718125638

WIRE COMPOSITION - As Required per AWS A5.14M

	%C	%Mn	%Fe	%P	%S
Requirements AWS ERNiFeCr-2	0.08 max	0.35 max	Remainder	0.015 max	0.015 max
Typical Results⁽¹⁾ Techalloy® 718	0.05	0.10	20	0.01	0.001
	%Si	%Cu	%Ni	%Al	%Ti
Requirements AWS ERNiFeCr-2	0.35 max	0.30 max	50.0 - 55.0	0.20 - 0.80	0.65 - 1.15
Typical Results⁽¹⁾ Techalloy® 718	0.06	0.01	53	0.45	1.0
	%Cr	%Nb + Ta	%Mo	%Other	
Requirements AWS ERNiFeCr-2	17.0 - 21.0	4.75 - 5.50	2.80 - 3.30	0.50 max	
Typical Results⁽¹⁾ Techalloy® 718	17.4	5.0	3.0	<0.50	

TYPICAL OPERATING PROCEDURES

Process / Polarity	Diameter in (mm)	Voltage (volts)	Amperage	Gas
MIG / DC+	0.035 (0.9)	26-29	150-190	75% Argon / 25% Helium
	0.045 (1.1)	28-32	180-220	
	1/16 (1.6)	29-33	200-250	

⁽¹⁾See test results disclaimer.

Safety Data Sheets (SDS) are available on our website at www.lincolnelectric.com

TECHALLOY® 825

Nickel · AWS ERNiFeCr-1

KEY FEATURES

- Used for MIG and TIG welding of nickel-chromium-molybdenum-copper alloys
- Can be used to overlay cladding where similar chemical composition is required
- Q2 Lot® - Certificate showing actual wire composition available online

WELDING POSITIONS

All

CONFORMANCES

AWS A5.14:	ERNiFeCr-1
ASME SFA-5.14:	ERNiFeCr-1
CWB/CSA:	ERNiFeCr-1
ABS:	ERNiFeCr-1

TYPICAL APPLICATIONS

- Used for welding the nickel-iron-chromium-molybdenum-copper alloy (ASTM B 423 having UNS number N08825) to itself ²⁾

SHIELDING GAS

MIG 75% Ar / 25% He
TIG 100% Ar

DIAMETERS / PACKAGING

Diameter in (mm)	MIG 33 lb (15 kg) Steel Spool	TIG 10 lb (4.5 kg) Tube 30 lb (13.6 kg) Master Carton
0.035 (0.9)	MG825035667	
0.045 (1.1)	MG825045667	
1/16 (1.6)	MG825062667	TG825062638
3/32 (2.4)		TG825093638
1/8 (3.2)		TG825125638

WIRE COMPOSITION - As Required per AWS A5.14M

	%C	%Mn	%Fe	%P	%S	%Si	%Cu
Requirements AWS ERNiFeCr-1	0.05 max	1.0 max	22.0 min	0.03 max	0.03 max	0.50 max	1.5 - 3.0
Typical Results⁽¹⁾ Techalloy® 825	0.01	0.01	27	0.02	0.002	0.2	2.1
	%Ni	%Al	%Ti	%Cr	%Mo	%Other	
Requirements AWS ERNiFeCr-1	38.0 - 46.0	0.20 max	0.6 - 1.2	19.5 - 23.5	2.5 - 3.5	0.50 max	
Typical Results⁽¹⁾ Techalloy® 825	42.0	0.8	0.8	22.1	3.0	<0.50	

TYPICAL OPERATING PROCEDURES

Process / Polarity	Diameter in (mm)	Voltage (volts)	Amperage	Gas
MIG / DC+	0.035 (0.9)	26-29	150-190	75% Argon / 25% Helium
	0.045 (1.1)	28-32	180-220	
	1/16 (1.6)	29-33	200-250	

⁽¹⁾See test results disclaimer. ⁽²⁾Extracted from AWS A5.14/A5.14M Section A25.1.
Safety Data Sheets (SDS) are available on our website at www.lincolnelectric.com

TECHALLOY® X

Nickel · AWS ERNiCrMo-2

KEY FEATURES

- The Ni-Cr-Mo alloy system provides excellent resistance to oxidizing and reducing environments
- Meets AMS 5798G chemical and tolerance requirements
- Q2 Lot® -Certificate showing actual wire composition available online

WELDING POSITIONS

All

CONFORMANCES

AWS A5.14: ERNiCrMo-2
ASME SFA-5.14: ERNiCrMo-2

TYPICAL APPLICATIONS

- Used for MIG and TIG welding of nickel-chromium-molybdenum alloys

SHIELDING GAS

MIG 75% Ar / 25% He or 100% Ar
TIG 100% Ar

DIAMETERS / PACKAGING

Diameter in (mm)	MIG 33 lb (14.9 kg) Wire Basket	TIG 10 lb (4.5 kg) Tube 30 lb (13.6 kg) Master Carton
0.035 (0.9)	MGX035667	
0.045 (1.1)	MGX045667	
1/16 (1.6)		TGX062638
3/32 (2.4)		TGX093638
1/8 (3.2)		TGX125638

WIRE COMPOSITION - As Required per AWS A5.14

	%C	%Mn	%Si	%S	%P	%Cr	%Ni
Requirements							
AWS ERNiCrMo-2	0.05 - 0.15	1.0 max	1.0 max	0.03 max	0.04 max	20.5 - 23.0	remainder
Typical Results⁽¹⁾	0.10	0.03	0.10	<0.001	0.01	21.7	48
	%Mo	%Cu	%Fe	%Co	%W	Other Elements, Total %	
Requirements							
AWS ERNiCrMo-2	8.0 - 10.0	0.50 max	17.0 - 20.0	0.5 - 2.5	0.2 - 1.0	0.50 max	
Typical Results⁽¹⁾	9.3	0.01	18.6	1.9	0.6	<0.50	

⁽¹⁾See test results disclaimer

SUPERCORE® 625P

Nickel · AWS ENiCrMo3T1-4

KEY FEATURES

- Smooth all position weldability
- Vacuum sealed foil package
- Excellent slag removal
- Q2 Lot® - Certificate showing actual deposit composition available online

WELDING POSITIONS

All

SHIELDING GAS

75-80% Argon / Balance CO₂
100% CO₂

CONFORMANCES

AWS A5.34:	ENiCrMo3T1-4
UNS	W86625
ISO 12153	T Ni 6625 P M/C 2

TYPICAL APPLICATIONS

- Furnace Equipment
- Petrochemical
- 9% Ni for LNG storage tanks
- Dissimilar welds between Nickel alloys, stainless steels, and mild steel

DIAMETERS / PACKAGING

Diameter mm (in)	15 kg (33 lb) Spool
1.2 (0.045)	SC625P-12

MECHANICAL PROPERTIES⁽¹⁾ - As Required per AWS A5.34

	Yield Strength ⁽²⁾ MPa (ksi)	Tensile Strength MPa (ksi)	Elongation %	Charpy V-Notch J (ft-lbf) @ 20°C (68°F)
Requirements AWS ENiCrMo3T1-4	—	690 min (100)	25 min	—
Typical Results⁽³⁾ As-Welded	500 (72)	770 (112)	46	95 (70)

DEPOSIT COMPOSITION - As Required per AWS A5.34

	%C	%Mn	%Si	%S	%P	%Cr
Requirements AWS ENiCrMo3T1-4	0.10 max	0.50 max	0.50 max	0.015 max	0.02 max	20.0 - 23.0
Typical Results⁽³⁾	0.02	0.3	0.2	0.005	0.005	21
	%Ni	%Mo	%Nb	%Cu	%Ti	%Fe
Requirements AWS ENiCrMo3T1-4	58.0 min	8.0 - 10.0	3.15 - 4.15	0.50 max	0.40 max	5.0 max
Typical Results⁽³⁾	66	8.5	3.4	0.02	0.2	1.0

TYPICAL OPERATING PROCEDURES

Diameter / Polarity mm (in) / DC+	Voltage (volts)	Amperage	Typical	Stickout in (mm)
1.2 (0.047) DC+	25 - 28V	150 - 180A	160A, 26V	5/8-1 (15-20 mm)

⁽¹⁾Typical deposit composition. ⁽²⁾Measured with 0.2% offset. ⁽³⁾See test results disclaimer
NOTE: Additional test data available upon request.

CONSUMABLES

HARDFACING



BUILD UP AND JOINING**Carbon or Manganese Steel**

Blue Max® 2100 [SMAW]..... H-12

Carbon Steel

Wearshield® BU [SMAW]..... H-1

Lincore® BU [FCAW-S] H-37

Lincore® BU-G [GMAW-C] H-36

Lincore® 20 SAW-C H-23

Lincore® 8620 SAW-C H-26

Lincolnweld® H-535™ SAW FLUX..... H-57

Manganese Steel

Wearshield® FROG MANG® SMAW..... H-5

Wearshield® 15CrMn SMAW..... H-4

Wearshield® Mangjet® SMAW..... H-3

Lincore® FROG MANG® FCAW-S H-44

Lincore® 15CrMn FCAW-S H-43

Lincore® M FCAW-S H-42

**METAL TO EARTH (EARTH CUTTING & DIGGING)
FOR EXTREME ABRASION AND LOW TO
MODERATE IMPACT**

Wearshield® 60 SMAW..... H-10

Lincoln® SHS® 9700E SMAW..... H-11

Lincore® 60-0 FCAW-S H-47

Lincore® 70-0 FCAW-S H-50

Lincoln® SHS® 9192U FCAW-S H-55

Lincoln® SHS® 9500U FCAW-S H-56

Lincoln® SHS® 9700U FCAW-S H-54

Lincoln® SHS® 9800U FCAW-S H-53

Lincore® 60-G GMAW-C H-14

Lincore® 70-G GMAW-C H-15

Lincoln® SHS® 7570W ARC SPRAY..... H-62

Lincoln® SHS® 8000W ARC SPRAY..... H-63

Lincoln® SHS® 9172W ARC SPRAY..... H-64

Lincoln® SHS® 7574HV SPRAY POWDER..... H-65

Lincoln® SHS® 8000HV SPRAY POWDER..... H-66

Lincoln® SHS® 9172HV SPRAY POWDER..... H-67

Lincoln® SHS® 9294P PTAW POWDER..... H-68

Lincoln® SHS® 9700P PTAW POWDER..... H-69

**METAL TO EARTH FOR MODERATE TO SEVERE
IMPACT & MODERATE TO SEVERE ABRASION**

Wearshield® 44 SMAW..... H-8

Wearshield® ABR SMAW..... H-7

Wearshield® ME SMAW..... H-9

Lincore® 50 FCAW-S H-46

Lincore® 65 Plus FCAW-S H-52

Lincore® 65-0 FCAW-S H-49

Lincore® TiCore FCAW-S H-51

Lincore® Ultra K FCAW-S H-48

Lincolnweld® H-560™ SAW FLUX..... H-58

METAL TO METAL OR METAL TO EARTH ABRASION

Lincore® 55 FCAW-S H-40

Lincore® 55-G GMAW-C H-17

Lincore® 57-G GMAW-C H-13

METAL TO METAL WEAR

Wearshield® MI SMAW..... H-2

Wearshield® Super Rail™ SMAW..... H-6

Lincore® 33 FCAW-S H-38

Lincore® 40-0 FCAW-S H-39

Lincore® Super Rail™ FCAW-S H-45

Lincore® T & D FCAW-S H-41

Lincore® M7-G GMAW-C H-16

Lincoln® Guardian® CF GMAW-C H-61

Lincoln® Guardian® HB GMAW-C H-60

Lincore® 102HC SAW H-35

Lincore® 102W SAW H-34

Lincore® 30-S SAW H-18

Lincore® 32-S SAW H-19

Lincore® 35-S	SAW	H-20
Lincore® 40-S	SAW	H-21
Lincore® 410	SAW	H-27
Lincore® 410NiMo	SAW	H-28
Lincore® 4130	SAW	H-25
Lincore® 414N	SAW	H-32
Lincore® 420	SAW	H-31
Lincore® 420HC-S	SAW	H-24
Lincore® 423Cr	SAW	H-30
Lincore® 423L	SAW	H-29
Lincore® 423N	SAW	H-32
Lincore® 42-S	SAW	H-22
Lincore® 96-S	SAW	H-33
Lincolnweld® 801®	SAW FLUX.....	H-59
Lincolnweld® 802®	SAW FLUX.....	H-59
Lincolnweld® A-96-S	SAW FLUX.....	H-57

WEARSHIELD® BU

Build-up and Joining

KEY FEATURES

- Build-up with moderate hardness to resist shock and metal-to-metal wear, as in rolling and sliding
- Can be used as underbase for other hardfacing deposits or as final overlay on parts to be machined or forged
- Unlimited layers with proper preheat, interpass temperatures and procedures
- Use on mild and low alloy steels

TYPICAL APPLICATIONS

For Build-Up

- Shovel and bucket lips
- Pump impellers and housings
- Pulverizer plows
- Mill hammers

For Hardfacing

- Trunnions, tractor rolls, cranes and gears

WELDING POSITIONS

Flat & Horizontal

DIAMETERS / PACKAGING

Diameter in (mm)	Length in (mm)	10 lb (4.5 kg) Plastic Tube
5/32 (4.0)	14 (350)	ED021991
3/16 (4.8)	14 (350)	ED021993

MECHANICAL PROPERTIES⁽¹⁾

1 Layer	Rockwell Hardness (R _c)	
	2 Layers	3 Layers
15-20	18-23	23-28

DEPOSIT COMPOSITION⁽¹⁾

	%C	%Mn	%Si	%Cr	%S	%P
2 or more layers	0.14	1.15	0.60	1.40	0.025	0.015

TYPICAL OPERATING PROCEDURES

Polarity ⁽²⁾	Current (Amps)	
	5/32 in (4.0 mm)	3/16 in (4.8 mm)
DC+	145-210	180-280
AC	155-225	200-290

⁽¹⁾Composition and properties depend upon dilution. Single layer deposit properties depend upon base metal and/or build-up material. ⁽²⁾Preferred polarity is listed first.

NOTE: Using a short arc with a slight weave motion, deposit beads about 1/2 in - 3/4 in (13-19 mm) wide with the 5/32 in and 3/16 in (4.0-4.8 mm) electrode diameters, and about 1 in (25 mm) wide with the 1/4 in (6.4 mm) diameter. However, on edges and corners, fast-moving stringer beads or very narrow weaved beads are usually preferred. The exact width and thickness of the bead will depend on the mass of the piece being welded.

Work-hardened base or weld metal should be removed before applying Wearshield® BU, since such areas are more prone to embrittlement and possible cracking. The part should be preheated to at least 21°C (70°F). Preheating above 40°C (100°F) is usually not required. Preheating depends largely on the base metal composition. On large, complex, or restrained parts, a preheat of 150°- 260°C (300°- 500°F) may be necessary.

IMPORTANT: SPECIAL VENTILATION AND/OR EXHAUST REQUIRED

Fumes from the normal use of some welding products can contain significant quantities of components - such as chromium and manganese - which can lower the 5.0 mg/m³ maximum exposure guideline for general welding fume. BEFORE USE, READ AND UNDERSTAND THE SAFETY DATA SHEET (SDS) FOR THIS PRODUCT AND SPECIFIC INFORMATION PRINTED ON THE PRODUCT CONTAINER.

WEARSHIELD® MI

Metal-to-Metal Wear

KEY FEATURES

- Provides a martensitic deposit with considerable retained austenite
- General purpose electrode, a good compromise for metal-to-metal wear, moderate impact and mild abrasion
- Can be used on carbon and low alloy steel parts
- Deposits tend to cross check crack and are usually best limited to two layers

TYPICAL APPLICATIONS

- Boom heels
- Conveyor screws
- Dipper lips
- Tractor grousers
- Ditcher teeth
- Lumber equipment
- Hammer mills

WELDING POSITIONS

All, except vertical down

DIAMETERS / PACKAGING

Diameter in (mm)	Length in (mm)	10 lb (4.5 kg) Plastic Tube
1/8 (3.2)	14 (350)	ED022003
5/32 (4.0)	14 (350)	ED022005
3/16 (4.8)	14 (350)	ED022007

MECHANICAL PROPERTIES⁽¹⁾

Rockwell Hardness (R _c)		
1 Layer		2 or More Layers
50		54

DEPOSIT COMPOSITION⁽¹⁾

On Carbon Steel	%C	%Mn	%Si	%Cr	%Mo
2 or More Layers	0.9	0.4	0.4	9.5	0.6

TYPICAL OPERATING PROCEDURES

Polarity ⁽²⁾	Current (Amps)		
	1/8 in (3.2 mm)	5/32 in (4.0 mm)	3/16 in (4.8 mm)
DC+	70-120	110-150	150-200
AC	70-120	110-150	150-200

⁽¹⁾Composition and properties depend upon dilution. Single layer deposit properties depend upon base metal and/or build-up material. ⁽²⁾Preferred polarity is listed first.

NOTE: In welding with Wearshield® MI, a short arc or a long arc may be used. The short arc will give greater build-up with each bead. The long arc is ideal for depositing thin layers, though alloy recovery may be reduced. In depositing Wearshield® MI, preheat and interpass temperatures of 200°C (400°F) minimum are helpful, as well as limiting deposit to two layers, to reduce cracking and avoid chipping and fragmentation. Weld deposit cannot be cut with oxy-fuel process. Plasma arc and air-carbon arc processes can cut or gouge the weld deposit successfully. Grinding is usually best if the deposit needs to be shaped.

IMPORTANT: SPECIAL VENTILATION AND/OR EXHAUST REQUIRED

Fumes from the normal use of some welding products can contain significant quantities of components - such as chromium and manganese - which can lower the 5.0 mg/m³ maximum exposure guideline for general welding fume. BEFORE USE, READ AND UNDERSTAND THE SAFETY DATA SHEET (SDS) FOR THIS PRODUCT AND SPECIFIC INFORMATION PRINTED ON THE PRODUCT CONTAINER.

WEARSHIELD® MANGJET®

Build-up and Joining

KEY FEATURES

- For building up austenitic manganese steel and cladding carbon steels
- Produces an austenitic manganese deposit that will work harden in service
- Unlimited layers with proper preheat, interpass temperatures and procedures

TYPICAL APPLICATIONS

- Dragline pins
- Dipper teeth
- Crusher screens and rolls
- Chain hooks
- Hammers
- Bucket teeth

WELDING POSITIONS

All, except vertical down

DIAMETERS / PACKAGING

Diameter in (mm)	Length in (mm)	10 lb (4.5kg) Plastic Tube	10 lb (4.5kg) Easy Open Can
5/32 (4.0)	14 (350)	ED021976	
3/16 (4.8)	14 (350)	ED021978	
1/4 (6.4)	18 (450)		ED021979

MECHANICAL PROPERTIES⁽¹⁾

As-Welded (2 Layers)	Rockwell Hardness (R _c)	
	As-Welded (2 Layers)	Work Hardened (2 Layers)
18		47

DEPOSIT COMPOSITION⁽¹⁾

On Carbon Steel	%C	%Mn	%Si	%Mo	%S
2 or More Layers	0.65	14.5	0.14	1.15	0.01

TYPICAL OPERATING PROCEDURES

Polarity ⁽²⁾	Current (Amps)		
	5/32 in (4.0 mm)	3/16 in (4.8 mm)	1/4 in (6.4 mm)
DC+	120-180	160-260	200-350
AC	125-210	175-275	225-375

⁽¹⁾ Composition and properties depend upon dilution. Single layer deposit properties depend upon base metal and/or build-up material. ⁽²⁾ Preferred polarity is listed first.

NOTE: Work-hardened base metal or previously deposited weld metal should be ground off before applying a new deposit, since such areas are more prone to embrittlement and possible cracking. Areas that cannot be easily indented with a center punch should be removed.

When joining manganese steel, the joint should be prepared for 100% penetration. A cutting torch may be used to bevel the edges of the plate which can crack if care is not taken to prevent overheating the base metal.

Preheat is not necessary unless work is below room temperature, or if the part is unusually massive or complex in design. In such cases, heating the piece to about room temperature, or 38° - 66°C (100° - 150°F) at the most, should be sufficient.

As with all austenitic manganese welding products, interpass temperatures should be limited to 260°C (500°F) maximum. A stringer bead, or at most, a slight weave is recommended to limit heat build-up. Excessive heat build-up causes manganese carbide precipitation which damages the toughness of austenitic manganese.

IMPORTANT: SPECIAL VENTILATION AND/OR EXHAUST REQUIRED

Fumes from the normal use of some welding products can contain significant quantities of components - such as chromium and manganese - which can lower the 5.0 mg/m³ maximum exposure guideline for general welding fume. BEFORE USE, READ AND UNDERSTAND THE SAFETY DATA SHEET (SDS) FOR THIS PRODUCT AND SPECIFIC INFORMATION PRINTED ON THE PRODUCT CONTAINER.

WEARSHIELD® 15CRMN

Build-up and Joining

KEY FEATURES

- Provides a premium austenitic chromium manganese deposit
- Resists severe impact or gouging even in a single layer over carbon steel
- Used to join Hadfield manganese steel to itself or to carbon steel
- Excellent for build-up on carbon steel prior to chromium carbide hardfacing deposit with an electrode such as Wearshield® 60
- Unlimited layers

TYPICAL APPLICATIONS

- Crusher hammers
- Rebuilding and joining of austenitic manganese plates and parts
- Earth moving equipment

WELDING POSITIONS

All, except vertical down

DIAMETERS / PACKAGING

Diameter in (mm)	Length in (mm)	10 lb (4.5 kg) Plastic Tube
1/8 [3.2]	14 [350]	ED021980
5/32 [4.0]	14 [350]	ED021982
3/16 [4.8]	14 [350]	ED021984

MECHANICAL PROPERTIES⁽¹⁾

	Rockwell Hardness (R _c) (Single or Multiple Layers)	
	As-Welded	Work Hardened
	18-24	40-50

DEPOSIT COMPOSITION⁽¹⁾

On Carbon Steel	%C	%Mn	%Si	%Cr
2 or More Layers	0.35	14.0	0.6	15.0

TYPICAL OPERATING PROCEDURES

Polarity ⁽²⁾	Current (Amps)		
	1/8 in [3.2 mm]	5/32 in [4.0 mm]	3/16 in [4.8 mm]
DC+	140-160	190-210	220-250
AC	140-160	190-210	220-250

⁽¹⁾ Composition and properties depend upon dilution. Single layer deposit properties depend upon base metal and/or build-up material. ⁽²⁾ Preferred polarity is listed first.

NOTE: In welding with Wearshield® 15CrMn, a short arc is preferred. The electrode can easily be dragged without fear of snuffing out the arc. For situations involving severe impact and abrasion, a build-up of Wearshield® 15CrMn capped with a single layer of Wearshield® 60 or Lincore® 60-D can provide excellent service. In depositing Wearshield® 15CrMn on itself or on austenitic manganese steel, preheat is generally unnecessary unless the metal is below 16°C (60°F). However, highly hardenable carbon or low alloy steel base metals may require preheat in the 150°C - 204°C (300° - 400°F) range to avoid heat affected zone cracking.

Wearshield® 15CrMn deposits work harden rapidly, which makes them difficult to machine. Best results are obtained with carbide or ceramic tool bits. Avoid superficial cuts, and maintain a sharp cutting edge. Grinding can also be done successfully. Because of the high chromium content, Wearshield® 15CrMn cannot be cut with oxy-fuel processes. Plasma arc and air carbon arc processes can cut or gouge the weld deposit successfully. Limit interpass temperature to 260°C (500°F) to avoid embrittlement.

IMPORTANT: SPECIAL VENTILATION AND/OR EXHAUST REQUIRED

Fumes from the normal use of some welding products can contain significant quantities of components - such as chromium and manganese - which can lower the 5.0 mg/m³ maximum exposure guideline for general welding fume. BEFORE USE, READ AND UNDERSTAND THE SAFETY DATA SHEET (SDS) FOR THIS PRODUCT AND SPECIFIC INFORMATION PRINTED ON THE PRODUCT CONTAINER.

WEARSHIELD® FROG MANG®

Build-up and Joining

KEY FEATURES

- Designed specifically for building up manganese frogs and manganese crossing diamonds in the railroad industry
- Provides a high strength, high alloy austenitic manganese deposit to handle the increased loading of railroad cars
- Unlimited layers with proper preheat, interpass temperatures and procedures
- Resistant to deformation and the resultant metal flow

TYPICAL APPLICATIONS

- Manganese crossing diamonds
- Manganese railroad frogs

WELDING POSITIONS

All, except vertical down

DIAMETERS / PACKAGING

Diameter in (mm)	Length in (mm)	10 lb (4.5 kg) Easy Open Can
5/32 (4.0)	14 (350)	ED033134
3/16 (4.8)	14 (350)	ED033135
1/4 (6.4)	18 (450)	ED033133

MECHANICAL PROPERTIES⁽¹⁾

	Rockwell Hardness (R _c)	
	As-Welded	Work Hardened
	20 - 30	40 - 50

DEPOSIT COMPOSITION⁽¹⁾

On Carbon Steel	%C	%Mn	%Si	%Cr
6 Layers	1.20	21.0	0.4	5.3

TYPICAL OPERATING PROCEDURES

Polarity ⁽²⁾	Current (Amps)		
	5/32 in (4.0 mm)	3/16 in (4.8 mm)	1/4 in (6.4 mm)
DC+	140 - 175	175 - 215	235 - 280
AC	150 - 180	185 - 215	235 - 280

⁽¹⁾Composition and properties depend upon dilution. Single layer deposit properties depend upon base metal and/or build-up material. ⁽²⁾Preferred polarity is listed first.

NOTE: Weld Preparation Remove all damaged and foreign material by air-carbon arc gouging or grinding. Make sure all defective metal is removed. In the event hairline cracks remain at flangeway depth, use a 3.2 mm (1/8 in) E308 stainless electrode, such as Blue Max® or Red Baron® 308L AC-DC to tie up these cracks. This will avoid hot cracking during the build-up process. Apply only thin layers and do not build-up with E308 stainless. This is for emergency situations where no other alternative is available to repair flangeway cracks.

Use DC+ to avoid excessive spatter. When possible, weld at alternate locations (skip weld) to avoid overheating of metal in a localized area. Do not exceed interpass temperature of 260°C (500°F). Use a temperature marker 13 mm (1/2 in) from the welded area at frequent intervals to ensure that interpass temperature does not exceed 260°C (500°F).

Use a short arc and a stringer bead width of 10 to 13 mm (3/8 to 1/2 in).

Finish the casting by grinding to a safe contour. Leave enough weld metal during the welding process to allow a level and even contour after grinding. Make sure all areas are finished and the casting has no further visible defects. Check with straight edge so that the casting is free of low spots. As with all austenitic manganese welding products, interpass temperatures should be limited to 260°C (500°F) maximum. A stringer bead, or at most, a slight weave is recommended to limit heat build-up. Excessive heat build-up causes manganese carbide precipitation which damages the toughness of austenitic manganese.

IMPORTANT: SPECIAL VENTILATION AND/OR EXHAUST REQUIRED

Fumes from the normal use of some welding products can contain significant quantities of components - such as chromium and manganese - which can lower the 5.0 mg/m³ maximum exposure guideline for general welding fume. BEFORE USE, READ AND UNDERSTAND THE SAFETY DATA SHEET (SDS) FOR THIS PRODUCT AND SPECIFIC INFORMATION PRINTED ON THE PRODUCT CONTAINER.

WEARSHIELD[®] SUPER RAIL[™]

Metal to Metal Wear

KEY FEATURES

- Reduce carbon steel repairs by 50%
- Low material distortion upon impact
- Work hardens fast without cracking

TYPICAL APPLICATIONS

- Rail Ends/ Points
- Rail Crossing Points

WELDING POSITIONS

Flat and Horizontal

DIAMETERS / PACKAGING

Diameter in (mm)	Length in (mm)	10 lb (4.5 kg) Easy Open Can
3/16 (4.8)	14 (350)	ED035352

DEPOSIT COMPOSITION⁽¹⁾

On Carbon Steel	%C	%Mn	%Si	%Cr	%Mo	%Ni
4 Layers	<1	<5	<2	<5	<1	<3

TYPICAL OPERATING PROCEDURES

Polarity ⁽²⁾	Current (Amps) 3/16 in (4.8 mm)
DC+	175 - 215
AC	185 - 215

⁽¹⁾Composition and properties depend upon dilution. Single layer deposit properties depend upon base metal and/or build-up material. ⁽²⁾Preferred polarity is listed first.

IMPORTANT: SPECIAL VENTILATION AND/OR EXHAUST REQUIRED

Fumes from the normal use of some welding products can contain significant quantities of components - such as chromium and manganese - which can lower the 5.0 mg/m³ maximum exposure guideline for general welding fume. BEFORE USE, READ AND UNDERSTAND THE SAFETY DATA SHEET (SDS) FOR THIS PRODUCT AND SPECIFIC INFORMATION PRINTED ON THE PRODUCT CONTAINER.

WEARSHIELD® ABR

Metal to Earth for Moderate to Severe Impact & Moderate to Severe Abrasion

KEY FEATURES

- Provides good resistance to abrasion, impact and some metal-to-metal wear
- Good hot forging properties
- Use on carbon, stainless and manganese steels
- Deposits limited to two layers
- Can be forged readily without affecting its mechanical properties

TYPICAL APPLICATIONS

- Crusher hammers
- Coal mining cutters
- Dozer blades
- Truck chain and gears
- Dipper teeth and lips

WELDING POSITIONS

All

DIAMETERS / PACKAGING

Diameter in (mm)	Length in (mm)	10 lb (4.5 kg) Plastic Tube
1/8 (3.2)	14 (350)	ED021996
5/32 (4.0)	14 (350)	ED021998
3/16 (4.8)	14 (350)	ED022000

MECHANICAL PROPERTIES⁽¹⁾

Rockwell Hardness [R _c]	
1 Layer	2 Layers
24-53	28-53

DEPOSIT COMPOSITION⁽¹⁾

On Carbon Steel	%C	%Mn	%Si	%Cr	%Mo
2 Layers	2.1	1.1	0.75	6.5	0.40

TYPICAL OPERATING PROCEDURES

Polarity ⁽²⁾	Current (Amps)		
	1/8 in (3.2 mm)	5/32 in (4.0 mm)	3/16 in (4.8 mm)
DC+	40-150	75-200	110-250
AC	50-165	80-220	120-275

⁽¹⁾Composition and properties depend upon dilution. Single layer deposit properties depend upon base metal and/or build-up material. ⁽²⁾Preferred polarity is listed first.

NOTE: Wearshield® ABR can be forged readily without affecting its mechanical properties. As deposited, Wearshield® ABR weld metal is not machinable, although the deposit can be shaped by grinding. To obtain a deposit that is machinable with carbide tools, heat to about 749°C (1380°F) and hold for one hour per inch of thickness. Air cool to room temperature.

For maximum machinability, heat to 870° - 900°C (1600° - 1650°F) and hold for one hour per inch of thickness. Furnace cool to 650°C (1200°F) at a rate not exceeding 10°C (50°F) per hour, and air or furnace cool to room temperature. Variation in welding procedures will have little affect on abrasion resistance.

The abrasion resistance can be restored by heating to about 790°C (1450°F), quenching and tempering at 200°C (400°F).

IMPORTANT: SPECIAL VENTILATION AND/OR EXHAUST REQUIRED

Fumes from the normal use of some welding products can contain significant quantities of components - such as chromium and manganese - which can lower the 5.0 mg/m³ maximum exposure guideline for general welding fume. BEFORE USE, READ AND UNDERSTAND THE SAFETY DATA SHEET (SDS) FOR THIS PRODUCT AND SPECIFIC INFORMATION PRINTED ON THE PRODUCT CONTAINER.

WEARSHIELD® 44

Metal to Earth for Moderate to Severe Impact and Moderate to Severe Abrasion

KEY FEATURES

- Moderate hardness to resist abrasion with impact up to 600°C (1100°F)
- Higher alloy results and improved spalling resistance than Wearshield® ABR
- Can be used on carbon steels, low alloy steels, cast irons, austenitic manganese steels and austenitic stainless steels

TYPICAL APPLICATIONS

- Buckets
- Chain links
- Rolling mill guides
- Pulleys
- Ingot tongs

WELDING POSITIONS

Flat & Horizontal

DIAMETERS / PACKAGING

Diameter in (mm)	Length in (mm)	10 lb (4.5 kg) Plastic Tube
1/8 (3.2)	14 (350)	ED024940
5/32 (4.0)	14 (350)	ED024941

MECHANICAL PROPERTIES⁽¹⁾

	Rockwell Hardness (R _c)	
	1 Layer	4 Layers
	42	48

DEPOSIT COMPOSITION⁽¹⁾

On Carbon Steel	%C	%Mn	%Si	%Cr	%Mo
1 Layer	1.56	0.17	0.77	19.5	1.92
2 Layers	1.96	0.16	0.87	24.2	2.48
4 Layers	2.21	0.18	0.93	27.1	2.86

TYPICAL OPERATING PROCEDURES

Polarity ⁽²⁾	Current (Amps)	
	1/8 in (3.2 mm)	5/32 in (4.0 mm)
DC+	120 - 160	150 - 220
AC	130 - 160	180 - 220

⁽¹⁾Composition and properties depend upon dilution. Single layer deposit properties depend upon base metal and/or build-up material. ⁽²⁾Preferred polarity is listed first.

NOTE: Wearshield® 44 electrodes form a deep cup, which permits light dragging of the electrode during welding. The arc is steady with little spatter in the DC+ mode. During AC welding, the arc is also steady, but the usable current range is reduced, and the melt-off rates are reduced at any current. Since the amount of dilution does not affect the microstructure, the impact properties and abrasion resistance will be similar from the first layer to the last.

On cast irons, Wearshield® 44 deposits usually check crack. These check cracks should be closely spaced to prevent spalling. This is obtained by using stringer beads.

IMPORTANT: SPECIAL VENTILATION AND/OR EXHAUST REQUIRED

Fumes from the normal use of some welding products can contain significant quantities of components - such as chromium and manganese - which can lower the 5.0 mg/m³ maximum exposure guideline for general welding fume. BEFORE USE, READ AND UNDERSTAND THE SAFETY DATA SHEET (SDS) FOR THIS PRODUCT AND SPECIFIC INFORMATION PRINTED ON THE PRODUCT CONTAINER.

WEARSHIELD® ME

Metal to Earth for Moderate to Severe Impact & Moderate to Severe Abrasion

KEY FEATURES

- High alloy produces chrome carbides and austenite
- Provides greater abrasion resistance than Wearshield® ABR or Wearshield® 44
- Low dilution weld metal provides eutectic mix of chromium carbides and austenite, with limited primary carbides.
- To be used on carbon and low alloy, austenitic manganese and austenitic stainless steels

TYPICAL APPLICATIONS

- Muller tires
- Bucket teeth
- Augers
- Dozer blades

WELDING POSITIONS

Flat & Horizontal

DIAMETERS / PACKAGING

Diameter in (mm)	Length in (mm)	10 lb (4.5 kg) Plastic Tube
1/8 (3.2)	14 (350)	ED023323
5/32 (4.0)	14 (350)	ED023324
3/16 (4.8)	14 (350)	ED023325

MECHANICAL PROPERTIES⁽¹⁾

Rockwell Hardness (R _c)	
1 Layer	3 Layers
49	55

DEPOSIT COMPOSITION⁽¹⁾

On Carbon Steel	%C	%Mn	%Si	%Cr
1 Layer	2.5	0.17	0.8	27.0
2 Layers	3.0	0.17	1.0	30.5
3 Layers	3.3	0.16	1.1	32.6

TYPICAL OPERATING PROCEDURES

Polarity ⁽²⁾	Current (Amps)		
	1/8 in (3.2 mm)	5/32 in (4.0 mm)	3/16 in (4.8 mm)
DC+	125 - 175	175 - 250	220 - 330
AC	130 - 170	180 - 220	230 - 270

⁽¹⁾ Composition and properties depend upon dilution. Single layer deposit properties depend upon base metal and/or build-up material. ⁽²⁾ Preferred polarity is listed first.

NOTE: Wearshield® ME is a heavily coated electrode which forms a deep cup that permits light dragging of the stick during welding. Deposits generally check crack except for single layers on thin base metal. Stringer beads produce a consistent crack spacing of about 13-25 mm (1/2-1 in).

Wide weaves may produce very widely spaced check cracks which can lead to deposit spalling in multiple layers. Weaving is not recommended. For maximum spalling resistance on carbon and low alloy steels, especially in multiple layers, apply a butter layer of Wearshield® 15CrMn, Lincore® 15CrMn or an austenitic stainless steel electrode such as Excalibur (R) 309/309L AC-DC, before applying Wearshield® ME.

IMPORTANT: SPECIAL VENTILATION AND/OR EXHAUST REQUIRED

Fumes from the normal use of some welding products can contain significant quantities of components - such as chromium and manganese - which can lower the 5.0 mg/m³ maximum exposure guideline for general welding fume. BEFORE USE, READ AND UNDERSTAND THE SAFETY DATA SHEET (SDS) FOR THIS PRODUCT AND SPECIFIC INFORMATION PRINTED ON THE PRODUCT CONTAINER.

WEARSHIELD® 60

Metal to Earth (Earth Cutting & Digging) for Extreme Abrasion and Low to Moderate Impact

KEY FEATURES

- Designed to resist severe abrasion
- It exhibits higher alloy and higher abrasion resistance than Wearshield® ABR, Wearshield® 44 or Wearshield® ME
- Can be used on carbon, low alloy, stainless and manganese steels
- Deposits consist of primary carbides in a matrix of austenite-carbide eutectic
- Deposits should be limited to two layers

TYPICAL APPLICATIONS

- Conveyor screws
- Grader blades
- Crusher rolls, plates and jaws
- Sleeves
- Brick and coke machinery

WELDING POSITIONS

Flat & Horizontal

DIAMETERS / PACKAGING

Diameter in (mm)	Length in (mm)	10 lb (4.5 kg) Plastic Tube
1/8 (3.2)	14 (350)	ED022010
5/32 (4.0)	14 (350)	ED022011
3/16 (4.8)	14 (350)	ED022012

MECHANICAL PROPERTIES⁽¹⁾

Rockwell Hardness (R _c)	
1 Layer	2 Layers
57 - 60	60 - 62

DEPOSIT COMPOSITION⁽¹⁾

On Carbon Steel	%C	%Mn	%Si	%Cr	%Mo	%V
2 Layers	5.0	0.80	1.0	23.0	2.3	0.6

TYPICAL OPERATING PROCEDURES

Polarity ⁽²⁾	Current (Amps)		
	1/8 in (3.2 mm)	5/32 in (4.0 mm)	3/16 in (4.8 mm)
DC+	100 - 140	130 - 180	210 - 250
AC	110 - 150	140 - 200	230 - 270

⁽¹⁾Composition and properties depend upon dilution. Single layer deposit properties depend upon base metal and/or build-up material. ⁽²⁾Preferred polarity is listed first.

NOTE: The deposit is not machinable or forgeable. Cooling rate does not significantly influence abrasion resistance. Deposit will usually cross check.

If more than two-layer build-up is required, use Wearshield® 15CrMn (preferred), Wearshield® BU or Wearshield® BU30 for the preliminary layer or layers under Wearshield® 60. On manganese steel, use Wearshield® Mangjet® or Wearshield® 15CrMn as build-up. Preheat is not generally necessary except to be sure that work is in room temperature range 25° - 45°C (75° - 100°F). However, preheat of 120° - 200°C (250° - 400°F) may be necessary to prevent heat affected zone cracking on high carbon steel or low alloy steel base metals. If more than two layers must be used, or if cross checks must be eliminated, preheat to 650°C (1200°F).

Prolonged or repeated heating of manganese steel base metal over 260°C (500°F) can cause embrittlement and spalling. Avoid base metal embrittlement by:

- Limiting the temperature 260°C [500°F] at distances of 13 mm [1/2 in] away from the weld.
- Minimizing the time at elevated temperatures.

The correct welding technique is a vertical electrode with a 3.2 - 4.8 mm [1/8 - 3/16 in] arc length. The large ball on the end of the electrode should never touch the puddle. This technique will give a smooth transfer, low spatter and smooth bead.

IMPORTANT: SPECIAL VENTILATION AND/OR EXHAUST REQUIRED

Fumes from the normal use of some welding products can contain significant quantities of components - such as chromium and manganese - which can lower the 5.0 mg/m³ maximum exposure guideline for general welding fume. BEFORE USE, READ AND UNDERSTAND THE SAFETY DATA SHEET (SDS) FOR THIS PRODUCT AND SPECIFIC INFORMATION PRINTED ON THE PRODUCT CONTAINER.

LINCOLN® SHS® 9700E

Severe Abrasion

KEY FEATURES

- Lower cost while maintaining a near nanoscale (submicron) microstructure
- Provides exceptional wear resistance lasting significantly longer than most chrome carbide and complex carbide alloys
- Maintains high hardness after exposure to elevated temperatures
- Limited to 2 layers max

TYPICAL APPLICATIONS

- Wearplate
- Crusher rolls
- Ore Chutes
- Screw augers

DIAMETERS / PACKAGING

Diameter in (mm)	10 lb (4.5 kg) Carton
5/32 (4.0)	ED035669

MECHANICAL PROPERTIES⁽¹⁾

Rockwell Hardness [R _c]	Wear Resistance
67-70	ASTM G65-04 Procedure A 0.13 g mass loss

DEPOSIT COMPOSITION⁽¹⁾

%Fe	%C	%Cr	%B	%Nb	%Al	%Mn	%Si
Balance	<3	<18	<6	<10	<5	<2	<2

TYPICAL OPERATING PROCEDURES

Diameter, Polarity in (mm)	Current (Amps)
5/32 in (4.0), DC+	150-175

⁽¹⁾Limited to two layers

IMPORTANT: SPECIAL VENTILATION AND/OR EXHAUST REQUIRED

Fumes from the normal use of some welding products can contain significant quantities of components - such as chromium and manganese - which can lower the 5.0 mg/m³ maximum exposure guideline for general welding fume. BEFORE USE, READ AND UNDERSTAND THE SAFETY DATA SHEET (SDS) FOR THIS PRODUCT AND SPECIFIC INFORMATION PRINTED ON THE PRODUCT CONTAINER.

BLUE MAX[®] 2100

Maintenance and Repair

KEY FEATURES

- High resistance to cracking
- High strength
- Designed for joining difficult to weld steel

TYPICAL APPLICATIONS

- High carbon, low alloy, high strength, manganese steels
- Base for hardfacing or stainless steel cladding

WELDING POSITIONS

All, except vertical down

DIAMETERS / PACKAGING

Diameter mm [in]	Length in (mm)	10 lb (4.5 kg) Easy Open Can
2.5 [3/32]	14 [350]	ED032298
3.2 [1/8]	14 [350]	ED032299

MECHANICAL PROPERTIES⁽¹⁾

	Yield Strength ⁽²⁾ MPa (ksi)	Tensile Strength MPa (ksi)	Elongation %	Ferrite Number
Typical Results ⁽³⁾	670 (97)	805 (117)	22	> 50

TYPICAL OPERATING PROCEDURES

Polarity ⁽⁴⁾	Current (Amps)	
	2.4 mm [3/32 in]	3.2 mm [1/8 in]
DC+	40 - 80	75 - 110
AC	40 - 80	75 - 110

⁽¹⁾Composition and properties depend upon dilution. Single layer deposit properties depend upon base metal and/or build-up material.

⁽²⁾Measured with 0.2% offset ⁽³⁾See test results disclaimer ⁽⁴⁾Preferred polarity is listed first.

IMPORTANT: SPECIAL VENTILATION AND/OR EXHAUST REQUIRED

Fumes from the normal use of some welding products can contain significant quantities of components - such as chromium and manganese - which can lower the 5.0 mg/m³ maximum exposure guideline for general welding fume. BEFORE USE, READ AND UNDERSTAND THE SAFETY DATA SHEET (SDS) FOR THIS PRODUCT AND SPECIFIC INFORMATION PRINTED ON THE PRODUCT CONTAINER.

LINCORE[®] 57-G

Abrasion & Impact

KEY FEATURES

- Designed to meet the weldability and mechanical property needs of mining equipment suppliers and rebuilders
- Maintain resistance to check cracking with proper preheat and interpass temperature
- The hard martensitic matrix provides good metal-to-metal wear resistance and moderate impact resistance when tempered
- Can be used with the bulk tungsten carbide process for additional abrasion resistance and exceptional wear life

WELDING POSITIONS

All, except overhead

DIAMETERS / PACKAGING

Diameter in (mm)	10 lb (4.5 kg) Plastic Spool	25 lb (11.3 kg) Plastic Spool	500 lb (227 kg) Accu-Trak [®] Drum
1/16 (1.6)	ED037297	ED037298	ED037296
0.045 (1.1)	ED037794	ED037795	ED037796

TYPICAL APPLICATIONS

- Dragline Bucket Lips
- Augers
- Sugar Cane Harvesters
- Tire Shredders
- Tillage Tools

SHIELDING GAS

75-90% Ar / Balance CO₂
98% Ar / 2% O₂

MECHANICAL PROPERTIES⁽¹⁾

Shielding Gas	Rockwell Hardness (R _c)	Mass Loss (G65) (g)
75%Ar/25 CO ₂	56-59	0.36
98%Ar/2%O ₂	59-61	0.36

DEPOSIT COMPOSITION⁽¹⁾

On Carbon Steel (2 Layers)	%C	%Cr	%Nb	%Mn	%Mo	%Si	%V
1/16 in (1.6 mm) - Ar/CO ₂	0.9-1.1	7.6-10.0	1.3-1.8	1.2-1.6	0.5-0.6	0.8-1.2	1.4-1.9

TYPICAL OPERATING PROCEDURES

Diameter, Polarity ESO – in (mm)	Approx. Current (Amps)	Voltage (Volts)	Wire Feed Speed m/min (ipm)	Deposition Rate kg/hr (lb/hr)
1/16 in (1.6 mm), DC+, 5/8 (16) 75% Ar/25% CO ₂	240	28	3.8 (150)	2.6 (5.8)
	340	30	6.4 (250)	4.7 (10.4)
	420	32	8.9 (350)	6.8 (15.1)
1/16 in (1.6 mm), DC+, 3/4 (20) 90% Ar/10% CO ₂	230	26	3.8 (150)	2.7 (6.0)
	315	27	6.4 (250)	4.9 (10.7)
	400	29	8.9 (350)	7.0 (15.4)
1/16 in (1.6 mm), DC+, 3/4 (20) 98% Ar/2% O ₂	220	23	3.8 (150)	2.9 (6.4)
	320	26	6.4 (250)	5.0 (11.0)
	415	28	8.9 (350)	7.1 (15.7)

⁽¹⁾ Based on two layers. Composition and properties depend upon dilution.

NOTE: Work area should be clean, with any previous hardfacing deposit removed, and cracks properly repaired. Cold parts should be warmed to at least 250°C (750°F). Higher preheat of 150°- 260°C (300°- 500°F) on thick parts or heavy sections.

IMPORTANT: SPECIAL VENTILATION AND/OR EXHAUST REQUIRED

Fumes from the normal use of some welding products can contain significant quantities of components - such as chromium and manganese - which can lower the 5.0 mg/m³ maximum exposure guideline for general welding fume. BEFORE USE, READ AND UNDERSTAND THE SAFETY DATA SHEET (SDS) FOR THIS PRODUCT AND SPECIFIC INFORMATION PRINTED ON THE PRODUCT CONTAINER.

LINCORE® 60-G

Severe Abrasion

KEY FEATURES

- Iron base chromium carbide alloy designed for applications subject to severe metal to earth abrasion with moderate impact
- Can be used at temperatures up to 704°C (1300°F)
- Can be used on carbon, low alloy, manganese and stainless steels and cast irons
- Deposit is limited to two layers

WELDING POSITIONS

Flat & Horizontal

TYPICAL APPLICATIONS

- Augers
- Bucket lips and sides
- Loaders
- Grinding equipment
- Shaper sides and blades
- Farming Tools
- Mining equipment

SHIELDING GAS

75-90% Argon / Balance CO₂
98% Argon / 2% O₂

DIAMETERS / PACKAGING

Diameter in (mm)	10 lb (4.5 kg) Plastic Spool	25 lb (11.3 kg) Plastic Spool	33 lb (15 kg) Spool	300 lb (136 kg) Accu-Trak® Drum
1/16 (1.6)	ED037373	ED036545	ED037372	ED031861
0.045 (1.1)	ED036455	ED029936		

MECHANICAL PROPERTIES⁽¹⁾

Rockwell Hardness (R _c)	
1 Layer	2 Layer
58	60

DEPOSIT COMPOSITION⁽¹⁾

On Carbon Steel	%C	%Mn	%Si	%Cr
1 Layer	4.6	1.2	0.5	13.8
2 Layers	5.5	1.3	0.6	17.3

TYPICAL OPERATING PROCEDURES

Diameter, Polarity, ESO - in (mm) Shielding Gas	Wire Feed Speed m/min (in/min)	Voltage (Volts)
0.045 in (1.1 mm), DC+, 3/4 (20) 75% Ar/25% CO ₂	5.1 (200)	23 - 24
	7.6 (300)	25 - 26
	10.2 (400)	27 - 28
0.045 in (1.1 mm), DC+, 3/4 (20) 90% Ar/10% CO ₂	5.1 (200)	22 - 23
	7.6 (300)	24 - 25
	10.2 (400)	26 - 27
0.045 in (1.1 mm), DC+, 3/4 (20) 98% Ar/2% O ₂	5.1 (200)	22 - 23
	7.6 (300)	24 - 25
	10.2 (400)	26 - 27

⁽¹⁾ Composition and properties depend upon dilution. Single layer deposit properties depend upon base metal and/or build-up material. ⁽²⁾ See test results disclaimer

IMPORTANT: SPECIAL VENTILATION AND/OR EXHAUST REQUIRED

Fumes from the normal use of some welding products can contain significant quantities of components - such as chromium and manganese - which can lower the 5.0 mg/m³ maximum exposure guideline for general welding fume. BEFORE USE, READ AND UNDERSTAND THE SAFETY DATA SHEET (SDS) FOR THIS PRODUCT AND SPECIFIC INFORMATION PRINTED ON THE PRODUCT CONTAINER.

LINCORE[®] 70-G

Severe Abrasion

KEY FEATURES

- Exceptional wear resistance with deposits that last approximately 2-3 times longer than most chrome carbide and complex carbide alloys, especially in wet abrasion applications
- Maintains high hardness after exposure to elevated temperatures up to 1000°F (538°C)
- Running this wire as a GMAW-C wire with the recommended shielding gas will reduce fume compared to open arc (FCAW-S) applications
- Best suited for carbon and low alloy steels. Not compatible for austenitic stainless or austenitic manganese steels. Limited to a maximum of two layers
- Great for high value applications where downtime is costly or replacement parts are expensive

WELDING POSITIONS

Flat & Horizontal Only

TYPICAL APPLICATIONS

- Wearplate
- Crusher Rolls
- Ore Chutes
- Screw Augers

SHIELDING GAS

75% Ar / 25% CO₂
Argon Blends

DIAMETERS / PACKAGING

Diameter in (mm)	10 lb (4.5 kg) Spool	33 lb (15 kg) Spool	55 lb (25 kg) Coil
0.045 (1.1)	ED037243	ED037244	-
1/16 (1.6)	ED037245	ED037246	-
5/64 (2.0)	-	ED037247	-
7/64 (2.8)	-	-	ED037248

MECHANICAL PROPERTIES⁽¹⁾

Rockwell Hardness [R _c]	Wear Resistance (ASTM G65-04 Procedure A)
67-70	0.13 g mass loss

DEPOSIT COMPOSITION⁽¹⁾

%Fe	%C	%Cr%	%B	%Nb	%Al	%Mn	%Si
Balance	<3	<18	<6	<10	<5	<2	<2

⁽¹⁾ Composition and properties depend on dilution. Single layer deposit properties depend upon base metal and/or build-up material.

IMPORTANT: SPECIAL VENTILATION AND/OR EXHAUST REQUIRED

Fumes from the normal use of some welding products can contain significant quantities of components - such as chromium and manganese - which can lower the 5.0 mg/m³ maximum exposure guideline for general welding fume. BEFORE USE, READ AND UNDERSTAND THE SAFETY DATA SHEET (SDS) FOR THIS PRODUCT AND SPECIFIC INFORMATION PRINTED ON THE PRODUCT CONTAINER.

LINCORE[®] M7-G

Metal to Metal

KEY FEATURES

- Produces a tool steel deposit similar to AISI M7
- Good combination of hardness, abrasion resistance, and impact resistance
- 1-6 layers with proper preheat and interpass temperatures
- Cladding
- Edge retention
- Max carbide volume evenly distributed for extended wear life

TYPICAL APPLICATIONS

- Tire Shredders
- Cutting and Shaving Knives
- Shear Braces
- Cladding High Wear Areas on Equipment
- Building up Composite Dies and Tools

WELDING POSITIONS

Flat and Horizontal

SHIELDING GAS

75/25 Ar/CO₂

DIAMETERS / PACKAGING

Diameter in (mm)	25 lb (11.3 kg) plastic spool	50 lb (22.7kg) Coil	50 lb (22.7kg) fiber spool	500 lb (227 kg) Accu-Trak [®] Drum
0.045 (1.2)	ED037476	ED037477	ED037679	—
1/16 (1.6)	ED037470	—	ED037565	ED037910

DEPOSIT COMPOSITION

	%C	%Cr	%Mn	%Mo	%Si	%V	%W
2 layers	0.8	2.9	0.4	6.1	0.6	1.4	1.2
4 layers	0.9	3.8	0.4	8.1	0.8	1.9	1.5

MECHANICAL PROPERTIES

Rockwell Hardness (R_c)

60-65

TYPICAL OPERATING PROCEDURES

Diameter in (mm)	Approx. Current (amps)	Wire Feed Speed (in/min)	Deposition rate (lb/hr)	Voltage (volts)	CTWD in (mm)
1/16 (1.6)	235	140	6.2	21	5/8
	305	220	9.4	25	5/8
	375	360	15.1	30	1

⁰⁰See test results disclaimer.

IMPORTANT: SPECIAL VENTILATION AND/OR EXHAUST REQUIRED

Fumes from the normal use of some welding products can contain significant quantities of components - such as chromium and manganese - which can lower the 5.0 mg/m³ maximum exposure guideline for general welding fume. BEFORE USE, READ AND UNDERSTAND THE SAFETY DATA SHEET (SDS) FOR THIS PRODUCT AND SPECIFIC INFORMATION PRINTED ON THE PRODUCT CONTAINER.

LINCORE® 55-G

Metal-to-Metal

KEY FEATURES

- Produces a deposit which resists metal-to-metal wear and mild abrasion
- The deposit results in an even harder material when used with the Bulk Tungsten Carbide process
- To be used on carbon steel and low alloy steel
- Unlimited layers with proper preheat and interpass temperatures and procedures

TYPICAL APPLICATIONS

- Crane wheels
- Blower blades
- Bucket lips
- Dredge parts
- Tillage tools

SHIELDING GAS

75-90% Argon / Balance CO₂
98% Argon / 2% O₂

WELDING POSITIONS

All, except overhead

DIAMETERS / PACKAGING

Diameter in (mm)	10 lb (4.5 kg) Plastic Spool	25 lb (11.3 kg) Steel Spool	500 lb (227 kg) Accu-Trak® Drum	25 lb (11.3 kg) Plastic Spool	200 lb (90 kg) Accu-Trak® Drum	250 lb (113 kg) Accu-Trak® Drum	500 lb (227 kg) Accu-Trak® Drum
0.045 (1.1)	ED036444			ED028176			ED031475
0.052 (1.3)		ED037409	ED037410				
1/16 (1.6)				ED028177	ED037525	ED036653	ED032661

MECHANICAL PROPERTIES⁽¹⁾

Shielding Gas	Rockwell Hardness (R _c)		
	1 Layer	2 Layer	4 Layers
75%Ar/25%CO ₂	50 - 51	53 - 54	54 - 55
98%Ar/2%O ₂	54 - 55	55 - 56	56 - 57

DEPOSIT COMPOSITION⁽¹⁾

On Carbon Steel (2 Layers)	%C	%Mn	%Si	%Cr	%Mo
0.045 in (1.1 mm) - Ar/CO ₂	0.39	1.24	0.75	5.61	0.55
0.045 in (1.1 mm) - Ar/O ₂	0.47	1.45	0.95	6.44	0.65
1/16 in (1.6 mm) - Ar/CO ₂	0.41	1.24	0.75	5.3	0.57
1/16 in (1.6 mm) - Ar/O ₂	0.45	1.25	0.95	5.5	0.58

TYPICAL OPERATING PROCEDURES

Diameter, Polarity, ESO - in (mm) Shielding Gas	Wire Feed Speed m/min (in/min)	Voltage (Volts)	Approx. Current (Amps)	Deposition Rate kg/hr (lb/hr)
0.045 in (1.1 mm) , DC+, 5/8 (16) 75% Ar/25% CO ₂	5.1 (200)	27	165	2.0 (4.3)
	7.6 (300)	29	225	3.0 (6.7)
	10.2 (400)	31	290	4.2 (9.2)
0.045 in (1.1 mm) , DC+, 3/4 (20) 90% Ar/10% CO ₂	5.1 (200)	25	145	2.1 (4.7)
	7.6 (300)	28	195	3.3 (7.2)
	10.2 (400)	30	245	4.4 (9.7)
0.045 in (1.1 mm) , DC+, 3/4 (20) 98% Ar/2% O ₂	5.1 (200)	25	145	2.3 (5.1)
	7.6 (300)	27	200	3.4 (7.5)
	8.9 (350)	28	225	3.9 (8.7)
	10.2 (400)	29	250	4.4 (9.8)
1/16 in (1.6 mm) , DC+, 5/8 (16) 75% Ar/25% CO ₂	3.8 (150)	28	260	2.6 (5.8)
	6.4 (250)	30	340	4.7 (10.4)
	8.9 (350)	32	420	6.8 (15.1)
1/16 in (1.6 mm) , DC+, 3/4 (20) 90% Ar/10% CO ₂	3.8 (150)	25	230	2.7 (6.0)
	6.4 (250)	27	315	4.9 (10.7)
	8.9 (350)	29	400	7.0 (15.4)
1/16 in (1.6 mm) , DC+, 3/4 (20) 98% Ar/2% O ₂	3.8 (150)	24	220	2.9 (6.4)
	6.4 (250)	26	315	5.0 (11.0)
	8.9 (350)	28	410	7.1 (15.7)

⁽¹⁾ Composition and properties depend upon dilution. Single layer deposit properties depend upon base metal and/or build-up material.

NOTE: Work area should be clean, with any previous hardfacing deposit removed, and cracks properly repaired. Cold parts should be warmed to at least 250°C (750°F). Higher preheat of 150° - 260°C (300° - 500°F) on thick parts or heavy sections.

IMPORTANT: SPECIAL VENTILATION AND/OR EXHAUST REQUIRED
Fumes from the normal use of some welding products can contain significant quantities of components - such as chromium and manganese - which can lower the 5.0 mg/m ³ maximum exposure guideline for general welding fume. BEFORE USE, READ AND UNDERSTAND THE SAFETY DATA SHEET (SDS) FOR THIS PRODUCT AND SPECIFIC INFORMATION PRINTED ON THE PRODUCT CONTAINER.

LINCORE® 30-S

Build-Up

KEY FEATURES

- Intended for build-up before final overlay, and as a final surface for metal-to-metal wear with moderate impact
- For automatic and semiautomatic operation on mild and low alloy steels
- Good resistance to cross checking
- Unlimited deposit thickness with proper preheat and interpass temperatures and procedures

TYPICAL APPLICATIONS

- | | |
|-------------------|-----------------|
| For Build-up: | For Hardfacing: |
| • Tractor rollers | • Shafts |
| • Trunnions | • Track rails |
| • Idlers | • Idlers |
| • Crane wheels | |

WELDING POSITIONS

Flat, Horizontal and Circumferential

RECOMMENDED FLUX

Primary Flux	Secondary Flux ⁽¹⁾
801	802, 860

⁽¹⁾ 802 and 860 standard flux are not sized for semiautomatic applications; however, they can be ordered in special sizing by contacting your Lincoln Electric representative.

DIAMETERS / PACKAGING

Diameter in (mm)	50 lb (22.7 kg) Coil	600 lb (272 kg) Speed-Feed [®] Drum
3/32 (2.4)	ED011200	ED011199
1/8 (3.2)	ED015889	ED015891

MECHANICAL PROPERTIES⁽¹⁾

Rockwell Hardness (R _c)	
6 Layers - Under 801 or 802 Flux	6 Layers - Under 860 Flux
27	27

DEPOSIT COMPOSITION⁽¹⁾

	%C	%Mn	%Si	%Mo
6 Layers - Under 801 or 802	0.11	2.5	0.40	0.50
6 Layers - Under 860	0.11	2.7	0.60	0.50

TYPICAL OPERATING PROCEDURES

Diameter, Polarity ESO - in (mm)	Wire Feed Speed m/min (in/min)	Voltage (Volts)	Approx. Current (Amps)	Deposition Rate kg/hr (lb/hr)
3/32 in (2.4 mm), DC+ 1 1/2 (38)	1.5 (60)	26	220	2.7 (6.0)
	3.0 (120)	27	360	5.2 (11.5)
	4.6 (180)	28	500	7.7 (17.0)
1/8 in (3.2 mm), DC+ 1 5/8 (40)	1.3 (50)	27	310	3.4 (7.5)
	2.0 (80)	28	450	6.4 (14.0)
	2.8 (110)	28	600	9.1 (20.0)

⁽¹⁾ Composition and properties depend upon dilution. Single layer deposit properties depend upon base metal and/or build-up material.

IMPORTANT: SPECIAL VENTILATION AND/OR EXHAUST REQUIRED

Fumes from the normal use of some welding products can contain significant quantities of components - such as chromium and manganese - which can lower the 5.0 mg/m³ maximum exposure guideline for general welding fume. BEFORE USE, READ AND UNDERSTAND THE SAFETY DATA SHEET (SDS) FOR THIS PRODUCT AND SPECIFIC INFORMATION PRINTED ON THE PRODUCT CONTAINER.

LINCORE® 32-S

Metal-to-Metal, Build-Up

KEY FEATURES

- Designed for build-up on 4140 drill stems in the deep hole drilling industry
- For automatic and semiautomatic operation on mild and low alloy steels
- Good resistance to cross checking
- Unlimited deposit thickness with proper preheat and interpass temperatures and procedures

TYPICAL APPLICATIONS

- Drill stems

RECOMMENDED FLUX

Primary Flux ⁽¹⁾	Secondary Flux
802	860

⁽¹⁾ 802 and 860 standard flux are not sized for semiautomatic applications; however, they can be ordered in special sizing by contacting your Lincoln Electric representative.

DIAMETERS / PACKAGING

Diameter in (mm)	300 lb (136 kg) Speed-Feed® Drum	600 lb (272 kg) Speed-Feed® Drum
3/32 (2.4)	ED025656	
1/8 (3.2)		ED025131

MECHANICAL PROPERTIES⁽¹⁾

Rockwell Hardness (R _c)	
2 Layers Under 802 Flux	2 Layers on 4140 Steel Under 802 Flux
28	33

DEPOSIT COMPOSITION⁽¹⁾

	%C	%Mn	%Si	%Cr	%Mo	%Ni
2 Layers w/ 802	0.05	2.20	0.60	1.80	0.33	0.07
On 4140 Steel						
2 Layers w/ 802	0.13	2.11	0.51	1.63	0.30	0.09

TYPICAL OPERATING PROCEDURES

Diameter, Polarity ES0 - in (mm)	Wire Feed Speed m/min (in/min)	Voltage (Volts)	Approx. Current (Amps)	Deposition Rate kg/hr (lb/hr)
3/32 in (2.4 mm) , DC+ 1 1/2 (38)	1.9 (75)	25	350	3.4 (7.5)
	2.5 (100)	25	400	4.5 (10.0)
	3.3 (130)	25	460	5.9 (13.0)
	4.2 (165)	25	510	7.5 (16.5)
1/8 in (3.2 mm) , DC+ 1 5/8 (40)	1.3 (50)	28	370	3.9 (8.5)
	2.5 (100)	28	540	7.9 (17.5)
	3.2 (125)	28	630	9.6 (21.1)
	3.8 (150)	28	720	11.8 (26.0)

⁽¹⁾ Composition and properties depend upon dilution. Single layer deposit properties depend upon base metal and/or build-up material.

IMPORTANT: SPECIAL VENTILATION AND/OR EXHAUST REQUIRED

Fumes from the normal use of some welding products can contain significant quantities of components - such as chromium and manganese - which can lower the 5.0 mg/m³ maximum exposure guideline for general welding fume. BEFORE USE, READ AND UNDERSTAND THE SAFETY DATA SHEET (SDS) FOR THIS PRODUCT AND SPECIFIC INFORMATION PRINTED ON THE PRODUCT CONTAINER.

LINCORE® 35-S

Metal-to-Metal, Build-Up

KEY FEATURES

- Intended for rolling and sliding metal-to-metal wear with moderate impact and abrasion
- For automatic and semiautomatic operation on mild and low alloy steels
- Recommended as final overlay where medium hardness and good machinability are required
- Unlimited deposit thickness with proper preheat and interpass temperatures and procedures

TYPICAL APPLICATIONS

- | | |
|-------------------|--------------------|
| For Build-up | For Hardfacing |
| • Tractor rollers | • Mine car wheels |
| • Idlers | • Track rails |
| • Trunnions | • Shafts |
| • Crane wheels | • Bearing journals |
| • Caster rolls | |

RECOMMENDED FLUXES

Primary Flux	Secondary Flux ⁽¹⁾
801	802, 880

⁽¹⁾ 802 and 860 standard flux are not sized for semiautomatic applications; however, they can be ordered in special sizing by contacting your Lincoln Electric representative.

DIAMETERS / PACKAGING

Diameter in (mm)	50 lb (22.7 kg) Coil	600 lb (272 kg) Speed-Feed [®] Drum
3/32 (2.4)	ED019880	ED019883
1/8 (3.2)	ED019881	ED019884
5/32 (4.0)		ED019885

MECHANICAL PROPERTIES⁽¹⁾

Rockwell Hardness (R _c)
39

DEPOSIT COMPOSITION⁽¹⁾

	%C	%Mn	%Si	%Cr	%Mo
With Recommended Neutral Flux	0.19	1.7	0.60	2.3	0.50

TYPICAL OPERATING PROCEDURES

Diameter, Polarity ESO - in (mm)	Wire Feed Speed m/min (in/min)	Voltage (Volts)	Approx. Current (Amps)	Deposition Rate kg/hr (lb/hr)
1/8 in (3.2 mm), DC+	1 5/8 (40)	28	340	3.6 (8.0)
	1 1/2 (38)	28	500	7.5 (16.5)
	1 1/4 (35)	28	660	11.3 (25.0)

⁽¹⁾ Composition and properties depend upon dilution. Single layer deposit properties depend upon base metal and/or build-up material.

IMPORTANT: SPECIAL VENTILATION AND/OR EXHAUST REQUIRED

Fumes from the normal use of some welding products can contain significant quantities of components - such as chromium and manganese - which can lower the 5.0 mg/m³ maximum exposure guideline for general welding fume. BEFORE USE, READ AND UNDERSTAND THE SAFETY DATA SHEET (SDS) FOR THIS PRODUCT AND SPECIFIC INFORMATION PRINTED ON THE PRODUCT CONTAINER.

LINCORE® 40-S

Metal-to-Metal

KEY FEATURES

- Designed for rebuilding heavy equipment undercarriages
- Deposit is machinable and hot forgeable and resists rolling and sliding metal-to-metal wear
- Use on carbon and low alloy steels for good puddle control on round-about welding
- Limited to 4 layers

TYPICAL APPLICATIONS

- Idlers
- Drive sprockets
- Mine car wheels

RECOMMENDED FLUXES

Primary Flux	Secondary Flux ⁽¹⁾
801	802, 880

⁽¹⁾ 802 and 880 standard flux are not sized for semiautomatic applications; however, they can be ordered in special sizing by contacting your Lincoln Electric representative.

DIAMETERS / PACKAGING

Diameter in (mm)	50 lb (22.7 kg) Coil	600 lb (272 kg) Speed-Feed [®] Drum
1/8 (3.2)	ED015892	ED015909

MECHANICAL PROPERTIES⁽¹⁾

Rockwell Hardness (R _c) 3 or More Layers After 2 Hours Post Weld Heat Treat
39 - 42

DEPOSIT COMPOSITION⁽¹⁾

	%C	%Mn	%Si	%Cr	%Mo
With Recommended Neutral Flux	0.12	2.75	0.50	3.30	0.85

TYPICAL OPERATING PROCEDURES

Diameter, Polarity ESO - in (mm)	Wire Feed Speed m/min (in/min)	Voltage (Volts)	Approx. Current (Amps)	Deposition Rate kg/hr (lb/hr)
1/8 in (3.2 mm), DC+ 1 1/4 (32)	1.7 (65)	27	330	4.4 (9.6)
	2.3 (90)	28	425	5.9 (12.9)
	3.0 (120)	29	525	7.8 (17.3)
1/8 in (3.2 mm), DC+ 2 1/2 (65)	2.0 (80)	29	345	5.2 (11.5)
	2.8 (110)	30	425	7.3 (16.0)
	3.7 (145)	31	500	9.4 (20.8)
1/8 in (3.2 mm), DC+ 3 1/2 (90)	2.5 (100)	31	375	6.5 (14.3)
	3.3 (130)	32	435	8.6 (18.9)
	4.6 (180)	33	520	11.9 (26.1)

⁽¹⁾ Composition and properties depend upon dilution. Single layer deposit properties depend upon base metal and/or build-up material.

<p>IMPORTANT: SPECIAL VENTILATION AND/OR EXHAUST REQUIRED</p> <p>Fumes from the normal use of some welding products can contain significant quantities of components - such as chromium and manganese - which can lower the 5.0 mg/m³ maximum exposure guideline for general welding fume.</p> <p>BEFORE USE, READ AND UNDERSTAND THE SAFETY DATA SHEET (SDS) FOR THIS PRODUCT AND SPECIFIC INFORMATION PRINTED ON THE PRODUCT CONTAINER.</p>
--

LINCORE[®] 42-S

Metal-to-Metal

KEY FEATURES

- Designed for rebuilding heavy equipment undercarriages
- The deposit exhibits enhanced crack resistance and toughness compared to Lincore[®] 40-S
- Intended to resist rolling and sliding metal-to-metal wear
- For automatic and semiautomatic operation

TYPICAL APPLICATIONS

- Tractor rollers
- Tractor idlers
- Track pads

RECOMMENDED FLUXES

Primary Flux	Secondary Flux
801	802, 880

⁽¹⁾ 802 and 880 standard flux are not sized for semiautomatic applications; however, they can be ordered in special sizing by contacting your Lincoln Electric representative.

DIAMETERS / PACKAGING

Diameter in (mm)	300 lb (136 kg) Speed-Feed [®] Drum	600 lb (272 kg) Speed-Feed [®] Drum
1/8 (3.2)	ED029264	ED029161

MECHANICAL PROPERTIES⁽¹⁾

Rockwell Hardness (R _c) 1 Layer
40

DEPOSIT COMPOSITION⁽¹⁾

With Recommended Neutral Flux	%C	%Mn	%Si	%Cr	%Mo
1/8 in Diameter (3/4 in ESO)					
1 Layer	0.14	2.13	0.34	1.45	0.43
2 Layers	0.12	2.70	0.39	2.22	0.66
4 Layers	0.11	3.33	0.44	2.95	0.84
6 Layers	0.10	3.51	0.46	3.20	0.80
1/8 in Diameter (1-5/8 in ESO)					
1 Layer	0.14	2.49	0.33	2.02	0.60
2 Layers	0.13	3.05	0.42	2.96	0.84
4 Layers	0.13	3.41	0.47	3.15	0.99
6 Layers	0.13	3.55	0.51	3.31	1.06

TYPICAL OPERATING PROCEDURES

Diameter, Polarity ESO - in (mm)	Wire Feed Speed m/min (in/min)	Voltage (Volts)	Approx. Current (Amps)	Deposition Rate kg/hr (lb/hr)
1/8 in (3.2 mm), DC+ 3/4 (20)	1.3 (50)	27	350	3.8 (8.4)
	2.5 (100)	28	565	7.5 (16.5)
	3.2 (125)	29	675	9.3 (20.5)
1/8 in (3.2 mm), DC+ 1 5/8 (40)	1.3 (50)	27	325	3.8 (8.3)
	2.5 (100)	28	510	7.5 (16.6)
	3.2 (125)	29	605	9.4 (20.8)

⁽¹⁾ Composition and properties depend upon dilution. Single layer deposit properties depend upon base metal and/or build-up material.

IMPORTANT: SPECIAL VENTILATION AND/OR EXHAUST REQUIRED

Fumes from the normal use of some welding products can contain significant quantities of components - such as chromium and manganese - which can lower the 5.0 mg/m³ maximum exposure guideline for general welding fume. BEFORE USE, READ AND UNDERSTAND THE SAFETY DATA SHEET (SDS) FOR THIS PRODUCT AND SPECIFIC INFORMATION PRINTED ON THE PRODUCT CONTAINER.

LINCORE[®] 20

Roll Rebuilding, Build Up

KEY FEATURES

- Metal-cored wire with moderate hardness for build-up before stainless overlay
- Good crack resistance and high compressive strength

TYPICAL APPLICATIONS

- Caster rolls

RECOMMENDED FLUX

Primary Flux	Secondary Flux ⁽¹⁾
801	802, 880

⁽¹⁾ 802 and 860 standard flux are not sized for semiautomatic applications; however, they can be ordered in special sizing by contacting your Lincoln Electric representative.

DIAMETERS / PACKAGING

Diameter in (mm)	600 lb (272 kg) Speed-Feed [®] Drum
3/32 (2.4)	-
1/8 (3.2)	ED018569
5/32 (4.0)	EDS18570

MECHANICAL PROPERTIES⁽¹⁾

Rockwell Hardness [R _c]
23 - 28

DEPOSIT COMPOSITION⁽¹⁾

With Recommended Neutral Flux					
%C	%Mn	%Si	%Cr	%Ni	%Mo
0.05	0.60	0.40	1.40	2.40	0.40

TYPICAL OPERATING PROCEDURES

Diameter, Polarity ESD - in (mm)	Wire Feed Speed m/min (in/min)	Voltage (Volts)	Approx. Current (Amps)	Deposition Rate kg/hr (lb/hr)
3/32 in (2.4 mm), DC+ 3/4 (20)	1.7 (65)	24	270	3.0 (6.7)
	3.0 (120)	28	400	5.6 (12.4)
	4.4 (175)	31	500	8.2 (18.1)
1/8 in (3.2 mm), DC+ 3/4 (20)	1.5 (60)	26	400	4.7 (10.4)
	2.5 (100)	28	550	7.8 (17.3)
	3.6 (140)	30	680	11.0 (24.2)
5/32 in (4.0 mm), DC+ 1 1/2 (38)	1.4 (55)	27	520	6.6 (14.6)
	2.2 (85)	30	725	10.2 (22.5)
	2.9 (115)	32	880	13.8 (30.4)

⁽¹⁾ Composition and properties depend upon dilution. Single layer deposit properties depend upon base metal and/or build-up material.

IMPORTANT: SPECIAL VENTILATION AND/OR EXHAUST REQUIRED

Fumes from the normal use of some welding products can contain significant quantities of components - such as chromium and manganese - which can lower the 5.0 mg/m³ maximum exposure guideline for general welding fume. BEFORE USE, READ AND UNDERSTAND THE SAFETY DATA SHEET (SDS) FOR THIS PRODUCT AND SPECIFIC INFORMATION PRINTED ON THE PRODUCT CONTAINER.

LINCORE® 420HC-S

Roll Rebuilding, Metal-to-Metal

KEY FEATURES

- Metal-cored wire which produces a high carbon, 420 stainless steel deposit
- Use where a higher hardness is required
- Used on rolls and backup rolls when water spray causes pitting on tool steel deposits

TYPICAL APPLICATIONS

- Caster rolls

RECOMMENDED FLUX

Lincolnweld® 801®, Lincolnweld® 802™

WELDING POSITIONS

Flat, Horizontal and Circumferential

DIAMETERS / PACKAGING

Diameter in. (mm)	50 lb (22.7 kg) Coil	600 lb (272 kg) Speed-Feed® Drum
3/32 (2.4)	ED037315	ED037314
1/8 (3.2)	ED037313	ED037312

MECHANICAL PROPERTIES⁽¹⁾

Rockwell Hardness [R_c]

51-55

DEPOSIT COMPOSITION⁽¹⁾ – with Recommended Neutral Flux

%C	%Mn	%Si	%S	%P	%Cr
0.26	1.1	0.3	0.005	0.010	12.0

TYPICAL OPERATING PROCEDURES

Diameter, Polarity ESO - in (mm)	Wire Feed Speed m/min (in/min)	Voltage (Volts)	Approx. Current (Amps)	Deposition Rate kg/hr (lb/hr)
3/32 in. (2.4 mm), DC+ 1-1/2 (38)	1.7 (65)	24	250	2.6 (5.7)
	2.5 (100)	28	525	71 (15.7)
	4.4 (175)	31	450	70 (15.5)
1/8 in. (3.2 mm), DC+ 1-5/8 (40)	1.5 (60)	26	360	4.3 (9.4)
	2.5 (100)	28	525	71 (15.7)
	3.6 (140)	30	635	10.0 (10.0)

⁽¹⁾ Composition and properties depend upon dilution. Single layer deposit properties depend upon base metal and/or build-up material.

LINCORE® 4130

Roll Rebuilding, Build Up

KEY FEATURES

- Metal-cored wire for general build-up
- Can be flame hardened to 38 Rockwell C (R_c)
- Used on mining components such as cable drums, sheaves, gears and shafts

TYPICAL APPLICATIONS

- Caster rolls

RECOMMENDED FLUX

Primary Flux _____	Secondary Flux ⁽¹⁾ _____
801	802, 880

⁽¹⁾ 802 and 860 standard flux are not sized for semiautomatic applications; however, they can be ordered in special sizing by contacting your Lincoln Electric representative.

DIAMETERS / PACKAGING

Diameter in (mm)	50 lb (22.7 kg) Coil	600 lb (272 kg) Speed-Feed® Drum
3/32 (2.4)	ED015265	ED015532
1/8 (3.2)	ED015266	ED015405

MECHANICAL PROPERTIES⁽¹⁾

Rockwell Hardness (R _c)
17 - 21

DEPOSIT COMPOSITION⁽¹⁾

With Recommended Neutral Flux				
%C	%Mn	%Si	%Cr	%Mo
0.12	1.10	0.30	0.80	0.20

TYPICAL OPERATING PROCEDURES

Diameter, Polarity ESO - in (mm)	Wire Feed Speed m/min (in/min)	Voltage (Volts)	Approx. Current (Amps)	Deposition Rate kg/hr (lb/hr)
3/32 in (2.4 mm), DC+ 3/4 (20)	1.7 (65)	24	300	2.9 (6.5)
	3.0 (120)	28	410	5.4 (12.0)
	4.4 (175)	31	520	7.9 (17.5)
1/8 in (3.2 mm), DC+ 3/4 (20)	1.5 (60)	26	350	3.9 (8.5)
	2.5 (100)	28	465	7.2 (16.0)
	3.6 (140)	30	590	10.6 (23.5)

⁽¹⁾ Composition and properties depend upon dilution. Single layer deposit properties depend upon base metal and/or build-up material.

IMPORTANT: SPECIAL VENTILATION AND/OR EXHAUST REQUIRED

Fumes from the normal use of some welding products can contain significant quantities of components - such as chromium and manganese - which can lower the 5.0 mg/m³ maximum exposure guideline for general welding fume. BEFORE USE, READ AND UNDERSTAND THE SAFETY DATA SHEET (SDS) FOR THIS PRODUCT AND SPECIFIC INFORMATION PRINTED ON THE PRODUCT CONTAINER.

LINCORE[®] 8620

Roll Rebuilding, Build Up

KEY FEATURES

- Metal-cored wire for build-up on worn rolls
- A little softer than Lincore[®] 20 for easier machining

TYPICAL APPLICATIONS

- Caster rolls

RECOMMENDED FLUX

Primary Flux	Secondary Flux ⁽¹⁾
801	802, 880

⁽¹⁾ 802 and 880 standard flux are not sized for semiautomatic applications; however, they can be ordered in special sizing by contacting your Lincoln Electric representative.

DIAMETERS / PACKAGING

Diameter in (mm)	50 lb (22.7 kg) Coil	600 lb (272 kg) Speed-Feed [®] Drum
1/8 (3.2)	ED020788	ED020791

MECHANICAL PROPERTIES⁽¹⁾

Rockwell Hardness [R _c]
16 - 20

DEPOSIT COMPOSITION⁽¹⁾

With Recommended Neutral Flux					
%C	%Mn	%Si	%Cr	%Ni	%Mo
0.09	0.80	0.30	0.45	0.55	0.15

TYPICAL OPERATING PROCEDURES

Diameter, Polarity ESO - in (mm)	Wire Feed Speed m/min (in/min)	Voltage (Volts)	Approx. Current (Amps)	Deposition Rate kg/hr (lb/hr)
1/8 in (3.2 mm), DC+ 3/4 (20)	1.5 (60)	26	400	4.7 (10.4)
	2.5 (100)	28	550	7.8 (17.3)
	3.6 (140)	30	680	11.0 (24.2)

⁽¹⁾ Composition and properties depend upon dilution. Single layer deposit properties depend upon base metal and/or build-up material.

IMPORTANT: SPECIAL VENTILATION AND/OR EXHAUST REQUIRED

Fumes from the normal use of some welding products can contain significant quantities of components - such as chromium and manganese - which can lower the 5.0 mg/m³ maximum exposure guideline for general welding fume. BEFORE USE, READ AND UNDERSTAND THE SAFETY DATA SHEET (SDS) FOR THIS PRODUCT AND SPECIFIC INFORMATION PRINTED ON THE PRODUCT CONTAINER.

LINCORE[®] 410

Roll Rebuilding, Metal-to-Metal

KEY FEATURES

- Metal-cored wire with a 410 martensitic stainless steel deposit
- Low carbon content and high corrosion resistance
- Soft and easily machined

TYPICAL APPLICATIONS

- Caster rolls

RECOMMENDED FLUX

Primary Flux	Secondary Flux ⁽¹⁾
801	802

⁽¹⁾ 802 and 860 standard flux are not sized for semiautomatic applications; however, they can be ordered in special sizing by contacting your Lincoln Electric representative.

DIAMETERS / PACKAGING

Diameter in (mm)	50 lb (22.7 kg) Coil	600 lb (272 kg) Speed-Feed [®] Drum
3/32 (2.4)	ED018583	
5/32 (4.0)		ED018588

MECHANICAL PROPERTIES⁽¹⁾

Rockwell Hardness (R _c)
27 - 32

DEPOSIT COMPOSITION⁽¹⁾

With Recommended Neutral Flux				
%C	%Mn	%Si	%Cr	%Ni
0.08	0.80	0.40	12.50	0.20

TYPICAL OPERATING PROCEDURES

Diameter, Polarity ESO - in (mm)	Wire Feed Speed m/min (in/min)	Voltage (Volts)	Approx. Current (Amps)	Deposition Rate kg/hr (lb/hr)
3/32 in (2.4 mm), DC+ 3/4 (20)	1.7 (65)	24	250	2.9 (6.5)
	3.0 (120)	28	375	5.4 (12.0)
	4.4 (175)	31	450	7.9 (17.5)
5/32 in (4.0 mm), DC+ 1 1/2 (38)	1.4 (55)	27	475	5.9 (13.1)
	2.2 (85)	30	650	9.2 (20.2)
	2.9 (115)	32	800	12.4 (27.3)

⁽¹⁾ Composition and properties depend upon dilution. Single layer deposit properties depend upon base metal and/or build-up material.

<p>IMPORTANT: SPECIAL VENTILATION AND/OR EXHAUST REQUIRED</p> <p>Fumes from the normal use of some welding products can contain significant quantities of components - such as chromium and manganese - which can lower the 5.0 mg/m³ maximum exposure guideline for general welding fume.</p> <p>BEFORE USE, READ AND UNDERSTAND THE SAFETY DATA SHEET (SDS) FOR THIS PRODUCT AND SPECIFIC INFORMATION PRINTED ON THE PRODUCT CONTAINER.</p>
--

LINCORE[®] 410NiMo

Roll Rebuilding, Metal-to-Metal

KEY FEATURES

- Metal-cored wire with low carbon deposit, which forms softer, tougher martensite than other roll alloys

TYPICAL APPLICATIONS

- Caster rolls

RECOMMENDED FLUX

Primary Flux	Secondary Flux ⁽¹⁾
801	802

⁽¹⁾ 802 and 860 standard flux are not sized for semiautomatic applications; however, they can be ordered in special sizing by contacting your Lincoln Electric representative.

DIAMETERS / PACKAGING

Diameter in (mm)	50 lb (22.7 kg) Coil	600 lb (272 kg) Speed-Feed [®] Drum
3/32 (2.4)	ED018589	
1/8 (3.2)	ED018590	ED018593
5/32 (4.0)		ED018594

MECHANICAL PROPERTIES⁽¹⁾

Rockwell Hardness (R _c)
32 - 40

DEPOSIT COMPOSITION⁽¹⁾

With Recommended Neutral Flux					
%C	%Mn	%Si	%Cr	%Ni	%Mo
0.05	0.80	0.50	13.00	2.00	1.00

TYPICAL OPERATING PROCEDURES

Diameter, Polarity ESO - in (mm)	Wire Feed Speed m/min (in/min)	Voltage (Volts)	Approx. Current (Amps)	Deposition Rate kg/hr (lb/hr)
3/32 in (2.4 mm), DC+ 1 1/2 (38)	1.7 (65)	24	250	2.6 (5.8)
	3.0 (120)	28	325	4.9 (10.7)
	4.4 (175)	31	425	7.1 (15.6)
1/8 in (3.2 mm), DC+ 1 5/8 (40)	1.5 (60)	26	325	4.3 (9.4)
	3.6 (140)	30	575	9.9 (21.8)
5/32 in (4.0 mm), DC+ 1 5/8 (40 mm)	1.4 (55)	27	440	5.8 (12.8)
	2.2 (85)	30	575	9.0 (19.8)
	2.9 (115)	32	700	12.2 (26.8)

⁽¹⁾ Composition and properties depend upon dilution. Single layer deposit properties depend upon base metal and/or build-up material.

IMPORTANT: SPECIAL VENTILATION AND/OR EXHAUST REQUIRED

Fumes from the normal use of some welding products can contain significant quantities of components - such as chromium and manganese - which can lower the 5.0 mg/m³ maximum exposure guideline for general welding fume. BEFORE USE, READ AND UNDERSTAND THE SAFETY DATA SHEET (SDS) FOR THIS PRODUCT AND SPECIFIC INFORMATION PRINTED ON THE PRODUCT CONTAINER.

LINCORE® 423L

Roll Rebuilding, Metal-to-Metal

KEY FEATURES

- Metal-cored wire, provides a softer "as-welded" deposit than Lincore® 420
- More resistance to softening during tempering above 482°C (900°F)

TYPICAL APPLICATIONS

- Caster rolls

RECOMMENDED FLUX

Primary Flux ⁽¹⁾	802
-----------------------------	-----

⁽¹⁾ 802 and 860 standard flux are not sized for semiautomatic applications; however, they can be ordered in special sizing by contacting your Lincoln Electric representative.

DIAMETERS / PACKAGING

Diameter in (mm)	600 lb (272 kg) Speed-Feed® Drum
1/8 (3.2)	ED018551

MECHANICAL PROPERTIES⁽¹⁾

Rockwell Hardness (R _c)
41-47

DEPOSIT COMPOSITION⁽¹⁾

With Recommended Neutral Flux						
%C	%Mn	%Si	%Cr	%Ni	%Mo	%V
0.15	1.20	0.40	11.50	2.00	1.00	0.15

TYPICAL OPERATING PROCEDURES

Diameter, Polarity ESO - in (mm)	Wire Feed Speed m/min (in/min)	Voltage (Volts)	Approx. Current (Amps)	Deposition Rate kg/hr (lb/hr)
1/8 in (3.2 mm), DC+	1.5 (60)	26	350	4.2 (9.3)
	2.5 (100)	28	500	7.0 (15.5)
	3.6 (140)	30	610	9.8 (21.7)

⁽¹⁾ Composition and properties depend upon dilution. Single layer deposit properties depend upon base metal and/or build-up material.

IMPORTANT: SPECIAL VENTILATION AND/OR EXHAUST REQUIRED

Fumes from the normal use of some welding products can contain significant quantities of components - such as chromium and manganese - which can lower the 5.0 mg/m³ maximum exposure guideline for general welding fume. BEFORE USE, READ AND UNDERSTAND THE SAFETY DATA SHEET (SDS) FOR THIS PRODUCT AND SPECIFIC INFORMATION PRINTED ON THE PRODUCT CONTAINER.

LINCORE® 423CR

Roll Rebuilding, Metal-to-Metal

KEY FEATURES

- Metal-cored wire with a higher chrome deposit than Lincore® 423L for improved corrosion resistance

TYPICAL APPLICATIONS

- Caster rolls

RECOMMENDED FLUX

Primary Flux⁽¹⁾ _____ 802

⁽¹⁾ 802 and 860 standard flux are not sized for semiautomatic applications; however, they can be ordered in special sizing by contacting your Lincoln Electric representative.

DIAMETERS / PACKAGING

Diameter in (mm)	600 lb (272 kg) Speed-Feed® Drum
3/32 (2.4)	ED018557
1/8 (3.2)	

MECHANICAL PROPERTIES⁽¹⁾

Rockwell Hardness (R _c)
41-47

DEPOSIT COMPOSITION⁽¹⁾

With Recommended Neutral Flux						
%C	%Mn	%Si	%Cr	%Ni	%Mo	%V
0.15	1.20	0.40	13.50	2.00	1.00	0.15

TYPICAL OPERATING PROCEDURES

Diameter, Polarity ESO - in (mm)	Wire Feed Speed m/min (in/min)	Voltage (Volts)	Approx. Current (Amps)	Deposition Rate kg/hr (lb/hr)
3/32 in (2.4 mm), DC+ 1 1/2 (38)	1.7 (65)	24	250	2.7 (6.0)
	3.0 (120)	28	350	5.0 (11.0)
	4.4 (175)	31	450	7.3 (16.0)
1/8 in (3.2 mm), DC+ 1 5/8 (40)	1.5 (60)	26	375	4.5 (9.9)
	2.5 (100)	28	540	7.5 (16.5)
	3.6 (140)	30	640	10.5 (23.1)

⁽¹⁾ Composition and properties depend upon dilution. Single layer deposit properties depend upon base metal and/or build-up material.

IMPORTANT: SPECIAL VENTILATION AND/OR EXHAUST REQUIRED

Fumes from the normal use of some welding products can contain significant quantities of components - such as chromium and manganese - which can lower the 5.0 mg/m³ maximum exposure guideline for general welding fume. BEFORE USE, READ AND UNDERSTAND THE SAFETY DATA SHEET (SDS) FOR THIS PRODUCT AND SPECIFIC INFORMATION PRINTED ON THE PRODUCT CONTAINER.

LINCORE[®] 420

Roll Rebuilding, Metal-to-Metal

KEY FEATURES

- Metal-cored wire that is most widely used for caster roll rebuilding

TYPICAL APPLICATIONS

- Caster rolls

RECOMMENDED FLUX

Primary Flux	Secondary Flux
801	802

DIAMETERS / PACKAGING

Diameter in (mm)	50 lb (22.7 kg) Coil	600 lb (272 kg) Speed-Feed [®] Drum
3/32 (2.4)	ED015260	ED015261
1/8 (3.2)	ED015262	ED015268
5/32 (4.0)		ED015264

MECHANICAL PROPERTIES⁽¹⁾

Rockwell Hardness (R _c)
46-50

DEPOSIT COMPOSITION⁽¹⁾

With Recommended Neutral Flux			
%C	%Mn	%Si	%Cr
0.20	1.20	0.50	12.00

TYPICAL OPERATING PROCEDURES

Diameter, Polarity ESO - in (mm)	Wire Feed Speed m/min (in/min)	Voltage (Volts)	Approx. Current (Amps)	Deposition Rate kg/hr (lb/hr)
3/32 in (2.4 mm), DC+ 1 1/2 (38)	1.7 (65)	24	250	2.9 (6.5)
	3.0 (120)	28	375	5.4 (12.0)
	4.4 (175)	31	450	7.9 (17.5)
1/8 in (3.2 mm), DC+ 1 5/8 (40)	1.5 (60)	26	350	4.3 (9.5)
	2.5 (100)	28	500	7.2 (15.8)
	3.6 (140)	30	625	10.0 (22.1)
5/32 in (4.0 mm), DC+ 1 5/8 (40)	1.4 (55)	27	475	5.9 (13.1)
	2.2 (85)	30	650	9.2 (20.2)
	2.9 (115)	32	800	12.4 (27.3)

⁽¹⁾ Composition and properties depend upon dilution. Single layer deposit properties depend upon base metal and/or build-up material.

IMPORTANT: SPECIAL VENTILATION AND/OR EXHAUST REQUIRED

Fumes from the normal use of some welding products can contain significant quantities of components - such as chromium and manganese - which can lower the 5.0 mg/m³ maximum exposure guideline for general welding fume. BEFORE USE, READ AND UNDERSTAND THE SAFETY DATA SHEET (SDS) FOR THIS PRODUCT AND SPECIFIC INFORMATION PRINTED ON THE PRODUCT CONTAINER.

LINCORE® 414N

Roll Rebuilding, Metal-to-Metal

OPERATING PROCEDURES

Current, Amp. DC+:	400-500
Voltage:	26-30
Wire Extension:	1 1/4" -1 1/2"

TYPICAL APPLICATIONS

- Continuous caster rolls

RECOMMENDED FLUX

Primary Flux	Secondary Flux
802	801

DIAMETERS / PACKAGING

Diameter in (mm)	50 lb (22.7 kg) Coil	600 lb (272 kg) Speed-Feed® Drum
1/8 (3.2)	ED034257	ED034258

DEPOSIT COMPOSITION⁽¹⁾

%C	%Mn	%Cr	%Si	%Mo	%Ni	%N	Avg HRC
0.06	1.20	12.6	0.40	1.60	3.50	0.09	43

⁽¹⁾ Composition and properties depend upon dilution. Single layer deposit properties depend upon base metal and/or build-up material.

IMPORTANT: SPECIAL VENTILATION AND/OR EXHAUST REQUIRED

Fumes from the normal use of some welding products can contain significant quantities of components - such as chromium and manganese - which can lower the 5.0 mg/m³ maximum exposure guideline for general welding fume. BEFORE USE, READ AND UNDERSTAND THE SAFETY DATA SHEET (SDS) FOR THIS PRODUCT AND SPECIFIC INFORMATION PRINTED ON THE PRODUCT CONTAINER.

LINCORE® 423N

Roll Rebuilding, Metal-to-Metal

OPERATING PROCEDURES

Current, Amp. DC+:	400-500
Voltage:	26-30
Wire Extension:	1 1/4" -1 1/2"

TYPICAL APPLICATIONS

- Higher wear continuous caster rolls

RECOMMENDED FLUX

Primary Flux	Secondary Flux
802	801

DIAMETERS / PACKAGING

Diameter in (mm)	50 lb (22.7 kg) Coil	600 lb (272 kg) Speed-Feed® Drum
1/8 (3.2)	ED036012	ED036013

DEPOSIT COMPOSITION⁽¹⁾

%C	%Mn	%Cr	%Si	%Mo	%Ni	%V	%W	%N	Avg HRC
0.06	1.86	11.70	0.62	1.40	3.70	0.29	0.27	0.08	42

⁽¹⁾ Composition and properties depend upon dilution. Single layer deposit properties depend upon base metal and/or build-up material.

IMPORTANT: SPECIAL VENTILATION AND/OR EXHAUST REQUIRED

Fumes from the normal use of some welding products can contain significant quantities of components - such as chromium and manganese - which can lower the 5.0 mg/m³ maximum exposure guideline for general welding fume. BEFORE USE, READ AND UNDERSTAND THE SAFETY DATA SHEET (SDS) FOR THIS PRODUCT AND SPECIFIC INFORMATION PRINTED ON THE PRODUCT CONTAINER.

LINCORE® 96-S

Roll Rebuilding, Metal-to-Metal

KEY FEATURES

- Metal-cored wire which produces a high carbon, 420 stainless steel deposit
- Use where a higher hardness is required
- Can be used on work rolls and backup rolls when water spray causes pitting on tool steel deposits

TYPICAL APPLICATIONS

- Caster rolls

RECOMMENDED FLUX

Primary Flux	Secondary Flux
801	802

DIAMETERS / PACKAGING

Diameter in (mm)	600 lb (272 kg) Speed-Feed® Drum
3/32 [2.4]	ED018574
1/8 [3.2]	ED018575
5/32 [4.0]	ED018576

MECHANICAL PROPERTIES⁽¹⁾

Rockwell Hardness (R _c)
48-54

DEPOSIT COMPOSITION⁽¹⁾

With Recommended Neutral Flux			
%C	%Mn	%Si	%Cr
0.23	1.20	0.40	13.00

TYPICAL OPERATING PROCEDURES

Diameter, Polarity ESO - in (mm)	Wire Feed Speed m/min (in/min)	Voltage (Volts)	Approx. Current (Amps)	Deposition Rate kg/hr (lb/hr)
3/32 in [2.4 mm], DC+ 1 1/2 [38]	1.7 [65]	24	250	2.6 [5.7]
	2.5 [100]	28	525	7.1 [15.7]
	4.4 [175]	31	450	7.0 [15.5]
1/8 in [3.2 mm], DC+ 1 5/8 [40]	1.5 [60]	26	360	4.3 [9.4]
	2.5 [100]	28	525	7.1 [15.7]
	3.6 [140]	30	635	10.0 [22.0]
5/32 in [4.0 mm], DC+ 1 5/8 [40]	1.4 [55]	27	450	5.9 [12.9]
	2.2 [85]	30	650	9.1 [20.0]
	2.9 [115]	32	775	12.3 [27.1]

⁽¹⁾ Composition and properties depend upon dilution. Single layer deposit properties depend upon base metal and/or build-up material.

IMPORTANT: SPECIAL VENTILATION AND/OR EXHAUST REQUIRED

Fumes from the normal use of some welding products can contain significant quantities of components - such as chromium and manganese - which can lower the 5.0 mg/m³ maximum exposure guideline for general welding fume. BEFORE USE, READ AND UNDERSTAND THE SAFETY DATA SHEET (SDS) FOR THIS PRODUCT AND SPECIFIC INFORMATION PRINTED ON THE PRODUCT CONTAINER.

LINCORE[®] 102W

Roll Rebuilding, Metal-to-Metal

KEY FEATURES

- Metal-cored wire which produces a tool steel deposit that retains hardness at high working temperatures
- Used for guide rolls, and work rolls
- Can also be used as the seat on blast furnace bells and hoppers

TYPICAL APPLICATIONS

- Work rolls
- Metal-to-metal sliding wear (where minimal or no lubrication is present)

RECOMMENDED FLUX

Primary Flux ⁽¹⁾	Secondary Flux
802	801

⁽¹⁾ 802 and 860 standard flux are not sized for semiautomatic applications; however, they can be ordered in special sizing by contacting your Lincoln Electric representative.

DIAMETERS / PACKAGING

Diameter in (mm)	50 lb (22.7 kg) Coil	600 lb (272 kg) Speed-Feed [®] Drum
3/32 (2.4)	ED018578	ED018580
1/8 (3.2)		ED018581
5/32 (4.0)		ED018582

MECHANICAL PROPERTIES⁽¹⁾

Rockwell Hardness (R _c)
48-54

DEPOSIT COMPOSITION⁽¹⁾

With Recommended Neutral Flux						
%C	%Mn	%Si	%Cr	%Mo	%V	%W
0.28	1.50	0.40	6.50	1.00	0.15	1.00

TYPICAL OPERATING PROCEDURES

Diameter, Polarity ESO - in (mm)	Wire Feed Speed m/min (in/min)	Voltage (Volts)	Approx. Current (Amps)	Deposition Rate kg/hr (lb/hr)
3/32 in (2.4 mm), DC+ 1 5/8 (40)	1.7 (65)	24	240	2.8 (6.2)
	3.0 (120)	28	400	5.2 (11.5)
	4.4 (175)	31	500	7.6 (16.8)
1/8 in (3.2 mm), DC+ 1 5/8 (40)	1.5 (60)	26	390	4.4 (9.8)
	2.5 (100)	28	540	7.4 (16.4)
	3.6 (140)	30	680	10.4 (23.0)
5/32 in (4.0 mm), DC+ 1 5/8 (40)	1.4 (55)	27	500	6.4 (14.2)
	2.2 (85)	30	685	9.9 (21.9)
	2.9 (115)	32	850	13.4 (29.6)

⁽¹⁾ Composition and properties depend upon dilution. Single layer deposit properties depend upon base metal and/or build-up material.

IMPORTANT: SPECIAL VENTILATION AND/OR EXHAUST REQUIRED

Fumes from the normal use of some welding products can contain significant quantities of components - such as chromium and manganese - which can lower the 5.0 mg/m³ maximum exposure guideline for general welding fume. BEFORE USE, READ AND UNDERSTAND THE SAFETY DATA SHEET (SDS) FOR THIS PRODUCT AND SPECIFIC INFORMATION PRINTED ON THE PRODUCT CONTAINER.

LINCORE[®] 102HC

Roll Rebuilding, Metal-to-Metal

KEY FEATURES

- Metal-cored wire with a higher carbon content than Lincore[®] 102W
- Will give a higher hardness tool steel deposit
- Deposit is "hot" [above 204°C [400°F]] machinable, for easy sizing after welding

TYPICAL APPLICATIONS

- Work rolls
- Metal-to-metal sliding wear (where minimal or no lubrication is present)

RECOMMENDED FLUX

Primary Flux ⁽¹⁾	Secondary Flux
802	801

⁽¹⁾ 802 and 860 standard flux are not sized for semiautomatic applications; however, they can be ordered in special sizing by contacting your Lincoln Electric representative.

DIAMETERS / PACKAGING

Diameter in (mm)	50 lb (22.7 kg) Coil	600 lb (272 kg) Speed-Feed [®] Drum
3/32 (2.4)	ED026085	ED026086
1/8 (3.2)		ED026087

MECHANICAL PROPERTIES⁽¹⁾

Rockwell Hardness (R _c)
54 - 60

DEPOSIT COMPOSITION⁽¹⁾

With Recommended Neutral Flux						
%C	%Mn	%Si	%Cr	%Mo	%V	%W
0.40	2.10	1.60	6.70	1.60	0.20	1.30

TYPICAL OPERATING PROCEDURES

Diameter, Polarity ESO - in (mm)	Wire Feed Speed m/min (in/min)	Voltage (Volts)	Approx. Current (Amps)	Deposition Rate kg/hr (lb/hr)
3/32 in (2.4 mm), DC+ 1 1/2 (38)	1.7 (65)	24	240	2.8 (6.2)
	3.0 (120)	28	400	5.2 (11.5)
	4.4 (175)	31	500	7.6 (16.8)
1/8 in (3.2 mm), DC+ 1 5/8 (40)	1.5 (60)	26	390	4.4 (9.8)
	2.5 (100)	28	540	7.4 (16.4)
	3.6 (140)	30	680	10.4 (23.0)

⁽¹⁾ Composition and properties depend upon dilution. Single layer deposit properties depend upon base metal and/or build-up material.

IMPORTANT: SPECIAL VENTILATION AND/OR EXHAUST REQUIRED

Fumes from the normal use of some welding products can contain significant quantities of components - such as chromium and manganese - which can lower the 5.0 mg/m³ maximum exposure guideline for general welding fume. BEFORE USE, READ AND UNDERSTAND THE SAFETY DATA SHEET (SDS) FOR THIS PRODUCT AND SPECIFIC INFORMATION PRINTED ON THE PRODUCT CONTAINER.

LINCORE® BU-G

Build-Up

KEY FEATURES

- Delivers deposits with moderate hardness for build-up or as final overlay
- Provides some resistance to metal-to-metal wear and moderate impact
- Unlimited layers with proper preheat and interpass temperatures and procedures

WELDING POSITIONS

Flat & Horizontal

TYPICAL APPLICATIONS

- Rolls
- Shafts
- Pump and shovel parts
- Pulverizer
- Plows

SHIELDING GAS

75-90% Argon / Balance CO₂

98% Argon / 2% O₂

DIAMETERS / PACKAGING

Diameter in (mm)	25 lb (11.3 kg) Plastic Spool	50 lb (22.7 kg) Coil	50 lb (22.7 kg) Fiber Spool
0.045 (1.1)	ED029079		
1/16 (1.6)	ED029080	ED037318	ED037800

MECHANICAL PROPERTIES⁽¹⁾

As-Welded		Rockwell Hardness (R _c)	Work-Hardened
21 - 33			40 - 42

DEPOSIT COMPOSITION⁽¹⁾

On Carbon Steel	%C	%Mn	%Si	%Cr	%Mo
4 Layers	0.08	1.60	0.50	0.90	0.30

TYPICAL OPERATING PROCEDURES

Diameter, Polarity, ESO - in (mm) Shielding Gas	Wire Feed Speed m/min (in/min)	Voltage (Volts)	Approx. Current (Amps)	Deposition Rate kg/hr (lb/hr)
0.045 in (1.1 mm), DC+, 5/8 (16) 75% Ar/25% CO ₂	5.1 (200)	29	175	1.7 (3.7)
	7.6 (300)	30	240	2.6 (5.8)
	10.2 (400)	32	300	3.6 (7.9)
0.045 in (1.1 mm), DC+, 3/4 (20) 90% Ar/10% CO ₂	5.1 (200)	25	215	2.1 (4.7)
	7.6 (300)	27	250	3.1 (6.9)
	10.2 (400)	29	285	4.1 (9.1)
0.045 in (1.1 mm), DC+, 3/4 (20) 98% Ar/2% O ₂	5.1 (200)	25	210	2.0 (4.5)
	7.6 (300)	26	280	3.2 (7.1)
	10.2 (400)	28	315	4.4 (9.7)
1/16 in (1.6 mm), DC+, 3/4 (20) 75% Ar/25% CO ₂	3.8 (150)	27	280	2.8 (6.1)
	6.4 (250)	29	370	4.8 (10.5)
	8.9 (350)	31	460	6.8 (14.9)
1/16 in (1.6 mm), DC+, 3/4 (20) 90% Ar/10% CO ₂	3.8 (150)	25	270	2.6 (5.7)
	6.4 (250)	27	375	4.9 (10.8)
	8.9 (350)	29	470	7.2 (15.9)
1/16 in (1.6 mm), DC+, 3/4 (20) 98% Ar/2% O ₂	3.8 (150)	24	290	2.8 (6.1)
	6.4 (250)	26	390	5.0 (11.1)
	8.9 (350)	28	490	7.3 (16.1)

⁽¹⁾Composition and properties depend upon dilution. Single layer deposit properties depend upon base metal and/or build-up material.

IMPORTANT: SPECIAL VENTILATION AND/OR EXHAUST REQUIRED

Fumes from the normal use of some welding products can contain significant quantities of components - such as chromium and manganese - which can lower the 5.0 mg/m³ maximum exposure guideline for general welding fume. BEFORE USE, READ AND UNDERSTAND THE SAFETY DATA SHEET (SDS) FOR THIS PRODUCT AND SPECIFIC INFORMATION PRINTED ON THE PRODUCT CONTAINER.

LINCORE® BU

Build-Up

KEY FEATURES

- Provides a tough machinable deposit for build-up or final overlay
- Delivers non-severe metal-to-metal wear with outstanding crack resistance
- Ideal for rebuilding worn parts to near final dimensions before applying final hardfacing layers which are more wear resistant
- Can also be used as the final hardfacing layer for non-severe metal-to-metal wear applications
- Unlimited layers with proper preheat and interpass temperatures and procedures

TYPICAL APPLICATIONS

- Cable sheaves
- Crane wheels
- Drums and pulleys

WELDING POSITIONS

Flat & Horizontal

DIAMETERS / PACKAGING

Diameter in (mm)	25 lb (11.3 kg) Steel Spool	50 lb (22.7 kg) Coil
5/64 (2.0)	ED031115	ED022064
7/64 (2.8)		ED022065

MECHANICAL PROPERTIES⁽¹⁾

	Rockwell Hardness (R _c)	
	As-Welded	Work-Hardened
	78 - 90	86 - 98

DEPOSIT COMPOSITION⁽¹⁾

	%C	%Mn	%Si	%Al
6 Layers	0.24	0.50	0.25	1.50

TYPICAL OPERATING PROCEDURES

Diameter, Polarity ESO - in (mm)	Wire Feed Speed m/min (in/min)	Voltage (Volts)	Approx. Current (Amps)	Deposition Rate kg/hr (lb/hr)
5/64 in (2.0 mm), DC+ 2 (50)	5.1 (200)	29	280	4.6 (10.1)
	6.1 (240)	30	315	5.5 (12.1)
	6.6 (260)	30	330	6.1 (13.2)
	7.6 (300)	31	350	6.9 (15.2)
7/64 in (2.8 mm), DC+ 2 1/2 (64)	3.4 (135)	26	360	5.7 (12.6)
	3.8 (150)	27	385	6.3 (13.9)
	4.4 (175)	28	420	7.3 (16.0)
	5.1 (200)	29	450	8.2 (18.1)
	5.9 (235)	30	470	9.6 (21.1)

⁽¹⁾ Composition and properties depend upon dilution. Single layer deposit properties depend upon base metal and/or build-up material.

<p>IMPORTANT: SPECIAL VENTILATION AND/OR EXHAUST REQUIRED</p> <p>Fumes from the normal use of some welding products can contain significant quantities of components - such as chromium and manganese - which can lower the 5.0 mg/m³ maximum exposure guideline for general welding fume.</p> <p>BEFORE USE, READ AND UNDERSTAND THE SAFETY DATA SHEET (SDS) FOR THIS PRODUCT AND SPECIFIC INFORMATION PRINTED ON THE PRODUCT CONTAINER.</p>
--

LINCORE® 33

Build-Up

KEY FEATURES

- Delivers tough machinable deposits for build-up or final overlay intended for metal-to-metal wear
- Use for build-up of steel mill parts such as rougher couplings
- Build-up deposit on carbon steel and low alloy steel base metals
- It is ideal for rebuilding worn parts to near final dimensions before applying final hardfacing layers which are more wear resistant
- Unlimited layers with proper preheat and interpass temperatures and procedures

TYPICAL APPLICATIONS

- Tractor rolls and idlers
- Mill and crusher hammers
- Shovel parts
- Dredge pumps
- Mine car wheels

WELDING POSITIONS

Flat & Horizontal

DIAMETERS / PACKAGING

Diameter in (mm)	14 lb [6.4 kg] Coil 56 lb [25.4 kg] Master Carton	25 lb [11.3 kg] Steel Spool	50 lb [22.7 kg] Coil
0.045 (1.2)	ED011237	ED031116	ED011238 ED011240
1/16 (1.6)		ED031117	
5/64 (2.0)		ED031118	
7/64 (2.8)			

MECHANICAL PROPERTIES⁽¹⁾

No. of Layers	Rockwell Hardness (R _c)		
	As-Welded	Work-Hardened	Flame-Hardened / Water Quenched
1	14-30	28-34	—
2	26-32	32-36	38-42
3	25-34	35-38	—

DEPOSIT COMPOSITION⁽¹⁾

	%C	%Mn	%Si	%Al	%Cr	%S	%P
3 Layers (0.045 in & 1/16 in)	0.11-0.18	1.8-2.1	0.50-0.75	1.6-1.9	1.2-1.4	0.002-0.005	0.004-0.012
3 Layers (5/64 in & 7/64 in)	0.13-0.15	2.1-2.3	0.45-0.60	1.45-1.70	1.1-1.4	0.002-0.005	0.004-0.008

TYPICAL OPERATING PROCEDURES

Diameter, Polarity ESO - in (mm)	Wire Feed Speed m/min (in/min)	Voltage (Volts)	Approx. Current (Amps)	Deposition Rate kg/hr (lb/hr)
0.045 in (1.1 mm), DC+ 1 3/4 (45)	5.1 (200)	25	80	1.5 (3.3)
	8.9 (350)	28	130	2.7 (6.0)
	12.7 (500)	31	150	3.9 (8.7)
1/16 in (1.6 mm), DC+ 1 3/4 (45)	3.8 (150)	26	125	2.1 (4.6)
	6.4 (250)	29	180	3.5 (7.8)
	8.9 (350)	32	225	5.0 (11.1)
5/64 in (2.0 mm), DC+ 2 (50)	3.2 (125)	23	200	3.1 (6.9)
	5.1 (200)	27	290	4.9 (10.8)
	6.4 (250)	29	325	6.1 (21.1)
7/64 in (2.8 mm), DC+ 2 1/2 (64)	3.4 (135)	26	360	5.7 (12.6)
	4.4 (175)	28	420	7.3 (16.0)
	6.0 (235)	30	470	9.6 (21.1)

⁽¹⁾ Composition and properties depend upon dilution. Single layer deposit properties depend upon base metal and/or build-up material.

<p>IMPORTANT: SPECIAL VENTILATION AND/OR EXHAUST REQUIRED</p> <p>Fumes from the normal use of some welding products can contain significant quantities of components - such as chromium and manganese - which can lower the 5.0 mg/m³ maximum exposure guideline for general welding fume. BEFORE USE, READ AND UNDERSTAND THE SAFETY DATA SHEET (SDS) FOR THIS PRODUCT AND SPECIFIC INFORMATION PRINTED ON THE PRODUCT CONTAINER.</p>
--

LINCORE® 40-0

Metal-to-Metal

KEY FEATURES

- Higher hardness for metal-to-metal wear and mild abrasion
- Used on transfer rollers and guides, crane wheels and shafts
- Can be used on low carbon and low alloy steels
- Unlimited layers with proper preheat and interpass temperatures and procedures

TYPICAL APPLICATIONS

- Tractor rolls
- Mine car wheels
- Guide rollers
- Bucket links and bases
- Actuating cams

WELDING POSITIONS

Flat & Horizontal

DIAMETERS / PACKAGING

Diameter in (mm)	25 lb (11.3 kg) Steel Spool	50 lb (22.7 kg) Coil
5/64 [2.0]	ED031119	ED025907

MECHANICAL PROPERTIES⁽¹⁾

	Rockwell Hardness (R _c)		
	1 Layer	2 Layers	3 Layers
	36	41	38

DEPOSIT COMPOSITION⁽¹⁾

	%C	%Mn	%Si	%Al	%Cr	%Mo
1 Layer	0.18	1.25	0.53	1.34	2.51	0.32
2 Layers	0.20	1.46	0.67	1.72	3.25	0.42
3 Layers	0.21	1.55	0.76	1.97	3.52	0.46

TYPICAL OPERATING PROCEDURES

Diameter, Polarity ESO - in (mm)	Wire Feed Speed m/min (in/min)	Voltage (Volts)	Approx. Current (Amps)	Deposition Rate kg/hr (lb/hr)
5/64 in [2.0 mm], DC+ 1 3/4 [45]	3.2 [125]	24	218	3.2 [7.0]
	5.1 [200]	27	282	5.0 [11.1]
	6.4 [250]	30	327	6.3 [13.9]

⁽¹⁾ Composition and properties depend upon dilution. Single layer deposit properties depend upon base metal and/or build-up material.

NOTE: Area to be overlaid should be clean and free of rust, oil, etc. Any previous hardfacing deposit that has been embrittled by severe work hardening should be removed. Cracks and other irregularities should be properly repaired.

Cold parts should be warmed to at least 250°C (750°F). Higher preheat of 150 - 260°C (300 - 500°F) may be necessary on thick parts or heavy sections. Interpass temperature between 150°C (300°F) and 200°C (400°F) do not affect the hardness of Lincore® 40-0 significantly.

<p>IMPORTANT: SPECIAL VENTILATION AND/OR EXHAUST REQUIRED</p> <p>Fumes from the normal use of some welding products can contain significant quantities of components - such as chromium and manganese - which can lower the 5.0 mg/m³ maximum exposure guideline for general welding fume.</p> <p>BEFORE USE, READ AND UNDERSTAND THE SAFETY DATA SHEET (SDS) FOR THIS PRODUCT AND SPECIFIC INFORMATION PRINTED ON THE PRODUCT CONTAINER.</p>
--

LINCORE[®] 55

Metal-to-Metal

KEY FEATURES

- Delivers a deposit which resists metal-to-metal rolling or sliding wear as well as mild abrasion
- To be used on carbon steel, low alloy steel and manganese steel
- Unlimited layers with proper preheat and interpass temperatures and procedures

TYPICAL APPLICATIONS

- Crane wheels
- Skip guides
- Blower blades
- Cams and transfer tables
- Rail ends

WELDING POSITIONS

Flat & Horizontal

DIAMETERS / PACKAGING

Diameter in (mm)	14 lb (6.4 kg) Coil 56 lb (25.4 kg) Master Carton	25 lb (11.3 kg) Steel Spool	10 lb (4.5 kg) Plastic Spool	50 lb (22.7 kg) Coil	500 lb (227 kg) Speed-Feed [®] Drum
0.045 (1.1)	ED011277	ED031120	ED037254	ED011278 ED011280	ED037695
1/16 (1.6)		ED031121			
5/64 (2.0)		ED031122			
7/64 (2.8)					

MECHANICAL PROPERTIES⁽¹⁾

No. of Layers	Rockwell Hardness (R _c)			
	As-Welded	Work-Hardened	180°C (350°F) Interpass Temp	Flame-Hardened / Water Quenched
1	50 - 59	53 - 62	50 - 55	—
2	50 - 60	56 - 62	55 - 59	52 - 54

DEPOSIT COMPOSITION⁽¹⁾

	%C	%Mn	%Si	%Al	%Cr	%Mo	%S	%P
0.045 in & 1/16 in	0.45	1.3	0.53	1.4	5.3	0.80	0.004	0.010
5/64 in & 7/64 in	0.45	1.4	0.60	1.4	5.3	0.80	0.004	0.010

TYPICAL OPERATING PROCEDURES

Diameter, Polarity ESO - in (mm)	Wire Feed Speed m/min (in/min)	Voltage (Volts)	Approx. Current (Amps)	Deposition Rate kg/hr (lb/hr)
0.045 in (1.1 mm), DC+ 1 3/4 (45)	5.1 (200)	25	85	1.6 (3.6)
	8.9 (350)	28	125	3.0 (6.6)
	12.7 (500)	31	165	4.3 (9.4)
1/16 in (1.6 mm), DC+ 1 3/4 (45)	3.8 (150)	26	125	2.2 (4.8)
	6.4 (250)	29	195	3.8 (8.4)
	8.9 (350)	32	245	5.5 (12.1)
5/64 in (2.0 mm), DC+ 1 3/4 (45)	3.2 (125)	24	190	3.2 (7.0)
	5.1 (200)	27	295	5.0 (11.0)
	6.4 (250)	30	330	6.2 (13.7)
7/64 in (2.8 mm), DC+ 2 1/2 (64)	2.3 (90)	25	280	3.8 (8.4)
	3.2 (125)	27	350	5.2 (11.5)
	4.4 (175)	30	420	7.3 (16.0)

⁽¹⁾ Composition and properties depend upon dilution. Single layer deposit properties depend upon base metal and/or build-up material.

NOTE: Area to be overlaid should be clean and free of rust, oil, etc. Any previous hardfacing deposit that has been embrittled by severe work hardening should be removed. Cracks and other irregularities should be properly repaired.

Cold parts should be warmed to at least 250°C (750°F). Higher preheat of 150 - 260°C (300 - 500°F) may be necessary on thick parts or heavy sections. Interpass temperature between 150°C (300°F) and 200°C (400°F) do not affect the hardness of Lincore[®] 55 significantly.

<p>IMPORTANT: SPECIAL VENTILATION AND/OR EXHAUST REQUIRED</p> <p>Fumes from the normal use of some welding products can contain significant quantities of components - such as chromium and manganese - which can lower the 5.0 mg/m³ maximum exposure guideline for general welding fume.</p> <p>BEFORE USE, READ AND UNDERSTAND THE SAFETY DATA SHEET (SDS) FOR THIS PRODUCT AND SPECIFIC INFORMATION PRINTED ON THE PRODUCT CONTAINER.</p>
--

LINCORE® T & D

Metal-to-Metal

KEY FEATURES

- Delivers a deposit similar to H12 tool steel
- For build-up of tool steel dies and edges, or applying wear resistance surface on carbon or low alloy steels
- To be used on carbon steel, low alloy steel or tool steel

TYPICAL APPLICATIONS

- Punch dies
- Shear blades

WELDING POSITIONS

Flat & Horizontal

DIAMETERS / PACKAGING

Diameter in (mm)	25 lb (11.3 kg) Steel Spool	500 lb (227 kg) Accu-Trak® Drum
1/16 (1.6)	ED031134	ED037911

MECHANICAL PROPERTIES⁽¹⁾

As-Welded	Rockwell Hardness (R _c)	
	Tempered at 540°C (1000°F)	
48 - 55	55 - 65	

DEPOSIT COMPOSITION⁽¹⁾

	%C	%Mn	%Si	%Al	%Cr	%Mo	%W
6 Layers Open Arc	0.65	1.5	0.8	1.8	7.0	1.4	1.6
6 Layers w/ 802 Flux	0.50	1.9	1.0	1.0	7.0	1.4	1.6

TYPICAL OPERATING PROCEDURES

Diameter, Polarity ESO - in (mm)	Wire Feed Speed m/min (in/min)	Voltage (Volts)	Approx. Current (Amps)	Deposition Rate kg/hr (lb/hr)
1/16 in (1.6 mm), DC+ 1 1/4 [32]	3.8 (150)	22	170	2.4 (5.4)
	5.1 (200)	23	210	3.6 (7.9)
	6.4 (250)	24	250	4.1 (8.9)
	7.6 (300)	25	270	4.9 (10.8)
	8.9 (350)	26	300	5.4 (12.0)

⁽¹⁾ Composition and properties depend upon dilution. Single layer deposit properties depend upon base metal and/or build-up material.

NOTE: Minimum preheat and interpass temperatures of 315°C (600°F) are essential for crack-free welding on mild steel or low alloy steel. For crack-free welding on tool steel parts, preheat of 538°C (1000°F) or higher may be necessary. After welding, very slow cooling to 121°C (250°F) is usually required. This can be followed by post-weld heat treating at 538° - 593°C (1000° - 1100°F) to develop maximum hardness.

IMPORTANT: SPECIAL VENTILATION AND/OR EXHAUST REQUIRED

Fumes from the normal use of some welding products can contain significant quantities of components - such as chromium and manganese - which can lower the 5.0 mg/m³ maximum exposure guideline for general welding fume. BEFORE USE, READ AND UNDERSTAND THE SAFETY DATA SHEET (SDS) FOR THIS PRODUCT AND SPECIFIC INFORMATION PRINTED ON THE PRODUCT CONTAINER.

LINCORE® M

Severe Impact

KEY FEATURES

- Deposit resists severe impact as well as moderate abrasion
- Produces an austenitic manganese deposit that work-hardens
- Recommended for build-up and repair of Hadfield-type austenitic manganese materials as well as carbon and low alloy steels
- Unlimited layers with proper preheat and interpass temperatures and procedures

TYPICAL APPLICATIONS

- Hammers
- Dredge parts
- Crushers
- Breaker bars
- Buckets

WELDING PROCESSES

Flat

DIAMETERS / PACKAGING

Diameter in (mm)	25 lb [11.3 kg] Steel Spool	50 lb [22.7 kg] Coil	125 lb [56.7 kg] Speed-Feed® Drum	600 lb [272 kg] Speed-Feed® Drum
0.045 [1.1]	ED031128			
1/16 [1.6]	ED031129			
5/64 [2.0]	ED031130	ED011160		
7/64 [2.8]		ED011164	ED011163	ED011162

MECHANICAL PROPERTIES⁽¹⁾

As-Welded	Rockwell Hardness (R _c)	
	Work Hardened	
18 - 28	30 - 48	

DEPOSIT COMPOSITION⁽¹⁾

	%C	%Mn	%Si	%Cr	%Ni
Open Arc	0.60	13.0	0.4	4.9	0.5

TYPICAL OPERATING PROCEDURES

Diameter, Polarity ESO - in (mm)	Wire Feed Speed m/min (in/min)	Voltage (Volts)	Approx. Current (Amps)	Deposition Rate kg/hr (lb/hr)
0.045 in [1.1 mm], DC+ 1 [25]	5.1 [200]	22	80	1.5 [3.3]
	8.9 [350]	24	145	2.7 [6.0]
	12.7 [500]	26	185	4.4 [9.6]
1/16 in [1.6 mm], DC+ 1 1/8 [30]	3.8 [150]	23	130	2.2 [4.9]
	6.4 [250]	25	200	3.9 [8.6]
	8.9 [350]	27	250	5.6 [12.4]
5/64 in [2.0 mm], DC+ 1 1/4 [32]	3.2 [125]	24	240	2.9 [6.4]
	4.4 [175]	27	300	4.2 [9.3]
	6.4 [250]	29	360	6.2 [13.6]
7/64 in [2.8 mm], DC+ 1 3/4 [45]	1.9 [75]	25	240	3.5 [7.8]
	3.2 [125]	27	360	6.2 [13.6]
	3.8 [150]	28	395	7.5 [16.6]
7/64 in [2.8 mm], DC+ 2 1/2 [64]	1.9 [75]	25	240	3.6 [8.0]
	4.4 [175]	30	400	8.8 [19.5]
	5.7 [225]	32	455	11.6 [25.6]

⁽¹⁾ Composition and properties depend upon dilution. Single layer deposit properties depend upon base metal and/or build-up material.

NOTE: As with all austenitic manganese welding products, interpass temperatures should be limited to 260°C [500°F] maximum. A stringer bead, or at most, a slight weave is recommended to limit heat build-up. Excessive heat build-up causes manganese carbide precipitation which damages the toughness of austenitic manganese.

IMPORTANT: SPECIAL VENTILATION AND/OR EXHAUST REQUIRED
Fumes from the normal use of some welding products can contain significant quantities of components - such as chromium and manganese - which can lower the 5.0 mg/m ³ maximum exposure guideline for general welding fume. BEFORE USE, READ AND UNDERSTAND THE SAFETY DATA SHEET (SDS) FOR THIS PRODUCT AND SPECIFIC INFORMATION PRINTED ON THE PRODUCT CONTAINER.

LINCORE® 15CRMN

Severe Impact

KEY FEATURES

- Provides an austenitic manganese deposit which exhibits very good crack resistance
- Work-hardens for overlay or joining austenitic manganese steel to itself or to carbon steel
- Can be used as a build-up layer before capping with abrasion resistant alloys
- Can be used in open arc mode for joining austenitic manganese steel to carbon steel, low alloy steel, austenitic manganese steel, or stainless steel
- Unlimited layers with proper preheat and interpass temperatures and procedures

TYPICAL APPLICATIONS

- Spreader cones
- Crusher hammers
- Austenitic manganese parts

WELDING POSITIONS

Flat & Horizontal

DIAMETERS / PACKAGING

Diameter in (mm)	25 lb (11.3 kg) Steel Spool	33 lb (15 kg) Steel Spool	50 lb (22.7 kg) Coil	125 lb (56.7 kg) Speed-Feed® Drum
1/16 (1.6)				
5/64 (2.0)	ED031126	ED037492	ED022060	
7/64 (2.8)			ED022061	ED022068

MECHANICAL PROPERTIES⁽¹⁾

	Rockwell Hardness (R _c)	
	As-Welded	Work-Hardened
	18 - 22	40-50

DEPOSIT COMPOSITION⁽¹⁾

	%C	%Mn	%Si	%Cr
6 Layers Open Arc	0.4	15.0	0.25	16.0
6 Layers w/ 801 Flux	0.4	15.0	0.6	16.0

TYPICAL OPERATING PROCEDURES

Diameter, Polarity ESO - in (mm)	Wire Feed Speed m/min (in/min)	Voltage (Volts)	Approx. Current (Amps)	Deposition Rate kg/hr (lb/hr)
5/64 in (2.0 mm), DC+ 1 1/4 (32)	3.2 (125)	26	210	3.3 (7.3)
	5.1 (200)	29	280	5.3 (11.7)
	6.4 (250)	30	320	6.8 (15.1)
	8.9 (350)	32	380	9.7 (21.3)
7/64 in (2.8 mm), DC+ 1 3/4 (45)	1.9 (75)	26	250	2.5 (5.5)
	3.2 (125)	28	320	5.1 (11.3)
	3.8 (150)	29	350	6.6 (14.6)
	4.4 (175)	30	380	7.5 (16.4)
7/64 in (2.8 mm), DC+ 2 1/2 (64)	3.8 (150)	30	320	6.7 (14.9)
	5.1 (200)	33	390	8.7 (19.2)
	5.7 (225)	34	410	9.8 (21.7)
	6.4 (250)	35	425	11.4 (25.1)

⁽¹⁾ Composition and properties depend upon dilution. Single layer deposit properties depend upon base metal and/or build-up material.

NOTE: As with all austenitic manganese welding products, interpass temperatures should be limited to 260°C (500°F) maximum. A stringer bead, or at most, a slight weave is recommended to limit heat build-up. Excessive heat build-up causes manganese carbide precipitation which damages the toughness of austenitic manganese.

IMPORTANT: SPECIAL VENTILATION AND/OR EXHAUST REQUIRED

Fumes from the normal use of some welding products can contain significant quantities of components - such as chromium and manganese - which can lower the 5.0 mg/m³ maximum exposure guideline for general welding fume. BEFORE USE, READ AND UNDERSTAND THE SAFETY DATA SHEET (SDS) FOR THIS PRODUCT AND SPECIFIC INFORMATION PRINTED ON THE PRODUCT CONTAINER.

LINCORE® FROG MANG®

Severe Impact

KEY FEATURES

- Designed for repair of manganese frogs and manganese crossing diamonds in the railroad industry
- High alloy austenitic manganese deposit
- Unlimited layers with proper preheat and interpass temperatures and procedures

TYPICAL APPLICATIONS

- Manganese crossing diamonds
- Manganese railroad frogs

WELDING POSITIONS

Flat & Horizontal

DIAMETERS / PACKAGING

Diameter in (mm)	9 lb (4 kg) Plastic Spool 36 lb (16.3 kg) Master Carton	25 lb (11.3 kg) Steel Spool
1/16 (1.6)	ED034485	ED026106
5/64 (2.0)		ED026105

MECHANICAL PROPERTIES⁽¹⁾

Rockwell Hardness (R _c)	
As-Welded	Work-Hardened
20 - 30	40 - 50

DEPOSIT COMPOSITION⁽¹⁾

	%C	%Mn	%Si	%Cr
6 Layers	<2	<30	<1	<10

TYPICAL OPERATING PROCEDURES

Diameter, Polarity ESO - in (mm)	Wire Feed Speed m/min (in/min)	Voltage (Volts)	Approx. Current (Amps)	Deposition Rate kg/hr (lb/hr)
1/16 in (1.6 mm), DC+ 1 (25)	5.1 (200)	27	220	3.0 (6.7)
	6.4 (250)	29	250	4.0 (8.7)
	8.3 (325)	32	300	5.3 (11.6)
5/64 in (2.0 mm), DC+ 1 1/4 (32)	3.8 (150)	27	240	3.4 (7.4)
	5.1 (200)	29	290	4.9 (10.7)
	6.4 (250)	31	340	6.4 (14.0)

⁽¹⁾ Composition and properties depend upon dilution. Single layer deposit properties depend upon base metal and/or build-up material.

NOTE: Remove all damaged and foreign material by the air-carbon arc gouging process and grinding. Make sure all defective metal is removed. In the event hairline cracks remain at flangeway depth, use a 1/8 in diameter E308 stainless product, such as Blue Max® or Red Baron® 308L AC-DC to tie up these cracks and avoid hot cracking during the buildup process. Use only light amounts and do not build-up with E308 stainless. It is for use in emergency situations where no other alternative is available to repair flangeway cracks. As with all austenitic manganese welding products, interpass temperatures should be limited to 260°C (500°F) maximum. A stringer bead, or at most, a slight weave is recommended to limit heat build-up. Excessive heat build-up causes manganese carbide precipitation which damages the toughness of austenitic manganese.

<p>IMPORTANT: SPECIAL VENTILATION AND/OR EXHAUST REQUIRED</p> <p>Fumes from the normal use of some welding products can contain significant quantities of components - such as chromium and manganese - which can lower the 5.0 mg/m³ maximum exposure guideline for general welding fume.</p> <p>BEFORE USE, READ AND UNDERSTAND THE SAFETY DATA SHEET (SDS) FOR THIS PRODUCT AND SPECIFIC INFORMATION PRINTED ON THE PRODUCT CONTAINER.</p>
--

LINCORE[®] SUPER RAIL[™]

Severe Impact

KEY FEATURES

- Reduce carbon steel repairs by 50%
- Consistent wire feeding with next generation lubrication
- Low material distortion on impact
- Work hardens faster without cracking
- Remove slag easily with hand tools

TYPICAL APPLICATIONS

- Rail Ends/Points
- Rail Crossing Points

WELDING POSITIONS

Flat and Horizontal

DIAMETERS / PACKAGING

Diameters in (mm)	36 lb. (16.32kg) Carton	25 lb (11.35 kg) Spool
1/16 (1.6)	ED035353	ED035354
5/64 (2.0)	ED034800	ED034801

DEPOSIT COMPOSITION⁽¹⁾

	%C	%Mn	%Si	%Cr	%Mo	%Ni	%Al
4 Layers	<1	<5	<2	<5	<1	<3	<3

TYPICAL OPERATING PROCEDURES

Diameter, Polarity Shielding Gas ESO - in (mm)	Wire Feed Speed m/min (in/min)	Voltage (Volts)	Approx. Current (amps)	Deposition Rate kg/hr (lb/hr)
5/64 in (2.0 mm), DC+ 1 1/2 (37)	3.2 (125)	24	218	7.0 (3.2)
	5.1 (200)	27	282	11.1 (5.0)
	6.4 (250)	30	327	13.9 (6.3)
1/16 in (1.6 mm), DC+ 1 (25)	5.1 (200)	25	220	3.0 (6.7)
	6.4 (250)	27	250	4.0 (8.7)
	8.3 (325)	29	300	5.3 (11.6)

⁽¹⁾ Composition and properties depend upon dilution. Single layer deposit properties depend upon base metal and/or build-up material.

IMPORTANT: SPECIAL VENTILATION AND/OR EXHAUST REQUIRED

Fumes from the normal use of some welding products can contain significant quantities of components - such as chromium and manganese - which can lower the 5.0 mg/m³ maximum exposure guideline for general welding fume. BEFORE USE, READ AND UNDERSTAND THE SAFETY DATA SHEET (SDS) FOR THIS PRODUCT AND SPECIFIC INFORMATION PRINTED ON THE PRODUCT CONTAINER.

LINCORE® 50

Abrasion and Impact

KEY FEATURES

- Delivers an abrasion resistant deposit, even under conditions of moderate impact
- Larger wire diameter sizes may be used for the submerged arc process
- Can be used on low carbon, medium carbon, low alloy, manganese and stainless steels
- Limited to 4 layers

TYPICAL APPLICATIONS

- Crusher rolls
- Dredge cutter teeth
- Ore chute baffles
- Muller plows and tires
- Coal mining cutting teeth

WELDING POSITIONS

Flat & Horizontal

DIAMETERS / PACKAGING

Diameter in (mm)	25 lb (11.3 kg) Steel Spool	10 lb (4.5 kg) Plastic Spool	50 lb (22.7 kg) Coil	125 lb (56.7 kg) Speed-Feed® Drum
0.045 (1.1)	ED031123	ED037270		
1/16 (1.6)	ED031124	ED037261	ED020829	
5/64 (2.0)	ED031125		ED017825	
7/64 (2.8)			ED011275	ED011274

MECHANICAL PROPERTIES⁽¹⁾

	Rockwell Hardness (R _c)		
	1 Layer	2 Layers	3 Layers
On Mild Steel	34-37	44-48	48-52
On 0.50% Carbon Steel	41-43	47-50	50-53
On Austenitic Mn Steel	-	43-45	48-50
with 801 Flux	38-43	47-52	48-56

DEPOSIT COMPOSITION⁽¹⁾

	%C	%Mn	%Si	%Al	%Cr	%Mo
Open Arc						
0.045 in & 1/16 in	2.4	1.3	1.0	0.6	11.4	-
5/64 in & 7/64 in	2.0	0.9	1.0	0.6	9.2	0.5
Submerged Arc						
5/64 in & 7/64 in						
w/ 801 Flux	2.5	1.1	1.3	0.4	10.1	0.5
w/ 860 Flux	2.5	2.0	1.7	0.2	11.0	0.5

TYPICAL OPERATING PROCEDURES

Diameter, Polarity ESO - in (mm)	Wire Feed Speed m/min (in/min)	Voltage (Volts)	Approx. Current (Amps)	Deposition Rate kg/hr (lb/hr)
0.045 in (1.1mm), DC+ 1 [25]	5.1 (200)	19-21	120	1.9 (4.2)
	10.2 (400)	23-25	190	3.9 (8.5)
	15.2 (600)	27-29	250	5.8 (12.8)
1/16 in (1.6 mm), DC+ 1 [25]	3.8 (150)	22-24	175	2.7 (5.9)
	8.4 (350)	29-31	325	6.2 (13.6)
	11.4 (450)	32-34	365	7.9 (17.5)
5/64 in (2.0 mm), DC+ 1 1/4 [32]	3.2 (125)	27	210	3.4 (7.4)
	5.1 (200)	31	325	5.4 (11.9)
	6.4 (250)	33	380	6.8 (14.9)
7/64 in (2.8 mm), DC+ 1 1/4 [32]	2.0 (80)	26	315	3.9 (8.6)
	2.5 (100)	27	375	4.9 (10.7)
	3.3 (130)	29	450	6.4 (14.0)
7/64 in (2.8 mm), DC+ 2 1/2 [64]	2.5 (100)	27	315	4.9 (10.7)
	3.3 (130)	29	370	6.4 (14.0)
	4.4 (175)	31	450	8.6 (19.0)
With Recommended Neutral Fluxes				
7/64 in (2.8 mm), DC+ 1 1/4 [32]	2.5 (100)	29	400	5.2 (11.4)
	3.0 (120)	30	450	6.2 (13.7)
	4.4 (175)	33	540	9.1 (20.0)

⁽¹⁾ Composition and properties depend upon dilution. Single layer deposit properties depend upon base metal and/or build-up material.

IMPORTANT: SPECIAL VENTILATION AND/OR EXHAUST REQUIRED

Fumes from the normal use of some welding products can contain significant quantities of components - such as chromium and manganese - which can lower the 5.0 mg/m³ maximum exposure guideline for general welding fume. BEFORE USE, READ AND UNDERSTAND THE SAFETY DATA SHEET (SDS) FOR THIS PRODUCT AND SPECIFIC INFORMATION PRINTED ON THE PRODUCT CONTAINER.

LINCORE® 60-0

Severe Abrasion

KEY FEATURES

- Deposits feature higher alloy levels than to resist both abrasion and moderate impact
- Can be used at temperatures up to 704°C (1300°F)
- To be used on carbon, low alloy, manganese, stainless steels and cast iron
- Deposit is limited to two layers

TYPICAL APPLICATIONS

- Bucket lips
- Crusher hammers
- Ore chutes
- Dozer blades
- Ripper teeth

WELDING POSITIONS

Flat & Horizontal

DIAMETERS / PACKAGING

Diameter in (mm)	25 lb (11.3 kg) Steel Spool	10 lb (4.5 kg) Plastic Spool	50 lb (22.7 kg) Coil	500 lb (227 kg) Speed-Feed® Drum
0.045 (1.1)	ED031131	ED037262		
1/16 (1.6)	ED031132	ED037263		
5/64 (2.0)	ED031133		ED019887	ED037493
7/64 (2.8)			ED019888	

MECHANICAL PROPERTIES⁽¹⁾

Rockwell Hardness (R _c)	
55-60	

DEPOSIT COMPOSITION⁽¹⁾

	%C	%Mn	%Si	%Al	%Cr
2 Layers Open Arc	3.7 - 4.3	0.8 - 0.9	0.8 - 1.0	0.3 - 0.4	20.0 - 21.3
2 Layers w/ 802 Flux	3.6 - 4.0	1.0 - 1.1	1.0 - 1.1	0.2 - 0.3	17.4 - 18.5

TYPICAL OPERATING PROCEDURES

Diameter, Polarity ESD - in (mm)	Wire Feed Speed m/min (in/min)	Voltage (Volts)	Approx. Current (Amps)	Deposition Rate kg/hr (lb/hr)
0.045 in (1.1mm), DC+ 1 (25)	5.1 (200)	21	125	1.9 (4.1)
	10.2 (400)	25	185	3.7 (8.2)
	12.7 (500)	27	210	4.7 (10.3)
1/16 in (1.6 mm), DC+ 7/8 (22)	5.1 (200)	28	240	3.4 (7.6)
	7.6 (300)	31	300	5.1 (11.2)
	11.4 (450)	33	350	7.5 (16.6)
5/64 in (2.0 mm), DC+ 1 1/4 (32)	3.2 (125)	26	250	3.4 (7.4)
	5.1 (200)	30	350	5.4 (12.0)
	6.4 (250)	32	400	6.9 (15.1)
7/64 in (2.8 mm), DC+ 1 1/8 (30)	1.9 (75)	27	250	3.4 (7.4)
	3.2 (125)	30	340	5.4 (11.9)
	4.4 (175)	32	420	7.5 (16.5)
With Recommended Neutral Fluxes				
7/64 in (2.8 mm), DC+ 1 1/8 (30)	2.5 (100)	30	295	4.4 (9.6)
	3.2 (125)	32	340	5.4 (11.9)
	4.4 (175)	34	420	7.5 (16.5)

⁽¹⁾ Composition and properties depend upon dilution. Single layer deposit properties depend upon base metal and/or build-up material.

NOTE: Deposit thickness limit is two layers unless high travel speed is used to obtain very closely spaced check cracks. Many layers can be used with high travel speed and small bead sizes to ensure close-spaced check cracks. Lincore® 60-0 deposit cross cracks (commonly called cross-checking) on cooling. This is desirable, since cross-cracking of the deposit relieves cooling stresses and prevents spalling.

<p>IMPORTANT: SPECIAL VENTILATION AND/OR EXHAUST REQUIRED</p> <p>Fumes from the normal use of some welding products can contain significant quantities of components - such as chromium and manganese - which can lower the 5.0 mg/m³ maximum exposure guideline for general welding fume.</p> <p>BEFORE USE, READ AND UNDERSTAND THE SAFETY DATA SHEET (SDS) FOR THIS PRODUCT AND SPECIFIC INFORMATION PRINTED ON THE PRODUCT CONTAINER.</p>
--

LINCORE® ULTRA K

Severe Abrasion

KEY FEATURES

- Chrome carbide deposit provides economical abrasion resistance
- Superior manufacturing process eliminates seam issues and empty tube
- Consistent deposit chemistry and hardness at recommended procedures
- Low spatter and virtually no slag clean up required
- Limited to 2 layers max

TYPICAL APPLICATIONS

- Wearplate
- Crusher rolls
- Ore Chutes
- Screw Augers

WELDING POSITIONS

Flat & Horizontal Only

DIAMETERS / PACKAGING

Diameter in (mm)	600 lb (272 kg) Speed-Feed® Drum
1/8 (3.2)	ED034802
7/64 (2.8)	ED037341

MECHANICAL PROPERTIES⁽¹⁾

Rockwell Hardness (R _c)
56-62

DEPOSIT COMPOSITION⁽¹⁾

%Fe	%C	%Cr	%Mn	%Si	%Al
Balance	<10	<35	<5	<2	<1

TYPICAL OPERATING PROCEDURES

Diameter, Polarity ESO - in (mm)	Wire Feed Speed m/min (ipm)	Voltage (Volts)	Approx. Current (Amps)
1/8 in (3.2 mm), DC+ 1 1/2 (38) FCAW-S	4.8 (190)	29	-500

⁽¹⁾ Composition and properties depend upon dilution. Single layer deposit properties depend upon base metal and/or build-up material.

<p>IMPORTANT: SPECIAL VENTILATION AND/OR EXHAUST REQUIRED</p> <p>Fumes from the normal use of some welding products can contain significant quantities of components - such as chromium and manganese - which can lower the 5.0 mg/m³ maximum exposure guideline for general welding fume. BEFORE USE, READ AND UNDERSTAND THE SAFETY DATA SHEET (SDS) FOR THIS PRODUCT AND SPECIFIC INFORMATION PRINTED ON THE PRODUCT CONTAINER.</p>

LINCORE® 65-0

Severe Abrasion

KEY FEATURES

- Deposits include higher carbon and chrome levels than Lincore® 60-0
- Recommended for use on wear plate, coal pulverizer rolls, earth engaging tools, and on slurry pipe and elbows
- To be used on carbon, low alloy, manganese, stainless steels and cast iron
- Limited to four layers

TYPICAL APPLICATIONS

- Screw augers
- Ore chutes and wearplates
- Crusher rolls
- Ripper teeth

WELDING POSITIONS

Flat & Horizontal

DIAMETERS / PACKAGING

Diameter in (mm)	50 lb (22.7 kg) Coil	500 lb (227 kg) Speed-Feed® Drum
1/8 (3.2)		ED026082
7/64 (2.8)	ED026077	ED026083

MECHANICAL PROPERTIES⁽¹⁾

	Rockwell Hardness (R _c)		
	1 Layer	2 Layers	4 Layers
	57	60	64

DEPOSIT COMPOSITION⁽¹⁾

	%C	%Mn	%Si	%Cr
1 Layer	3.7	1.3	0.7	19.9
2 Layers	4.9	1.6	1.0	26.2
4 Layers	5.7	1.8	1.1	30.8

TYPICAL OPERATING PROCEDURES

Diameter, Polarity ESO - in (mm)	Wire Feed Speed m/min (in/min)	Voltage (Volts)	Approx. Current (Amps)	Deposition Rate kg/hr (lb/hr)
7/64 in (2.8 mm), DC+ 1 1/8 (30)	2.5 (100)	28	280	4.4 (9.6)
	5.1 (200)	31	420	8.9 (19.7)
	7.6 (300)	33	500	13.5 (29.8)
1/8 in (3.2 mm), DC+ 1 1/2 (37)	2.5 (100)	27	375	6.4 (14.0)
	4.4 (175)	29	500	11.4 (25.1)
	6.7 (265)	31	625	16.7 (36.7)

4 layers of Lincore 65-0	
Condition	Rockwell Hardness C
As-Welded	63
Aged at 1200°F (650°C) for 2 hours	56
Aged at 1400°F (760°C) for 2 hours	54

⁽¹⁾ Composition and properties depend upon dilution. Single layer deposit properties depend upon base metal and/or build-up material.

NOTE: Postweld heat treatment up to 1400°F (760°C) will not affect abrasion resistance very significantly, but will affect hardness to some extent. Typical results are shown above:

<p>IMPORTANT: SPECIAL VENTILATION AND/OR EXHAUST REQUIRED</p> <p>Fumes from the normal use of some welding products can contain significant quantities of components - such as chromium and manganese - which can lower the 5.0 mg/m³ maximum exposure guideline for general welding fume.</p> <p>BEFORE USE, READ AND UNDERSTAND THE SAFETY DATA SHEET (SDS) FOR THIS PRODUCT AND SPECIFIC INFORMATION PRINTED ON THE PRODUCT CONTAINER.</p>
--

LINCORE® 70-0

Severe Abrasion

KEY FEATURES

- Exceptional wear resistance with deposits that last approximately 2-3 times longer than most chrome carbide and complex carbide alloys, especially in wet abrasion applications
- Maintains high hardness after exposure to elevated temperatures up to 1000°F (538°C)
- Best suited for carbon and low alloy steels. Not compatible for austenitic stainless or austenitic manganese steels. Limited to a maximum of two layers
- Great for high value applications where downtime is costly or replacement parts are expensive

WELDING POSITIONS

Flat & Horizontal Only

TYPICAL APPLICATIONS

- Wearplate
- Crusher Rolls
- Ore Chutes
- Screw Augers

DIAMETERS / PACKAGING

Diameter in (mm)	10 lb (4.5 kg) Spool	33 lb (15 kg) Spool	50 lb (22.7 kg) Coil
0.045 (1.1)	ED037264	ED037265	-
1/16 (1.6)	ED037266	ED037267	-
5/64 (2.0)	-	ED037268	-
7/64 (2.8)	-	-	ED037269

MECHANICAL PROPERTIES⁽¹⁾

Rockwell Hardness [R _c]	Wear Resistance (ASTM G65-04 Procedure A)
67-70	0.13 g mass loss

DEPOSIT COMPOSITION⁽¹⁾

%Fe	%C	%Cr%	%B	%Nb	%Al	%Mn	%Si
Balance	<3	<18	<6	<10	<5	<2	<2

⁽¹⁾ Composition and properties depend on dilution. Single layer deposit properties depend upon base metal and/or build-up material.

TYPICAL OPERATING PROCEDURES

Diameter, Polarity ESO – in (mm)	Current (Amps)	Voltage (Volts)	Wire Feed Speed m/min (ipm)	Deposition Rate lb/hr
0.045 in (1.1 mm), DC+ 3/4-1 (20) FCAW-S	~ 135	24	7.0 (275)	6.5
1/16 in (1.6 mm), DC+ 3/4-1 (20) FCAW-S	~ 220	24	7.0 (275)	10.5
5/64 in (2.0 mm) DC+ 3/4-1 (20) FCAW-S	~ 300	25	7.0 (275)	–
7/64 in (2.8 mm) DC+ 3/4-1.75 (40) FCAW-S	~ 450	26	5.7 (225)	–

IMPORTANT: SPECIAL VENTILATION AND/OR EXHAUST REQUIRED

Fumes from the normal use of some welding products can contain significant quantities of components - such as chromium and manganese - which can lower the 5.0 mg/m³ maximum exposure guideline for general welding fume. BEFORE USE, READ AND UNDERSTAND THE SAFETY DATA SHEET (SDS) FOR THIS PRODUCT AND SPECIFIC INFORMATION PRINTED ON THE PRODUCT CONTAINER.

LINCORE® TICORE

Severe Abrasion

KEY FEATURES

- Better wear characteristics than martensitic only deposit
- Low spatter and easy slag cleanup
- Deposits do not check crack
- Limited to 4 layers max

TYPICAL APPLICATIONS

- Wearplate
- Crusher rolls
- Ore Chutes

WELDING POSITIONS

Flat & Horizontal Only

DIAMETERS / PACKAGING

Diameter in (mm)	25 lb (11.3 kg) Coil
5/64 (2.0)	ED035628

MECHANICAL PROPERTIES⁽¹⁾

Rockwell Hardness (R _c)
57-64

DEPOSIT COMPOSITION⁽¹⁾

%Fe	%C	%Cr	%V	%Mo	%Mn	%Si	%Ti	%Al
Balance	<5	<15	<2	<5	<5	<5	<20	<1

TYPICAL OPERATING PROCEDURES

Diameter, Polarity ESO - in (mm)	Wire Feed Speed m/min (ipm)	Voltage (Volts)	Approx. Current (Amps)
5/64 in (2.0 mm), DC+ 1 1/2 (38) FCAW-S	5.1 (200)	27	~260

⁽¹⁾ Composition and properties depend upon dilution. Single layer deposit properties depend upon base metal and/or build-up material.

IMPORTANT: SPECIAL VENTILATION AND/OR EXHAUST REQUIRED

Fumes from the normal use of some welding products can contain significant quantities of components - such as chromium and manganese - which can lower the 5.0 mg/m³ maximum exposure guideline for general welding fume. BEFORE USE, READ AND UNDERSTAND THE SAFETY DATA SHEET (SDS) FOR THIS PRODUCT AND SPECIFIC INFORMATION PRINTED ON THE PRODUCT CONTAINER.

LINCORE® 65 PLUS

Severe Abrasion

KEY FEATURES

- Can be used for overlays on castings
- Austenitic matrix with uniformly distributed chromium carbides
- One to four layers with proper preheat and interpass temperatures
- Improved wear resistance compared to conventional chromium carbide products

TYPICAL APPLICATIONS

- Cement
- Coal Pulverizing
- Cladding
- Wear plates
- Sugar mills
- Blades
- Dredge cutter teeth

WELDING POSITIONS

Flat & Horizontal

DIAMETERS / PACKAGING

Diameter in (mm)	50 lb (22.7kg) Coil	600 lb (272 kg) drum
1/8 (3.2)	ED037675	ED037674
7/64 (2.8)	ED037673	ED037672

MECHANICAL PROPERTIES⁽¹⁾

Rockwell Hardness (R _c)	
58-65	

DEPOSIT COMPOSITION⁽¹⁾

	%C	%Cr	%Mn	%Si	%B	%Mo	%Ti	%ZR
4 layers	4.6	27	1.5	0.6	0.4	0.9	0.3	0.3

TYPICAL OPERATING PROCEDURES

Diameter, Polarity ESO - in (mm)	Wire Feed Speed m/min (ipm)	Voltage (Volts)	Approx. Current (Amps)	Deposition rate kg/hr (lb/hr)
7/64 in (2.8 mm), DC+ 1-1/8 (30)	2.5 (100)	28	280	4.4 (9.6)
	5.1 (200)	31	420	8.9 (19.7)
	7.6 (300)	33	500	13.5 (29.8)
1/8 in (3.2 mm), DC+ 1 1/2 (38) FCAW-S	2.5 (100)	27	375	6.4 (14.0)
	4.4 (175)	29	500	11.4 (25.1)
	6.7 (265)	31	625	16.7 (36.7)

⁽¹⁾ Composition and properties depend upon dilution. Single layer deposit properties depend upon base metal and/or build-up material.

IMPORTANT: SPECIAL VENTILATION AND/OR EXHAUST REQUIRED

Fumes from the normal use of some welding products can contain significant quantities of components - such as chromium and manganese - which can lower the 5.0 mg/m³ maximum exposure guideline for general welding fume. BEFORE USE, READ AND UNDERSTAND THE SAFETY DATA SHEET (SDS) FOR THIS PRODUCT AND SPECIFIC INFORMATION PRINTED ON THE PRODUCT CONTAINER.

LINCOLN® SHS® 9800U

Severe Abrasion

KEY FEATURES

- Exceptional resistance to severe sliding abrasion
- Provides longer lasting wear life than most chrome carbide and complex carbide alloys
- Improved impact resistance results from complex borocarbide phases surrounded by ductile phases that form during welding
- Limited to 2 layers max

TYPICAL APPLICATIONS

- Wearplate
- ID Clad Pipe
- Slurry Transport
- Crusher Rolls
- Ore Chutes
- Screw Augers

DIAMETERS / PACKAGING

Diameter in (mm)	33 lb (15 kg) Spool PLW	50 lb (22.7 kg) Fiber Spool PLW	55 lb (25 kg) Coil	280 lb (127 kg) Drum	400 lb (181 kg) Speed Feed Drum	500 lb (227 kg) Speed Feed Drum	600 lb (272 kg) Speed Feed Drum
0.045 (1.1)	ED035650						
1/16 (1.6)	ED035648	ED035858			ED035859		
3/32 (2.4)			ED035646			ED035860	
7/64 (2.8)			ED035645	ED035973		ED035924	ED037899

MECHANICAL PROPERTIES⁽¹⁾

Rockwell Hardness [R _c]	Wear Resistance
68-71	ASTM G65-04 Procedure A, 0.12 g mass loss

DEPOSIT COMPOSITION⁽¹⁾

%Fe	%C	%Cr	%B	%Mo	%Nb	%Mn	%Si
Balance	<2	<21	<7	<6	<6	<2	<2

TYPICAL OPERATING PROCEDURES

Diameter, Polarity ESO - in (mm)	Current (Amps)	Voltage (Volts)	Wire Feed Speed m/min (ipm)	Shielding Gas	Flow Rate (cfh)
0.045 in (1.1mm), DC+ 1/2 - 3/4 (15) GMAW-C 3/4 - 1 (20) FCAW-S	-135	24	7.0 (275)	75 Ar - 25 CO ₂	35 - 45
1/16 in (1.6mm), DC+ 1/2 - 3/4 (15) GMAW-C 3/4 - 1 (20) FCAW-S	-220	24	7.0 (275)	75 Ar - 25 CO ₂	45 - 60
3/32 in (2.4mm), DC+ 3/4 - 1 (20) GMAW-C 3/4 - 1.25 (25) FCAW-S	-375	25	7.0 (275)	75 Ar - 25 CO ₂	55 - 70
7/64 in (2.8mm), DC+ 3/4 - 1 (20) GMAW-C 1 - 1 3/4 (40) FCAW-S	-450	26	5.7 (225)	75 Ar - 25 CO ₂	60 - 80

⁽¹⁾ Composition and properties depend upon dilution. Single layer deposit properties depend upon base metal and/or build-up material.

IMPORTANT: SPECIAL VENTILATION AND/OR EXHAUST REQUIRED
Fumes from the normal use of some welding products can contain significant quantities of components - such as chromium and manganese - which can lower the 5.0 mg/m ³ maximum exposure guideline for general welding fume. BEFORE USE, READ AND UNDERSTAND THE SAFETY DATA SHEET (SDS) FOR THIS PRODUCT AND SPECIFIC INFORMATION PRINTED ON THE PRODUCT CONTAINER.

LINCOLN® SHS® 9700U

Severe Abrasion

KEY FEATURES

- Lower cost while maintaining near nanoscale (submicron) microstructure
- Provides exceptional wear resistance lasting significantly longer than most chrome carbide and complex carbide alloys
- Maintains high hardness after exposure to elevated temperature
- Limited to 2 layers max

TYPICAL APPLICATIONS

- Wearplate
- Crusher Rolls
- Ore Chutes
- Screw Augers

DIAMETERS / PACKAGING

Diameter in (mm)	33 lb (15 kg) Spool PLW	55 lb (25 kg) Coil	400 lb (181.4 kg) Speed Feed® Drum	500 lb (227 kg) Speed Feed Drum
0.045 (1.1)	ED035658			
1/16 (1.6)	ED037276			
3/32 (2.4)		ED035655	ED037594	ED037616
7/64 (2.8)		ED035654		ED035857

MECHANICAL PROPERTIES⁽¹⁾

Rockwell Hardness (R _c)	Wear Resistance
67-70	ASTM G65-04 Procedure A, 0.13 g mass loss

DEPOSIT COMPOSITION⁽¹⁾

%Fe	%C	%Cr	%B	%Nb	%Al	%Mn	%Si
Balance	<3	<18	<6	<10	<5	<2	<2

TYPICAL OPERATING PROCEDURES

Diameter, Polarity ESO - in (mm)	Current (Amps)	Voltage (Volts)	Wire Feed Speed m/min (ipm)	Shielding Gas	Flow Rate (cfh)
0.045 in (1.1mm), DC+ 1/2 - 3/4 (15) GMAW-C 3/4 - 1 (20) FCAW-S	-135	24	7.0 (275)	75 Ar - 25 CO ₂	35 - 45
1/16 in (1.6mm), DC+ 1/2 - 3/4 (15) GMAW-C 3/4 - 1 (20) FCAW-S	-220	24	7.0 (275)	75 Ar - 25 CO ₂	45 - 60
3/32 in (2.4mm), DC+ 3/4 - 1 (20) GMAW-C 3/4 - 1.25 (25) FCAW-S	-375	25	7.0 (275)	75 Ar - 25 CO ₂	55 - 70
7/64 in (2.8mm), DC+ 3/4 - 1 (20) GMAW-C 1 - 1 3/4 (40) FCAW-S	-450	26	5.7 (225)	75 Ar - 25 CO ₂	60 - 80

⁽¹⁾ Composition and properties depend upon dilution. Single layer deposit properties depend upon base metal and/or build-up material.

<p>IMPORTANT: SPECIAL VENTILATION AND/OR EXHAUST REQUIRED</p> <p>Fumes from the normal use of some welding products can contain significant quantities of components - such as chromium and manganese - which can lower the 5.0 mg/m³ maximum exposure guideline for general welding fume. BEFORE USE, READ AND UNDERSTAND THE SAFETY DATA SHEET (SDS) FOR THIS PRODUCT AND SPECIFIC INFORMATION PRINTED ON THE PRODUCT CONTAINER.</p>

LINCOLN® SHS® 9192U

Severe Abrasion

KEY FEATURES

- Extreme resistance to abrasion
- Maintains high hardness after exposure to high temperatures
- Provides exceptional uniformity of hardness and wear performance across a range of service environments
- Limited to 2 layers max

TYPICAL APPLICATIONS

- Wearplate
- Crusher Rolls
- Ore Chutes
- Screw Augers

DIAMETERS / PACKAGING

Diameter in (mm)	33 lb (15 kg) Spool PLW	50 lb (xx kg) Spool PLW	55 lb (25 kg) Coil	400 lb (181 kg) Speed Feed® Drum	500 lb (226.8 kg) Drum
0.045 (1.1)	ED035663	ED037595	ED035661 ED035660	ED037278	ED037614 ED037615
1/16 (1.6)	ED037277				
3/32 (2.4)					
7/64 (2.8)					

MECHANICAL PROPERTIES⁽¹⁾

Rockwell Hardness [R _c]	Wear Resistance
69-72	ASTM G65-04 Procedure A, 0.10 g mass loss

DEPOSIT COMPOSITION⁽¹⁾

%Fe	%C	%Cr	%W	%B	%Mo	%Nb	%Mn	%Si	%Al
Balance	<5	<20	<10	<5	<10	<10	<5	<2	<5

TYPICAL OPERATING PROCEDURES

Diameter, Polarity ESO - in (mm)	Current (Amps)	Voltage (Volts)	Wire Feed Speed m/min (ipm)	Shielding Gas	Flow Rate (cfh)
0.045 in (1.1mm), DC+ 1/2 - 3/4 (15) GMAW-C 3/4 - 1 (20) FCAW-S	-135	24	7.0 (275)	75 Ar - 25 CO ₂	35 - 45
1/16 in (1.6mm), DC+ 1/2 - 3/4 (15) GMAW-C 3/4 - 1 (20) FCAW-S	-220	24	7.0 (275)	75 Ar - 25 CO ₂	45 - 60
3/32 in (2.4mm), DC+ 3/4 - 1 (20) GMAW-C 3/4 - 1.25 (25) FCAW-S	-375	25	7.0 (275)	75 Ar - 25 CO ₂	55 - 70
7/64 in (2.8mm), DC+ 3/4 - 1 (20) GMAW-C 1 - 1 3/4 (40) FCAW-S	-450	26	5.7 (225)	75 Ar - 25 CO ₂	60 - 80

⁽¹⁾ Composition and properties depend upon dilution. Single layer deposit properties depend upon base metal and/or build-up material.

<p>IMPORTANT: SPECIAL VENTILATION AND/OR EXHAUST REQUIRED</p> <p>Fumes from the normal use of some welding products can contain significant quantities of components - such as chromium and manganese - which can lower the 5.0 mg/m³ maximum exposure guideline for general welding fume. BEFORE USE, READ AND UNDERSTAND THE SAFETY DATA SHEET (SDS) FOR THIS PRODUCT AND SPECIFIC INFORMATION PRINTED ON THE PRODUCT CONTAINER.</p>

LINCOLN® SHS® 9500U

Severe Abrasion

KEY FEATURES

- Minimal cracking when applied to plain carbon and alloy steels
- Lower cost while maintaining near nanoscale (submicron) microstructure
- High resistance to abrasion and galling
- Limited to 2 layers max

TYPICAL APPLICATIONS

- Wearplate
- Crusher Rolls
- Ore Chutes
- Screw Augers

DIAMETERS / PACKAGING

Diameter in (mm)	33 lb (15 kg) Spool PLW
0.045 (1.1)	ED035749
1/16 (1.6)	ED037275

MECHANICAL PROPERTIES⁽¹⁾

Rockwell Hardness [R _c]	Wear Resistance
58-62	ASTM G65-04 Procedure A, 0.22 g mass loss

DEPOSIT COMPOSITION⁽¹⁾

%Fe	%C	%Cr	%B	%Nb	%Mn	%Si
Balance	<3	<10	<6	<9	<5	<2

TYPICAL OPERATING PROCEDURES

Diameter, Polarity ESO - in (mm)	Current (Amps)	Voltage (Volts)	Wire Feed Speed m/min (ipm)	Shielding Gas	Flow Rate (cfh)
0.045 in (1.1mm), DC+ 1/2 - 3/4 (15) GMAW-C 3/4 - 1 (20) FCAW-S	-135	24	7.0 (275)	75 Ar - 25 CO ₂	35 - 45
1/16 in (1.6mm), DC+ 1/2 - 3/4 (15) GMAW-C 3/4 - 1 (20) FCAW-S	-220	24	7.0 (275)	75 Ar - 25 CO ₂	45 - 60

⁽¹⁾ Composition and properties depend upon dilution. Single layer deposit properties depend upon base metal and/or build-up material.

<p>IMPORTANT: SPECIAL VENTILATION AND/OR EXHAUST REQUIRED</p> <p>Fumes from the normal use of some welding products can contain significant quantities of components - such as chromium and manganese - which can lower the 5.0 mg/m³ maximum exposure guideline for general welding fume. BEFORE USE, READ AND UNDERSTAND THE SAFETY DATA SHEET (SDS) FOR THIS PRODUCT AND SPECIFIC INFORMATION PRINTED ON THE PRODUCT CONTAINER.</p>
--

LINCOLNWELD® A-96-S

Hardfacing · Flux

KEY FEATURES

- Modified Type 420 stainless deposit with a carbon content near the high side for as-welded hardness
- Designed to produce a weld deposit with 13% chromium, 0.23% carbon when proper procedures are followed

TYPICAL APPLICATIONS

- Use with Lincolnweld® L-60 mild steel wire for hardfacing

PACKAGING

60 lb (27.2 kg) Plastic Bag

ED031860

DIAMETERS / PACKAGING

Diameter - in (mm)	60 lb (27.2 kg) Plastic Bag
N/A	ED031860

NOTE: Deposit carbon, alloy content and hardness depend upon the ratio of flux melted to wire melted. High voltage promotes high carbon and alloy contents, while low voltage promotes lower carbon and alloy content.

IMPORTANT: SPECIAL VENTILATION AND/OR EXHAUST REQUIRED

Fumes from the normal use of some welding products can contain significant quantities of components - such as chromium and manganese - which can lower the 5.0 mg/m³ maximum exposure guideline for general welding fume. BEFORE USE, READ AND UNDERSTAND THE SAFETY DATA SHEET (SDS) FOR THIS PRODUCT AND SPECIFIC INFORMATION PRINTED ON THE PRODUCT CONTAINER.

LINCOLNWELD® H-535™

Hardfacing · Flux

KEY FEATURES

- Produces a deposit with good abrasion resistance, allows some machinability
- Low carbon martensitic deposit
- Hardness range is 24-45 Rockwell C (R_C), depending upon the actual welding procedure used

TYPICAL APPLICATIONS

- Use with Lincolnweld® L-60 mild steel wire for hardfacing

PACKAGING

50 lb (22.7 kg) Paper Bag

ED027865

DIAMETERS / PACKAGING

Diameter - in (mm)	50 lb (22.7 kg) Paper Bag
N/A	ED027865

NOTE: Deposit carbon, alloy content and hardness depend upon the ratio of flux melted to wire melted. High voltage promotes high carbon and alloy contents, while low voltage promotes lower carbon and alloy content.

IMPORTANT: SPECIAL VENTILATION AND/OR EXHAUST REQUIRED

Fumes from the normal use of some welding products can contain significant quantities of components - such as chromium and manganese - which can lower the 5.0 mg/m³ maximum exposure guideline for general welding fume. BEFORE USE, READ AND UNDERSTAND THE SAFETY DATA SHEET (SDS) FOR THIS PRODUCT AND SPECIFIC INFORMATION PRINTED ON THE PRODUCT CONTAINER.

LINCOLNWELD® H-560™

Hardfacing · EN 760 – S A Z 3

KEY FEATURES

- High alloy flux depositing primary carbides in a martensitic matrix
- Excellent material for severe abrasion applications
- Resistance to abrasion is 50 to 60 times that of plain carbon steel

TYPICAL APPLICATIONS

- Use with Lincolnweld® L-60 mild steel wire for hardfacing

PACKAGING

100 lb (45.4 kg) Paper Bag

ED010345

DIAMETERS / PACKAGING

Diameter in (mm)	60 lb (27.2 kg) Paper Bag
N/A	ED036785

NOTE: Deposit carbon, alloy content and hardness depend upon the ratio of flux melted to wire melted. High voltage promotes high carbon and alloy contents, while low voltage promotes lower carbon and alloy content.

IMPORTANT: SPECIAL VENTILATION AND/OR EXHAUST REQUIRED

Fumes from the normal use of some welding products can contain significant quantities of components - such as chromium and manganese - which can lower the 5.0 mg/m³ maximum exposure guideline for general welding fume. BEFORE USE, READ AND UNDERSTAND THE SAFETY DATA SHEET (SDS) FOR THIS PRODUCT AND SPECIFIC INFORMATION PRINTED ON THE PRODUCT CONTAINER.

LINCOLNWELD® 801®

Neutral Flux · EN 760 – S A FB 1; EN 760 – S A FB 2

KEY FEATURES

- Provides smooth beads and excellent slag removal
- Fast-freezing

TYPICAL APPLICATIONS

- Hardfacing
- Use with Lincore® 20, 30-S, 35-S, 40-S, 42-S, 4130, 8620, 410, 410NiMo, 420 and 96S

PACKAGING

50 lb (22.7 kg) Paper Bag	ED019588
550 lb (249 kg) Drum	ED023403
3000 lb (1361 kg) Bulk Bag	EDS30786

DIAMETERS / PACKAGING

Diameter - in (mm)	50 lb (22.7 kg) Paper Bag	550 lb (249 kg) Drum	3000 lb (1361 kg) Bulk Bag
N/A	ED019588	ED023403	EDS30786

NOTE: Deposit carbon, alloy content and hardness depend upon the ratio of flux melted to wire melted. High voltage promotes high carbon and alloy contents, while low voltage promotes lower carbon and alloy content.

IMPORTANT: SPECIAL VENTILATION AND/OR EXHAUST REQUIRED

Fumes from the normal use of some welding products can contain significant quantities of components - such as chromium and manganese - which can lower the 5.0 mg/m³ maximum exposure guideline for general welding fume. BEFORE USE, READ AND UNDERSTAND THE SAFETY DATA SHEET (SDS) FOR THIS PRODUCT AND SPECIFIC INFORMATION PRINTED ON THE PRODUCT CONTAINER.

LINCOLNWELD® 802®

Neutral Flux · EN 760 – S A CS 1; EN 760 – S A CS 2

KEY FEATURES

- Excellent hot slag removal with wire containing niobium, vanadium or very high chromium levels

TYPICAL APPLICATIONS

- Hardfacing
- Use with Lincore® 102W, 423Cr, 423N, 414N, and 102HC

PACKAGING

50 lb (22.7 kg) Paper Bag	ED032800
450 lb (204 kg) Drum	ED023365
2700 lb (1225 kg) Bulk Bag	EDS30787

DIAMETERS / PACKAGING

Diameter - in (mm)	50 lb (22.7 kg) Paper Bag	450 lb (204 kg) Drum	2700 lb (1225 kg) Bulk Bag
N/A	ED032800	ED023365	EDS30787

NOTE: Deposit carbon, alloy content and hardness depend upon the ratio of flux melted to wire melted. High voltage promotes high carbon and alloy contents, while low voltage promotes lower carbon and alloy content.

IMPORTANT: SPECIAL VENTILATION AND/OR EXHAUST REQUIRED

Fumes from the normal use of some welding products can contain significant quantities of components - such as chromium and manganese - which can lower the 5.0 mg/m³ maximum exposure guideline for general welding fume. BEFORE USE, READ AND UNDERSTAND THE SAFETY DATA SHEET (SDS) FOR THIS PRODUCT AND SPECIFIC INFORMATION PRINTED ON THE PRODUCT CONTAINER.

LINCOLN® GUARDIAN™ HB

Severe Abrasion

KEY FEATURES

- Industry leading casing wear protection
- High tool joint protection in casing
- Superior spalling resistance
- Weldable with or without gas shielding

TYPICAL APPLICATIONS

- Hardbanding

DIAMETERS / PACKAGING

Diameter in (mm)	33 lb (15 kg) Spool
1/16 (1.6)	ED035667

MECHANICAL PROPERTIES⁽¹⁾

Rockwell Hardness [R _c]	Wear Resistance
57-59	ASTM G65-04 Procedure A 0.32 g mass loss

DEPOSIT COMPOSITION⁽¹⁾

%Fe	%C	%Cr	%B	%Mo	%W	%Ti	%Mn	%Si
Balance	<2	<20	<5	<4	<6	<3	<4	<2

TYPICAL OPERATING PROCEDURES

Diameter, Polarity ESO - in (mm)	Current (Amps)	Voltage (Volts)	Wire Feed Speed m/min (ipm)	Shielding Gas	Flow Rate (cfh)
1/16 in (1.6mm), DC+ 1/2 - 3/4 (15) GMAW-C ⁽²⁾ Two layers, - 1 (20) FCAW-S	-220	24	70 (275)	75 Ar - 25 CO ₂	45-60

IMPORTANT: SPECIAL VENTILATION AND/OR EXHAUST REQUIRED

Fumes from the normal use of some welding products can contain significant quantities of components - such as chromium and manganese - which can lower the 5.0 mg/m³ maximum exposure guideline for general welding fume. BEFORE USE, READ AND UNDERSTAND THE SAFETY DATA SHEET (SDS) FOR THIS PRODUCT AND SPECIFIC INFORMATION PRINTED ON THE PRODUCT CONTAINER.

LINCOLN® GUARDIAN™ CF

Severe Abrasion

KEY FEATURES

- Industry leading casing wear protection
- Exceptional tool wear life
- Applicable over other hardband materials
- Weldable with or without gas shielding

TYPICAL APPLICATIONS

- Hardbanding

SHIELDING GAS (for GMAW-C)

98%Ar/2%O₂ or Ar/CO₂ blends
No shielding gas is required for FCAW-S applications

DIAMETERS / PACKAGING

Diameter in (mm)	33 lb (15 kg) Spool	45 lb (20 kg) Spool
1/16 (1.6)	ED037920	ED037921

MECHANICAL PROPERTIES⁽¹⁾

Rockwell Hardness [R _c]	Wear Resistance
58-62	ASTM G65-04 Procedure A 0.22 g mass loss

DEPOSIT COMPOSITION⁽¹⁾

%Fe	%C	%Cr	%B	%Nb	%Mn	%Si
Balance	<3	<10	<6	<9	<5	<2

TYPICAL OPERATING PROCEDURES

Diameter, Polarity ESO - in (mm)	Current (Amps)	Voltage (Volts)	Wire Feed Speed m/min (ipm)	Shielding Gas	Flow Rate (cfh)
1/16 in (1.6mm), DC+ 1/2 - 3/4 (15) GMAW-C 3/4 - 1 (20) FCAW-S	200-350	23-28 for Globular Transfer 27-33 for Spray Transfer - 98Ar/2O ₂ recommended	7.0 (275)	98%Ar/2%O ₂ or Ar/CO ₂ blends	40-60

⁽¹⁾Two layers

ADDITIONAL NOTES:

Torch Oscillation Rate: 40-70 OSC/min.
Torch Oscillation Width: 5/8 - 1 in. (16-25 mm)
Beam Tilt for Elevation Band (for 18° Groove): 17° +/- 1°
Bead Overlap: 1/8 - 1/4 in. (3-6 mm)
Max. Interpass Temp: 850°F (454°C)
Soak Heat: 50°F (10°C) max. temp. change in 4 min.
Recommended Wire Storage: On pallet in dry area.

IMPORTANT: SPECIAL VENTILATION AND/OR EXHAUST REQUIRED

Fumes from the normal use of some welding products can contain significant quantities of components - such as chromium and manganese - which can lower the 5.0 mg/m³ maximum exposure guideline for general welding fume.
BEFORE USE, READ AND UNDERSTAND THE SAFETY DATA SHEET (SDS) FOR THIS PRODUCT AND SPECIFIC INFORMATION PRINTED ON THE PRODUCT CONTAINER.

LINCOLN® SHS® 7570W

Severe Abrasion

KEY FEATURES

- Excellent corrosion resistance and high wear and impact resistance
- Especially resistant to corrosion in high chloride and seawater
- Alternative to nickel and superalloys and stainless steels

TYPICAL APPLICATIONS

- Oil & Gas
- Power Generation
- Pulp & Paper

DIAMETERS / PACKAGING

Diameter in (mm)	25 lb (11.3 kg) Spool PLW
1/16 (1.6)	ED035664

MECHANICAL PROPERTIES

Vickers Hardness (HV0.3)	Wear Resistance	Bond Strength ksi (MPa)
950-1150	ASTM G65-04 Procedure B 0.20 g mass loss	ASTM C633-01 Glue Failure 8 (55)

DEPOSIT COMPOSITION

%Fe	%C	%Cr	%B	%Mo	%W	%Mn	%Si
Balance	<2	<25	<5	<15	<5	<2	<2

TYPICAL OPERATING PROCEDURES

Tip Size in (mm)	Air Cap	Positioner	Amperes (Amps)	Voltage (V)	Air Motor (psi)	Atomizing Air (psi)	Arc Jet Air (psi)	Transverse Rate in/min (m/min)	Standoff in (mm)
1/16 (1.6)	Blue	Short Cross	200	32	50	70	80	276 (7)	6 (152)

* This procedure was developed on a TAFE 8830/8835 system. Changes in equipment, materials, and substrates may change optimum procedures. Listed procedures should only be used as a starting point.

IMPORTANT: SPECIAL VENTILATION AND/OR EXHAUST REQUIRED

Fumes from the normal use of some welding products can contain significant quantities of components - such as chromium and manganese - which can lower the 5.0 mg/m³ maximum exposure guideline for general welding fume. BEFORE USE, READ AND UNDERSTAND THE SAFETY DATA SHEET (SDS) FOR THIS PRODUCT AND SPECIFIC INFORMATION PRINTED ON THE PRODUCT CONTAINER.

LINCOLN® SHS® 8000W

Severe Abrasion

KEY FEATURES

- Excels in elevated temperature environments where fly ash and bed ash erosion occurs
- Superior bond strength without necessity of bond coat
- Hardness increases as a function of time and temperature

TYPICAL APPLICATIONS

- Boiler Tubes
- Oil & Gas
- Power Generation
- Pulp & Paper

DIAMETERS / PACKAGING

Diameter in (mm)	10 lb (4.5 kg) Carton 36 in. (914 mm) length GTAW (TIG) Rod	25 lb (11.3 kg) Spool PLW	33 lb (15 kg) Spool PLW	400 lb (181 kg) Accu-Trak Drum
0.045 (1.1)	ED037611	ED035665	ED037894	ED035972
1/16 (1.6)				
1/8 (3.2)				

MECHANICAL PROPERTIES

Vickers Hardness (HV0.3)	Wear Resistance	Bond Strength ksi (MPa)
1000-1200	ASTM G65-04 Procedure B 0.18 g mass loss	ASTM C633-01 Glue Failure 8 (55)

DEPOSIT COMPOSITION

%Fe	%C	%Cr	%B	%Mo	%Nb	%Mn	%Si
Balance	<2	<22	<5	<5	<5	<1	<1

TYPICAL OPERATING PROCEDURES

Tip Size in (mm)	Air Cap	Positioner	Amperes (Amps)	Voltage (V)	Air Motor (psi)	Atomizing Air (psi)	Arc Jet Air (psi)	Transverse Rate in/min (m/min)	Standoff in (mm)
1/16 (1.6)	Blue	Short Cross	250	32	50	70	80	276 (7)	6 (152)

* This procedure was developed on a TAFE 8830/8835 system. Changes in equipment, materials, and substrates may change optimum procedures. Listed procedures should only be used as a starting point.

IMPORTANT: SPECIAL VENTILATION AND/OR EXHAUST REQUIRED

Fumes from the normal use of some welding products can contain significant quantities of components - such as chromium and manganese - which can lower the 5.0 mg/m³ maximum exposure guideline for general welding fume. BEFORE USE, READ AND UNDERSTAND THE SAFETY DATA SHEET (SDS) FOR THIS PRODUCT AND SPECIFIC INFORMATION PRINTED ON THE PRODUCT CONTAINER.

LINCOLN® SHS® 9172W

Severe Abrasion

KEY FEATURES

- Excels in extreme environments where severe abrasion is encountered
- Significant ability to withstand corrosion and high temperature oxidation
- Exceptional wear resistance in applications involving fine particle abrasion and erosion

TYPICAL APPLICATIONS

- LPA Screens
- Oil & Gas
- Power Generation
- Pulp & Paper

DIAMETERS / PACKAGING

Diameter in (mm)	25 lb (11.3 kg) Spool PLW
1/16 (1.6)	ED035666

MECHANICAL PROPERTIES

Vicker's Hardness (HV0.3)	Wear Resistance	Bond Strength ksi (MPa)
975 - 1025	ASTM G65-04 Procedure B 0.17 g mass loss	ASTM C633-01 Glue Failure 6 (41)

DEPOSIT COMPOSITION

%Fe	%C	%Cr	%B	%Mo	%Nb	%W	%Mn	%Si
Balance	<4	<25	<5	<6	<12	<15	<3	<2

TYPICAL OPERATING PROCEDURES

Tip Size in (mm)	Air Cap	Positioner	Amperes (Amps)	Voltage (V)	Air Motor (psi)	Atomizing Air (psi)	Arc Jet Air (psi)	Transverse Rate in/min (m/min)	Standoff in (mm)
1/16 (1.6)	Blue	Short Cross	200	32	50	70	80	276 (7)	6 (152)

* This procedure was developed on a TAFE 8830/8835 system. Changes in equipment, materials, and substrates may change optimum procedures. Listed procedures should only be used as a starting point.

IMPORTANT: SPECIAL VENTILATION AND/OR EXHAUST REQUIRED

Fumes from the normal use of some welding products can contain significant quantities of components - such as chromium and manganese - which can lower the 5.0 mg/m³ maximum exposure guideline for general welding fume. BEFORE USE, READ AND UNDERSTAND THE SAFETY DATA SHEET (SDS) FOR THIS PRODUCT AND SPECIFIC INFORMATION PRINTED ON THE PRODUCT CONTAINER.

LINCOLN® SHS® 7574HV

Severe Abrasion

KEY FEATURES

- Outstanding corrosion resistance in high chlorine, salt fog, concentrated salt and seawater environments
- Can be finished to very high surface specifications for use as a replacement for hard chrome
- High bond strength, low porosity and high impact resistance
- Corrosion resistance is superior to crystalline austenitic stainless steel and nickel based superalloys

TYPICAL APPLICATIONS

- Oil & Gas
- Power Generation
- Mining
- Pulp & Paper
- Offshore & Marine

DIAMETERS / PACKAGING

Size Micron (µm)	10 lb (4.5 kg) Bottle	25 lb (11.3 kg) Pail
+15/-53	ED035730	ED035731

MECHANICAL PROPERTIES

Vicker's Hardness (HV0.3)	Wear Resistance	Bond Strength ksi (MPa)
975 - 1075	ASTM G65-04 Procedure B 0.13 g mass loss	ASTM C633-01 Glue Failure 10 (69)

DEPOSIT COMPOSITION

%Fe	%C	%Cr	%B	%Mo	%Mn	%Si	%W
Balance	<3	<25	<5	<20	<5	<2	<10

TYPICAL OPERATING PROCEDURES

Feeder Speed (rpm)	Gas Flow (cfh)	Powder Feed Rate lb/hr (g/min)	Spray Distance in (mm)	Deposit Rate (mil/pass)
270 (6 pitch screw)	21	5 (37.8)	14 (356)	0.5-0.7
Fuel Flow Rate gal/hr (l/min)	Fuel Pressure (psi)	Oxygen Flow Rate (cfh)	Oxygen Pressure (psi)	Combustion (psi)
6 (0.45)	120	2100	135	100

* This procedure was developed on a TAFE JP5000. Changes in equipment, materials, and substrates may change optimum procedures. Listed procedures should only be used as a starting point.

IMPORTANT: SPECIAL VENTILATION AND/OR EXHAUST REQUIRED

Fumes from the normal use of some welding products can contain significant quantities of components - such as chromium and manganese - which can lower the 5.0 mg/m³ maximum exposure guideline for general welding fume. BEFORE USE, READ AND UNDERSTAND THE SAFETY DATA SHEET (SDS) FOR THIS PRODUCT AND SPECIFIC INFORMATION PRINTED ON THE PRODUCT CONTAINER.

LINCOLN® SHS® 8000HV

Severe Abrasion

KEY FEATURES

- Excels in high abrasion, erosion environments, both wet and dry
- Very good metal to metal (two body) wear resistance
- Superior bond strength without necessity of bond coat
- Can be finished to very high surface specifications

TYPICAL APPLICATIONS

- Oil & Gas
- Power Generation
- Mining
- Pulp & Paper

DIAMETERS / PACKAGING

Size Micron (µm)	10 lb (4.5 kg) Bottle	25 lb (11.3 kg) Pail
+15/-53	ED035732	ED035733

MECHANICAL PROPERTIES

Vicker's Hardness (HV0.3)	Wear Resistance	Bond Strength ksi (MPa)
1000	ASTM G65-04 Procedure B 0.07 g mass loss	ASTM C633-01 Glue Failure 10 (69)

DEPOSIT COMPOSITION

%Fe	%C	%Cr	%B	%Mo	%Nb	%Mn	%Si	%W
Balance	<4	<25	<5	<6	<12	<3	<2	<12

TYPICAL OPERATING PROCEDURES

Feeder Speed (rpm)	Gas Flow (cfh)	Powder Feed Rate lb/hr (g/min)	Spray Distance in (mm)	Deposit Rate (mil/pass)
270 (6 pitch screw)	21	10 (75.6)	14 (356)	0.2-0.4
Fuel Flow Rate gal/hr (l/min)	Fuel Pressure (psi)	Oxygen Flow Rate (cfh)	Oxygen Pressure (psi)	Combustion (psi)
6 (0.45)	120	1900	135	100

* This procedure was developed on a TAFA JP5000. Changes in equipment, materials, and substrates may change optimum procedures. Listed procedures should only be used as a starting point.

<p>IMPORTANT: SPECIAL VENTILATION AND/OR EXHAUST REQUIRED</p> <p>Fumes from the normal use of some welding products can contain significant quantities of components - such as chromium and manganese - which can lower the 5.0 mg/m³ maximum exposure guideline for general welding fume.</p> <p>BEFORE USE, READ AND UNDERSTAND THE SAFETY DATA SHEET (SDS) FOR THIS PRODUCT AND SPECIFIC INFORMATION PRINTED ON THE PRODUCT CONTAINER.</p>
--

LINCOLN® SHS® 9172HV

Severe Abrasion

KEY FEATURES

- Excels in high sulfur and elevated temperature environments where fly-ash and bed-ash erosion occurs
- Exceptional abrasion resistance for a metallic material
- Significant corrosion and high temperature oxidation resistance
- Very high bond strength across a range of substrate materials, including aluminum, copper, carbon steel and stainless steel.
- Can be finished to very high surface specifications as a replacement for hard chrome
- Hardness and corrosion and wear resistance is superior to hard chrome

TYPICAL APPLICATIONS

- Oil & Gas
- Power Generation
- Mining
- Pulp & Paper

DIAMETERS / PACKAGING

Size Micron (µm)	10 lb (4.5 kg) Bottle	25 lb (11.4 kg) Pail
+15/-53	ED035734	ED035735

MECHANICAL PROPERTIES

Vicker's Hardness (HV0.3)	Wear Resistance	Bond Strength ksi (MPa)
1000 - 1100	ASTM G65-04 Procedure B 0.07 g mass loss	ASTM C633-01 Glue Failure 10 (69)

DEPOSIT COMPOSITION

%Fe	%C	%Cr	%B	%Mo	%Nb	%W	%Mn	%Si
Balance	<4	<25	<5	<6	<12	<15	<3	<2

TYPICAL OPERATING PROCEDURES

Feeder Speed (rpm)	Gas Flow (cfh)	Powder Feed Rate (lb/hr (g/min))	Spray Distance (in (mm))	Deposit Rate (mil/pass)
270 (6 pitch screw)	21	10 (75.6)	14 (356)	0.2-0.4
Fuel Flow Rate (gal/hr (l/min))	Fuel Pressure (psi)	Oxygen Flow Rate (cfh)	Oxygen Pressure (psi)	Combustion (psi)
6 (0.45)	120	1900	135	100

* This procedure was developed on a TAFA JP5000. Changes in equipment, materials, and substrates may change optimum procedures. Listed procedures should only be used as a starting point.

IMPORTANT: SPECIAL VENTILATION AND/OR EXHAUST REQUIRED

Fumes from the normal use of some welding products can contain significant quantities of components - such as chromium and manganese - which can lower the 5.0 mg/m³ maximum exposure guideline for general welding fume. BEFORE USE, READ AND UNDERSTAND THE SAFETY DATA SHEET (SDS) FOR THIS PRODUCT AND SPECIFIC INFORMATION PRINTED ON THE PRODUCT CONTAINER.

LINCOLN® SHS® 9294P

Severe Abrasion

KEY FEATURES

- Alternative to 65% tungsten carbide PAW materials
- Provides exceptional uniformity of hardness and wear performance across a range of service environments

TYPICAL APPLICATIONS

- Crusher Rolls
- Screw Augers
- Ore Chutes

DIAMETERS / PACKAGING

Size Micron (µm)	10 lb (4.5 kg) Bottle
+53/-180	ED037599

MECHANICAL PROPERTIES⁽¹⁾

Rockwell Hardness (R _c)	Wear Resistance
71-74	ASTM G65-04 Procedure A 0.08 g mass loss

DEPOSIT COMPOSITION⁽¹⁾

%Fe	%C	%Cr	%B	%Mo	%Nb	%W	%Mn	%Si	%V
Balance	<5	<20	<10	<10	<10	<15	<5	<2	<5

TYPICAL OPERATING PROCEDURES

Current (Amps)	Voltage (Volts)	Powder Feed Rate lb/hr (g/min)	Shielding Gas	Flow Rate (cfh)	Plasma Gas
190	23	6 [45]	100% Ar	25	100% Ar
Oscillation in (mm)	Oscillation Rate (hz)	Dwell Time (s)	Slew Time (s)	Travel Speed in/min (mm/min)	
0.75 [19]	1	0.05	0.5	3.5 [89]	

⁽¹⁾ Composition and properties depend upon dilution. Single layer deposit properties depend upon base metal and/or build-up material.

* This procedure was developed on a Eutectic GAP 375 power source and a Eutectic GAP E52 torch. Changes in equipment, materials, and substrates may change optimum procedures. Listed procedures should only be used as a starting point.

<p>IMPORTANT: SPECIAL VENTILATION AND/OR EXHAUST REQUIRED</p> <p>Fumes from the normal use of some welding products can contain significant quantities of components - such as chromium and manganese - which can lower the 5.0 mg/m³ maximum exposure guideline for general welding fume.</p> <p>BEFORE USE, READ AND UNDERSTAND THE SAFETY DATA SHEET (SDS) FOR THIS PRODUCT AND SPECIFIC INFORMATION PRINTED ON THE PRODUCT CONTAINER.</p>
--

LINCOLN® SHS® 9700P

Severe Abrasion

KEY FEATURES

- Economical iron-based alternative to nickel based materials containing tungsten carbide
- Good resistance to abrasion and erosion from fine particles
- Highly refined microstructure

TYPICAL APPLICATIONS

- Wearplate
- Crusher Rolls
- Ore Chutes
- Screw Augers

DIAMETERS / PACKAGING

Size Micron (µm)	10 lb (4.5 kg) Bottle	25 lb (11.3 kg) Pail
+53/-180	ED035724	ED035725

MECHANICAL PROPERTIES⁽¹⁾

Rockwell Hardness (R _c)	Wear Resistance
67-69	ASTM G65-04 Procedure A 0.13 g mass loss

DEPOSIT COMPOSITION⁽¹⁾

%Fe	%C	%Cr	%B	%Nb	%Mn	%Si
Balance	<2	<21	<7	<6	<2	<2

TYPICAL OPERATING PROCEDURES

Current (Amps)	Voltage (Volts)	Powder Feed Rate lb/hr (g/min)	Shielding Gas	Flow Rate (cfh)	Plasma Gas
180	22	3.3-3.9 (25-29)	95 Ar – 5 H ₂	25	100% Ar
Oscillation in (mm)	Oscillation Rate (hz)	Dwell Time (s)	Slew Time (s)	Travel Speed in/min (mm/min)	
0.6 (15)	1	0.1	0.4	3.5 (89)	

* This procedure was developed on a Eutectic GAP 375 power source and a Eutectic GAP E52 torch. Changes in equipment, materials, and substrates may change optimum procedures. Listed procedures should only be used as a starting point.

<p>IMPORTANT: SPECIAL VENTILATION AND/OR EXHAUST REQUIRED</p> <p>Fumes from the normal use of some welding products can contain significant quantities of components - such as chromium and manganese - which can lower the 5.0 mg/m³ maximum exposure guideline for general welding fume. BEFORE USE, READ AND UNDERSTAND THE SAFETY DATA SHEET (SDS) FOR THIS PRODUCT AND SPECIFIC INFORMATION PRINTED ON THE PRODUCT CONTAINER.</p>

CONSUMABLES

CHROME-MOLY



B2**1.25% Cr, 0.5% Mo for high-temperature service**

CHROMET 1X	SMAW	I-2
Lincoln ER80S-B2	GTAW	I-14
SuperArc Orbital TIG ER80S-B2	GTAW	I-33
ER80S-B2	GMAW/GTAW	I-10
CORMET 1	FCAW	I-31
Lincolnweld LA-92	SAW	I-23

B3**2.25% Cr, 1.0% Mo for high-temperature service**

CHROMET 2X	SMAW	I-3
CROMO E225	SMAW	I-7
Lincolnweld ER90S-B3	TIG	I-15
SuperArc Orbital TIG ER90S-B3	TIG	I-34
ER90S-B3	GMAW/GTAW	I-12
CORMET 2	FCAW	I-32
Lincolnweld LA-93	SAW	I-24
OP CROMO F537	SAW	I-28

22V**2.25% Cr-1.0% Mo-V for high-temperature service**

CROMO E225V	SMAW	I-8
CARBOROD W 225V	GTAW	I-18

B6**5% Cr, 0.50% Mo for high-temperature service**

CHROMET 5	SMAW	I-9
5CRMO TIG	GTAW	I-17
5CRMO SAW	SAW	I-22

B8**9% Cr, 1.0% Mo martensitic alloy steel for high-temperature service**

CHROMET 9	SMAW	I-4
9CRMO	GMAW/GTAW	I-11
9CRMO	SAW	I-21

P91**Modified 9Cr steel designed to weld equivalent P91 steels**

CHROMET 9-B9	SMAW	I-5
CHROMET 9MV-N	SMAW	I-6
9CRMOV-N	GTAW	I-16
9CRMOV	GMAW	I-13
SUPERCORE F91	FCAW	I-30
9CRMOV-N	SAW	I-26
0E-S1 CRM091	SAW	I-25
OP 90W	SAW	I-27
LA490	SAW	I-29

P92**Modified 9Cr steel designed to weld equivalent P92 steels**

CHROMET 92	SMAW	I-1
9CRWV TIG	GTAW	I-19
9CRWV SAW	SAW	I-20

CHROMET 92

Low Alloy, Low Hydrogen · AWS E9015-B92 H4

KEY FEATURES

- B9 (P92) alloyed steel: 9Cr steel designed to weld equivalent 'type 92' steels modified with tungsten, vanadium, niobium, nitrogen, and a small addition of boron to give improved long term creep properties
- P92 steel has rupture strength up to 30% greater than that of P91 steel
- Moisture resistant coating provides low amounts of weld metal hydrogen levels for a superior weld
- Specifically designed for high integrity structural service at elevated temperature

WELDING POSITIONS

All, except vertical down

CONFORMANCES

AWS A5.5:	E9015-B92 H4
BS EN ISO 3580-A:	E ZCrMoWVNb 9 0.5 2 B 3 2 H5

TYPICAL APPLICATIONS

- Main Steam Piping
- Oil Refineries
- Coal Liquefaction and Gasification Plants
- Power Generation Plants
- Turbine Castings

DIAMETERS / PACKAGING

Diameter mm (in)	3.7kg (8.2lb) Can	4.2kg (9.3lb) Can	4.3kg (9.5lb) Can
2.5 (3/32)	CH92-25-1	CH92-32-1	CH92-40-1
3.2 (1/8)			
4.0 (5/32)			

MECHANICAL PROPERTIES⁽¹⁾ – As Required per AWS A5.5/A5.5M

	Yield Strength ⁽²⁾ MPa (ksi)	Tensile Strength MPa (ksi)	Elongation %	Charpy V-Notch J (ft-lbf) @20°C (68°F)
Requirements - AWS E9015-B92 H4	530 (77) min	620 (90) min	17 min	-
Typical Results⁽³⁾ - PWHT 2-4 hr @ 760°C (1400°F)	630 (91)	740 (108)	22	60 [44]
High Temperature - 550°C	419 (61)	511 (74)	15	-
600°C	320 (46)	422 (61)	19.5	-
650°C	229 (33)	340 (49)	19.5	-

DEPOSIT COMPOSITION – As Required per AWS A5.5/A5.5M

	%C	%Mn	%Si	%S	%P	%Cr	%Ni	%Mo
Requirements - AWS E9015-B92 H4	0.08-0.13	0.4-1.0	0.40 max	0.015 max	0.020 max	8.0-9.5	0.80 max	0.30-0.60
Typical Results⁽³⁾	0.11	0.6	0.25	0.010	0.010	9.0	0.60	0.45
	%W	%Nb	%V	%N	%B	%Al	%Cu	
Requirements - AWS E9015-B92 H4	1.5-2.0	0.04-0.07	0.15-0.25	0.03-0.07	0.001-0.005	0.03 max	0.15 max	
Typical Results⁽³⁾	1.7	0.05	0.20	0.05	0.003	<0.01	<0.05	

TYPICAL OPERATING PROCEDURES

Polarity	Current (Amps)		
	2.5mm (3/32in)	3.2mm (1/8in)	4.0mm (5/32in)
DC+ or AC	70-110	80-140	100-180

⁽¹⁾Typical all weld metal. ⁽²⁾Measured with 0.2% offset. ⁽³⁾See test results disclaimer ⁽⁴⁾CTWD (Contact Tip to Work Distance). Subtract 1/4 in (6.4 mm) to calculate Electrical Stickout.
⁽⁵⁾Procedures in these areas are procedures for short circuiting mode using 100% CO₂. When using 75% Argon, 25% CO₂ for short circuit transfer, reduce voltage by 1 to 2 volts.

CHROMET[®] 1X

Low Alloy, Low Hydrogen · AWS E8018-B2 H4

KEY FEATURES

- B2 alloyed steel: 1.25% chromium, 0.5% molybdenum deposit which meets specific requirements for improved temper embrittlement resistance with prolonged service at 400°C-600°C (752°F-1112°F)
- Excellent corrosion resistance in refineries to sulfur bearing crude oil at 250°C-450°C (482°F-842°F)
- Moisture resistant coating provides low amounts of weld metal hydrogen levels for a superior weld
- Weld metal chemistry is low in impurity elements allowing it to respect the X Factor (<15ppm) and J-factor (<120ppm)

WELDING POSITIONS

All, except vertical down

DIAMETERS / PACKAGING

Diameter mm (in)	3.9kg (8.6lb) Easy Open Can	4.1kg (9.0lb) Easy Open Can	5.5kg (12.1lb) Easy Open Can
2.5 (3/32)	CHROMET1X-25-1	CHROMET1X-32-1	CHROMET1X-40-1 CHROMET1X-50-1
3.2 (1/8)			
4.0 (5/32)			
5.0 (3/16)			

MECHANICAL PROPERTIES⁽¹⁾ – As Required per AWS A5.5/A5.5M

	Yield Strength ⁽²⁾ MPa (ksi)	Tensile Strength MPa (ksi)	Elongation %	Charpy V-Notch J (ft-lbf)		Hardness	
				@20°C (68°F)	@-30°C (-22°F)	AW	PWHT
Requirements AWS E8018-B2 H4	460 [67]	550 [80] min	19 min	47 min	–		–
Typical Performance							
As-Welded							
1 hr @ 690°C (1274°F)	525 [76]	610 [88]	25	160 [118]	100 [74]	300-320	200-210
Stress-Relieved							
5 hr @ 690°C (1274°F)	515 [75]	610 [88]	29	200 [148]	160 [118]	–	220
5 hr @ 690°C (1274°F) + SC ⁽³⁾	490 [71]	595 [86]	29	200 [148]	140 [103]		190

DEPOSIT COMPOSITION⁽¹⁾ – As Required per AWS A5.5/A5.5M

	%C	%Mn ⁽⁴⁾	%Si ⁽⁴⁾	%S	%P
Requirements E8018-B2 H4	0.05 - 0.10	05.0 - 0.50	0.15 - 0.30	0.015 max	0.012 max
Typical Performance	0.06	0.70	0.25	0.012	0.009
	%Cr	%Mo	%Cu	%Sn	%As
Requirements AWS E8018-B2 H4	1.00 - 1.40	0.45 - 0.65	0.15 max	0.005 max	0.010 max
Typical Performance	1.25	0.55	<0.05	0.002	0.003

TYPICAL OPERATING PROCEDURES

Polarity ⁽⁴⁾	Current (Amps)			
	2.5 mm (3/32 in)	3.2 mm (1/8 in)	4.0 mm (5/32 in)	5.0 mm (3/16 in)
DC+ or AC	70-110	80-140	100-180	140 - 240

⁽¹⁾ Typical all weld metal ⁽²⁾ Measured with 0.2% offset ⁽³⁾ See test results disclaimer ⁽⁴⁾ Preferred polarity is listed first. ⁽⁵⁾ C= step cooled

CHROMET[®] 2X

Low Alloy, Low Hydrogen · AWS E9018-B3 H4

KEY FEATURES

- B3 alloyed steel: 2.25% chromium, 1% molybdenum deposit which meets specific requirements for improved temper embrittlement resistance with prolonged service at 400°C-600°C (752°F-1112°F)
- Excellent corrosion resistance in refineries to sulfur bearing crude oil at 250°C-450°C (482°F-842°F)
- Moisture resistant coating provides low amounts of weld metal hydrogen levels for a superior weld
- Weld metal chemistry is low in impurity elements allowing it to respect the X Factor (<15ppm) and J-factor (<120ppm)

WELDING POSITIONS

All, except vertical down

CONFORMANCES

AWS A5.5M:	E9018-B3 H4
BS EN ISO 3580-A:	E CrMo2 B 3 2 H5
BS EN ISO 3580-B:	E 6216-2C1M

TYPICAL APPLICATIONS

- Petro-Chemical
- Turbine Castings
- Power Plants
- Boiler Superheaters
- Piping
- Steam Chests
- Valve Bodies
- Heat Exchangers
- Fractionators

DIAMETERS / PACKAGING

Diameter mm (in)	4.0kg (8.8lb) Easy Open Can	5.2kg (11.5lb) Easy Open Can	5.6kg (12.3lb) Easy Open Can
2.5 (3/32)	CHROMET2X-25-1		
3.2 (1/8)	CHROMET2X-32-1		
4.0 (5/32)			CHROMET2X-40-1
5.0 (3/16)		CHROMET2X-50-1	

MECHANICAL PROPERTIES⁽¹⁾ – As Required per AWS A5.5/A5.5M

	Yield Strength ⁽²⁾ MPa (ksi)	Tensile Strength MPa (ksi)	Elongation %	Charpy V-Notch J (ft-lbf)		Hardness	
				@-30°C (-22°F)	@20°C (68°F)	AW	PWHT
Requirements AWS E9018-B3 H4	540 (78) min	630 (91) min	17 min	-	47 (35)	-	-
Typical Performance							
PWHT 1 hr @ 690°C (1274°F) (SC= step cooled)	570 (83)	670 (97)	22	80 (59)	140 (103)	300-320	220-250
Stress Relieved							
690°C/ 5hr typical	560 (81)	550 (80)	27	140 (103)	170 (125)	-	195
690°C/ 5hr+ SC typical	660 (96)	650 (94)	25	110 (81)	170 (125)	-	205

DEPOSIT COMPOSITION⁽¹⁾ – As Required per AWS A5.5/A5.5M

	%C	%Mn ⁽³⁾	%Si ⁽³⁾	%S	%P	
Requirements AWS E9018-B3 H4	0.05-0.10	0.50-0.90	0.15-.30	0.015 max	0.012 max	
Typical Performance	0.06	0.70	0.25	0.012	0.010	
	%Cr	%Mo	%Cu	%Sn	%As	%Sb
Requirements AWS E9018-B3 H4	2.00-2.50	0.90-1.20	0.15 max	0.005 max	0.010 max	0.005 max
Typical Performance	2.25	1.05	<0.05	0.002	0.003	<0.002

TYPICAL OPERATING PROCEDURES

Polarity ⁽⁴⁾	Current (Amps)			
	2.5 mm (3/32 in)	3.2 mm (1/8 in)	4.0 mm (5/32 in)	5.0 mm (3/16 in)
DC+ or AC	70-110	80-140	100-180	140-240

⁽¹⁾ Typical all weld metal ⁽²⁾ Measured with 0.2% offset ⁽³⁾ See test results disclaimer ⁽⁴⁾ Preferred polarity is listed first. ⁽⁵⁾ C= step cooled

CHROMET[®] 9

Low Alloy, Low Hydrogen · AWS E8015-B8 H4

KEY FEATURES

- B8 alloyed steel: 9% chromium, 1% molybdenum martensitic alloy steel for elevated temperature service up to 600°C (1112°F)
- Designed for high strength and improved corrosion resistance in superheated steam, hot hydrogen gas and high sulphur crude oils where higher performance than 5% chromium, 0.5% molybdenum steel is required
- Moisture resistant coating provides low amounts of weld metal hydrogen levels for a superior weld
- Weld metal chemistry is low in impurity elements allowing it to respect the X Factor (<15ppm) and J-factor (<120ppm)

WELDING POSITIONS

All, except vertical down

CONFORMANCES

AWS A5.5:	E8015-B8 H4
BS EN ISO 3580-A:	E CrMo9 B 3 2 H5
BS EN ISO 3580-B:	E 6216-9C1M

TYPICAL APPLICATIONS

- Oil Refineries
- Power Plants
- Pressure Vessels
- Heat Exchangers
- Steam Piping

DIAMETERS / PACKAGING

Diameter mm (in)	11.7 kg (26 lb) Carton	13.5 kg (30 lb) Carton	17.4 kg (38 lb) Carton
2.5 (3/32)	CHROMET9-25-1	CHROMET9-32-1	CHROMET9-40-1
3.2 (1/8)			
4.0 (5/32)			

MECHANICAL PROPERTIES^(a) – As Required per AWS A5.5/A5.5M

	Yield Strength ^(b) MPa (ksi)	Tensile Strength MPa (ksi)	Elongation %	Charpy V-Notch J (ft-lbf)		Hardness HV
				@20°C (68°F)	@-10°C (14°F)	
Requirements AWS E8015-B8 H4	530 (77) min	590 (86) min	19 min	34 min	-	-
Typical Performance^(b) After 2 hours of PWHT at 740C (1364F)	600 (87)	710 (103)	22	90	25	235

DEPOSIT COMPOSITION^(a) – As Required per AWS A5.5/A5.5M

	%C	%Mn	%Si	%S	%P
Requirements AWS E8015-B8 H4	0.05-0.10	0.50-1.00	0.60 max	0.025 max	0.025 max
Typical Performance^(b)	0.06	0.75	0.35	0.012	0.015
	%Cr	%Ni	%Mo	%Cu	
Requirements AWS E8015-B8 H4	8.0-10.0	0.40 max	0.90-1.20	0.3 max	
Typical Performance^(b)	9.0	0.20	1.00	<0.05	

TYPICAL OPERATING PROCEDURES

Polarity ^(d)	Current (Amps)		
	2.5 mm (3/32 in)	3.2 mm (1/8 in)	4.0 mm (5/32 in)
DC+ or AC	70-110	80-140	100-180

^(a) Typical all weld metal ^(b) Measured with 0.2% offset ^(c) See test results disclaimer ^(d) Preferred polarity is listed first.

CHROMET® 9-B9

Low Alloy, Low Hydrogen · AWS E9015-B91 H4

KEY FEATURES

- B9 (P91) alloyed steel: Modified 9CrMo designed to weld equivalent "type 91" 9CrMo steels modified with small additions of niobium, vanadium and nitrogen for improved long term creep resistance
- Moisture resistant coating provides low amounts of weld metal hydrogen levels for a superior weld
- Specifically designed for high integrity structural service at elevated temperature
- Weld metal chemistry is low in impurity elements allowing it to respect the X Factor (<15ppm) and J-factor (<120ppm)

WELDING POSITIONS

All, except vertical down

DIAMETERS / PACKAGING

Diameter mm (in)	4.5 kg (10 lb) Easy Open Can	5 kg (11 lb) Easy Open Can	5.5 kg (12 lb) Easy Open Can
2.5 (3/32)	CH9B9-25-1		
3.2 (1/8)	CH9B9-32-1		
4.0 (5/32)		CH9B9-40-1	
5.0 (3/16)			CH9B9-50-1

MECHANICAL PROPERTIES⁽¹⁾ - As Required per AWS A5.5/A5.5M

	Yield Strength ⁽²⁾ MPa (ksi)	Tensile Strength MPa (ksi)	Elongation %	Charpy V-Notch J (ft-lbf) @ 20°C (68°F)	Hardness HV10 ⁽⁴⁾ @ PWHT
Requirements - AWS E9015-B91 H4	530 (77) min	620 (90) min	17 min	—	—
Typical Results⁽³⁾					
Room Temperature					
PWHT 2 hr @ 760°C (1400°F)	590 (86)	710 (103)	22	75 (55)	240
High Temperature					
550°C (1022°F)	>360 (52)	>450 (65)	—	—	—
600°C (1112°F)	>255 (37)	>375 (54)	—	—	—
650°C (1202°F)	>175 (25)	>285 (41)	—	—	—

DEPOSIT COMPOSITION⁽¹⁾ - As Required per AWS A5.5/A5.5M

	%C	%Mn ⁽⁵⁾	%Si ⁽⁶⁾	%S	%P	%Cr	
Requirements - AWS E9015-B91 H4	0.08 - 0.12	0.40 - 0.75	0.30 max	0.01 max	0.01 max	8.0 - 10.0	
Typical Results⁽³⁾	0.10	0.55	0.25	<0.01	<0.01	9.0	
	%Ni ⁽⁶⁾	%Mo	%Nb	%V	%Cu	%Al	%N
Requirements - AWS E9015-B91 H4	0.2 - 0.4	0.85 - 1.20	0.03 - 0.07	0.15 - 0.25	0.25 max	0.04 max	0.03-0.07
Typical Results⁽³⁾	0.3	1.00	0.04	0.20	0.05	0.01	0.05

TYPICAL OPERATING PROCEDURES

Polarity	Current (Amps)			
	2.5mm (3/32in)	3.2mm (1/8in)	4.0mm (5/32in)	5.0mm (3/16in)
DC+ or AC	70 - 110	80 - 140	100 - 180	140 - 240

⁽¹⁾Typical all weld metal. ⁽²⁾Measured with 0.2% offset. ⁽³⁾See test results disclaimer. ⁽⁴⁾Industry specific data, not required by AWS.

⁽⁵⁾Ni + Mn < 1.0%. Nickel is below 0.4% (as parent metal) although AWS allows up to 1.0%Ni. See Chromet 9MV-N or Chromet 9MVN+ for variant with 0.4 - 1.0%Ni conforming to EN ISO specification.

NOTE: Additional test data available upon request.

CHROMET® 9MV-N

Low Alloy, Low Hydrogen · AWS E9015-B91 H4

KEY FEATURES

- B9 (P91) alloyed steel: Modified 9CrMo designed to weld equivalent "type 91" 9CrMo steels modified with small additions of niobium, vanadium and nitrogen for improved long term creep resistance
- Moisture resistant coating provides low amounts of weld metal hydrogen levels for a superior weld
- Specifically designed for high integrity structural service at elevated temperature
- Includes Ni addition and lower Nb for improved toughness

CONFORMANCES

AWS A5.5: E9015-B91 H4
BS EN ISO 3580-A: E CrMo91 B 3 2 H5

TYPICAL APPLICATIONS

- Power Generating Plants
- Main Steam Piping
- Turbine Casting
- Oil Refineries
- Coal Liquefaction and Gasification Plants

WELDING POSITIONS

All, except vertical down

DIAMETERS / PACKAGING

Diameter mm (in)	4.3kg (9.5lb) Can
2.5 (3/32)	CH9MVN-25

MECHANICAL PROPERTIES⁽¹⁾ – As Required per AWS A5.5/A5.5M

	Yield Strength ⁽²⁾ MPa (ksi)	Tensile Strength MPa (ksi)	Elongation %	Charpy V-Notch J [ft·lbf] @20°C (68°F)	Hardness After PWHT	Hardness As Welded
Requirements AWS E9015-B91 H4	530 (77) min	620 (90) min	17 min	47	-	-
Typical Performance⁽³⁾ After 2 hours PWHT at 760°C (1400°F)	640 (93)	770 (112)	22	65	250	450

DEPOSIT COMPOSITION⁽¹⁾ – As Required per AWS A5.5/A5.5M

	%C	%Mn	%Si	%S	%P	%Cr	%Ni
Requirements AWS E9015-B91 H4	0.08-0.12	0.50-1.20	0.30 max	0.01 max	0.01 max	8.0-10.0	0.4-0.8
Typical Performance⁽³⁾	0.10	0.60	0.25	<0.01	0.01	9.0	0.7
	%Mo	%Cu	%N	%Nb	%V	Ni+Mn	
Requirements AWS E9015-B91 H4	0.85-1.20	0.25 max	0.03-0.07	0.04-0.07	0.15-0.25	1.5 max	
Typical Performance⁽³⁾	1.00	0.05	0.05	0.05	0.20	1.3	

TYPICAL OPERATING PROCEDURES

Polarity ⁽⁴⁾	Current (Amps) 2.5 mm (3/32 in)
DC+ or AC	70-110

⁽¹⁾ Typical all weld metal ⁽²⁾ Measured with 0.2% offset ⁽³⁾ See test results disclaimer ⁽⁴⁾ Preferred polarity is listed first.

CROMO E225

Low Alloy, Low Hydrogen · AWS E9015-B3 H4

KEY FEATURES

- B3 alloyed steel: 2.25%Cr-1%Mo basic coated stick electrode producing a low hydrogen weld metal with operating temperatures up to 600°C
- Designed for welding creep resistant and high pressure hydrogen resistant steels used in the fabrication of pressure vessels, boilers and pipe
- Weld metal features high toughness properties and is largely insensitive to in-service embrittlement proven by stimulated heat treatment step cooling
- Weld metal chemistry is low in impurity elements allowing it to respect the X Factor (<15ppm) and J-factor (<120ppm)

WELDING POSITIONS

All, except vertical down

CONFORMANCES

AWS A5.5:	E9015-B3 H4
BS EN ISO 1599:	E CrMo2 B 22 H5

TYPICAL APPLICATIONS

- Petro-Chemical
- Power Plants
- Piping
- Turbine Casting
- Steam Chests
- Valve Bodies
- Boiler Superheaters
- Heat Exchangers
- Fractionators

DIAMETERS / PACKAGING

Diameter mm [in]	4.0kg (8.8lb) Box	5.4kg (11.9lb) Box	5.5 kg (12.1lb) Box
3.2 (1/8)	W100287666	W100287668	W100287667
4.0 (5/32)			
5.0 (3/16)			

MECHANICAL PROPERTIES⁽¹⁾ – As Required per AWS A5.5/A5.5M

	Yield Strength ⁽²⁾ MPa (ksi)	Tensile Strength MPa (ksi)	Elongation %	Charpoy V-Notch J (ft-lbf) @-40°C (-40°F)
Typical Performance				
PWHT 8 hr @ 690°C (1274°F)	≥ 400 [58]	550-650 (80-94)	≥ 22	≥ 80 [59]
PWHT 8 hr @ 690°C (1274°F) + STC	≥ 400 [58]	550-650 (80-94)	≥ 22	≥ 60 [44]

DEPOSIT COMPOSITION⁽³⁾ – As Required per AWS A5.5/A5.5M

	%C	%Mn	%Si	%P	%S	%Cr	%Ni	%Mo
Requirements	0.05-0.12	0.90	1.00	0.03	0.03	2.00-2.50	-	0.90-1.20
AWS E9015-B3 H4								
Typical Performance⁽³⁾	0.10	0.70	0.25	≤0.01	≤0.01	2.30	-	1.10

TYPICAL OPERATING PROCEDURES

Polarity ⁽⁴⁾	Current (Amps)		
	3.2mm (1/8in)	4.0mm (5/32in)	5.0mm (3/16in)
DC+	85-130	140-180	180-230

⁽¹⁾ Typical all weld metal ⁽²⁾ Measured with 0.2% offset ⁽³⁾ See test results disclaimer ⁽⁴⁾ Preferred polarity is listed first.

CROMO E225V

Low Alloy, Low Hydrogen · AWS E9015-G

KEY FEATURES

- 22V alloyed steel: 2.25%Cr-1%Mo-V basic coated stick electrode that produces a low hydrogen weld metal and has excellent tensile strength at high temperatures
- Weld metal features high toughness properties and is largely insensitive to in-service embrittlement proven by stimulated heat treatment step cooling
- Weld metal chemistry is low in impurity elements allowing it to respect the X Factor (<15ppm) and J-factor (<120ppm)

WELDING POSITIONS

All, except vertical down

CONFORMANCES

AWS A5.5:	E9015-G
BS EN ISO 1599:	E Z B 22 H5

TYPICAL APPLICATIONS

- Petro-Chemical
- Power Plants
- Piping
- Turbine Casting
- Steam Chests
- Valve Bodies
- Boiler Superheaters
- Heat Exchangers
- Fractionators

DIAMETERS / PACKAGING

Diameter mm (in)	4.0kg (8.8lb) Box	5.4kg (11.9lb) Box	6.3kg (13.9lb) Box
3.2 (1/8)	W100287673	W100287675	W100287674
4.0 (5/32)			
5.0 (3/16)			

MECHANICAL PROPERTIES⁽¹⁾ – As Required per AWS A5.5/A5.5M

	Yield Strength ⁽²⁾ MPa (ksi)	Tensile Strength MPa (ksi)	Elongation %	Charpoy V-Notch J (ft-lbf) @-18°C (-0.4°F)	Hardness HV
Typical Performance PWHT 8 hr @ 710°C (1310°F)	≥ 420 (61)	620-750 (90-109)	≥ 18	≥ 54 (40)	-

DEPOSIT COMPOSITION⁽¹⁾ – As Required per AWS A5.5/A5.5M

	%C	%Mn	%Si	%P	%S	%Cr
Typical Performance⁽³⁾	0.09	0.60	0.20	≤ 0.010	≤ 0.010	2.30
	%Ni	%Mo	%Nb	%V	%N	%Cu
Typical Performance⁽³⁾	-	1.0	0.012	0.25	-	-

TYPICAL OPERATING PROCEDURES

Polarity ⁽⁴⁾	Current (Amps)		
	3.2mm (1/8in)	4.0mm (5/32in)	5.0mm (3/16in)
DC+ or AC	85-130	130-170	170-220

⁽¹⁾Typical all weld metal ⁽²⁾Measured with 0.2% offset ⁽³⁾See test results disclaimer ⁽⁴⁾Perferred polarity is listed first.

CHROMET[®] 5

Low Alloy, Low Hydrogen · AWS E8015-B6 H4

KEY FEATURES

- B6 alloyed steel: 5% chromium, 0.5% molybdenum alloyed steel for elevated temperature service up to 600°C (1112°F)
- Designed for high strength and improved corrosion resistance in superheated steam, hot hydrogen gas and high sulphur crude oils
- Moisture resistant coating provides low amounts of weld metal hydrogen levels for a superior weld
- Weld metal chemistry is low in impurity elements allowing it to respect the X Factor (<15ppm) and J-factor (<120ppm)

WELDING POSITIONS

All, except vertical down

CONFORMANCES

AWS A5.5:	E8015-B6 H4
BS EN ISO 3580-A:	E CrMo5 B 3 2 H5
BS EN ISO 3580-B:	E 6216-5CM

TYPICAL APPLICATIONS

- Boiler Superheaters
- Heat Exchangers
- Piping
- Pressure Vessels
- Nitriding

DIAMETERS / PACKAGING

Diameter mm (in)	4.1kg (9.0lb) Can	4.2kg (9.3lb) Can	5.7kg (12.6lb) Can
2.5 (3/32)	Chromet5-25-1	Chromet5-32-1	Chromet5-40-1
3.2 (1/8)			
4.0 (5/32)			

MECHANICAL PROPERTIES⁽¹⁾ – As Required per AWS A5.5

	Yield Strength ⁽²⁾ MPa (ksi)	Tensile Strength MPa (ksi)	Elongation %	Charpy V-Notch J (ft-lbf)		Hardness HV
				@20°C (68°F)	@-10°C (14°F)	
Requirements AWS E8015-B6 H4	460 (67) min	550 (80) min	19	-	-	-
Typical Performance⁽³⁾ As-Welded	500 (73) min	610 (88) min	25	150 (111)	80 (59)	210

DEPOSIT COMPOSITION⁽¹⁾ – As Required per AWS A5.5

	%C	%Mn	%Si	%S	%P
Requirements AWS E8015-B6 H4	0.05-0.10	0.50-1.00	0.80 max	0.025 max	0.030 max
Typical Performance⁽³⁾	0.06	0.80	0.40	0.010	0.015
	%Cr	%Ni	%Mo	%Cu	
Requirements AWS E8015-B6 H4	4.0-6.0	0.40 max	0.45-0.65	0.3 max	
Typical Performance⁽³⁾	5.0	0.20	0.55	<0.1	

TYPICAL OPERATING PROCEDURES

Polarity ⁽⁴⁾	Current (Amps)		
	2.5 mm (3/32 in)	3.2 mm (1/8 in)	4.0 mm (5/32 in)
DC+	70-110	80-140	100-180

⁽¹⁾ Typical all weld metal ⁽²⁾ Measured with 0.2% offset ⁽³⁾ See test results disclaimer ⁽⁴⁾ Preferred polarity is listed first.

ER80S-B2

Low Alloy, Copper Coated · AWS ER80S-B2

KEY FEATURES

- B2 alloyed steel: 1.25% chromium, 0.5% molybdenum alloyed steel consumable designed for prolonged elevated temperature service up to 550°C (1022°F)
- Excellent corrosion resistance in refineries to sulfur bearing crude oil at 250°C-450°C (482°F-842°F)
- Weld metal chemistry is low in impurity elements allowing it to respect the X Factor (<15ppm) and J-factor (<120ppm)

WELDING POSITIONS

All

SHIELDING GAS

MIG 95% Argon/ 5% CO₂
TIG 100% Argon

CONFORMANCES

AWS A5.28: ER80S-B2
BS EN ISO 21952-B: 1CM

TYPICAL APPLICATIONS

- Petro-Chemical
- Power Plants
- Piping
- Turbine Casting
- Steam Chests
- Valve Bodies
- Boiler Superheaters
- Heat Exchangers
- Fractionators

DIAMETERS / PACKAGING

Diameter mm (in)	5kg (11lb) Tube	15kg (33lb) Spool
0.8 (0.030)		MER80SB2-08
0.9 (0.035)		MER80SB2-09
1.0 (0.040)		MER80SB2-10
1.2 (0.047)		MER80SB2-12
2.4 (3/32)	TER80SB2-24	
3.2 (1/8)	TER80SB2-32	

MECHANICAL PROPERTIES⁽¹⁾ – As Required per AWS A5.28/A5.28M

	Yield Strength ⁽²⁾ MPa (ksi)	Tensile Strength MPa (ksi)	Elongation %	Charpy V-Notch J (ft-lbf) @ -10°C (14°F)
Requirements - AWS ER80S-B2	470 (68)	550 (80)	19	-
Typical Results⁽³⁾				
MIG: PWHT 4hr @ 690°C (1274°F)	480 (70)	590 (86)	26	>115 (85)
TIG: PWHT 4hr @ 690°C (1274°F)	520 (75)	635 (92)	27	>200 (148)

DEPOSIT COMPOSITION – As Required per AWS A5.28/A5.28M

	%C	%Mn	%Si	%S	%P
Requirements - AWS ER80S-B2	0.07-0.12	0.4-0.7	0.4-0.7	0.020 max	0.020 max
Typical Results⁽³⁾	0.10	0.5	0.5	0.010	0.015
	%Cr	%Mo	%Ni	%Cu	
Requirements - AWS ER80S-B2	1.2-1.5	0.40-0.65	0.2 max	0.35 max	
Typical Results⁽³⁾	1.3	0.50	<0.1	0.10	

TYPICAL OPERATING PROCEDURES

	Polarity	Diameter mm (in)	Current (Amps)	Voltage (Volts)
MIG	DC+	1.2 (0.047)	280	26
TIG	DC-	2.4 (3/32)	100	12

⁽¹⁾Typical all weld metal. ⁽²⁾Measured with 0.2% offset. ⁽³⁾See test results disclaimer ⁽⁴⁾CTWD [Contact Tip to Work Distance]. Subtract 1/4 in [6.4 mm] to calculate Electrical Stickout.
⁽⁵⁾Procedures in these areas are procedures for short circuiting mode using 100% CO₂. When using 75% Argon, 25% CO₂ for short circuit transfer, reduce voltage by 1 to 2 volts.

9CRMO

Low Alloy, Copper Coated · AWS ER80S-B8

KEY FEATURES

- B8 alloyed steel: 9% chromium, 1% molybdenum martensitic alloy for elevated temperature service up to 600°C (1112°F)
- Designed for high strength and improved corrosion resistance in superheated steam, hot hydrogen gas and high sulphur crude oils where higher performance than 5% chromium, 0.5% molybdenum steels is required
- Weld metal chemistry is low in impurity elements allowing it to respect the X Factor (<15ppm) and J-factor (<120ppm)

WELDING POSITIONS

All

SHIELDING GAS

MIG 5-20% CO₂ /Argon

TIG 100% Argon*

*Also required as a purge for root passes

CONFORMANCES

AWS A5.28: ER80S-B8

BS EN ISO 21952-A: CrMo9

TYPICAL APPLICATIONS

- Heat Exchangers
- Furnace Piping
- Pressure Vessels
- Oil Refineries
- Boiler superheater tubing

DIAMETERS / PACKAGING

Diameter mm (in)	5kg (11lb) Spool	15kg (33lb) Spool
1.2 (0.047)		M9CRMO-12
2.0 (5/64)	T9CRMO-20	
2.4 (3/32)	T9CRMO-24	
3.2 (1/8)	T9CRMO-32	

MECHANICAL PROPERTIES⁽¹⁾ – As Required per AWS A5.28/A5.28M

	Yield Strength ⁽²⁾ MPa (ksi)	Tensile Strength MPa (ksi)	Elongation %	Charpy V-Notch J (ft-lbf) @20°C (68°F)
Requirements - AWS ER80S-B8	470 (68)	590 (86)	17	-
Typical Results⁽³⁾				
TIG: PWHT 1hr @ 745°C (1373°F)	612 (89)	730 (106)	27	80 (59)

DEPOSIT COMPOSITION – As Required per AWS A5.28/A5.28M

	%C	%Mn	%Si	%S	%P
Requirements - AWS ER80S-B8	0.06-0.10	0.40-0.60	0.30-0.50	0.020 max	0.020 max
Typical Results⁽³⁾	0.07	0.50	0.40	0.010	0.015
	%Cr	%Ni	%Mo	%Cu	
Requirements - AWS ER80S-B8	8.5-10.0	0.50 max	0.80-1.20	0.35 max	
Typical Results⁽³⁾	9.0	0.10	0.90	0.10	

TYPICAL OPERATING PROCEDURES

	Polarity	Diameter mm (in)	Current (Amps)	Voltage (Volts)
MIG	DC+	1.2 (0.047)	260	26
TIG	DC-	2.4 (3/32)	140	14

⁽¹⁾Typical all weld metal. ⁽²⁾Measured with 0.2% offset. ⁽³⁾See test results disclaimer ⁽⁴⁾CTWD [Contact Tip to Work Distance]. Subtract 1/4 in [6.4 mm] to calculate Electrical Stickout.
⁽⁵⁾Procedures in these areas are procedures for short circuiting mode using 100% CO₂. When using 75% Argon, 25% CO₂ for short circuit transfer, reduce voltage by 1 to 2 volts.

ER90S-B3

Low Alloy, Copper Coated · AWS ER90S-B3

KEY FEATURES

- B3 alloyed steel: 2.25% chromium, 1% molybdenum alloyed steel consumable designed for prolonged elevated temperature service up to 600°C (1112°F)
- Excellent corrosion resistance in refineries to sulfur bearing crude oil at 250°C-450°C (482°F-842°F)
- Weld metal chemistry is low in impurity elements allowing it to respect the X Factor (<15ppm) and J-factor (<120ppm)

WELDING POSITIONS

All

SHIELDING GAS

MIG: 95% Ar/ 5% CO₂

TIG: 100% Ar

DIAMETERS / PACKAGING

Diameter mm (in)	15 kg (33.lb) Spool	5kg (11lb) Spool
0.8 (0.030)	MER90SB3-08	
0.9 (0.035)	MER90SB3-09	
1.0 (0.040)	MER90SB3-10	
1.2 (0.047)	MER90SB3-12	
2.4 (3/32)		TER90SB3-24
3.2 (1/8)		TER90SB3-32

MECHANICAL PROPERTIES⁽¹⁾ – As Required per AWS A5.28/A5.28M

	Yield Strength ⁽²⁾ MPa (ksi)	Tensile Strength MPa (ksi)	Elongation %	Charpy V-Notch J (ft-lbf) @ -10°C (14°F)	Hardness HV
Requirements AWS ER90S-B3	540 (78) min	620 (90) min	17 min	-	-
Typical Results⁽³⁾ MIG: PWHT 1hr @ 690°C (1274°F)	540 (78)	655 (95)	23	>95	220
Typical Results TIG: PWHT 1hr @ 690°C (1274°F)	550 (80)	665 (96)	27	>150 (111)	225

WIRE COMPOSITION⁽¹⁾ – As Required per AWS A5.28/A5.28M

	%C	%Mn	%Si	%S	%P
Requirements AWS ER90S-B3	0.07-0.12	0.40-0.70	0.40-0.70	0.02 max	0.02 max
Typical Results⁽³⁾	0.10	0.50	0.50	0.01	>0.02
	%Cr	%Ni	%Mo	%Cu	
Requirements AWS ER90S-B3	2.3-2.7	0.20 max	0.9-1.1	0.35 max	
Typical Results⁽³⁾	2.4	<0.1	1.0	0.10	

TYPICAL OPERATING PROCEDURES

	Diameter mm (in)	Polarity	Current (Amps)	Voltage (Volts)
MIG	1.2 (0.045)	DC+	280A	26V
TIG	2.4 (3/32)	DC-	100A	12V

⁽¹⁾Typical all weld metal ⁽²⁾Measured with 0.2% offset ⁽³⁾See test results disclaimer

9CRMV MIG

Low Alloy Steel · AWS ER90S-B9

KEY FEATURES

- B9 (P91) alloyed steel: Modified 9CrMo designed to weld equivalent "type 91" 9CrMo steels modified with small additions of niobium, vanadium and nitrogen for improved long term creep resistance
- Specifically designed for high integrity structural service at elevated temperature
- Non-copper coated solid wire with Ni+Mn<1.0%
- Weld metal chemistry is low in impurity elements allowing it to respect the X Factor (<15ppm) and J-factor (<120ppm)

WELDING POSITIONS

All

SHIELDING GAS

5-20% CO₂ /Argon

CONFORMANCES

AWS A5.28: ER90S-B9

BS EN ISO 21952-A: G 9C1MV

TYPICAL APPLICATIONS

- Main Steam Piping
- Oil Refineries
- Coal Liquefaction and Gasification Plants
- Power Generation Plants
- Turbine Castings

DIAMETERS / PACKAGING

Diameter mm [in]	15kg [33lb] Spool
1.0 [0.040]	M9CRMV-10

MECHANICAL PROPERTIES⁽¹⁾ – As Required per AWS A5.28/A5.28M

	Yield Strength ⁽²⁾ MPa [ksi]	Tensile Strength MPa [ksi]	Elongation %	Charpy V-Notch J [ft-lbf] @20°C (68°F)
Requirements - AWS ER90S-B9	415 [60]	620 [90]	17	47 [35] min

DEPOSIT COMPOSITION – s Required per AWS A5.28/A5.28M

	%C	%Mn	%Si	%S	%P	%Cr	%Ni
Requirements - AWS ER90S-B9	0.08-0.13	0.40-0.80	0.15-0.50	0.010 max	0.010 max	8.5-9.5	0.10-0.40
Typical Results ⁽³⁾	0.10	0.50	0.25	0.005	0.008	8.7	0.30
	%Mo	%Nb	%V	%N	%Cu	%Al	
Requirements - AWS ER90S-B9	0.85-1.10	0.03-0.08	0.15-0.25	0.03-0.07	0.10 max	0.04 max	
Typical Results ⁽³⁾	1.0	0.05	0.20	0.05	0.03	<0.01	

TYPICAL OPERATING PROCEDURES

Polarity	Diameter mm [in]	Current (Amps)	Voltage (Volts)
DC+	1.2 [0.047]	280	26

⁽¹⁾Typical all weld metal. ⁽²⁾Measured with 0.2% offset. ⁽³⁾See test results disclaimer. ⁽⁴⁾CTWD [Contact Tip to Work Distance]. Subtract 1/4 in [6.4 mm] to calculate Electrical Stickout.
⁽⁵⁾Procedures in these areas are procedures for short circuiting mode using 100% CO₂. When using 75% Argon, 25% CO₂ for short circuit transfer, reduce voltage by 1 to 2 volts.

LINCOLN® ER80S-B2

Low Alloy Steel · AWS ER80S-B2

KEY FEATURES

- B2 alloyed steel: 1.25% chromium, 0.5% molybdenum alloyed steel consumable designed for prolonged elevated temperature service up to 550°C (1022°F)
- Excellent corrosion resistance in refineries to sulfur bearing crude oil at 250°C-450°C (482°F-842°F)
- Q2 Lot®- Certificate showing actual wire chemistry and mechanical properties available online
- Weld metal chemistry is low in impurity elements allowing it to respect the X Factor (<15ppm) and J-factor (<120ppm)

WELDING POSITIONS

All

CONFORMANCES

AWS A5.28: ER80S-B2

TYPICAL APPLICATIONS

- Petro-Chemical
- Power Plants
- Piping
- Turbine Casting
- Steam Chests
- Valve Bodies
- Boiler Superheaters
- Heat Exchangers
- Fractionators

SHIELDING GAS

100% Argon

DIAMETERS / PACKAGING

Diameter in (mm)	10 lb (4.5 kg) Plastic Tube 30 lb (13.6 kg) Master Carton
1/16 (1.6)	ED034343
3/32 (2.4)	ED034344
1/8 (3.2)	ED034345

WIRE COMPOSITION⁽¹⁾ – As Required per AWS A5.28/A5.28M

	%C	%Mn	%Si	%Cr	%Mo	%S	%P	%Cu	%Ni	%Zr
Requirements - AWS ER80S-B2	0.07-0.12	0.40-0.70	0.40-0.70	1.20-1.50	0.40-0.65	0.025 max	0.025 max	0.35 max	0.20 max	-
Typical Results	0.09-0.12	0.52-0.60	0.49-0.60	1.32-1.38	0.43-0.54	0.003 max	0.003	0.18	0.07	0.001 max

LINCOLN® ER90S-B3

Low Alloy Steel · AWS ER90S-B3

KEY FEATURES

- B3 alloyed steel: 2.25% chromium, 1% molybdenum alloyed steel consumable designed for prolonged elevated temperature service up to 600°C (1112°F)
- Excellent corrosion resistance in refineries to sulfur bearing crude oil at 250°C-450°C (482°F-842°F)
- Q2 Lot®- Certificate showing actual wire chemistry and mechanical properties available online
- Weld metal chemistry is low in impurity elements allowing it to respect the X Factor (<15ppm) and J-factor (<120ppm)

WELDING POSITIONS

All

CONFORMANCES

AWS A5.28: ER90S-B3

TYPICAL APPLICATIONS

- Petro-Chemical
- Power Plants
- Piping
- Turbine Casting
- Steam Chests
- Valve Bodies
- Boiler Superheaters
- Heat Exchangers
- Fractionators

SHIELDING GAS

100% Argon

DIAMETERS / PACKAGING

Diameter in (mm)	10 lb (4.5 kg) Plastic Tube 30 lb (13.6 kg) Master Carton
1/16 (1.6)	ED034357
3/32 (2.4)	ED034358
1/8 (3.2)	ED034359

MECHANICAL PROPERTIES⁽¹⁾ – As Required per AWS A5.28

	Yield Strength ⁽²⁾ MPa (ksi)	Tensile MPa (ksi)	Elongation on 4d (%)	Charpy V-Notch @-28°C (-20°F) J (ft-lbf)	Hardness (Rockwell B)
Requirements - ER90S-B3	540 (78) min	620 (90) min	17 min	-	-
TIG (100% Argon)	575-620 (83-90)	690-725 (100-105)	22-24	250-264 (185-195)	95-97

WIRE COMPOSITION⁽¹⁾ – As Required per AWS A5.28

	%C	%Mn	%Si	%S	%P	%Cr	%Ni	%Mo	%Cu
Requirements AWS ER90S-B3	0.07-0.12	0.40-0.70	0.40-0.70	0.025 max	0.025 max	2.30-2.70	0.20 max	0.90-1.20	0.35 max
Test Results ⁽³⁾	0.10	0.56-0.58	0.53-0.54	0.003-0.004	0.005	2.40	0.03-0.04	1.02-1.04	0.06-0.08

⁽¹⁾Typical all weld metal. ⁽²⁾Measured with 0.2% offset. ⁽³⁾See test results disclaimer

9CRM0V-N

Low Alloy Steel · AWS ER90S-B9

KEY FEATURES

- B9 (P91) alloyed steel: Modified 9CrMo designed to weld equivalent "type 91" 9CrMo steels modified with small additions of niobium, vanadium and nitrogen for improved long term creep resistance
- Specifically designed for high integrity structural service at elevated temperature
- Non-copper coated solid wire
- Weld metal chemistry is low in impurity elements allowing it to respect the X Factor (<15ppm) and J-factor (<120ppm)

WELDING POSITIONS

All

CONFORMANCES

AWS A5.28: ER90S-B9
BS EN ISO 21952-A: W CrMo91

TYPICAL APPLICATIONS

- Main Steam Piping
- Oil Refineries
- Coal Liquefaction and Gasification Plants
- Power Generation Plants
- Turbine Castings

SHIELDING GAS

100% Argon

DIAMETERS / PACKAGING

Diameter mm (in)	5 kg (11 lb) Tube
2.0 (5/64)	T9CRM0VN-20
2.4 (3/32)	T9CRM0VN-24
3.2 (1/8)	T9CRM0VN-32

MECHANICAL PROPERTIES⁽¹⁾ - As Required per AWS A5.28/A5.28M

	Yield Strength ⁽²⁾ MPa (ksi)	Tensile Strength MPa (ksi)	Elongation %		Charpy V-Notch J (ft-lbf) @ 20°C (68°F)	Hardness HV ₁₀ ⁽⁴⁾
			4.0 dia.	5.0 dia.		
Requirements AWS ER90S-B9	415 (60) min	620 (90) min	17 min	16 min	–	–
Typical Results⁽³⁾ Stress-Relieved @ 760°C (1400°F) for 2 hrs	675 (98)	780 (113)	22	19	220 (162)	265

WIRE COMPOSITION⁽¹⁾ - As Required per AWS A5.28/A5.28M

	%C	%Mn	%Si	%S	%P	%Cr	%Ni
Requirements AWS ER90S-B9	0.08 - 0.13	0.40 - 0.80	0.15 - 0.50	0.010 max	0.010 max	8.5 - 9.5	0.40 - 0.80
Typical Results⁽³⁾	0.10	0.50	0.25	0.006	0.008	9.0	0.60
	%Mo	%Nb	%V	%N	%Cu	%Al	
Requirements AWS ER90S-B9	0.85 - 1.10	0.03 - 0.08	0.15 - 0.25	0.03 - 0.07	0.10 max	0.04 max	
Typical Results⁽³⁾	1.00	0.05	0.20	0.05	0.03	<0.01	

TYPICAL OPERATING PROCEDURES

Polarity	Diameter mm (in)	Current (Amps)	Voltage (Volts)
DC-	2.4 (3/32)	100	12

⁽¹⁾Typical all weld metal. ⁽²⁾Measured with 0.2% offset. ⁽³⁾See test results disclaimer ⁽⁴⁾Industry specific data, not required by AWS.
 NOTE: Additional test data available upon request.

5CRMO TIG

Low Alloy Steel · AWS ER80S-B6

KEY FEATURES

- B6 alloyed steel: 5% chromium, 0.5% molybdenum alloyed steel for elevated temperature service up to 600°C (1112°F)
- Designed for high strength and improved corrosion resistance in superheated steam, hot hydrogen gas and high sulphur crude oils
- Weld metal chemistry is low in impurity elements allowing it to respect the X Factor (<15ppm) and J-factor (<120ppm)

WELDING POSITIONS

All

CONFORMANCES

AWS A5.28: ER80S-B6
BS EN ISO 21952-A: CrMo5Si

TYPICAL APPLICATIONS

- Boiler Superheaters
- Heat Exchangers
- Piping
- Pressure Vessels
- Nitriding

SHIELDING GAS

100% Argon

DIAMETERS / PACKAGING

Diameter mm (in)	5kg (11lb) Tube
2.4 (3/32)	T5CRMO-24
3.2 (1/8)	T5CRMO-32

MECHANICAL PROPERTIES⁽¹⁾ – As Required per AWS A5.28/A5.28M

	Yield Strength ⁽²⁾ MPa (ksi)	Tensile Strength MPa (ksi)	Elongation %	Charpy V-Notch J (ft-lbf) @20°C (68°F)
Requirements - AWS ER80S-B6	470 (68) min	590 (86) min	17 min	-
Typical Results⁽³⁾ PWHT 1hr @ 745°C (1373°F)	530 (77)	640 (93)	28	240 (177)
PWHT 2hr @ 740°C (1364°F)	440 (64)	570 (83)	25	-

WIRE COMPOSITION COMPOSITION – As Required per AWS A5.28/A5.28M

	%C	%Mn	%Si	%S	%P
Requirements - AWS ER80S-B6	0.03-0.10	0.40-0.70	0.30-0.50	0.020 max	0.020 max
Typical Results⁽³⁾	0.07	0.5	0.40	0.01	0.01
	%Cr	%Mo	%Ni	%Cu	%V
Requirements - AWS ER80S-B6	5.5-6.0	0.50-0.65	0.30 max	0.30 max	0.03 max
Typical Results⁽³⁾	5.7	0.55	0.10	0.20	0.02

TYPICAL OPERATING PROCEDURES

Polarity	Diameter mm (in)	Current (Amps)	Voltage (Volts)
DC-	2.4 (3/32)	140	14

⁽¹⁾Typical all weld metal. ⁽²⁾Measured with 0.2% offset. ⁽³⁾See test results disclaimer. ⁽⁴⁾CTWD [Contact Tip to Work Distance]. Subtract 1/4 in [6.4 mm] to calculate Electrical Stickout.
⁽⁵⁾Procedures in these areas are procedures for short circuiting mode using 100% CO₂. When using 75% Argon, 25% CO₂ for short circuit transfer, reduce voltage by 1 to 2 volts.

CARBOROD W 225V

Low Alloy Steel · A5.28 ER90S-G

KEY FEATURES

- 22V alloyed steel: 2.25% chromium, 1% molybdenum, 0.25% vanadium alloyed steel designed for the welding of creep resistant steels
- Designed for high creep resistance, hydrocracks in the petrochemical industry, and hydrogen service for heavy wall pressure vessels
- Copper coated TIG rod created with a very low impurity deposit

WELDING POSITIONS

All

CONFORMANCES

AWS A5.28: ER90S-G

TYPICAL APPLICATIONS

- Petro-chemical
- Pressure Vessels
- Piping

SHIELDING GAS

100% Argon

DIAMETERS / PACKAGING

Diameter mm (in)	5 kg (11 lb) Tube
2.4 (3/32)	W000289159

MECHANICAL PROPERTIES⁽¹⁾ - As Required per AWS A5.28

	Yield Strength ⁽²⁾ MPa (ksi)	Tensile Strength MPa (ksi)	Elongation %	Charpy V-Notch J (ft·lbf) @-29°C (-20°F)
Typical Results ⁽³⁾ PWHT 8 hr @ 710°C (1310°F)	≥ 500 (73)	≥ 680 (99)	≥ 18	≥ 100 (74)

WIRE COMPOSITION⁽¹⁾ - As Required per AWS A5.28

	%C	%Mn	%Si	%Cr	%Mo	%Nb	%V
Typical Results ⁽³⁾	≤ 0.13	≤ 1.0	≤ 0.2	2.5	1.0	0.02	0.25

⁽¹⁾Typical all weld metal. ⁽²⁾Measured with 0.2% offset. ⁽³⁾See test results disclaimer ⁽⁴⁾Industry specific data, not required by AWS.
NOTE: Additional test data available upon request.

9CRWV TIG

Low Alloy Steel · AWS ER90S-G (92)

KEY FEATURES

- B9 (P92) alloyed steel: 9Cr steel designed to weld equivalent 'type 92' steels modified with tungsten, vanadium, niobium, nitrogen, and a small addition of boron to give improved long term creep properties
- P92 steel has rupture strength up to 30% greater than that of P91 steel
- Non-copper coated TIG rod specifically designed for high integrity structural service at elevated temperature
- Weld metal chemistry is low in impurity elements allowing it to respect the X Factor (<15ppm) and J-factor (<120ppm)

WELDING POSITIONS

All

CONFORMANCES

AWS A5.28: ER90S-G (92)
BS EN ISO 21952-A: W ZCrMoWVNb 9 0.5 1.5

TYPICAL APPLICATIONS

- Main Steam Piping
- Oil Refineries
- Coal Liquefaction and Gasification Plants
- Power Generation Plants
- Turbine Castings

SHIELDING GAS

100% Argon

DIAMETERS / PACKAGING

Diameter mm [in]	5kg (11lb) Tube
2.0 [5/64]	T9CRWV-20
2.4 [3/32]	T9CRWV-24
3.2 [1/8]	T9CRWV-32

MECHANICAL PROPERTIES⁽¹⁾ – As Required per A5.28/A5.28M

	Yield Strength ⁽²⁾ MPa [ksi]	Tensile Strength MPa [ksi]	Elongation %	Charpy V-Notch J [ft-lbf] @20°C [68°F]
Requirements - AWS ER90S-G (92)	440 [64] min	620 [90] min	16 min	-
Typical Results⁽³⁾ 2-4 hr @ 760°C [1400°F]	700 [102]	800 [116]	22	220 [162]
High Temperature - 550°C	374 [276]	455 [336]	24.5	-
600°C	282 [208]	387 [285]	20.5	-
650°C	200 [148]	312 [230]	28	-

WIRE COMPOSITION COMPOSITION – As Required per AWS A5.28/A5.28M

	%C	%Mn	%Si	%S	%P	%Cr	%Ni	%Mo
Requirements - AWS ER90S-G (92)	0.08-0.13	0.40-0.80	0.40 max	0.015 max	0.015 max	8.0-9.5	0.80 max	0.30-0.60
Typical Results⁽⁴⁾	0.10	0.75	0.30	0.0054	0.008	9.0	0.50	0.45
	%W	%Nb	%V	%N	%B	%Al	%Cu	
Requirements - AWS ER90S-G (92)	1.5-2.0	0.04-0.07	0.15-0.25	0.03-0.07	0.001-0.005	0.03 max	0.15 max	
Typical Results⁽⁵⁾	1.7	0.06	0.20	0.05	0.003	<0.01	<0.05	

TYPICAL OPERATING PROCEDURES

Polarity	Diameter mm [in]	Current (Amps)	Voltage (Volts)
DC+	2.4 [3/32]	100	12

⁽¹⁾Typical all weld metal. ⁽²⁾Measured with 0.2% offset. ⁽³⁾See test results disclaimer. ⁽⁴⁾CTWD [Contact Tip to Work Distance]. Subtract 1/4 in [6.4 mm] to calculate Electrical Stickout.
⁽⁵⁾Procedures in these areas are procedures for short circuiting mode using 100% CO₂. When using 75% Argon, 25% CO₂ for short circuit transfer, reduce voltage by 1 to 2 volts.

SUPERARC® ORBITAL TIG ER80S-B2

Low Alloy Steel · AWS ER80S-B2

KEY FEATURES

- B2 alloyed steel: 1.25% chromium, 0.5% molybdenum alloyed steel consumable designed for prolonged elevated temperature service up to 550°C (1022°F)
- Excellent corrosion resistance in refineries to sulfur bearing crude oil at 250°C-450°C (482°F-842°F)
- Capable of exceeding AWS minimum requirement of 550 MPa (80 ksi) tensile strength after 8 hours of stress relieving at 620°C (1150°F)
- Weld metal chemistry is low in impurity elements allowing it to respect the X Factor (<15ppm) and J-factor (<120ppm)

CONFORMANCES

AWS A5.28: ER80S-B2

TYPICAL APPLICATIONS

- Petro-Chemical
- Power Plants
- Piping
- Turbine Casting
- Steam Chests
- Valve Bodies
- Boiler Superheaters
- Heat Exchangers
- Fractionators

WELDING POSITIONS

All

SHIELDING GAS

100% Argon

DIAMETERS / PACKAGING

Diameters in (mm)	2 lb (1 kg) Plastic Spool 8 lb (3.6 kg) Master Carton	10 lb (4.5 kg) Plastic Spool
0.035 (0.9)	ED034465	ED034469
0.045 (1.1)	ED034466	ED034470

WIRE COMPOSITION - As Required per AWS A5.28

	%C	%Mn	%Si	%Ni	%P
Requirements - AWS ER80S-B2	0.07-0.12	0.40-0.70	0.40-0.70	0.20 max	0.025 max
Typical Results ⁽¹⁾	0.10-0.11	0.56-0.57	0.54-0.55	0.03-0.14	0.003-0.005
	%S	%Cr	%Mo	%Cu	
Requirements - AWS ER80S-B2	0.025 max	1.20-1.50	0.40-0.65	0.35 max	
Typical Results ⁽¹⁾	0.003-0.004	1.35-1.40	0.49-0.52	0.20-0.23	

⁽¹⁾See test results disclaimer

SUPERARC® ORBITAL TIG ER90S-B3

Low Alloy Steel · AWS ER90S-B3

KEY FEATURES

- B3 alloyed steel: 2.25% chromium, 1% molybdenum alloyed steel consumable designed for prolonged elevated temperature service up to 600°C (1112°F)
- Excellent corrosion resistance in refineries to sulfur bearing crude oil at 250°C-450°C (482°F-842°F)
- Capable of exceeding AWS minimum requirement of 6200 MPa (90 ksi) tensile strength after 8 hours of stress relieving at 690°
- Weld metal chemistry is low in impurity elements allowing it to respect the X Factor (<15ppm) and J-factor (<120ppm)

CONFORMANCES

AWS A5.28: ER90S-B3

TYPICAL APPLICATIONS

- Petro-Chemical
- Power Plants
- Piping
- Turbine Casting
- Steam Chests
- Valve Bodies
- -oiler Superheaters
- Heat Exchangers
- Fractionators

WELDING POSITIONS

All

SHIELDING GAS

100% Argon

DIAMETERS / PACKAGING

Diameters in (mm)	2 lb (1 kg) Plastic Spool 8 lb (3.6 kg) Master Carton	10 lb (4.5 kg) Plastic Spool
0.035 (0.9)		ED034471
0.045 (1.1)	ED034468	

WIRE COMPOSITION - As Required per AWS A5.28

	%C	%Mn	%Si	%Ni	%P
Requirements - AWS ER90S-B3	0.07-0.12	0.40-0.70	0.40-0.70	0.20 max	0.025 max
Typical Results ⁽¹⁾	0.09-0.10	0.53-0.57	0.53-0.57	0.03-0.04	0.004
	%S	%Cr	%Mo	%Cu	
Requirements - AWS ER90S-B3	0.025 max	2.30-2.70	0.90-1.20	0.35 max	
Typical Results ⁽¹⁾	0.003- 0.004	2.38-2.42	0.99-1.02	0.06	

⁽¹⁾See test results disclaimer

9CRWV SAW

Low Alloy Solid Electrode - AWS EG [92]

KEY FEATURES

- B9 (P92) alloyed steel: 9Cr steel designed to weld equivalent 'type 92' steels modified with tungsten, vanadium, niobium, nitrogen, and a small addition of boron to give improved long term creep properties
- P92 steel has rupture strength up to 30% greater than that of P91 steel
- Non-copper coated SAW electrode specifically designed for high integrity structural service at elevated temperature
- Weld metal chemistry is low in impurity elements allowing it to respect the X Factor (<15ppm) and J-factor (<120ppm)

RECOMMENDED FLUXES

OP 9W
OP 90W

CONFORMANCES

AWS A5.23 EG [92]
BS EN ISO 21952-A S ZCrMoWVNb 9 0.5 1.5

TYPICAL APPLICATIONS

- Main Steam Piping
- Oil Refineries
- Coal Liquefaction and Gasification Plants
- Power Generation Plants
- Turbine Castings

DIAMETERS / PACKAGING

Diameter mm [in]	25kg (55lb) Spool
2.4 (3/32)	SA9CRWV-24
3.2 (1/8)	SA9CRWV-32

MECHANICAL PROPERTIES⁽¹⁾ – As Required per AWS A5.23/A5.23M

	Yield Strength ⁽²⁾ MPa [ksi]	Tensile Strength MPa [ksi]	Elongation %	Charpy V-Notch J [ft-lbf] @20°C [68°F]
Requirements - AWS EG [92]	440 [64] min	620 [90] min	16 min	-
Typical Results ⁽³⁾ 2-4 hr @ 760°C [1400°F]	700 [102]	800 [116]	22	220 [162]
High Temperature - 550°C	374 [276]	455 [336]	24.5	-
600°C	282 [208]	387 [285]	20.5	-
650°C	200 [148]	312 [230]	28	-

DEPOSIT COMPOSITION – As Required per AWS A5.23/A5.23M

	%C	%Mn	%Si	%S	%P	%Cr	%Ni	%Mo
Requirements - AWS EG [92]	0.08-0.13	0.40-0.80	0.40 max	0.015 max	0.015 max	8.0-9.5	0.80 max	0.30-0.60
Typical Results ⁽³⁾	0.10	0.75	0.30	0.005	0.008	9.0	0.50	0.45
	%W	%Nb	%V	%N	%B	%Al	%Cu	
Requirements - AWS EG [92]	1.5-2.0	0.04-0.07	0.15-0.25	0.03-0.07	0.001-0.005	0.03 max	0.15 max	
Typical Results ⁽³⁾	1.7	0.06	0.20	0.05	0.003	<0.01	<0.05	

TYPICAL OPERATING PROCEDURES

Polarity	Diameter mm [in]	Current (Amps)	Voltage (Volts)
DC+	2.4 (3/32)	420	28

⁽¹⁾Typical all weld metal. ⁽²⁾Measured with 0.2% offset. ⁽³⁾See test results disclaimer. ⁽⁴⁾CTWD [Contact Tip to Work Distance]. Subtract 1/4 in [6.4 mm] to calculate Electrical Stickout.
⁽⁵⁾Procedures in these areas are procedures for short circuiting mode using 100% CO₂. When using 75% Argon, 25% CO₂ for short circuit transfer, reduce voltage by 1 to 2 volts.

9CRMO

Low Alloy Solid Electrode · AWS EB8

KEY FEATURES

- B8 alloyed steel: 9% chromium, 1% molybdenum martensitic alloy for elevated temperature service up to 600°C (1112°F)
- Designed for high strength and improved corrosion resistance in superheated steam, hot hydrogen gas and high sulphur crude oils where higher performance than 5% chromium, 0.5% molybdenum steels is required
- Supplied in 25kg precision layer wound spools
- Weld metal chemistry is low in impurity elements allowing it to respect the X Factor (<15ppm) and J-factor (<120ppm)

CONFORMANCES

AWS A5.23	EB8
BS EN ISO 24598-A	SCrMo9

TYPICAL APPLICATIONS

- Heat Exchangers
- Piping
- Pressure Vessels
- Oil Refineries
- Boiler superheater tubing

RECOMMENDED FLUXES

OP 125W

DIAMETERS / PACKAGING

Diameter mm (in)	25kg (55lb) Spool
2.4 (3/32)	SA9CRMO-24

MECHANICAL PROPERTIES⁽¹⁾ – As Required per AWS A5.23/A5.23M

	Yield Strength ⁽²⁾ MPa (ksi)	Tensile Strength MPa (ksi)	Elongation %	Charpy V-Notch J (ft-lbf) @20°C (68°F)	Hardness HV @PWHT
Requirements - AWS EB8	435 (63) min	590 (86) min	17 min	34 min	-

DEPOSIT COMPOSITION – As Required per AWS A5.23/A5.23M

	%C	%Mn	%Si	%S	%P
Requirements - AWS EB8	0.06-0.10	0.40-0.60	0.30-0.50	0.020 max	0.020 max
Typical Results ⁽³⁾	0.07	0.50	0.40	0.01	0.015
	%Cr	%Ni	%Mo	%Cu	
Requirements - AWS EB8	8.5-10.0	0.50 max	0.80-1.20	0.35 max	
Typical Results ⁽³⁾	9.0	0.10	0.90	0.10	

TYPICAL OPERATING PROCEDURES

Polarity	Diameter mm (in)	Current (Amps)	Voltage (Volts)
DC+ or AC	2.4 (3/32)	300-500	28-36

⁽¹⁾Typical all weld metal. ⁽²⁾Measured with 0.2% offset. ⁽³⁾See test results disclaimer. ⁽⁴⁾CTWD [Contact Tip to Work Distance]. Subtract 1/4 in [6.4 mm] to calculate Electrical Stickout.
⁽⁵⁾Procedures in these areas are procedures for short circuiting mode using 100% CO₂. When using 75% Argon, 25% CO₂ for short circuit transfer, reduce voltage by 1 to 2 volts.

5CRMO SAW

Low Alloy Solid Electrode - AWS EB6

KEY FEATURES

- B6 alloyed steel: 5% chromium, 0.5% molybdenum alloyed steel for elevated temperature service up to 600°C (1112°F)
- Designed for high strength and improved corrosion resistance in superheated steam, hot hydrogen gas and high sulphur crude oils
- Weld metal chemistry is low in impurity elements allowing it to respect the X Factor (<15ppm) and J-factor (<120ppm)

RECOMMENDED FLUXES

OP 125W

CONFORMANCES

AWS A5.23 EB6
BS EN ISO 21952-A CrMo5Si

TYPICAL APPLICATIONS

- Boiler Superheaters
- Heat Exchangers
- Piping
- Pressure Vessels
- Nitriding

DIAMETERS / PACKAGING

Diameter mm (in)	25kg (55lb) Spool
2.4 (3/32)	SA5CRMO-24

MECHANICAL PROPERTIES⁽¹⁾ – As Required per AWS A5.23/A5.23M

	Yield Strength ⁽²⁾ MPa (ksi)	Tensile Strength MPa (ksi)	Elongation %	Charpy V-Notch J (ft-lbf) @20°C (68°F)
Requirements - AWS EB6	470 (68) min	590 (86) min	17 min	-
Typical Results ⁽³⁾ PWHT 1hr @ 740°C (1364°F)	470 (68)	600 (87)	27	70 (52)

WIRE COMPOSITION – As Required per AWS A5.23/A5.23M

	%C	%Mn	%Si	%S	%P
Requirements - AWS EB6	0.03-0.10	0.40-0.70	0.30-0.50	0.020 max	0.020 max
Typical Results ⁽³⁾	0.07	0.50	0.40	0.01	0.01
	%Cr	%Mo	%Ni	%Cu	%V
Requirements - AWS EB6	5.5-6.0	0.50-0.65	0.30 max	0.30 max	0.03 max
Typical Results ⁽³⁾	5.7	0.55	0.10	0.20	0.02

TYPICAL OPERATING PROCEDURES

Polarity	Diameter mm (in)	Current (Amps)	Voltage (Volts)
DC+	2.4 (3/32)	400	30

⁽¹⁾Typical all weld metal. ⁽²⁾Measured with 0.2% offset. ⁽³⁾See test results disclaimer. ⁽⁴⁾CTWD (Contact Tip to Work Distance). Subtract 1/4 in (6.4 mm) to calculate Electrical Stickout.
⁽⁵⁾Procedures in these areas are procedures for short circuiting mode using 100% CO₂. When using 75% Argon, 25% CO₂ for short circuit transfer, reduce voltage by 1 to 2 volts.

LINCOLNWELD® LA-92

Low Alloy Solid Electrode · AWS EB2R

KEY FEATURES

- B2 alloyed steel: 1.25% chromium, 0.5% molybdenum deposit which meets specific requirements for improved temper embrittlement resistance with prolonged service at 400°C-600°C (752°F-1112°F)
- Excellent corrosion resistance in refineries to sulfur bearing crude oil at 250°C-450°C (482°F-842°F)
- Actual (Type 3.1) Certificates containing chemical composition for each lot of wire are available in the Lincoln Electric Certificate Center

CONFORMANCES

AWS A5.23: EB2R
BS EN ISO: S CrMo1

RECOMMENDED FLUXES

Lincolnweld® 880M®, 882™, MIL800-H™, 960®, 822™

TYPICAL APPLICATIONS

- Petro-Chemical
- Power Plants
- Piping
- Turbine Casting
- Steam Chests
- Valve Bodies
- Boiler Superheaters
- Heat Exchangers
- Fractionators

DIAMETERS / PACKAGING

Diameter in (mm)	60 lb (27.2 kg) Coil
3/32 [2.4]	EDS30783
1/8 [3.2]	EDS26960
5/32 [4.0]	EDS26961

WIRE COMPOSITION⁽¹⁾ - As Required per AWS A5.23

	%As	%C	%Cr	%Mn	%Mo	%P
Requirements - EB2R	0.005 max	0.07-0.15	1.00-1.75	0.45-1.00	0.45-0.65	0.010 max
Typical Results	0.001	0.13	1.15	0.81	0.52	0.005
	%S	%Sb	%Si	%Sn	%Cu	
Requirements - EB2R	0.010 max	0.005 max	0.05-0.30	0.005 max	0.15 max	
Typical Results	0.006	0.001 max	0.10	0.001 max	0.07	

LINCOLNWELD® LA-93

Low Alloy Solid Electrode · AWS EB3R

KEY FEATURES

- B3 alloyed steel: 2.25% chromium, 1% molybdenum deposit which meets specific requirements for improved temper embrittlement resistance with prolonged service at 400°C-600°C (752°F-1112°F)
- Excellent corrosion resistance in refineries to sulfur bearing crude oil at 250°C-450°C (482°F-842°F)
- Actual (Type 3.1) Certificates containing chemical composition for each lot of wire are available in the Lincoln Electric Certificate Center

CONFORMANCES

AWS A5.23: EB3R
BS EN ISO: S CrMo2

RECOMMENDED FLUXES

Lincolnweld® 880M®, 882™, MIL800-H™, 960®, 822™

TYPICAL APPLICATIONS

- Petro-Chemical
- Power Plants
- Piping
- Turbine Casting
- Steam Chests
- Valve Bodies
- Boiler Superheaters
- Heat Exchangers
- Fractionators

DIAMETERS / PACKAGING

Diameter in (mm)	60 lb (27.2 kg) Coil
3/32 (2.4)	EDS30784
1/8 (3.2)	EDS26962
5/32 (4.0)	EDS26963

WIRE COMPOSITION⁽¹⁾ - As Required per AWS A5.23

	%As	%C	%Cr	%Mn	%Mo	%P
Requirements - EB3R	0.005 max	0.05-0.15	2.25-3.00	0.40-0.80	0.90-1.10	0.010 max
Typical Results	0.000	0.12	2.50	0.61	0.96	0.003
	%S	%Sb	%Si	%Sn	%Cu	
Requirements - EB3R	0.010 max	0.005 max	0.05-0.30	0.005 max	0.15 max	
Typical Results	0.006	0.000	0.10	0.002	0.08	

OE-S1 CRM091

Low Alloy Solid Electrode · AWS EB91

KEY FEATURES

- B9 (P91) alloyed steel: Modified 9CrMo designed to weld equivalent 'type 91' 9CrMo steels modified with small additions of niobium, vanadium and nitrogen for improved long term creep resistance
- Specifically designed for high integrity structural service at elevated temperature
- Precision layer wound material
- Weld metal chemistry is low in impurity elements allowing it to respect the X Factor (<15ppm) and J-factor (<120ppm)

RECOMMENDED FLUXES

OP 90W
OP 9W

CONFORMANCES

AWS A5.23: EB91
BS EN ISO 24598-A: S CrMo91

TYPICAL APPLICATIONS

- Main Steam Piping
- Oil Refineries
- Coal Liquefaction and Gasification Plants
- Power Generation Plants
- Turbine Castings

DIAMETERS / PACKAGING

Diameter mm (in)	25kg (55lb) Spool
2.4 (3/32)	W000285394
3.2 (1/8)	W000285396

WIRE COMPOSITION - As Required per AWS A5.23

	%C	%Mn	%Si	%Cr	%Ni	%Mo	%Nb	%V
OE-S1 CrMo91	0.10	0.50	0.30	9.0	0.60	0.95	0.055	0.22

9CRMV-N

Low Alloy Solid Electrode · AWS EB91

KEY FEATURES

- B9 (P91) alloyed steel: Modified 9CrMo designed to weld equivalent 'type 91' 9CrMo steels modified with small additions of niobium, vanadium and nitrogen for improved long term creep resistance
- Non-copper coated solid electrode specifically designed for high integrity structural service at elevated temperature
- Weld metal chemistry is low in impurity elements allowing it to respect the X Factor (<15ppm) and J-factor (<120ppm)

RECOMMENDED FLUXES

OP 9W
OP 90W

CONFORMANCES

AWS A5.23: EB91

TYPICAL APPLICATIONS

- Main Steam Piping
- Oil Refineries
- Coal Liquefaction and Gasification Plants
- Power Generation Plants
- Turbine Castings

DIAMETERS / PACKAGING

Diameter mm (in)	25kg (55 lb) Spool
2.4 (3/32)	SA9CRMVN-24
3.2 (1/8)	SA9CRMVN-32

MECHANICAL PROPERTIES⁽¹⁾ – As Required per AWS A5.23/A5.23M

	Yield Strength ⁽²⁾ MPa (ksi)	Tensile Strength MPa (ksi)	Elongation %	Charpy V-Notch J (ft-lbf) @20°C (68°F)	Hardness HV
Requirements AWS EB91	415 (60) min	620 (90) min	16 min	-	-
Typical Performance⁽³⁾ As-Welded	610 (88)	720 (104)	25	45 (33)	230

DEPOSIT COMPOSITION⁽¹⁾ – As Required per AWS A5.23/A5.23M

	%C	%Mn	%Si	%S	%P	%Cr	%Ni
Requirements AWS EB91	0.08-0.13	0.40-0.80	0.15-0.50	0.010 max	0.010 max	8.5-9.5	0.4-0.8
Typical Performance⁽³⁾	0.1	0.5	0.25	0.006	0.008	9.0	0.6
	%Mo	%Nb	%V	%N	%Cu	%Al	
Requirements AWS EB91	0.85-1.1	0.03-0.08	0.15-0.25	0.03-0.07	0.10 max	0.04 max	
Typical Performance⁽³⁾	1.0	0.05	0.20	0.05	0.03	<0.01	

TYPICAL OPERATING PROCEDURES

Diameter mm (in)	Polarity	Current (Amps)	Voltage (Volts)
2.4 (3/32)	DC+	420	28

⁽¹⁾Typical all weld metal ⁽²⁾Measured with 0.2% offset ⁽³⁾See test results disclaimer ⁽⁴⁾Preferred polarity is listed first.

OP 90W

Low Alloy Flux - EN ISO 14174- S A FB 1 55 DC H5

KEY FEATURES

- Special agglomerated flux for welding P91 and P92 high creep resistant steels
- Flux provides a maximum resistance to hot cracking at high interpass temperatures
- Flux from drybag can be used without re-drying (300-350°C)

PRODUCT INFORMATION

Basicity Index: 3

TYPICAL APPLICATIONS

- Heat Exchangers
- Pressure Vessels
- Oil Refineries
- Boiler superheater tubing

RECOMMENDED WIRES

Low Alloy Electrode
OE-S1 CrMo91, OE-S1 CrMo92, 9CRMOV, 9CRMOV-N, 9CRWV

PACKAGING

25 lb (55 kg) DryBag

W000374906

AWS TEST RESULTS

	Weld Condition	Yield Strength MPa (ksi)	Tensile Strength MPa (ksi)	Elongation (%)	Charpy V-Notch J (ft*lbF)	
					@0°C (32°F)	@20°C (68°F)
Typical Results^(a) OE-S1 CrMo91	As- Welded	≥ 540 (78)	620-760 (90-110)	≥ 17	≥ 27 (20)	≥ 50 (37)
OE-S1 CrMo92	As- Welded	≥ 540 (78)	620-760 (90-110)	≥ 17	–	≥ 50 (37)

FLUX COMPOSITION

	%CaO+MgO	%Al ₂ O ₃ +MnO	%CaF ₂	%SiO ₂ +TiO ₂
OP 90W	40	25	20	10

OP CROMO F537

Low Alloy Flux - EN ISO 760- SA FB 155 AC H5

KEY FEATURES

- Special agglomerated flux for welding creep resistant 22V and B3 steels
- Metallurgical properties include low silicon pick-up and neutral behavior regarding manganese
- Low bulk density and rate of consumption
- Able to be welded with the twin-wire process and tandem welding with two or more wire electrodes

PRODUCT INFORMATION

Basicity Index: -2.6

PACKAGING

25 lb (55 kg) DryBag

W000402695

TYPICAL APPLICATIONS

- Heat Exchangers
- Pressure Vessels
- Oil Refineries
- Boiler superheater tubing

RECOMMENDED WIRES

Low Alloy Electrode
OE CROMO S225V

AWS TEST RESULTS

	Weld Condition	Yield Strength MPa [ksi]	Tensile Strength MPa [ksi]	Elongation [%]	Charpy V-Notch	
					J (ft-lbf)	@°C (°F)
Typical Results^(a) OE-CROMO S225V	Stress Relieved	≥ 540 [78]	620-750 [90-109]	≥ 18	≥ 27[20] min	-20 [-4]

FLUX COMPOSITION

	%Al ₂ O ₃ +MnO	%SiO ₂ +TiO ₂	%CaO+MgO	%CaF ₂
OP CROMO F537	20	15	40	25

LA490

Special Neutral Flux · EN ISO 14174 SA FB 155 AC H5

KEY FEATURES

- Recommended for use with 9CrMoV-N & 9CrMoV solid wires
- Agglomerated fluoride-basic flux for P91 & P92 modified 9CrMo creep resistant steels
- Composition aids in producing crack resistant welds
- Self releasing slag

PACKAGING

25 kg (55.1 lb) Sahara ReadyBag™

FXLA490SA-25SRB

CONFORMANCES

AWS A5.23M:
(FLUX-WIRE COMBINATION)

F62P0-EB91-B91

TYPICAL APPLICATIONS

- Main Steam Piping
- Power Generation Plants
- Oil Refineries

OPERATING PARAMETERS

AC or DC+; typical 420A, 28V,
390mm/min (15.4 in/min)

FLUX COMPOSITION⁽¹⁾

	%SiO ₂ + Al ₂ O ₃	%CaO + MgO	%CaF ₂	Basicity Index (Boniszewski)
LA490	30	36	27	Approximately 3.0

AWS TEST RESULTS⁽¹⁾

Flux/Wire Combination	PWHT Condition	Yield Strength ⁽²⁾ MPa (ksi)	Tensile Strength MPa (ksi)	Elongation (%)		Charpy V-Notch		AWS Classification (A5.23M)
				4 d	5 d	J (ft-lbf)	@ °C (°F)	
9CrMoV-N	750 ^o -760 ^o /2h	610 (89)	720 (104)	25%	23%	45 (33)	20 (68)	F62P0-EB91-B91

⁽¹⁾See test results disclaimer ⁽²⁾Measured with 0.2% offset.

NOTE: If flux becomes damp, rebake at 300-350°C [572-662°F]/1-2 hours to restore to as-packed condition.

NOTE: For the most up-to-date AWS certificates of conformance please visit www.lincolnelectric.com

SUPERCORE® F91

Low Alloy, All Position · AWS E91T1-B9C/M-H4

KEY FEATURES

- B9 (P91) alloyed steel: Modified 9CrMo designed to weld equivalent "type 91" 9CrMo steels modified with small additions of niobium, vanadium and nitrogen for improved long term creep resistance, toughness fatigue and oxidation, and resistance at elevated temperatures
- Electrode provides high deposition rates and fast freezing slag for out of position welding
- Features a rutile flux system with an alloyed strip capable of producing low hydrogen weld

SHIELDING GAS

100% CO₂
80% Argon/ 20% CO₂
Flow Rate: 40-50 CFH

CONFORMANCES

AWS A5.29:	E91T1-B9C/M-H4
AWS A5.36M⁽⁵⁾:	E91T1-C1PZ-B91-H4 or E91T1-M21PZ-B91-H4
EN ISO 17634-B:	T69T1-1C/M-9C1MV

TYPICAL APPLICATIONS

- Main Steam Piping
- Oil Refineries
- Coal Liquefaction and Gasification Plants
- Power Generation Plants
- Turbine Castings

WELDING POSITIONS

All

DIAMETERS / PACKAGING

Diameter mm [in]	15 kg [33 lb] Spool
1.2 [0.045]	SCF91-12

MECHANICAL PROPERTIES⁽¹⁾

	Yield Strength ⁽²⁾ MPa (ksi)	Tensile Strength MPa (ksi)	Elongation %	Charpy V-Notch J (ft-lbf) @ 20°C (68°F)	Hardness HV
Requirements AWS E91T1-B9C/M-H4	565 (82) min	690 (100) min	17 min	–	–
Typical Results⁽³⁾ Room Temperature 2 hr @760°C (1400°F) 6 hr @ 760°C (1400°F) High Temperature +566°C (1050°F) +600°C (112°F) +650°C (1202°F)	660 (96) 630 (91) 360 (52) 288 (42) 245 (36)	790 (115) 750 (109) 450 (65) 420 (61) 396 (57)	20 23 21 27 29	28 (21) 36 (97) – – –	260 250 – – –

DEPOSIT COMPOSITION⁽¹⁾

	%C	%Mn	%Si	%S	%P	%Cr	%Ni
Requirements AWS E91T1-B9C/M-H4	0.08 - 0.13	0.60 - 1.20	0.50 max	0.015 max	0.020 max	8.0 - 10.0	0.80 max
Typical Results⁽³⁾	0.10	0.80	0.30	0.010	0.016	9.0	0.50
	%Mo	%Nb	%V	%N	%Cu	%Al	%Ni+Mn
Requirements AWS E91T1-B9C/M-H4	0.85 - 1.2	0.02 - 0.07	0.15 - 0.25	0.02 - 0.07	0.15 max	0.04 max	1.5 max
Typical Results⁽³⁾	1.0	0.04	0.20	0.05	0.05	0.01	1.3

TYPICAL OPERATING PROCEDURES⁽⁶⁾

Diameter mm [in]	Polarity	Current (Amps)	Voltage (Volts)
1.2 [0.045]	DC+	140-170	24-26

⁽¹⁾Typical all weld metal. ⁽²⁾Measured with 0.2% offset. ⁽³⁾See test results disclaimer ⁽⁴⁾Industry specific data, not required by AWS. ⁽⁵⁾Dependent on shielding gas ⁽⁶⁾Using 100%CO₂, the voltage should be increased by 1-2V
NOTE: Additional test data available upon request.

CORMET™ 1

Low Alloy, All Position · AWS E81T1-B2C/M-H4

KEY FEATURES

- B2 alloyed steel: 1.25% chromium, 0.5% molybdenum alloyed steel for prolonged elevated temperature service up to 550°C (1022°F)
- Designed for high strength and improved corrosion resistance in refineries to sulphur bearing crude oil at 250-450°C (482-842°F)

SHIELDING GAS

80% Argon / 20% CO₂
 100% CO₂
 Flow Rate: 40-50 CFH

CONFORMANCES

AWS A5.29: E81T1-B2C/M-H4
BS EN ISO 17634-B: T55T1-1C/M-1CM

TYPICAL APPLICATIONS

- Petro-Chemical
- Power Plants
- Piping
- Turbine Casting
- Steam Chests
- Valve Bodies
- Boiler Superheaters
- Heat Exchangers
- Fractionators

WELDING POSITIONS

All

DIAMETERS / PACKAGING

Diameter mm (in)	16kg (35 lb) Spool
1.2 (0.045)	CORM1-12N

MECHANICAL PROPERTIES⁽¹⁾

	Yield Strength ⁽²⁾ MPa (ksi)	Tensile Strength MPa (ksi)	Elongation %	Charpoy V-Notch J (ft-lbf)		Hardness HV
				@20°C (68°F)	@-20°C (-4°F)	
Requirements E81T1-B2C/M-H4	470 (68) min	550 (80) min	19 min	-	-	-
Typical Results⁽³⁾ PWHT 1-2 hr. @ 690° C (1274° F)	545 (79)	635 (92)	24	150	80	200

DEPOSIT COMPOSITION⁽¹⁾

	%C	%Mn	%Si	%S
Requirements E81T1-B2C/M-H4	0.05-0.12	1.25 max	0.80 max	0.030 max
Typical Results⁽³⁾	0.06	1.00	0.30	0.010
	%P	%Cr	%Mo	%Cu
Requirements E81T1-B2C/M-H4	0.030 max	1.00-1.50	0.40-0.65	0.3 max
Typical Results⁽³⁾	0.010	1.30	0.55	<0.1

TYPICAL OPERATING PROCEDURES

Diameter mm (in)	Polarity	Voltage ⁽⁴⁾ [Volts]	Current [Amps]
1.2 (0.045)	DC+	24-30	160-260

⁽¹⁾ Typical all weld metal ⁽²⁾ Measured with 0.2% offset ⁽³⁾ See test results disclaimer ⁽⁴⁾ Settings are for 80%Ar/20%CO₂ shielding gas. Increase voltage 1-2V for 100% CO₂

CORMET™ 2

Low Alloy, All Position · AWS E91T1-B3C/M-H4

KEY FEATURES

- B3 alloyed steel: 2.25% chromium, 1% molybdenum alloyed steel designed for prolonged elevated temperature service up to 600°C (1112°F)
- All-positional flux cored wire suitable for welding fixed pipework
- Designed using a high purity steel sheath for high deposition rates

WELDING POSITIONS

All

SHIELDING GAS

80% Argon / 20% CO₂
 100% CO₂
 Flow Rate: 40-50 CFH

CONFORMANCES

AWS A5.29: E91T1-B3C/M-H4
BS EN ISO 17634-B: T62T1-1C/M-2C1M

TYPICAL APPLICATIONS

- Petro-Chemical
- Power Plants
- Piping
- Turbine Casting
- Steam Chests
- Valve Bodies
- Boiler Superheaters
- Heat Exchangers
- Fractionators

DIAMETERS / PACKAGING

Diameter mm [in]	16kg (35 lb) Spool
1.2 [0.045]	CORM2-12N

MECHANICAL PROPERTIES⁽¹⁾

	Yield Strength ⁽²⁾ MPa (ksi)	Tensile Strength MPa (ksi)	Elongation %	Charpy V-Notch J (ft-lbf)		Hardness HV
				@ 20°C (68°F)	@ -20°C (-4°F)	
Requirements AWS E91T1-B3C/M-H4	540 (78) min	620 (90) min	17 min	–	–	–
Typical Results⁽³⁾ PWHT 1-2 hr. @ 690° C (1274° F)	570 (83)	680 (99)	21	150	60	220

DEPOSIT COMPOSITION⁽¹⁾

	%C	%Mn	%Si	%S
Requirements AWS E91T1-B3C/M-H4	0.05 - 0.12	1.25 max	0.80 max	0.030 max
Typical Results⁽³⁾	0.06	1.00	0.30	0.010
	%P	%Cr	%Mo	%Cu
Requirements AWS E91T1-B3C/M-H4	0.030 max	2.00 - 2.50	0.90 - 1.20	0.30 max
Typical Results⁽³⁾	0.010	2.30	1.00	0.05

TYPICAL OPERATING PROCEDURES⁽⁵⁾

Diameter mm [in]	Polarity	Voltage (Volts)	Current (Amps)
1.2 [0.045]	DC+	24-30	160-260

⁽¹⁾Typical all weld metal. ⁽²⁾Measured with 0.2% offset. ⁽³⁾See test results disclaimer. ⁽⁴⁾Industry specific data, not required by AWS. ⁽⁵⁾Settings are for 80%Ar/20%CO₂ shielding gas. Increase voltage 1-2V for 100% CO₂. NOTE: Additional test data available upon request.

CONSUMABLES

ALUMINUM & CAST IRON



SUPERGLAZE® 4043

Aluminum · AWS ER4043

KEY FEATURES

- Designed for welding heat-treatable base alloys and more specifically 6XXX series alloys
- Lower melting point and more fluidity than 5XXX series filler alloys
- Low sensitivity to weld cracking with 6XXX series base alloys
- Suitable for sustained elevated temperature service, i.e. above 65°C (150°F)
- Not recommended for materials to be anodized

WELDING POSITIONS

All, except vertical down

NOTE

- Typical Joint Designs and Operating Procedures on pg. I-14 - I-16

CONFORMANCES

AWS A5.10:	ER4043
ASME SFA 5.10:	ER4043
CWB/CSA W48-06:	ER4043
ISO 18273:	ER4043
TUV:	AlSi5
DB:	S Al 5356 (AlMg5Cr(A))
	S Al 5356 (AlMg5Cr(A))

TYPICAL APPLICATIONS

- For welding 6XXX alloys, and most casting alloys
- Automotive components such as frame and drive shafts
- Bicycle frames

SHIELDING GAS

100% Argon
Argon / Helium Mixtures
Flow Rate: 30 - 50 CFH

DIAMETERS / PACKAGING

Diameter in (mm)	1 lb (0.5 kg) Plastic Spool 20 lb (9.1 kg) Master Carton	16 lb (7.3 kg) Plastic Spool	20 lb (9.1 kg) Plastic Spool	60 lb (27.2 kg) Mini-Drum	300 lb (136 kg) Gem-Pak™ Box
0.030 (0.8)	ED030307				
0.035 (0.9)	ED030308	ED028395		ED036718 ^(a)	ED036609
3/64 (1.2)	ED030310		ED029234	ED036592	ED036610
1/16 (1.6)			ED030281	ED036719	ED036611

^(a)This part number contains glass gems.

WIRE COMPOSITION⁽¹⁾ – As Required per SFA/AWS A5.10

	%Al	%Si	%Fe	%Cu	%Mn
Requirements - AWS ER4043	Remainder	4.50-6.00	0.80 max	0.30 max	0.05 max
Typical Results⁽²⁾	Remainder	5.26	0.15	0.01	0.01
	%Mg	%Cr	%Zn	%Ti	%Be
Requirements - AWS ER4043	0.05 max	—	0.10 max	0.20 max	0.0003 max
Typical Results⁽²⁾	0.03	—	0.001	0.01	<0.0002

⁽¹⁾Typical all weld metal. ⁽²⁾See test results disclaimer

SUPERGLAZE® 4047

Aluminum · AWS ER4047

KEY FEATURES

- Lower melting point and higher fluidity than 4043 wires
- Can be used as a substitute for 4043 wires to increase silicon in the weld metal, minimize hot cracking and produce higher fillet weld shear strength

WELDING POSITIONS

All, except vertical down

NOTE

- Typical Joint Designs and Operating Procedures on pg. I-14 - I-16

CONFORMANCES

AWS A5.10:	ER4047
ASME SFA 5.10:	ER4047
EN ISO 18273:	AlSi5

TYPICAL APPLICATIONS

- Automotive components
- Heat exchangers
- Body panels
- Brazing of aluminum sheets, extrusions and castings

SHIELDING GAS

100% Argon
Argon / Helium Mixtures
Flow Rate: 30 - 50 CFH

DIAMETERS / PACKAGING

Diameter in (mm)	16 lb (7.3 kg) Plastic Spool	300 lb (136 kg) Gem-Pak™ Box
0.035 (0.9)	EDS28415	
3/64 (1.2)	EDS28417	ED036613
1/16 (1.6)	EDS28418	ED036612

WIRE COMPOSITION⁽¹⁾ – As Required per SFA/AWS A5.10

	%Al	%Si	%Fe	%Cu	%Mn
Requirements - AWS ER4047	Remainder	11.00-13.00	0.80 max	0.30 max	0.15 max
Typical Results ⁽²⁾	As Reported per AWS Requirements				
	%Mg	%Cr	%Zn	%Ti	%Be
Requirements - AWS ER4047	0.10 max	—	0.20 max	—	0.0003 max
Typical Results ⁽²⁾	As Reported per AWS Requirements				

⁽¹⁾Typical all weld metal. ⁽²⁾See test results disclaimer

SUPERGLAZE® 5183

Aluminum · AWS ER5183

KEY FEATURES

- Designed for applications where higher strength is required
- For 5083 and 5456 base materials

WELDING POSITIONS

All, except vertical down

SHIELDING GAS

100% Argon
Argon / Helium Mixtures
Flow Rate: 30 - 50 CFH

NOTE

- Typical Joint Designs and Operating Procedures on pg. I-14 - I-16

CONFORMANCES

AWS A5.10:	ER5183
ASME SFA 5.10:	ER5183
ABS/AWS:	ER5183 Ar&Ar/He
LR:	WC/I-1 S & I-5 S
DNV-GL:	5183 I-1
BV Grade:	WC
CWB/CSA W48-06:	ER5183
KR:	WC G I-1 & I-5
CCS:	WC I-1
ISO 18273:	AlMg4, 5Mn0, 7(A)
TUV and DB:	AlMg 4, 5 Mn

TYPICAL APPLICATIONS

- Marine fabrication and repair
- Cryogenic tanks
- Shipbuilding and other high strength structural aluminum applications
- Bicycle frames
- Railing industry
- Offshore industry

DIAMETERS / PACKAGING

Diameter in (mm)	1 lb (0.5 kg) Plastic Spool 20 lb (9.1 kg) Master Carton	16 lb (7.3 kg) Plastic Spool	300 lb (136 kg) Gem-Pak™ Box
0.035 (0.9)	EDS30322	EDS28437	ED034789
3/64 (1.2)			ED034791
1/16 (1.6)		EDS28438	ED034792

WIRE COMPOSITION⁽¹⁾ – As Required per SFA/AWSA5.10

	%Al	%Si	%Fe	%Cu	%Mn
Requirements - AWS ER5183	Remainder	0.40 max	0.40 max	0.10 max	0.50 - 1.00
Typical Results ⁽²⁾	Remainder	0.03	0.13	0.001	0.65
	%Mg	%Cr	%Zn	%Ti	%Be
Requirements - AWS ER5183	4.30 - 5.20	0.05 - 0.25	0.25 max	0.15 max	0.0003 max
Typical Results ⁽²⁾	4.99	0.10	0.02	0.07	0.0002

⁽¹⁾Typical all weld metal. ⁽²⁾See test results disclaimer

SUPERGLAZE® HD 5183

Aluminum · AWS ER5183

KEY FEATURES

- Designed for heavy duty applications
- Reduced shavings and improved feedability
- For 5083 and 5456 base materials

WELDING POSITIONS

All

SHIELDING GAS

100% Argon
Argon / Helium Mixtures
Flow Rate: 30 - 50 CFH for Argon

NOTE

- Typical Joint Designs and Operating Procedures on pg. I-14 - I-16

CONFORMANCES

AWS A5.10:

Lloyd's Register:

ISO 18273:

ER5183

WC/I-1

AlMg4.5Mn0.7(A)

TYPICAL APPLICATIONS

- Ideal for aggressive work environments and applications with long conduit lengths
- Marine fabrication and repair
- Cryogenic tanks
- Shipbuilding and other high strength structural aluminum applications
- Railcars
- Offshore industry

DIAMETERS / PACKAGING

Diameter in (mm)	16 lb (7.3 kg) Steel Spool	20 lb (9.1 kg) Plastic Spool	300 lb (136 kg) Gem-Pak™ Box
0.035 (0.9)	ED035690	ED035691	ED036341
3/64 (1.2)	ED035692	ED035693	ED036342
1/16 (1.6)	ED035694	ED035695	ED036343

WIRE COMPOSITION⁽¹⁾ – As Required per AWS A5.10

	%Al	%Si	%Fe	%Cu	%Mn
Requirements - AWS ER5183	Remainder	0.40 max	0.40 max	0.10 max	0.50-1.0
Typical Results⁽²⁾	Remainder	0.03	0.13	0.001	0.65
	%Mg	%Cr	%Zn	%Ti	%Be
Requirements - AWS ER5183	4.3-5.2	0.05-0.25	0.25 max	0.15 max	0.0003 max
Typical Results⁽²⁾	5.0	0.10	0.02	0.07	0.00002

⁽¹⁾Typical wire chemistry. ⁽²⁾See test results disclaimer

SUPERGLAZE® 5356

Aluminum · AWS ER5356

KEY FEATURES

- General purpose filler alloy for welding 5XXX series alloys
- The most widely used welding alloy

WELDING POSITIONS

All, except vertical down

SHIELDING GAS

100% Argon
Argon / Helium Mixtures
Flow Rate: 30 - 50 CFH

NOTE

- Typical Joint Designs and Operating Procedures on pg. I-14 - I-16

CONFORMANCES

AWS A5.10:	ER5356
ABS/AWS:	ER5356
ASME SFA A5.10:	ER5356
Lloyd's Register:	ER5356
DNV-GL:	WB/I-1 S
BV Grade:	5356 I-1
CWB/CSA W48-06:	WB
KR:	ER5356
TUV and DB:	WB G I-1
ISO 18273:	Al 5356 (AlMg5Cr(A)) AlMg5Cr(A)

TYPICAL APPLICATIONS

- Automotive bumpers and supports
- Structural frames in the shipbuilding industry
- Formed truck panels
- Railing Industry
- Power Industry
- Trailer Manufacturing

DIAMETERS / PACKAGING

Diameter in (mm)	1 lb (0.4 kg) Plastic Spool 20 lb (9.1 kg) Master Carton	16 lb (7.3 kg) Platic Spool	20 lb (9.1 kg) Plastic Spool	60 lb (27.2 kg) Mini-Drum	300 lb (136 kg) Accu-Pak® Box	300 lb (136 kg) Gem-Pak™ Box
0.035 (0.9)	ED030312	ED028385		ED036720 ^(d)	ED033178 ^(a)	ED034722
3/64 (1.2)	ED030314		ED030282	ED036593	ED031826 ^(b)	ED034550
1/16 (1.6)			ED030283	ED036721	ED030985 ^(b)	ED034551

^(a)This part number is Made-To-Order. ^(b)Wire payoff kit K2860-1 sold separately. ^(c)This part number contains glass gems.

WIRE COMPOSITION⁽¹⁾ – As Required per SFA/AWS A5.10

	%Al	%Si	%Fe	%Cu	%Mn
Requirements - AWS ER5356	Remainder	0.25 max	0.40 max	0.10 max	0.05 - 0.20
Typical Results ⁽²⁾	Remainder	0.05	0.09	0.03	0.12
	%Mg	%Cr	%Zn	%Ti	%Be
Requirements - AWS ER5356	4.50 - 5.50	0.05 - 0.20	0.10 max	0.06 - 0.20	0.0003 max
Typical Results ⁽²⁾	4.90	0.08	< 0.01	0.15	0.0002

⁽¹⁾Typical all weld metal. ⁽²⁾See test results disclaimer

SUPERGLAZE® HD 5356

Aluminum · AWS ER5356

KEY FEATURES

- Designed for heavy duty applications
- Reduced shavings and improved feedability
- General purpose filler alloy for welding 5XXX series alloys

WELDING POSITIONS

All

SHIELDING GAS

100% Argon
Argon / Helium Mixtures
Flow Rate: 30 - 50 CFH for Argon

NOTE

- Typical Joint Designs and Operating Procedures on pg. I-14 - I-16

CONFORMANCES

AWS A5.10: ER5356
ISO 1B273: AlMg5Cr(A)

TYPICAL APPLICATIONS

- Ideal for aggressive work environments and applications with long conduit lengths
- Automotive bumpers and supports
- Structural frames in the shipbuilding industry
- Formed truck panels
- Railcars
- Power industry
- Trailer manufacturing

DIAMETERS / PACKAGING

Diameter in (mm)	16 lb (7.3 kg) Steel Spool	20 lb (9.1 kg) Plastic Spool	60 lb (27.2 kg) Mini-Drum	300 lb (136 kg) Gem-Pak™ Box
0.035 (0.9)	ED035672	ED035673		ED036335
3/64 (1.2)	ED035674	ED035675	ED036595	ED036336
1/16 (1.6)	ED035676	ED035677		ED036337

WIRE COMPOSITION⁽¹⁾ – As Required per AWS A5.10

	%Al	%Si	%Fe	%Cu	%Mn
Requirements - AWS ER5356	Remainder	0.25 max	0.40 max	0.10 max	0.05-0.20
Typical Results⁽²⁾	Remainder	0.05	0.09	0.03	0.12
	%Mg	%Cr	%Zn	%Ti	%Be
Requirements - AWS ER5356	4.5-5.5	0.05-0.20	0.10 max	0.06-0.20	0.0003 max
Typical Results⁽²⁾	4.9	0.08	<0.01	0.15	0.0002

⁽¹⁾Typical wire chemistry. ⁽²⁾See test results disclaimer

SUPERGLAZE® 5356 TM™

Aluminum · AWS ER5356

KEY FEATURES

- Unparalleled bead profile and appearance which are critical for groove and fillet welds on aluminum trailer beds.
- SuperGlaze® 5356 TM™ has an engineered chemical composition developed specifically to outperform standard ER5356 electrodes and gives the operator unprecedented control.
- Proprietary manufacturing processes give SuperGlaze® 5356 TM™ the smoothest surface finish in the industry, making it ideal for automatic applications on formed truck panels.

WELDING POSITIONS

All, except vertical down

NOTE

- Typical Joint Designs and Operating Procedures on pg. I-14 - I-16

CONFORMANCES

AWS A5.10:	ER5356
ASME SFA-5.10:	ER5356
CWB/CSA W48-06:	ER5356
ISO 18273:	AlMg5Cr(A)
TUV and DB:	AlMg5Cr(A)

TYPICAL APPLICATIONS

- High speed groove welds on formed truck panels
- Multi-pass fillet and lap welds on 6XXX series base materials
- Robotic fillet welds on trailer tanks requiring minimal post-weld clean up

SHIELDING GAS

100% Argon
Argon / Helium Mixtures
Flow Rate: 30 - 50 CFH

DIAMETERS / PACKAGING

Diameter in (mm)	1 lb (0.4 kg) Plastic Spool 20 lb (9.1 kg) Master Carton	16 lb (7.3 kg) Steel Spool	20 lb (9.1 kg) Plastic Spool	60 lb (27.2 kg) Mini-Drum	300 lb (136 kg) Gem-Pak™
0.035 (0.9)	ED034064	ED034067			ED034723
3/64 (1.2)	ED034065	ED034068	ED034070	ED036594	ED034724
1/16 (1.6)	ED034066	ED034069	ED034071		ED034729

WIRE COMPOSITION⁽¹⁾ – As Required per SFA/AWS A5.10

	%Al	%Si	%Fe	%Cu	%Mn
Requirements - AWS ER5356	Remainder	0.25 max	0.40 max	0.10 max	0.05 - 0.20
Typical Results⁽²⁾	Remainder	0.065	0.15	0.0035	0.125
	%Mg	%Cr	%Zn	%Ti	%Be
Requirements - AWS ER5356	4.50 - 5.50	0.05 - 0.20	0.10 max	0.06 - 0.20	0.0003 max
Typical Results⁽²⁾	4.565	0.11	0.0075	0.085	0.0002

⁽¹⁾Typical all weld metal. ⁽²⁾See test results disclaimer

SUPERGLAZE® HD 5356 TM™

Aluminum · AWS ER5356

KEY FEATURES

- Designed for heavy duty applications
- Reduced shavings and improved feedability
- High speed groove welds on formed truck panels
- Multi-pass fillet and lap welds on 6XXX series base materials
- Robotic fillet welds on trailer tanks requiring minimal post-weld clean up

WELDING POSITIONS

All

NOTE

- Typical Joint Designs and Operating Procedures on pg. I-14 - I-16

CONFORMANCES

AWS A5.10:	ER5356
ASME SFA-5.10:	ER5356
CWB/CSA W48-06:	ER5356
ISO 18273:	AlMg5Cr(A)
TUV and DB:	AlMg5Cr(A)

TYPICAL APPLICATIONS

- Ideal for aggressive work environments and applications with long conduit lengths
- Trailer manufacturing

SHIELDING GAS

100% Argon
 Argon / Helium Mixtures
 Flow Rate: 30 - 50 CFH for Argon

DIAMETERS / PACKAGING

Diameter in (mm)	16 lb (7.3 kg) Steel Spool	20 lb (9.1 kg) Plastic Spool	60 lb (27.2 kg) Mini-Drum	300 lb (136 kg) Gem-Pak™ Box
0.035 (0.9)				ED036338
3/64 (1.2)	ED035698	ED035699	ED036596	ED036339
1/16 (1.6)	ED035700	ED035701		ED036340

WIRE COMPOSITION⁽¹⁾ – As Required per AWS A5.10

	%Al	%Si	%Fe	%Cu	%Mn
Requirements - AWS ER5356	Remainder	0.25 max	0.40 max	0.10 max	0.05-0.20
	%Mg	%Cr	%Zn	%Ti	%Be
Requirements - AWS ER5356	4.5-5.5	0.05-0.20	0.10 max	0.06-0.20	0.0003 max

⁽¹⁾Typical wire chemistry.

SUPERGLAZE® 5554

Aluminum · AWS ER5554

KEY FEATURES

- Matching filler alloy for welding 5454 base alloys
- Low magnesium content to closely match the base material chemistry
- Suitable for sustained elevated temperature service, i.e. above 65°C (150°F)

WELDING POSITIONS

All, except vertical down

NOTE

- Typical Joint Designs and Operating Procedures on pg. I-14 - I-16

CONFORMANCES

AWS A5.10:	ER5554
ASME SFA 5.10:	ER5554
CWB/CSA W48-06:	ER5554

TYPICAL APPLICATIONS

- 5454 base alloys
- Automotive wheels
- Transportation applications such as over-the-road trailers and rail tank cars
- Chemical storage tanks

SHIELDING GAS

100% Argon
Argon / Helium Mixtures
Flow Rate: 30 - 50 CFH

DIAMETERS / PACKAGING

Diameter in (mm)	16 lb (7.3 kg) Plastic Spool	300 lb (136 kg) Gem-Pak™ Box
3/64 (1.2)	ED029573	ED034725
1/16 (1.6)		ED034730

WIRE COMPOSITION⁽¹⁾ – As Required per SFA/AWS A5.10

	%Al	%Si	%Fe	%Cu	%Mn
Requirements - AWS ER5554	Remainder	0.25 max	0.40 max	0.10 max	0.50 - 1.00
Typical Results⁽²⁾	Remainder	0.06	0.13	0.03	0.51
	%Mg	%Cr	%Zn	%Ti	%Be
Requirements - AWS ER5554	2.40 - 3.00	0.05 - 0.20	0.25 max	0.05 - 0.20	0.0003 max
Typical Results⁽²⁾	2.41	0.06	< 0.01	0.09	0.0001

⁽¹⁾Typical all weld metal. ⁽²⁾See test results disclaimer

SUPERGLAZE® 5556

Aluminum · AWS ER5556

KEY FEATURES

- Provide higher tensile strengths for welding of higher strength 5XXX alloys, such as 5456
- Increased amounts of magnesium and manganese

WELDING POSITIONS

All, except vertical down

NOTE

- Typical Joint Designs and Operating Procedures on pg. I-14 - I-16

CONFORMANCES

AWS A5.10:

ASME SFA A5.10:

ABS/AWS:

ISO 18273:

ER5556

ER5556

ER5356 Ar

AlMg5Mn1Ti(A)

TYPICAL APPLICATIONS

- 5XXX alloys, such as 5083 and 5456
- Pressure vessels
- Storage tanks
- Military

SHIELDING GAS

100% Argon

Argon / Helium Mixtures

Flow Rate: 30 - 50 CFH

DIAMETERS / PACKAGING

Diameter in (mm)	1 lb (0.4 kg) Plastic Spool 20 lb (9.1 kg) Master Carton	16 lb (7.3 kg) Plastic Spool	300 lb (136 kg) Gem-Pak™ Box
3/64 (1.2)	EDS30329	EDS29581	ED034767
1/16 (1.6)		EDS29582	ED034731
3/32 (2.4)		ED034175	

WIRE COMPOSITION⁽¹⁾ – As Required per SFA/AWS A5.10

	%Al	%Si	%Fe	%Cu	%Mn
Requirements - AWS ER5556	Remainder	0.25 max	0.40 max	0.10 max	0.50 - 1.00
Typical Results⁽²⁾	Remainder	0.03	0.13	0.001	0.65
	%Mg	%Cr	%Zn	%Ti	%Be
Requirements - AWS ER5556	4.70 - 5.50	0.05 - 0.20	0.25 max	0.05 - 0.20	0.0003 max
Typical Results⁽²⁾	5.00	0.10	0.02	0.07	0.0002

⁽¹⁾Typical all weld metal. ⁽²⁾See test results disclaimer

SUPERGLAZE® HD 5556

Aluminum · AWS ER5556

KEY FEATURES

- Designed for heavy duty applications
- Reduced shavings and improved feedability
- Provide higher tensile strengths for welding 5XXX series alloys
- Increased amounts of magnesium and manganese

WELDING POSITIONS

All

NOTE

- Typical Joint Designs and Operating Procedures on pg. I-14 - I-16

CONFORMANCES

AWS A5.10: AlMg5Mn1Ti(A)

ISO 18273:
ER5556

TYPICAL APPLICATIONS

- Ideal for aggressive work environments and applications with long conduit lengths
- Pressure vessels
- Storage tanks

SHIELDING GAS

100% Argon
Argon / Helium Mixtures
Flow Rate: 30 - 50 CFH for Argon

DIAMETERS / PACKAGING

Diameter in (mm)	16 lb (7.3 kg) Steel Spool	20 lb (9.1 kg) Plastic Spool	300 lb (136 kg) Gem-Pak™ Box
0.035 (0.9)			ED036380
3/64 (1.2)	ED035680	ED035681	ED036381
1/16 (1.6)			ED036382

WIRE COMPOSITION⁽¹⁾ – As Required per AWS A5.10

	%Al	%Si	%Fe	%Cu	%Mn
Requirements - AWS ER5556	Remainder	0.25 max	0.40 max	0.10 max	0.50 - 1.0
Typical Results ⁽²⁾	Remainder	0.03	0.13	0.001	0.65
	%Mg	%Cr	%Zn	%Ti	%Be
Requirements - AWS ER5556	4.7 - 5.5	0.05 - 0.20	0.25 max	0.05 - 0.20	0.0003 max
Typical Results ⁽²⁾	5.0	0.10	0.02	0.07	0.0002

⁽¹⁾Typical wire chemistry. ⁽²⁾See test results disclaimer

SUPERGLAZE® 4043

Aluminum · AWS ER4043

KEY FEATURES

- Use on many weldable cast and wrought aluminum alloys
- Generally recommended for welding 5052, any 6XXX series alloys and castings
- Embossed on each end for easy identification after use

WELDING POSITIONS

All

NOTE

- Typical Joint Designs and Operating Procedures on pg. I-14 - I-16

CONFORMANCES

AWS A5.10:	ER4043
ASME SFA-5.10:	ER4043
ISO 18273:	AlSi5
DB and TUV:	AlSi5

TYPICAL APPLICATIONS

- Bicycle frames
- Pressure vessels

DIAMETERS / PACKAGING

Diameter in (mm)	10 lb (4.5 kg) Carton
1/16 (1.6)	ED031111
3/32 (2.4)	ED031112
1/8 (3.2)	ED031113

WIRE COMPOSITION⁽¹⁾ – As Required per SFA/AWS A5.10

	%Al	%Si	%Fe	%Cu	%Mn
Requirements - AWS ER4043	Remainder	4.50-6.00	0.80 max	0.30 max	0.05 max
Typical Results ⁽²⁾	Remainder	5.01	0.13	0.008	0.009
	%Mg	%Cr	%Zn	%Ti	%Be
Requirements - AWS ER4043	0.05 max	Not Specified	0.10 max	0.20 max	0.0003 max
Typical Results ⁽²⁾	0.03	—	0.002	0.007	0.0002

⁽¹⁾Typical all weld metal. ⁽²⁾See test results disclaimer

SUPERGLAZE® 5356

Aluminum · AWS ER5356

KEY FEATURES

- Aluminum-magnesium alloy for use on many weldable cast and wrought aluminum alloys
- Generally recommended for welding any 5XXX or 6XXX series aluminum alloys
- Excellent for color matching after anodizing
- Embossed on each end for easy identification after use

WELDING POSITIONS

All

DIAMETERS / PACKAGING

Diameter in (mm)	10 lb (4.5 kg) Carton
1/16 (1.6)	ED031108
3/32 (2.4)	ED031109
1/8 (3.2)	ED031110

WIRE COMPOSITION⁽¹⁾ – As Required per SFA/AWS A5.10

	%Al	%Si	%Fe	%Cu	%Mn	%Mg	%Cr	%Zn	%Ti	%Be
Requirements - AWS ER5356	Remainder	0.25 max	0.40 max	0.10 max	0.05-0.20	4.05-5.5	0.05-0.20	0.10 max	0.06-0.20	0.0003 max
Typical Results ⁽²⁾	Remainder	0.06	0.09	0.02	0.12	4.84	0.12	0.001	0.09	0.0002

⁽¹⁾Typical all weld metal. ⁽²⁾See test results disclaimer

STICK (SMAW) ELECTRODE

FERROWELD®

Cast Iron · AWS ESt

KEY FEATURES

- Deposits may be finished by grinding
- Cost effective option for repairing cast iron

WELDING POSITIONS

All

DIAMETERS / PACKAGING

Diameter in (mm)	1 lb (0.5 kg) Plastic Tube 6 lb (2.7 kg) Master Carton	10 lb (4.5 kg) Easy Open Can 30 lb (13.6 kg) Master Carton
1/8 (3.2)	ED031542	ED033882

TYPICAL OPERATING PROCEDURES

Electrode	Electrode Polarity	Current (Amps)
Ferroweld®	DC+/AC	80 - 120

CONFORMANCES

AWS A5.10:	ER5356
ASME SFA-5.10:	ER5356
ABS/AWS:	ER5356 Ar
ISO 18273:	AlMg5Cr(A)

TYPICAL APPLICATIONS

- Architectural structures
- Gun mount bases
- Armored vehicles

NOTE

- Typical Joint Designs and Operating Procedures on pg. I-14 - I-16

TYPICAL JOINT DESIGNS

Aluminum MIG Welding

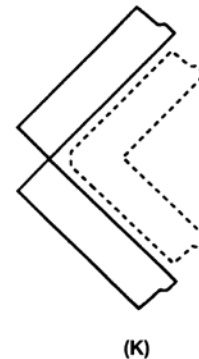
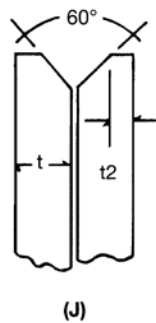
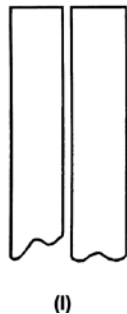
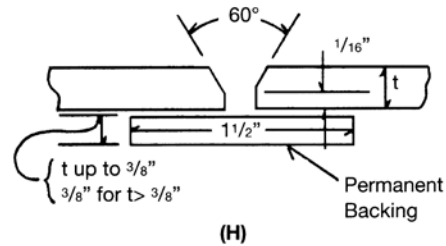
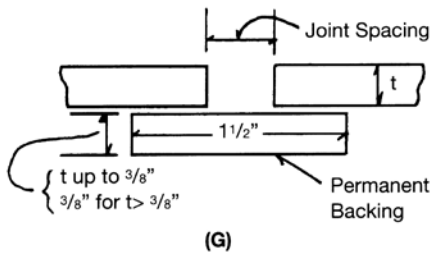
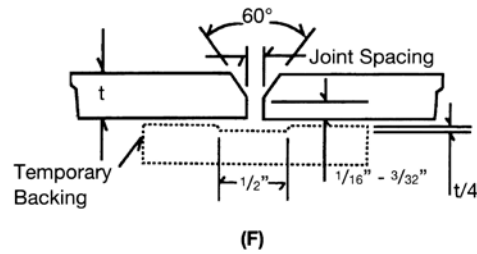
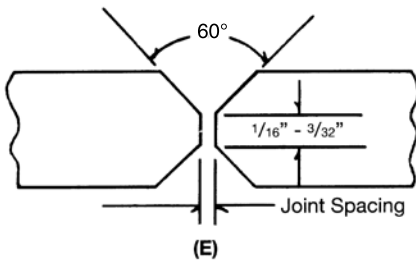
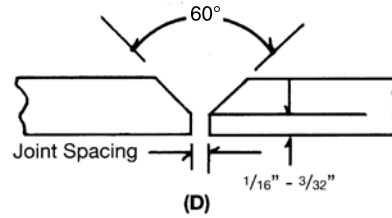
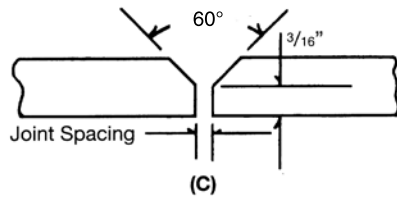
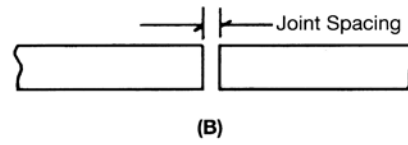
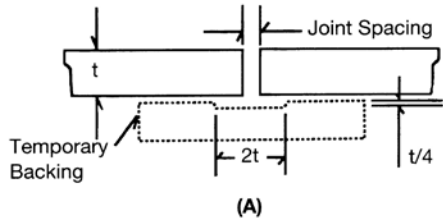

TYPICAL OPERATING PROCEDURES

Aluminum MIG Welding

TYPICAL OPERATING PROCEDURES FOR GROOVE WELDING

Metal Thickness (in)	Weld Position ^(a)	Edge Preparation ^(b)	Joint Spacing (in)	Weld Passes	Electrode Diameter (in)
1/16	F	A	None	1	0.030
	F	G	3/32	1	0.030
1/8	F, V, H	A	0 - 3/32	1	0.030 - 3/64
	F, V, H, O	G	3/16	1	0.030 - 3/64
3/16	F, V, H	B	0 - 1/16	1F, 1R	0.030 - 3/64
	F, V, H	F	0 - 1/16	1	3/64
	O	F	0 - 1/16	2F	3/64
	F, V	H	3/32 - 3/16	2	3/64 - 1/16
	H, O	H	3/16	3	3/64
1/4	F	C-90°	0 - 3/32	1F, 1R	3/64 - 1/16
	F	F	0 - 3/32	2	3/64 - 1/16
	V, H	F	0 - 3/32	3F, 1R	3/64
	O	F	0 - 3/32	3F, 1R	3/64 - 1/16
	F, V	H	1/8 - 1/4	2 - 3	3/64 - 1/16
	O, H	H	1/4	4 - 6	3/64 - 1/16
3/8	F	C-90°	0 - 3/32	1F, 1R	1/16
	F	F	0 - 3/32	2F, 1R	1/16
	V, H	F	0 - 3/32	3F, 1R	1/16
	O	F	0 - 3/32	5F, 1R	1/16
	F, V	H	1/4 - 3/8	4	1/16
	O, H	H	3/8	8 - 10	1/16
3/4	F	C-60°	0 - 3/32	3F, 1R	3/32
	F	F	0 - 1/8	4F, 1R	3/32
	V, H, O	F	0 - 1/16	8F, 1R	1/16
	F	E	0 - 1/16	3F, 3R	1/16
	V, H, O	E	0 - 1/16	6F, 6R	1/16

TYPICAL OPERATING PROCEDURES FOR GROOVE WELDING

Metal Thickness ^(d) (in)	Weld Position ^(a)	Weld Passes ^(b)	Electrode Diameter (in)	DC+ Current ^(e) (Amps)
1/8	F,	1	0.030 - 3/64	125 - 150
	V, H	1	0.030	110 - 130
	O	1	0.030 - 3/64	115 - 140
3/16	F	1	3/64	180 - 210
	V, H	1	0.030 - 3/64	130 - 175
	O	1	0.030 - 3/64	130 - 190
1/4	F	1	3/64 - 1/16	170 - 240
	V, H	1	3/64	170 - 210
	O	1	3/64 - 1/16	190 - 220
3/8	F	1	1/16	240 - 300
	V, H	3	1/16	190 - 240
	O	3	1/16	200 - 240
3/4	F	4	3/32	360 - 380
	V, H	4-6	1/16	260 - 310
	O	10	1/16	275 - 310

^(a)F - Flat, V - Vertical, H - Horizontal, O - Overhead. ^(b)See joint designs on page 322. ^(c)For 5XXX series wires, use a welding current on the high side of the range and an arc voltage in the lower portion of the range. For 1XXX, and 4XXX series wires, use the lower currents and higher arc voltages. ^(d)Metal thickness of 3/4 in or greater for fillet welds sometimes employs a double vee bevel of 50° or greater included vee with 3/32 in to 1/8 in land thickness on the abutting member. ^(e)Number of weld passes and electrode consumption given for weld on one side only.

TYPICAL OPERATING PROCEDURES

Aluminum MIG Welding

DC+ Current ^(a) (Amps)	Arc Voltage ^(b) (Volts)	Argon Gas Flow (cfh)	Arc Travel Speed (ipm/pass)	Approx. Electrode Consump. (lb/100 ft)
70 - 110	15 - 20	25	25 - 45	1.5
70 - 110	15 - 20	25	25 - 45	2
120 - 150	20 - 24	30	24 - 30	2
110 - 135	19 - 23	30	18 - 28	3
130 - 175	22 - 26	35	24 - 30	4
140 - 180	23 - 27	35	24 - 30	5
140 - 175	23 - 27	60	24 - 30	5
140 - 185	23 - 27	35	24 - 30	8
130 - 175	23 - 27	60	25 - 35	10
175 - 200	24 - 28	40	24 - 30	6
185 - 225	24 - 29	40	24 - 30	8
165 - 190	25 - 29	45	25 - 35	10
180 - 200	25 - 29	60	25 - 35	10
175 - 225	25 - 29	40	24 - 30	12
170 - 200	25 - 29	60	25 - 40	12
225 - 290	26 - 29	50	20 - 30	16
210 - 275	26 - 29	50	24 - 35	18
190 - 220	26 - 29	55	24 - 30	20
200 - 250	26 - 29	60	25 - 40	20
210 - 290	26 - 29	50	24 - 30	35
190 - 260	26 - 29	60	25 - 40	50
340 - 400	26 - 31	80	14 - 20	50
325 - 375	26 - 31	80	16 - 20	70
240 - 300	26 - 30	60	24 - 30	75
270 - 330	26 - 30	60	16 - 24	70
230 - 280	26 - 30	80	16 - 24	75

Arc Voltage ^(b) (Volts)	Argon Gas Flow (cfh)	Arc Travel Speed (ipm/pass)	Approx. Electrode Consump. ^(a) (lb/100 ft)
20 - 24	30	24 - 30	2
19 - 23	30	24 - 30	2
20 - 24	40	24 - 30	2
22 - 26	30	24 - 30	4.5
21 - 25	35	24 - 30	4.5
22 - 26	45	24 - 30	4.5
24 - 28	40	24 - 30	7
23 - 27	45	24 - 30	7
24 - 28	60	24 - 30	7
26 - 29	50	18 - 25	17
24 - 27	60	24 - 30	17
25 - 28	60	24 - 30	17
26 - 30	80	18 - 25	66
25 - 20	60	24 - 30	66
25 - 29	60	24 - 30	66

CONSUMABLES

PIPELINER



PIPELINER® 6P+

Mild Steel, Cellulosic · AWS E6010

KEY FEATURES

- Q2 Lot® - Lot Controlled Chemistry and Mechanical Properties
- Meets NACE MR0175 for sour gas applications
- Test data available for SSC (NACE TM0177) & HIC (NACE TM0284)

TYPICAL APPLICATIONS

- Cross country and in-plant pipe welding
- Root pass on up to X80 grade pipe
- Hot, fill and cap pass on up to X60 grade pipe

CONFORMANCES

AWS A5.1:	E6010
ABS:	E6010
CWB/CSA:	E4310
DNV-GL:	3
ISO 2560-A:	E 42 3 C 2 1

WELDING POSITIONS

Designed for vertical down welding

DIAMETERS / PACKAGING

Diameter mm (in)	Length in (mm)	10 lb (4.5 kg) Easy Open Can 30 lb (13.6 kg) Master Carton	50 lb (22.7 kg) Easy Open Can
2.5 (3/32)	12 (300)	ED032609	
3.2 (1/8)	14 (350)	ED032610	ED030848
4.0 (5/32)	14 (350)	ED032611	ED030849

MECHANICAL PROPERTIES⁽¹⁾ – As Required per AWS A5.1

	Yield Strength ⁽²⁾ MPa (ksi)	Tensile Strength MPa (ksi)	Elongation %	Charpy V-Notch J (ft-lbf) @-29°C [-20°F]
Requirements - AWS E6010	330 (48) min	430 (60) min	22 min.	27 (20) min
Typical Results ⁽³⁾ - As-Welded	405-515 (59-75)	495-620 (72-90)	22-36	27-85 (20-63)

DEPOSIT COMPOSITION⁽¹⁾ – As Required per AWS A5.1

	%C	%Mn	%Si	%P	%S
Requirements - AWS E6010	0.20 max	1.20 max	1.00 max	Not Specified	Not Specified
Typical Results ⁽³⁾ - As-Welded	0.11-0.20	0.51-0.77	0.15-0.32	0.006-0.016	0.005-0.011
	%Ni	%Cr	%Mo	%V	
Requirements - AWS E6010	0.30 max	0.20 max	0.30 max	0.08 max.	
Typical Results ⁽³⁾ - As-Welded	0.01-0.04	0.01-0.04	0.01-0.02	≤ 0.01	

TYPICAL OPERATING PROCEDURES

Polarity ⁽⁴⁾	Current (Amps)		
	2.5 mm (3/32 in)	3.2 mm (1/8 in)	4.0 mm (5/32 in)
DC+	50-85	75-135	100-175
DC-	50-85	75-135	100-175

⁽¹⁾Typical all weld metal. ⁽²⁾Measured with 0.2% offset. ⁽³⁾See test results disclaimer ⁽⁴⁾Preferred polarity is listed first.

PIPELINER® 16P

Mild Steel, Low Hydrogen · AWS E7016-1 H4

KEY FEATURES

- Q2 Lot® - Lot Controlled Chemistry and Mechanical Properties

TYPICAL APPLICATIONS

- Root pass welding of up to X100 grade pipe
- Hot, fill and cap pass welding up to X60
- Low hydrogen, vertical up capability on X60 grade pipe

CONFORMANCES

AWS A5.1:	E7016-1 H4, E7016-H4
ABS:	E7016-H4
CWB/CSA:	E4916-H4

WELDING POSITIONS

All but vertical-up

DIAMETERS / PACKAGING

Diameter mm [in]	Length in (mm)	10 lb (4.5 kg) Easy Open Can 30 lb (13.6 kg) Master Carton
2.5 [3/32]	14 [350]	ED033835
3.2 [1/8]	14 [350]	ED033836
4.0 [5/32]	18 [450]	ED033837

MECHANICAL PROPERTIES⁽¹⁾ – As Required per AWS A5.1

	Yield Strength ⁽²⁾ MPa (ksi)	Tensile Strength MPa (ksi)	Elongation %	Charpy V-Notch J (ft-lbf)	
				@ -46°C [-50°F]	@ -40°C [-40°F]
Requirements - AWS E7016-1 H4	400 [58] min	490 [70] min	22 min	27 [20] min	Not Specified
Typical Results ⁽³⁾ - As-Welded	420-470 [61-68]	530-570 [76-83]	30-32	75-125 [55-92]	99-141 [73-104]

DEPOSIT COMPOSITION⁽¹⁾ – As Required per AWS A5.1

	%C	%Mn	%Si	%P	%S	%Ni
Requirements - AWS E7016-1 H4	0.15 max	1.60 max.	0.75 max	0.035 max	0.035 max	0.30 max
Typical Results ⁽³⁾ - As-Welded	0.04-0.08	1.10-1.60	0.39-0.67	0.005-0.020	0.004-0.012	< 0.07
	%Cr	%Mo	%V	%Mn + Ni + Cr + Mo + V	Diffusible Hydrogen (mL/100g weld metal)	
Requirements - AWS E7016-1 H4	0.20 max	0.30 max	0.08 max	1.75 max	4 max	
Typical Results ⁽³⁾ - As-Welded	0.01-0.07	0.01-0.03	0.01-0.02	1.14-1.71	1-4	

TYPICAL OPERATING PROCEDURES

Polarity ⁽⁴⁾	Current (Amps)		
	2.5 mm [3/32 in]	3.2 mm [1/8 in]	4.0 mm [5/32 in]
DC+	55-105	75-135	120-170
AC	60-115	80-150	120-185

⁽¹⁾Typical all weld metal. ⁽²⁾Measured with 0.2% offset. ⁽³⁾See test results disclaimer ⁽⁴⁾Preferred polarity is listed first.

PIPELINER® 7P+

Low Alloy, Cellulosic, Pipe · AWS E7010-P1

KEY FEATURES

- Q2 Lot® - Lot Controlled Chemistry and Mechanical Properties
- Meets NACE MR0175 for sour gas applications
- Test data available for SSC (NACE TM0177) & HIC (NACE TM0284)

CONFORMANCES

AWS A5.5: E7010-P1, E7010-G
ABS: E7010-P1
ISO 2560-A: E 46 3 1Ni C 2 1

WELDING POSITIONS

Designed for vertical down welding of cross-country and in-plant pipe

TYPICAL APPLICATIONS

- Root pass welding of up to X80 grade pipe
- Hot, fill and cap pass of up to X65 grade pipe

DIAMETERS / PACKAGING

Diameter mm (in)	Length mm (in)	10 lb (4.5 kg) Easy-Open Can 30 lb (13.6 kg) Master Carton	50 lb (22.7 kg) Easy Open Can
3.2 (1/8)	350 (14)	ED032612	ED031611
4.0 (5/32)	350 (14)	ED032613	ED031612
5.0 (3/16)	350 (14)	ED032614	ED031613

MECHANICAL PROPERTIES⁽¹⁾ – As Required per AWS A5.5

	Yield Strength ⁽²⁾ MPa (ksi)	Tensile Strength MPa (ksi)	Elongation %	Charpy V-Notch J (ft-lbf)	
				@ -29°C (-20°F)	@ -40°C (-40°F)
Requirements - AWS E7010-P1	415 (60) min	490 (70) min	22 min	27 (20) min	Not Specified
Typical Results⁽³⁾ - As-Welded	455-515 (66-75)	525-635 (76-92)	23-29	49-92 (36-68)	31-85 (23-63)

DEPOSIT COMPOSITION⁽¹⁾ – As Required per AWS A5.5

	%C	%Mn	%Si	%P	%S
Requirements - AWS E7010-P1	0.20 max	1.20 max	0.60 max	0.03 max	0.03 max
Typical Results⁽³⁾ - As-Welded	0.09-0.20	0.44-0.83	0.06-0.31	0.01-0.02	0.01-0.02
	%Ni	%Cr	%Mo	%V	
Requirements - AWS E7010-P1	1.00 max	0.30 max	0.50 max	0.10 max	
Typical Results⁽³⁾ - As-Welded	0.58-0.90	0.02-0.05	0.04-0.21	≤ 0.01	

TYPICAL OPERATING PROCEDURES

Polarity	Current (Amps)		
	3.2 mm (1/8 in)	4.0 mm (5/32 in)	5.0 mm (3/16 in)
DC+	65-130	100-165	130-210

⁽¹⁾Typical all weld metal. ⁽²⁾Measured with 0.2% offset. ⁽³⁾See test results disclaimer
 NOTE: This product contains micro-alloying elements. Additional information available upon request.

PIPELINER® 8P+

Low Alloy, Cellulosic, Pipe · AWS E8010-P1

KEY FEATURES

- Q2 Lot® - Lot Controlled Chemistry and Mechanical Properties
- Meets NACE MR0175 for sour gas applications
- Test data available for SSC (NACE TM0177) & HIC (NACE TM0284)

CONFORMANCES

AWS A5.5:	E8010-P1, E8010-G
ABS:	E8010-P1
CWB/CSA:	E5510-P1
ISO 2560-B:	E5510-P1 A U

TYPICAL APPLICATIONS

- Root pass welding of up to X80 grade pipe
- Hot, fill and cap pass of up to X70 grade pipe

WELDING POSITIONS

Designed for vertical down welding of cross-country and in-plant pipe

DIAMETERS / PACKAGING

Diameter mm (in)	Length mm (in)	10 lb (4.5 kg) Easy-Open Can 30 lb (13.6 kg) Master Carton	50 lb (22.7 kg) Easy Open Can
3.2 (1/8)	350 (14)	ED032615	ED030826
4.0 (5/32)	350 (14)	ED032616	ED030827
5.0 (3/16)	350 (14)	ED032617	ED030828

MECHANICAL PROPERTIES⁽¹⁾ – As Required per AWS A5.5

	Yield Strength ⁽²⁾ MPa (ksi)	Tensile Strength MPa (ksi)	Elongation %	Charpy V-Notch J (ft-lbf)	
				@ -29°C (-20°F)	@ -40°C (-40°F)
Requirements - AWS E8010-P1	460 (67) min	550 (80) min	19 min	27 (20) min	Not Specified
Typical Results⁽³⁾ - As-Welded	475-545 (69-79)	560-670 (81-97)	20-32	49-149 (36-110)	41-119 (30-88)

DEPOSIT COMPOSITION⁽¹⁾ – As Required per AWS A5.5

	%C	%Mn	%Si	%P	%S
Requirements - AWS E8010-P1	0.20 max	1.20 max	0.60 max	0.03 max	0.03 max
Typical Results⁽³⁾	0.09-0.20	0.55-0.98	0.07-0.27	0.01-0.02	0.01-0.02
	%Ni	%Cr	%Mo	%V	
Requirements - AWS E8010-P1	1.00 max	0.30 max	0.50 max	0.10 max	
Typical Results⁽³⁾	0.73-1.00	0.02-0.05	0.13-0.22	0.01 max.	

TYPICAL OPERATING PROCEDURES

Polarity	Current (Amps)		
	3.2 mm (1/8 in)	4.0 mm (5/32 in)	5.0 mm (3/16 in)
DC+	65-120	100-165	130-210

⁽¹⁾Typical all weld metal. ⁽²⁾Measured with 0.2% offset. ⁽³⁾See test results disclaimer
NOTE: This product contains micro-alloying elements. Additional information available on request.

PIPELINER® ARC 80

Low Alloy, Cellulosic, Pipe · AWS E8010-P1

KEY FEATURES

- Q2 Lot® Control and Tested – Lot Certificate available online.
- Meets NACE MR0175 for sour gas applications
- Test data available for SSC (NACE TM0177) & HIC (NACE TM0284)
- Excellent impact properties without the intentional addition of Boron

CONFORMANCES

- AWS A5.5:** E8010-P1, E8010-G
CWB/CSA: E8010-P1
ISO 2560-B: E5510-P1 A U

WELDING POSITIONS

Designed for vertical down welding of cross-country and in-plant pipe.

TYPICAL APPLICATIONS

- Root pass welding of up to X80 grade pipe
- Hot, fill and cap pass welding on up to X70 grade pipe

DIAMETERS / PACKAGING

Diameter	Length in (mm)	50 lb. (22.7 kg) Easy Open Can
4.0 mm (5/32 in)	14 (350)	ED034456
3/16 in ^(a)	14 (350)	ED034458
5.0 mm	14 (350)	ED034457

MECHANICAL PROPERTIES⁽¹⁾ – As Required per AWS A5.5

	Yield Strength ⁽²⁾ MPa (ksi)	Tensile Strength MPa (ksi)	Elongation %	Charpy V-Notch J (ft-lbf)	
				@ 29°C (20°F)	@ -40°C (-40°F)
Requirements AWS E8010 P1	460 (67) min	550 (80) min	19 min	27 (20) min	Not Specified
Typical Results⁽³⁾ As-Welded	475-545 (69-79)	560 670 (81-97)	19-32	49-149 (36-110)	41-119 (30-88)

DEPOSIT COMPOSITION⁽¹⁾ – As Required per AWS A5.5

	%C	%Mn	%Si	%P	%S
Requirements AWS E8010 P1	0.20 max	1.20 max	0.60 max	0.30 max	0.03 max
Typical Results⁽³⁾	0.09-0.20	0.55-0.98	0.07-0.27	0.01-0.02	0.01-0.02
	%Ni	%Cr	%Mo	%V	
Requirements AWS E8010 P1	1.00 max	0.30 max	0.50 max	0.10 max	
Typical Results⁽³⁾	0.73-1.00	0.02-0.05	0.13-0.22	0.01 max	

TYPICAL OPERATING PROCEDURES

Polarity ⁽⁴⁾	Current (Amps)		
	4.0 mm (5/32 in)	3/16 in ^(a)	5.0 mm
DC+	100-165	125-205	130-210

⁽¹⁾ Typical all weld metal. ⁽²⁾ Measured with 0.2% offset. ⁽³⁾ See test results disclaimer ⁽⁴⁾ Preferred polarity is listed first. ^(a) Manufactured to US standard units.

PIPELINER® LH-D80

Low Alloy, Low Hydrogen, Pipe · AWS E8045-P2 H4R

KEY FEATURES

- Q2 Lot® - Control and Tested - Lot certificate available online
- NACE MR0175 compliant for sour gas applications
- 80% higher productivity over traditional vertical-up pipe welding

TYPICAL APPLICATIONS

- Fill and cap pass welding on up to X70 grade pipe
- Pipe repair
- Hot tapping

CONFORMANCES

AWS A5.5:	E8045-P2 H4R
ABS:	E8045-P2 H4R
CWB/CSA:	E5545-P2-H4R

WELDING POSITIONS

Vertical Down

DIAMETERS / PACKAGING

Diameter mm (in)	Length mm (in)	10 lb (4.5 kg) Easy Open Can 30 lb (13.6 kg) Master Carton
3.2 (1/8)	350 (14)	ED032626
4.0 (5/32)	350 (14)	ED032627
4.5 (11/64)	350 (14)	ED032628

MECHANICAL PROPERTIES⁽¹⁾ – As Required per AWS A5.5

	Yield Strength ⁽²⁾ MPa (ksi)	Tensile Strength MPa (ksi)	Elongation %	Charpy V-Notch J (ft-lbf)	
				@ -29°C (-20°F)	@ -46°C (-50°F)
Requirements - AWS E8045-P2 H4R	460 (67) min	550 (80) min	19 min	27 (20) min	Not Specified
Typical Results⁽³⁾ - As-Welded	485-515 (70-75)	570-600 (83-87)	26-31	75-125 (55-92)	50-95 (37-70)

DEPOSIT COMPOSITION⁽¹⁾ – As Required per AWS A5.5

	%C	%Mn	%Si	%P	%S
Requirements - AWS E8045-P2 H4R	0.12 max	0.90-1.70	0.80 max	0.03 max	0.03 max
Typical Results⁽³⁾ - As-Welded	0.04-0.06	1.10-1.25	0.35-0.50	≤ 0.01	≤ 0.01
	%Ni	%Cr	%Mo	%V	Diffusible Hydrogen (mL/100g weld deposit)
Requirements - AWS E8045-P2 H4R	1.00 max	0.20 max	0.50 max	0.05 max	4 max
Typical Results⁽³⁾ - As-Welded	≤ 0.04	≤ 0.05	≤ 0.02	≤ 0.01	2-4

TYPICAL OPERATING PROCEDURES

Polarity	Current (Amps)		
	3.2 mm (1/8 in)	4.0 mm (5/32 in)	4.5 mm (11/64 in)
DC+	120-170	170-250	200-300

⁽¹⁾Typical all weld metal. ⁽²⁾Measured with 0.2% offset. ⁽³⁾See test results disclaimer
NOTE: This product contains micro-alloying elements. Additional information available on request.

PIPELINER® LH-D90

Low Alloy, Low Hydrogen, Pipe · AWS E9045-P2 H4R

KEY FEATURES

- Q2 Lot® - Certificates showing actual deposit chemistry and mechanical properties available online
- NACE MR0175 compliant for sour gas applications
- 80% higher productivity over traditional vertical-up pipe welding

TYPICAL APPLICATIONS

- Fill and cap pass welding of up to X80 grade pipe
- Pipe repair
- Hot tapping

CONFORMANCES

AWS A5.5:	E9045-P2 H4R
ABS:	E9045-P2 H4R
CWB/CSA:	E6245-P2-H4R

WELDING POSITIONS

Vertical Down

DIAMETERS / PACKAGING

Diameter mm (in)	Length in (mm)	10 lb (4.5 kg) Easy Open Can 30 lb (13.6 kg) Master Carton
3.2 (1/8)	14 (350)	ED032629
4.0 (5/32)	14 (350)	ED032630
4.5 (11/64)	14 (350)	ED032631

MECHANICAL PROPERTIES⁽¹⁾ – As Required per AWS A5.5

	Yield Strength ⁽²⁾ MPa (ksi)	Tensile Strength MPa (ksi)	Elongation %	Charpy V-Notch J (ft-lbf)	
				@ -29°C (-20°F)	@ -46°C (-50°F)
Requirements - AWS E9045-P2 H4R	530 (77) min	620 (90) min	17 min	27 (20) min	Not Specified
Typical Results ⁽³⁾ - As-Welded	550-600 (80-87)	625-670 (91-97)	26-31	75-125 (55-92)	50-95 (37-70)

DEPOSIT COMPOSITION⁽¹⁾ – As Required per AWS A5.5

	%C	%Mn	%Si	%P	%S
Requirements - AWS E9045-P2 H4R	0.12 max	0.90-1.70	0.80 max	0.03 max.	0.03 max
Typical Results ⁽³⁾ - As-Welded	0.04-0.06	1.15-1.35	0.35-0.55	≤ 0.01	≤ 0.01
	%Ni	%Cr	%Mo	%V	Diffusible Hydrogen (mL/100g weld deposit)
Requirements - AWS E9045-P2 H4R	1.00 max	0.20 max	0.50 max	0.05 max	4 max
Typical Results ⁽³⁾ - As-Welded	0.25-0.30 ⁽⁴⁾ / 0.80-1.00 ⁽⁵⁾	≤ 0.05	0.15-0.25	≤ 0.01	2-4

TYPICAL OPERATING PROCEDURES

Polarity	Current (Amps)		
	3.2 mm (1/8 in)	4.0 mm (5/32 in)	4.5 mm (11/64 in)
DC+	120-170	170-250	200-300

⁽¹⁾Typical all weld metal. ⁽²⁾Measured with 0.2% offset. ⁽³⁾See test results disclaimer ⁽⁴⁾Range for 3.2 mm (1/8 in) size only. ⁽⁵⁾Range for 4.0 mm (5/32 in) and 4.5 mm (11/64 in) sizes.
NOTE: This product contains micro-alloying elements. Additional information available on request.

PIPELINER® LH-D100

Low Alloy, Low Hydrogen, Pipe · AWS E10045-P2 H4R

KEY FEATURES

- Q2 Lot® - Control and Tested - Lot certificate available online
- Durable coating
- 80% higher productivity over traditional vertical-up pipe welding

TYPICAL APPLICATIONS

- Fill and cap pass welding of up to X90 grade pipe
- Pipe repair
- Hot tapping

CONFORMANCES

AWS A5.5:	E10045-P2 H4R
CWB/CSA:	E6945-P2-H4R
ABS:	E10045-P2 H4R

WELDING POSITIONS

Vertical Down

DIAMETERS / PACKAGING

Diameter mm (in)	Length in (mm)	10 lb (4.5 kg) Easy Open Can 30 lb (13.6 kg) Master Carton
3.2 (1/8)	14 (350)	ED032632
4.0 (5/32)	14 (350)	ED032633
4.5 (11/64)	14 (350)	ED032634

MECHANICAL PROPERTIES⁽¹⁾ – As Required per AWS A5.5

	Yield Strength ⁽²⁾ MPa (ksi)	Tensile Strength MPa (ksi)	Elongation %	Charpy V-Notch J (ft-lbf)	
				@ -29°C (-20°F)	@ -46°C (-50°F)
Requirements - AWS E10045-P2 H4R	600 (87) min	690 (100) min	16 min	27 (20) min	Not Specified
Typical Results⁽³⁾ - As-Welded	620-690 (90-100)	705-750 (102-109)	21-28	75-110 (55-81)	56-85 (41-63)

DEPOSIT COMPOSITION⁽¹⁾ – As Required per AWS A5.5

	%C	%Mn	%Si	%P	%S
Requirements - AWS E10045-P2 H4R	0.12 max	0.90 - 1.70	0.80 max	0.03 max	0.03 max
Typical Results⁽³⁾ - As-Welded	0.04-0.06	1.25-1.65	0.35-0.55	≤ 0.01	≤ 0.01
	%Ni	%Cr	%Mo	%V	Diffusible Hydrogen (mL/100g weld deposit)
Requirements - AWS E10045-P2 H4R	1.00 max	0.20 max	0.50 max	0.05 max	4 max
Typical Results⁽³⁾ - As-Welded	0.70-1.00	≤ 0.08	0.40-0.50	≤ 0.01	2-4

TYPICAL OPERATING PROCEDURES

Polarity	Current (Amps)		
	3.2 mm (1/8 in)	4.0 mm (5/32 in)	4.5 mm (11/64 in)
DC+	120-170	170-250	200-300

⁽¹⁾Typical all weld metal. ⁽²⁾Measured with 0.2% offset. ⁽³⁾See test results disclaimer
NOTE: This product contains micro-alloying elements. Additional information available on request.

PIPELINER® 19P

Low Alloy, Low Hydrogen, Pipe · AWS E10018-G H4R

KEY FEATURES

- Q2 Lot® - Control and Tested - Lot certificate available online
- Charpy V-Notch impact toughness tested to -46°C [-50°F]

TYPICAL APPLICATIONS

- Fill and cap pass welding of up to X80 grade pipe
- Low hydrogen, vertical up capability on X80 grade pipe

CONFORMANCES

AWS A5.5: E10018-G-H4R

WELDING POSITIONS

All, except vertical down

DIAMETERS / PACKAGING

Diameter mm (in)	Length in (mm)	10 lb (4.5 kg) Easy Open Can 30 lb (13.6 kg) Master Carton
3.2 (1/8)	14 (350)	ED032622
4.0 (5/32)	14 (350)	ED032623

MECHANICAL PROPERTIES⁽¹⁾ – As Required per AWS A5.5

	Yield Strength ⁽²⁾ MPa (ksi)	Tensile Strength MPa (ksi)	Elongation %	Charpy V-Notch J (ft-lbf)	
				@ -29°C [-20°F]	@ -46°C [-50°F]
Requirements - AWS E10018-G H4R	600 (87) min	690 (100) min	15 min	Not Specified	Not Specified
Typical Results⁽³⁾ - As-Welded	660-740 (96-107)	740-825 (107-120)	20-26	91-129 (69-95)	81-111 (60-82)

DEPOSIT COMPOSITION⁽¹⁾ – As Required per AWS A5.5

	%C	%Mn	%Si	%P	%S	%Ni ⁽⁴⁾
Requirements - AWS E10018-G H4R	Not Specified	1.00 min	0.80 min	0.03 max	0.03 max	0.50 min
Typical Results⁽³⁾ - As-Welded	0.03-0.05	1.44-1.78	0.34-0.57	0.01-0.02	≤ 0.01	1.92-2.36
	%Cr ⁽⁴⁾	%Mo ⁽⁴⁾	%V ⁽⁴⁾	%Cu ⁽⁴⁾	Diffusible Hydrogen (mL/100g weld deposit)	
Requirements - AWS E10018-G H4R	0.30 min	0.20 min	0.10 min	0.20 min	4 max	
Typical Results⁽³⁾ - As-Welded	0.02-0.07	0.37-0.47	0.01-0.02	0.01-0.07	2-3	

TYPICAL OPERATING PROCEDURES

Polarity ⁽⁵⁾	Current (Amps)	
	3.2 mm (1/8 in)	4.0 mm (5/32 in)
DC+	80-155	130-210
AC	80-160	140-215

⁽¹⁾Typical all weld metal. ⁽²⁾Measured with 0.2% offset. ⁽³⁾See test results disclaimer ⁽⁴⁾In order to meet the alloy requirements of the "G" group, the undiluted weld metal shall have the minimum of at least one of the elements listed. ⁽⁵⁾Preferred polarity is listed first.

PIPELINER® 70S-6

Mild & Low Alloy Steel Pipe · AWS ER70S-6

KEY FEATURES

- An engineered alloy providing superior impact toughness at low temperatures
- Q2 Lot® - Certificates showing actual wire composition and actual mechanical properties available online
- Microguard® Ultra provides superior feeding and arc stability throughout all four quadrants of the pipe
- ProTech® packaging system
- Meets NACE MR0175 for sour gas applications
- Test data available for SSC (NACE TM0177) & HIC (NACE TM0284)

WELDING POSITIONS

All

DIAMETERS / PACKAGING

Diameter mm [in]	10 lb (4.5 kg) Plastic Spool (Vacuum Sealed Foil Bag)	33lb (15kg) Plastic Spool (Vacuum Sealed Foil Bag)
0.9 (0.035)	ED037798	ED037799
1.0 (0.040)	ED036531	ED036532
1.2 (0.047)	ED037505	ED036535

MECHANICAL PROPERTIES⁽¹⁾ – As Required per AWS A5.18

	Yield Strength ⁽²⁾ MPa (ksi)	Tensile Strength MPa (ksi)	Elongation %	Charpy V-Notch J (ft-lbf)	
				@-29°C (-20°F)	@-50°C (-58°F)
Requirements - AWS ER70S-6 As-Welded with 100% CO ₂	400 (58) min	485 (70) min	22 min	27 (20) min	Not Specified
Typical Results⁽³⁾ As-Welded with 100% CO ₂	470 (68)	580 (84)	28	90 (66)	-
Typical Results⁽⁴⁾ As-Welded with 80% Ar/20% CO ₂	641 (93)	710 (103)	22	123 - 144 (91-106)	87 - 110 (64-81)

WIRE COMPOSITION – As Required per AWS A5.18

	%C	%Mn	%Si	%S	%P
Requirements - AWS ER70S-6	0.06-0.15	1.40-1.85	0.8-1.15	0.035 max	0.025 max
Typical Results⁽³⁾	0.10	1.46	0.82	0.009	0.005
	%Cr	%Ni	%Mo	%V	%Cu (Total) ⁽⁵⁾
Requirements - AWS ER70S-6	0.15 max	0.015 max	0.15 max	0.03 max	0.50 max
Typical Results⁽³⁾	0.03	0.01	0	<0.003	0.17

TYPICAL OPERATING PROCEDURES

Diameter, Polarity Shielding Gas	CTWD ⁽⁶⁾ mm [in]	Wire Feed Speed m/min [in/min]	Voltage (volts)	Approx. Current (amps)	Melt-Off Rate kg/hr [lb/hr]
1.0 mm (0.040 in), DC+ 75-95% Ar / Balance CO ₂	12-19 (1/2-3/4)	2.5-14.0 (100-550)	19-31	105-320	1.0-5.2 (2.1-11.5)
1.2 mm (0.047 in), DC+ 75-95% Ar / Balance CO ₂	12-19 (1/2-3/4)	3.2-12.7 (125-500)	19-31	145-360	1.7-6.5 (3.7-14.3)

⁽¹⁾Typical all weld metal. ⁽²⁾Measured with 0.2% offset. ⁽³⁾See test results disclaimer ⁽⁴⁾Results are as-welded in a simulated groove pipe joint in the flat position with X70 base plate, at 18kJ/in heat input.

⁽⁵⁾Copper due to any coating on the electrode plus the copper content of the filler metal itself, shall not exceed the stated 0.50% max.

⁽⁶⁾CTWD (Contact Tip to Work Distance). Subtract 1/4 in. (6.4 mm) to calculate Electrical Stickout.

CONFORMANCES

AWS A5.5:	ER70S-6
ABS:	3YSA
ISO 14341-A	G 42 3 C1 3Si1, G 46 4 M21 3Si1

TYPICAL APPLICATIONS

- Root pass welding
- Hot, fill and cap pass welding of up to X70 grade pipe

SHIELDING GAS

100% CO₂
75-95% Argon / Balance CO₂
Flow Rate: 30 - 50 CFH

PIPELINER® 70S-G

Mild & Low Alloy Steel Pipe · AWS ER70S-G

KEY FEATURES

- Root pass capability up to API Grade X100 and hot, fill and cap pass up to X70 grade pipe
- Good back bead shape on STT® root passes
- Q2 Lot® - Certificates showing actual wire composition and actual mechanical properties available online
- Low silicon level for minimal clean-up
- ProTech® packaging system

WELDING POSITIONS

All

CONFORMANCES

AWS A5:	ER70S-G
ISO:	G 49A Z C1 SZ
ISO 14341-B	G 49 A Z C1 SZ

TYPICAL APPLICATIONS

- Root pass welding of up to X100 grade pipe
- Hot, fill and cap pass welding of up to X70 grade pipe

SHIELDING GAS

100% CO₂
75-95% Argon / Balance CO₂
Flow Rate: 30 - 50 CFH

DIAMETERS / PACKAGING

Diameter mm (in)	10 lb (4.5 kg) Plastic Spool (Vacuum Sealed Foil Bag)	25 lb (11.3 kg) Plastic Spool (Vacuum Sealed Foil Bag)
1.1 (0.045)	ED030904	ED030905

MECHANICAL PROPERTIES⁽¹⁾ – As Required per AWS A5.18

	Yield Strength ⁽²⁾ MPa (ksi)	Tensile Strength MPa (ksi)	Elongation %	Charpy V-Notch J (ft·lbf) @ -29°C (-20°F)
Requirements - AWS ER70S-G As-Welded with 100% CO ₂	400 (58) min	485 (70) min	22 min	Not Specified
Typical Results⁽³⁾ As-Welded with 100% CO ₂	405-425 (59-62)	510-40 (74-78)	24-26	54-81 (40-60)

WIRE COMPOSITION – As Required per AWS A5.18

	%C	%Mn	%Si	%S	%P	%Cu
Requirements - AWS ER70S-G	Not Specified					
Typical Results⁽³⁾	0.05-0.15	0.80-1.40	0.30-0.60	≤0.02	≤0.02	≤0.02

TYPICAL OPERATING PROCEDURES

Diameter, Polarity	CTWD ⁽⁴⁾ mm (in)	Wire Feed Speed m/min (in/min)	Voltage (volts)	Approx. Current (amps)	Melt-Off Rate kg/hr (lb/hr)
1.1 mm (0.045 in), DC+	12-19 (1/2-3/4)	3.2-12.7 (125-500)	19-30	145-340	1.5-6.0 (3.4-13.2)

⁽¹⁾Typical all weld metal. ⁽²⁾Measured with 0.2% offset. ⁽³⁾See test results disclaimer ⁽⁴⁾CTWD (Contact Tip to Work Distance). Subtract 1/4 in. (6.4 mm) to calculate Electrical Stickout.

PIPELINER® 80Ni1

Mild & Low Alloy Steel Pipe · AWS ER80S-G

KEY FEATURES

- Root pass capability up to API Grade X100 and hot, fill and cap pass up to X80 grade pipe
- Q2 Lot® - Certificates showing actual wire composition and actual mechanical properties available online
- ProTech® packaging system
- Meets NACE MR0175 for sour gas applications
- Test data available for SSC (NACE TM0177) & HIC (NACE TM0284)

WELDING POSITIONS

All

SHIELDING GAS

75-95% Argon / Balance CO₂

DIAMETERS / PACKAGING

Diameter mm (in)	10 lb (4.5 kg) Plastic Spool (Vacuum Sealed Foil Bag)	33 lb (15 kg) Plastic Spool (Vacuum Sealed Foil Bag)
1.0 (0.040)	ED033121	ED033119
1.2 (0.047)	ED033122	ED033120

CONFORMANCES

AWS A5:	ER80S-G
ABS:	5YQ500SA H10
CWB/CSA:	ER80S-G
DNV:	V Y50MS H5
Lloyd's Register:	5Y50S H5
ISO 14341-A	G 50 6 M21 3Ni1
ISO 14341-B	G 57A 6 M21 SZ

TYPICAL APPLICATIONS

- Excellent wire placement for narrow groove welding
- Offshore

MECHANICAL PROPERTIES⁽¹⁾ – As Required per AWS A5.28

	Yield Strength ⁽²⁾ MPa (ksi)	Tensile Strength MPa (ksi)	Elongation %	Charpy V-Notch J (ft-lbf)	
				@ -29°C [-20°F]	@ -50°C [-58°F]
Requirements - AWS ER80S-G As-Welded with 100% CO ₂	Not Specified	550 (80) min	Not Specified	Not Specified	Not Specified
Typical Results⁽³⁾ As-Welded 100% CO ₂ As-Welded 80% Ar/20% CO ₂	585-620 (85-90) 620-690 (90-100)	620-690 (90-100) 690-760 (100-110)	28-29 27-28	72-92 (53-68) 99-119 (73-88)	34-61 (25-45) 69-95 (51-70)

WIRE COMPOSITION – As Required per AWS A5.28

	%C	%Mn	%Si	%Ni ⁽⁴⁾	%Ti	%S
Requirements - AWS ER80S-G ⁽⁴⁾ EN ISO 14341-A-G 3Ni1	Not Specified 0.06-0.14	Not Specified 1.00-1.60	Not Specified 0.50-0.90	≥0.50 0.80-1.50	Not Specified ≤0.15	Not Specified ≤0.020
Typical Results⁽³⁾	0.07-0.08	1.50-1.60	0.65-0.75	0.85-0.95	≤0.10	≤0.015
	%P	%Cu	%Cr	%Mo	%V	%Al
Requirements - AWS ER80S-G EN ISO 14341-A-G 3Ni1	Not Specified ≤0.020	Not Specified ≤0.35	Not Specified ≤0.15	Not Specified ≤0.15	Not Specified ≤0.03	Not Specified ≤0.02
Typical Results⁽³⁾	≤0.015	≤0.20	≤0.05	≤0.01	≤0.01	≤0.01

TYPICAL OPERATING PROCEDURES

Diameter, Polarity Shielding Gas	CTWD ⁽⁵⁾ mm (in)	Wire Feed Speed m/min (in/min)	Voltage (volts)	Approx. Current (amps)	Melt-Off Rate kg/hr (lb/hr)
1.0 mm (0.040 in), DC+ 75-95% Ar/Balance CO ₂	12-19 (1/2-3/4)	2.5-14.0 (100-550)	19-31	105-320	1.0-5.2 (2.1-11.5)
1.2 mm (0.047 in), DC+ 75-95% Ar/Balance CO ₂	12-19 (1/2-3/4)	3.2-12.7 (125-500)	19-31	145-360	1.7-6.5 (3.7-14.3)

⁽¹⁾Typical all weld metal. ⁽²⁾Measured with 0.2% offset. ⁽³⁾See test results disclaimer. ⁽⁴⁾To meet the ER80S-G classification, weld deposit must have minimum of 1 or more of the following: 0.50% Ni, 0.30% Cr or 0.20% Mo. ⁽⁵⁾For Electrical Stickout (ESO) subtract 6.4 mm (0.25 in.) from CTWD.

PIPELINER® NR® -207+

Low Alloy, All Position · AWS E71T8-K6

KEY FEATURES

- Vertical down hot, fill and cap pass welding of up to X70 grade pipe
- Capable of producing weld deposits with impact toughness exceeding 27 J (20 ft-lbf) at -29°C (-20°F)
- Q2 Lot® - Certificate showing actual deposit chemistry and mechanical properties available online
- High deposition rates
- ProTech® hermetically sealed packaging

CONFORMANCES

AWS A5: E71T8-K6
ISO 17632-B T49 3 T8-1 NO A-N1 H15

TYPICAL APPLICATIONS

- Hot, fill and cap pass welding of up to X70 grade pipe

WELDING POSITIONS

All, except vertical up

DIAMETERS / PACKAGING

Diameter in (mm)	14 lb (6.4 kg) Coil 56 lb (25.4 kg) Hermetically Sealed Pail
5/64 (2.0)	ED030924

MECHANICAL PROPERTIES⁽¹⁾ – As Required per AWS A5.29

	Yield Strength ⁽²⁾ MPa (ksi)	Tensile Strength MPa (ksi)	Elongation %	Charpy V-Notch J (ft-lbf) @ -29°C (-20°F)
Requirements - AWS E71T8-K6	400 (58) min	485-620 (70-90)	20 min	27 (20) min
Typical Results ⁽³⁾ - As-Welded	425-470 (62-68)	540-565 (78-82)	29-31	119-205 (88-151)

DEPOSIT COMPOSITION⁽¹⁾ - As Required per AWS A5.29

	%C	%Mn	%Si	%P	%S	
Requirements - AWS E71T8-K6	0.15 max	0.50-1.50	0.80 max	0.030 max	0.030 max	
Typical Results ⁽³⁾	0.04-0.06	1.18-1.33	0.24 - 0.28	≤ 0.01	≤ 0.01	
	%Ni	%Cr	%Mo	%V	%Al	%B
Requirements - AWS E71T8-K6	0.40-1.00	0.20 max	0.15 max.	0.05 max	1.8 max	Not Specified
Typical Results ⁽³⁾	0.78-0.93	0.02-0.03	0.01-0.02	< 0.01	0.9-1.2	< 0.001

TYPICAL OPERATING PROCEDURES

Diameter, Polarity	CTWD ⁽⁴⁾ mm (in)	Wire Feed Speed m/min (in/min)	Voltage (volts)	Approx. Current (amps)	Melt-Off Rate kg/hr (lb/hr)
5/64 in (2.0 mm), DC-	19 (3/4)	1.7-3.3 (70 -130)	18-21	210-305	2.0-3.7 (4.3-8.1)

⁽¹⁾Typical all weld metal. ⁽²⁾Measured with 0.2% offset. ⁽³⁾See test results disclaimer ⁽⁴⁾For electrical stickout (ESO) subtract 6.4 mm (1/4 in) from contact tip to work distance (CTWD).
NOTE: This product contains micro-alloying elements. Additional information available upon request.

PIPELINER® NR®-208-P

Low Alloy, All Position · AWS E81T8-G

KEY FEATURES

- Vertical down hot, fill and cap pass welding of up to X70 grade pipe
- Designed to meet 27 J [20 ft-lbf] @ 0°C [32°F] in pipe applications
- Q2 Lot® - Certificate showing actual deposit chemistry and mechanical properties available online
- ProTech® hermetically sealed packaging
- Designed to accommodate applications requiring Nickel content of 1% max
- Excellent operator appeal for pipe applications

CONFORMANCES

AWS A5: E81T8-G-H8

TYPICAL APPLICATIONS

- Hot, fill and cap pass welding of up to X70 grade pipe
- Warm weather cross country pipe applications
- Meets requirements for NACE applications

WELDING POSITIONS

All, except vertical up

DIAMETERS / PACKAGING

Diameter mm (in)	6.4 kg (14 lb) Coil 25.4 kg (56 lb) Hermetically Sealed Pail
2.0 [5/64]	ED032890

MECHANICAL PROPERTIES⁽¹⁾

	Yield Strength ⁽²⁾ MPa (ksi)	Tensile Strength MPa (ksi)	Elongation %	Charpy V-Notch J (ft-lbf) @ -29°C [-20°F]
Requirements - AWS A5.29: E81T8-G	470 (68) min	550-690 (80-100)	19 min	Not Specified
Typical Results⁽³⁾ - As-Welded	480-520 (70-75)	600-630 (87-91)	24-30	50-100 (35-75)

DEPOSIT COMPOSITION⁽¹⁾

	%C	%Mn ⁽⁴⁾	%Si	%P	%S
Requirements - AWS A5.29: E81T8-G	Not Specified	0.50 min	1.00 max	0.030 max	0.030 max
Typical Results⁽³⁾	0.04-0.08	1.74-1.99	0.33-0.38	0.012-0.019	<0.010
	%Ni ⁽⁴⁾	%Cr ⁽⁴⁾	%Mo ⁽⁴⁾	%V ⁽⁴⁾	%Al
Requirements - AWS A5.29: E81T8-G	0.50 min	0.30 min	0.20 min	0.10 min	1.8 max
Typical Results⁽³⁾	0.65-0.95	≤0.05	≤0.03	≤0.03	0.9-1.2

TYPICAL OPERATING PROCEDURES

Diameter, Polarity	CTWD ⁽⁵⁾ mm (in)	Wire Feed Speed m/min (in/min)	Voltage (volts)	Approx. Current (amps)	Melt-Off Rate kg/hr (lb/hr)	Deposition Rate kg/hr (lb/hr)	Efficiency (%)
2.0 mm [5/64 in] DC-	19 [3/4]	1.7-3.3 [70-130]	18-21	210-305	1.8-3.5 [4.0-7.6]	1.5-2.9 [3.3-6.4]	82-83

⁽¹⁾Typical all weld metal. ⁽²⁾Measured with 0.2% offset. ⁽³⁾See test results disclaimer. ⁽⁴⁾In order to meet the alloy requirements of the "G" group, the undiluted weld metal shall have not less than the minimum of at least one of the elements listed. ⁽⁵⁾For electrical stickout (ESO) subtract 6.4 mm (1/4 in) from contact tip to work distance (CTWD).

PIPELINER® NR® -208-XP

Low Alloy, All Position · AWS E81T8-G

KEY FEATURES

- Vertical down hot, fill and cap pass welding of up to X70 grade pipe
- Capable of producing weld deposits with impact toughness exceeding 122 J (90 ft-lbf) @ -40°C (-40°F)
- Q2 Lot® - Certificate showing actual deposit chemistry and mechanical properties available online
- ProTech® hermetically sealed packaging

CONFORMANCES

AWS A5: E81T8-G
ISO 17632-B T 55 4 T8-1 NO A-G H15

TYPICAL APPLICATIONS

- Hot, fill and cap pass welding of up to X70 grade pipe
- Cold temperature cross country pipe applications

WELDING POSITIONS

All, except vertical up

DIAMETERS / PACKAGING

Diameter mm (in)	14 lb (6.4 kg) Coil 56 lb (25.4 kg) Hermetically Sealed Pail
1.7 (0.068)	ED036650
2.0 (5/64)	ED031968

MECHANICAL PROPERTIES⁽¹⁾

	Yield Strength ⁽²⁾ MPa (ksi)	Tensile Strength MPa (ksi)	Elongation %	Charpy V-Notch J (ft-lbf)	
				@ -29°C (-20°F)	@ -40°C (-40°F)
Requirements - AWS A5.29: E81T8-G AWS A5.36: E81T8-A4-K12	470 (68) min	550 - 690 (80 - 100)	19 min	Not Specified	Not Specified 27 (20) min
Typical Results⁽³⁾ - As-Welded	500-550 (73-79)	575-615 (84-89)	21-28	131-200 (97-147)	88-143 (65-105)

DEPOSIT COMPOSITION⁽¹⁾

	%C	%Mn ⁽⁴⁾	%Si	%P	%S
Requirements - AWS A5.29: E81T8-G AWS A5.36: E81T8-A4-K12	Not Specified 0.15 max	0.50 min 1.50 - 2.75	1.00 max 0.80 max	0.030 max	0.030 max
Typical Results⁽³⁾	0.01-0.04	2.21-2.53	0.12-0.14	0.013	0.003
	%Ni ⁽⁴⁾	%Cr ⁽⁴⁾	%Mo ⁽⁴⁾	%V ⁽⁴⁾	%Al ⁽⁴⁾
Requirements - AWS A5.29: E81T8-G AWS A5.36: E81T8-A4-K12	0.50 min 0.75 - 2.00	0.30 min 0.20 max	0.20 min 0.50 max	0.10 min 0.05 max	1.8 max
Typical Results⁽³⁾	1.04-1.26	0.04-0.07	<0.02	<0.006	0.9-1.2

TYPICAL OPERATING PROCEDURES

Diameter, Polarity	CTWD ⁽⁵⁾ mm (in)	Wire Feed Speed m/min (in/min)	Voltage (volts)	Approx. Current (amps)	Melt-Off Rate kg/hr (lb/hr)	Deposition Rate kg/hr (lb/hr)	Efficiency (%)
1.7mm (0.068 in) DC-	19 (3/4)	1.7-3.8 (70-150)	16-22	165-250	1.4-3.1 (3.1-6.8)	1.1-2.5 (2.5-5.5)	78-81
2.0 mm (5/64 in) DC-	19 (3/4)	1.7-3.3 (70-130)	17-20	195-295	1.8-3.5 (4.0-7.6)	1.5-2.9 (3.3-6.4)	82-83

⁽¹⁾Typical all weld metal. ⁽²⁾Measured with 0.2% offset. ⁽³⁾See test results disclaimer. ⁽⁴⁾In order to meet the alloy requirements of the "G" group, the undiluted weld metal shall have not less than the minimum of at least one of the elements listed. ⁽⁵⁾For electrical stickout (ESO) subtract 6.4 mm (1/4 in) from contact tip to work distance (CTWD).

PIPELINER® 81M

Low Alloy, All Position · AWS E81T1-GM

KEY FEATURES

- Designed for optimal performance in automated pipe welding applications where a consistent arc length is critical.
- Flat bead shape, fast freezing slag provides consistent puddle support all the way around the pipe.
- Capable of producing weld deposits with impact toughness exceeding 27 J (20 ft-lbf) at -40°C (-40°F).
- Q2 Lot® - Certificate showing actual deposit chemistry and mechanical properties per lot available online.
- ProTech® foil bag packaging

WELDING POSITIONS

All

DIAMETERS / PACKAGING

Diameter mm [in]	10 lb (4.5 kg) Plastic Spool (Vacuum Sealed Foil Bag)	25 lb (11.3 kg) Plastic Spool (Vacuum Sealed Foil Bag)
1.2 (0.047)	ED033320	ED033321

MECHANICAL PROPERTIES⁽¹⁾ – As Required per AWS A5.29

	Yield Strength ⁽²⁾ MPa (ksi)	Tensile Strength MPa (ksi)	Elongation %	Charpy V-Notch J (ft-lbf)	
				@-29°C (-20°F)	@-40°C (-40°F)
Requirements - AWS E81T1-GM	470 (68) min	550-690 (80-100)	19 min	Not Specified	Not Specified
Typical Results⁽³⁾ As-Welded with 75% Ar/25% CO ₂	510-560 (74-81)	580-620 (84-90)	25-29	83-149 (61-110)	66-131 (49-97)

DEPOSIT COMPOSITION⁽¹⁾ – As Required per AWS A5.29

	%C	%Mn ⁽⁴⁾	%Si ⁽⁴⁾	%P
Requirements - AWS E81T1-GM	Not Specified	0.50	1.00	0.030 max
Typical Results⁽³⁾ As-Welded with 75% Ar/25% CO ₂	0.06-0.07	1.54-1.68	0.34-0.37	0.010-0.015
	%S	%Ni ⁽⁴⁾	%B	Diffusible Hydrogen (mL/100g weld deposit)
Requirements - AWS E81T1-GM	0.030 max	0.50	Not Specified	Not Specified
Typical Results⁽³⁾ As-Welded with 75% Ar/25% CO ₂	0.010-0.020	0.85	0.005-0.006	4-5

TYPICAL OPERATING PROCEDURES

Diameter, Polarity, Shielding Gas	CTWD mm (in)	Wire Feed Speed m/min (in/min)	Voltage (volts)	Approx. Current (amps)	Melt-Off Rate kg/hr (lb/hr)
1.2 mm (0.047 in) , DC+, 75-85% Ar/ balance CO ₂	19 (3/4)	4.4-10.2 (175 - 400)	23-30	130 - 275	1.8-4.1 (3.9-9.0)

⁽¹⁾Typical all weld metal. ⁽²⁾Measured with 0.2% offset. ⁽³⁾See test results disclaimer

⁽⁴⁾In order to meet the requirements of the G group, the undiluted weld metal shall have not less than the minimum specified for one or more of the elements listed.

NOTE: This product contains micro-alloying elements. Additional information available upon request.

PIPELINER® 91M

Low Alloy, All Position ▪ AWS E91T1-GM-H4

KEY FEATURES

- Designed for optimal performance in automated pipe welding applications where a consistent arc length is critical.
- Flat bead shape, fast freezing slag provides consistent puddle support all the way around the pipe.
- Capable of producing weld deposits with impact toughness exceeding 27 J (20 ft•lbf) at -40°C (-40°F).
- Q2 Lot® - Certificate showing actual deposit chemistry and mechanical properties per lot available online.

WELDING POSITIONS

All

DIAMETERS / PACKAGING

Diameter mm (in)	11 lb (5 kg) Plastic Spool 33 lb (15 kg) Master Carton	33 lb (15 kg) Plastic Spool
1.2 (0.047)	ED0379936	ED0379937

MECHANICAL PROPERTIES⁽¹⁾

	Yield Strength ⁽²⁾ MPa (ksi)	Tensile Strength MPa (ksi)	Elongation %	Charpy V- Notch J (ft•lbs) @ -40°C (-40°F)
Requirements AWS E91T1-GM-H4	540 (78) min	620-760 (90-110)	17 min	Not Specified
Typical Results⁽³⁾ As-Welded with 80% Argon / 20% CO ₂	640 (93)	700 (102)	19	60 (44)

DEPOSIT COMPOSITION⁽¹⁾

	%C	%Mn ⁽⁴⁾	%Si	%P	%S
Requirements - AWS A5.29: E91T1-GM H4	Not Specified	0.50	1.00	0.030 max.	0.030 max.
Typical Results⁽³⁾ As-Welded with 80% Argon / 20% CO ₂	0.05	1.40	0.20	0.013	0.010
	%Ni ⁽⁴⁾	%Cr ⁽⁴⁾	%Mo ⁽⁴⁾	%V ⁽⁴⁾	Diffusible Hydrogen (mL/100g weld deposit)
Requirements - AWS A5.29: E91T1-GM H4	0.50	0.30	0.02	0.10	4
Typical Results⁽³⁾ As-Welded with 80% Argon / 20% CO ₂	1.40	0.05	0.42	0.01	3

TYPICAL OPERATING PROCEDURES

Diameter, Polarity Shielding Gas	CTWD ⁽⁶⁾ mm (in)	Wire Feed Speed m/min (in/min)	Voltage (volts)	Approx. Current (amps)	Melt-Off Rate kg/hr (lb/hr)	Deposition Rate kg/hr (lb/hr)	Efficiency (%)
0.047 in (1.2 mm), DC+, 75-85%Argon/Balance CO ₂	20 (3/4)	4.5 (175)	20-22	130	1.9 (4.2)	1.6 (3.5)	83
		7.0 (275)	23-25	180	3.0 (6.6)	2.5 (5.5)	
		9.5 (375)	25-27	220	4.1 (9.0)	3.4 (7.5)	
		12.7 (500)	27-29	265	5.4 (11.9)	4.5 (9.9)	

CONFORMANCES

AWS A5.29M: E91T1-GM-H4
ISO 18276-A: T 55 4 1,5NiMo P M 2 H5

TYPICAL APPLICATIONS

- Hot, fill and cap pass welding on up to X80 grade pipe
- Fully automated pipe welding
- Semi-automatic pipe welding

SHIELDING GAS

75-85% Argon/Balance CO₂
 Flow Rate: 35-55 CFH

⁽¹⁾Typical all weld metal. ⁽²⁾Measured with 0.2% offset. ⁽³⁾See test results disclaimer. ⁽⁴⁾In order to meet all the requirements of the -G group, the undiluted weld metal shall have not less than the minimum specified for one or more of the elements listed.

PIPELINER® 101M

Low Alloy, All Position · AWS E101T1-GM

KEY FEATURES

- Designed for optimal performance in automated pipe welding applications where a consistent arc length is critical
- Fast freezing slag provides consistent puddle support all the way around the pipe
- Capable of producing weld deposits with impact toughness exceeding 27 J (20 ft-lbf) at -40°C (-40°F)
- Q2 Lot® - Certificate showing actual deposit chemistry and mechanical properties per lot available online.
- ProTech® foil bag packaging

WELDING POSITIONS

All

DIAMETERS / PACKAGING

Diameter mm (in)	10 lb (4.5 kg) Plastic Spool (Vacuum Sealed Foil Bag)	25 lb (11.3 kg) Plastic Spool (Vacuum Sealed Foil Bag)
1.2 (0.047)	ED033807	ED033808

CONFORMANCES

AWS A5: E101T1-GM
ISO 18276-B T 62 4 T1-1 M21 A-N2M2-U H5

TYPICAL APPLICATIONS

- Hot, fill and cap pass welding on up to X80 grade pipe
- Fully automated pipe welding
- Semi-automatic pipe welding
- Meets requirements for NACE applications

SHIELDING GAS

75-80% Argon / Balance CO₂
Flow Rate: 40-60 CFH

MECHANICAL PROPERTIES⁽¹⁾ – As Required per AWS A5.29

	Yield Strength ⁽²⁾ MPa (ksi)	Tensile Strength MPa (ksi)	Elongation %	Charpy V-Notch J [ft-lbf] @-40°C [-40°F]
Requirements - AWS E101T1-GM	610 (88) min	690-830 (100-120)	16 min	Not Specified
Typical Results⁽³⁾ As-Welded with 75% Ar/Balance CO ₂	660-670 (95-97)	700-720 (101-104)	23-25	61-91 (45-68)

DEPOSIT COMPOSITION⁽¹⁾ – As Required per AWS A5.29

	%C	%Mn ⁽⁴⁾	%Si	%P	%S
Requirements - AWS E101T1-GM	Not Specified	0.50	1.00 max	0.030 max	0.030 max
Typical Results⁽³⁾ As-Welded with 75% Ar/25% CO ₂	0.06	1.48-1.61	0.29-0.31	0.008	0.007
	%Ni ⁽⁴⁾	%Mo ⁽⁴⁾	%B	Diffusible Hydrogen (mL/100g weld deposit)	
Requirements - AWS E101T1-GM	0.50	0.20	Not Specified	Not Specified	
Typical Results⁽³⁾ As-Welded with 75% Ar/25% CO ₂	0.76-0.84	0.34-0.36	0.004-0.005	4-5	

TYPICAL OPERATING PROCEDURES

Diameter, Polarity, Shielding Gas	CTWD mm (in)	Wire Feed Speed m/min (in/min)	Voltage (volts)	Approx. Current (amps)	Melt-Off Rate kg/hr (lb/hr)
1.2 mm (0.045 in), DC+, 75-80% Ar/ balance CO ₂	19 (3/4)	4.4-10.2 (175-400)	23-30	130-275	1.8-4.1 (3.9-9.0)

⁽¹⁾Typical all weld metal. ⁽²⁾Measured with 0.2% offset. ⁽³⁾See test results disclaimer

⁽⁴⁾In order to meet the requirements of the G group, the undiluted weld metal shall have not less than the minimum specified for one or more of the elements listed.

NOTE: This product contains micro-alloying elements. Additional information available upon request.

PIPELINER® 111M

Low Alloy, All Position · AWS E111T1-GM

KEY FEATURES

- Designed for optimal performance in automated pipe welding applications where a consistent arc length is critical.
- Fast freezing slag provides consistent puddle support all the way around the pipe.
- Capable of producing weld deposits with impact toughness exceeding 27 J (20 ft-lbf) at -40°C (-40°F).
- Q2 Lot® - Certificate showing actual deposit chemistry and mechanical properties per lot available online.
- ProTech® foil bag packaging

WELDING POSITIONS

All

CONFORMANCES

AWS A5: E111T1-GM
ISO 18276-B T76 4 T1-1 M21 A-G H5

TYPICAL APPLICATIONS

- Hot, fill and cap pass welding on X80 to X100 grade pipe
- Fully automated pipe welding
- Semi-automatic pipe welding

SHIELDING GAS

75 - 85% Argon / Balance CO₂
Flow Rate: 40-60 CFH

DIAMETERS / PACKAGING

Diameter mm (in)	10 lb (4.5 kg) Plastic Spool (Vacuum Sealed Foil Bag)	25 lb (11.3 kg) Plastic Spool (Vacuum Sealed Foil Bag)
1.2 (0.047)	ED033745	ED033746

MECHANICAL PROPERTIES⁽¹⁾ – As Required per AWS A5.29

	Yield Strength ⁽²⁾ MPa (ksi)	Tensile Strength MPa (ksi)	Elongation %	Charpy V-Notch J (ft-lbf) @-40°C (-40°F)
Requirements - AWS E111T1-GM	680 (98) min	760-900 (110-130)	15 min	Not Specified
Typical Results⁽³⁾ As-Welded with 75% Ar/25% CO ₂	680-810 (98-118)	760-900 (110-130)	19-23	48-63 (36-47)

DEPOSIT COMPOSITION⁽¹⁾ – As Required per AWS A5.29

	%C	%Mn ⁽⁴⁾	%Si ⁽⁴⁾	%P	%S
Requirements - AWS E111T1-GM	Not Specified	0.50	1.00	0.030 max	0.030 max
Typical Results⁽³⁾ As-Welded with 75% Ar/25% CO ₂	0.06-0.07	1.40-1.80	0.27-0.34	≤0.010	≤0.010
	%Ni ⁽⁴⁾	%Mo ⁽⁴⁾	%B	Diffusible Hydrogen (mL/100g weld deposit)	
Requirements - AWS E111T1-GM	0.50	0.20	Not Specified	Not Specified	
Typical Results⁽³⁾ As-Welded with 75% Ar/25% CO ₂	1.90-2.60	0.65-0.85	0.004-0.005	4-5	

TYPICAL OPERATING PROCEDURES

Diameter, Polarity, Shielding Gas	CTWD mm (in)	Wire Feed Speed m/min (in/min)	Voltage (volts)	Approx. Current (amps)	Melt-Off Rate kg/hr (lb/hr)
1.2 mm (0.047 in), DC+, 75-85% Ar/ balance CO ₂	19 (3/4)	4.4-10.2 (175 - 400)	23-30	130 - 275	1.8-4.1 (3.9-9.0)

⁽¹⁾Typical all weld metal. ⁽²⁾Measured with 0.2% offset. ⁽³⁾See test results disclaimer

⁽⁴⁾In order to meet the requirements of the G group, the undiluted weld metal shall have not less than the minimum specified for one or more of the elements listed.

NOTE: This product contains micro-alloying elements. Additional information available upon request.

PIPELINER® G90M

Low Alloy, All Position · AWS E111T1-K3M-JH8

KEY FEATURES

- Capable of producing weld deposits with impact toughness exceeding 27 J (20 ft-lbf) at -29°C (-20°F)
- Q2 Lot® - Certificate showing actual deposit chemistry available online
- High stacking efficiency
- ProTech® hermetically sealed packaging

WELDING POSITIONS

All, except vertical down

CONFORMANCES

AWS A5: E111T1-K3M-JH8

TYPICAL APPLICATIONS

- For applications requiring high strength weld metal

SHIELDING GAS

75 - 80% Argon / Balance CO₂
Flow Rate: 40 - 50 CFH

DIAMETERS / PACKAGING

Diameter mm (in)	10 lb (4.5 kg) Plastic Spool (Vacuum Sealed Foil Bag)	33 lb (15 kg) Plastic Spool (Vacuum Sealed Foil Bag)
1.2 (0.047)	ED032664	ED031931
1.3 (0.052)		

MECHANICAL PROPERTIES⁽¹⁾ – As Required per AWS A5.29

	Yield Strength ⁽²⁾ MPa (ksi)	Tensile Strength MPa (ksi)	Elongation %	Charpy V-Notch J (ft-lbf) @ -29°C (-20°F)
Requirements - AWS E111T1-K3M-JH8	675 (98) min	760-860 (110-130)	15 min	27 (20) min
Typical Results⁽³⁾ As-Welded with 75% Ar/25% CO ₂	760-825 (110-120)	795-860 (115-125)	19-22	56-85 (41-63)

DEPOSIT COMPOSITION⁽¹⁾ – As Required per AWS A5.29

	%C	%Mn	%Si	%P	%S	%Ni
Requirements - AWS E111T1-K3M-JH8	0.15 max	0.75-2.25	0.80 max	0.030 max	0.030 max	1.25-2.60
Typical Results⁽³⁾ As-Welded with 75% Ar/25% CO ₂	0.05-0.07	1.45-1.70	0.21-0.28	0.01-0.02	0.01-0.02	1.80-2.22
	%Cr	%Mo	%V	%B	Diffusible Hydrogen (mL/100g weld deposit)	
Requirements - AWS E111T1-K3M-JH8	0.15 max	0.25-0.65	0.05 max	Not Specified	8.0 max	
Typical Results⁽³⁾ As-Welded with 75% Ar/25% CO ₂	0.03-0.06	0.50-0.61	0.02	0.005-0.007	2-5	

TYPICAL OPERATING PROCEDURES

Diameter, Polarity, Shielding Gas	CTWD ⁽⁴⁾ mm (in)	Wire Feed Speed m/min (in/min)	Voltage (volts)	Approx. Current (amps)	Melt-Off Rate kg/hr (lb/hr)
1.2 mm (0.045 in), DC+, 75-80% Ar/ balance CO ₂	25 (1)	4.4-10.2 (175-400)	23-30	130-275	1.8-4.1 (3.9-9.0)
1.3 mm (0.052), DC+, 75-80% Ar/ balance CO ₂	25 (1)	4.4-9.5 (175-375)	23-30	130-275	2.5-5.0 (5.5-11.0)

⁽¹⁾Typical all weld metal. ⁽²⁾Measured with 0.2% offset. ⁽³⁾See test results disclaimer. ⁽⁴⁾For electrical stickout (ESO) subtract 6.4 mm (1/4 in) from contact tip to work distance (CTWD).
NOTE: This product contains micro-alloying elements. Additional information available upon request.

PIPE GRADES

PIPE GRADES

Pipe grades are classified in accordance with API 5L specification. The specification established requirements for two product specification levels – PSL 1 and PSL 2. Reference API 5L for full specifications.

PSL 1: Includes requirements for chemistry, ductility, minimum yield strength, and minimum tensile strength.

PSL 2: Adds requirements for maximum yield strength, and maximum tensile strength.

API SPECIFICATION 5L, 44TH EDITION

Requirements for the Results of Tensile Tests for PSL 1 Pipe

Grade	Yield Strength Minimum		Ultimate Tensile Strength Minimum	
	MPa	ksi	MPa	ksi
A25	175	25	310	45
A25P	175	25	310	45
A	210	31	335	49
B	245	36	415	60
X42	290	42	415	60
X46	320	46	435	63
X52	360	52	460	67
X56	390	57	490	71
X60	415	60	520	75
X65	450	65	535	78
X70	485	70	570	83

API SPECIFICATION 5L, 44TH EDITION

Requirements for the Results of Tensile Tests for PSL 2 Pipe

Grade	Yield Strength Minimum		Yield Strength Maximum		Ultimate Tensile Strength Minimum		Ultimate Tensile Strength Maximum	
	MPa	ksi	MPa	ksi	MPa	ksi	MPa	ksi
B	245	36	450	65	415	60	760	110
X42	290	42	495	72	415	60	760	110
X46	320	46	525	76	435	63	760	110
X52	360	52	530	77	460	67	760	110
X56	390	57	545	79	490	71	760	110
X60	415	60	565	82	520	75	760	110
X65	450	65	600	87	535	78	760	110
X70	485	70	635	92	570	83	760	110
X80	555	81	705	102	625	91	825	120
X90	625	91	775	112	695	101	915	133
X100	690	100	840	122	760	110	990	144
X120	830	120	1050	152	915	133	1145	166

COMMON PIPE JOINT DESIGNS

A common weld joint for thinner walled pipe is the “API” fitup with a 60 degree included angle, a 1.6 mm (1/16 in) and 1.6 mm (1/16 in).

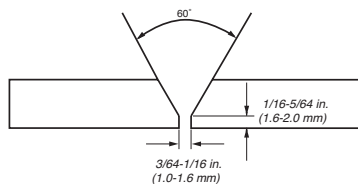

Wall thickness $\leq 3/4\text{ in}$ ($\leq 20\text{ mm}$)

As an alternative, for thicker-walled pipe [>20 mm (>3/4 in)], a compound bevel can be used. The amount of material required to fill a compound bevel joint is less than that for a 60 degree included angle preparation, so productivity may be increased.

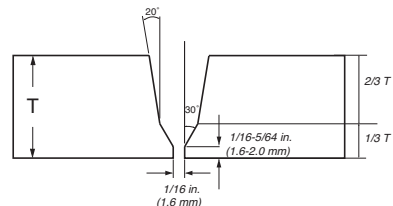

Wall thickness >math>3/4\text{ in}</math> (>math>20\text{ mm}</math>)

ELECTRODE SELECTION GUIDE

ELECTRODE SELECTION GUIDE

Products	AWS Classification	Low Strength				High Strength		
		<X60	X60	X65	X70	X80	X90	X100

MANUAL ELECTRODES

Stick (SMAW) Electrodes - Cellulosic

Pipeliner® 6P+	E6010	R+F	R+F	R	R	R		
Pipeliner® 7P+	E7010-P1		R+F	R+F	R	R		
Pipeliner® 8P+	E8010-P1		R+F	R+F	R+F	R		

Stick (SMAW) Electrodes - Basic, Low Hydrogen, Vertical Up

Pipeliner® 16P	E7016 H4	R	R	R	R	R	R	R
Pipeliner® 18P	E8018-G H4R		F	F	F			
Pipeliner® 19P	E10018-G H4R			F	F	F	F	

Stick (SMAW) Electrodes - Basic, Low Hydrogen, Vertical Down

Pipeliner® LH-D80	E8045-P2 H4R		F	F	F			
Pipeliner® LH-D90	E9045-P2 H4R			F	F	F		
Pipeliner® LH-D100	E10045-P2 H4R				F	F	F	

SEMI-AUTOMATIC / AUTOMATIC

MIG (GMAW) Wires - Solid

Pipeliner® 70S-G	ER70S-G	R+F	R+F	R+F	R+F	R	R	R
Pipeliner® 80S-G	ER80S-G		R+F	R+F	R+F	R+F	R	R
Pipeliner® 80Ni1	ER80S-G		R+F	R+F	R+F	R+F	R	R

Flux-Cored (FCAW-S) Wires - Self-Shielded

Pipeliner® NR®-207+	E71T8-K6	F	F	F				
Pipeliner® NR®-208-P	E81T8-G		F	F	F			
Pipeliner® NR®-208-XP	E81T8-G		F	F	F			

Flux-Cored (FCAW-G) Wires - Gas-Shielded

Pipeliner® 81M	E81T1-GM	F	F	F	F			
Pipeliner® 101M	E101T1-GM		F	F	F	F		
Pipeliner® 111M	E111T1-GM					F	F	F

R = Root Pass Only R+F = Root & Fill Passes F = Fill Pass Only

LH-D80/90/100

Welding Guidelines

PIPELINER® LH-D WELDING - HELPFUL HINTS

Pipeliners® LH-D80, LH-D90 and LH-D100 are low hydrogen, high deposition electrodes specially designed for the vertical down welding of pipe. They are recommended for fill and cap pass welding of up to X70, X80 and X90 pipe, as well as pipe repair and hot tapping applications. For low diffusible hydrogen, high productivity and operator appeal – choose Pipeliners® LH-D electrodes.

Use Recommended Starting and Stopping Techniques

Porosity can be the result of incorrect starting or stopping techniques. Refer to Diagram #2 and #5 below.

Make Sure Operating Procedures are Correct

Pipeliners® LH-D electrodes recommended operating ranges are

TYPICAL OPERATING PROCEDURES

Polarity	Current (Amps)		
	3.2 mm (1/8 in)	4.0 mm (5/32 in)	4.5 mm (11/64 in)
DC+	120 - 170	170 - 250	200 - 300

in the table below.

Do Not Re-Strike Electrode

If arc does not initiate on first try, discard electrode and start with a new one.

Technique Tips for Weld Positions

- 12 o'clock Decreased current and rod angle will reduce spatter.
- 3 o'clock Increased current will help hold weld puddle up.
- 6 o'clock A push angle and weave will help flatten bead.

Use the Recommended Weaving Technique

Weaving too wide can cause undercutting and slag entrapment. Use a maximum weave width of approximately 2 times electrode diameter. Refer to Diagram #3 below for directions.

Welding Guidelines Diagram

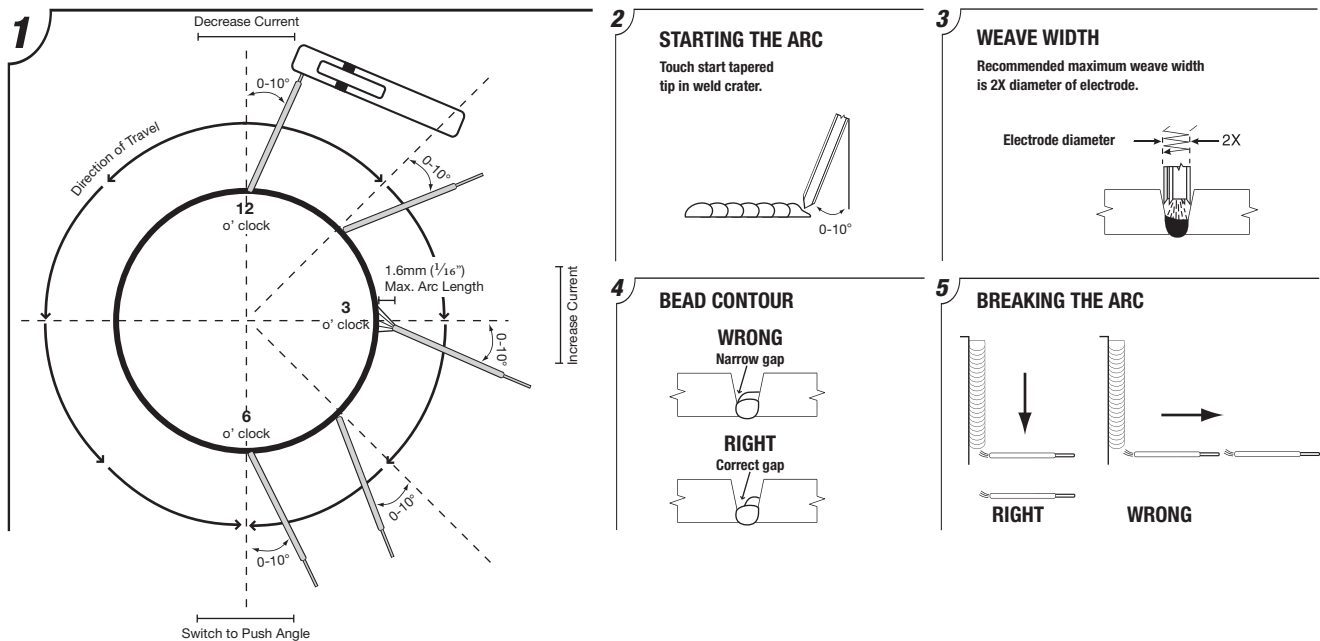

NOTE 1: This table indicates common welding electrodes by API 5L pipe grade. Final product selection should be project specific. The specific electrode recommendation depends on project specifications, including strength overmatch and minimum toughness requirements. For help in selecting the appropriate consumables and other technical questions, please contact our Pipe Welding Application Group at +1.866.635.4709 or email appengr@lincolnelectric.com.

NOTE 2: Please note that the welding consumable recommendations in this table are based on weld metal strength matching the nominal pipe strength based upon API 5L minimum requirements. Recommended consumables in this chart are based upon these standards and not actual strength of pipe.

EN AND ISO CLASSIFICATIONS

ELECTRODE SELECTION GUIDE

Products	EN Classification	ISO Classification
Stick (SMAW) Electrodes - Cellulosic		
Pipeliner® 6P+	EN ISO 2560	ISO 2560
	ISO 2560-A E 42 3 C 2 1	ISO 2560-A E 42 3 C 2 1
Pipeliner® 7P+	EN ISO 2560	ISO 2560
	ISO 2560-A E46 3 1Ni C 2 1	ISO 2560-A E46 3 1Ni C 2 1
Pipeliner® 8P+	EN ISO 2560	ISO 2560
	ISO 2560-A-E 46 4 Z C 2 5 ISO 2560-B-E 55 10-G A U	ISO 2560-A-E 46 4 Z C 2 5 ISO 2560-B-E 55 10-G A U
Stick (SMAW) Electrodes - Basic, Low Hydrogen, Vertical Up		
Pipeliner® 16P	EN ISO 2560	ISO 2560
	ISO 2560-A-E 42 4 B 1 2 H5 ISO 2560-B-E 49 16 A U H5	ISO 2560-A-E 42 4 B 1 2 H5 ISO 2560-B-E 49 16 A U H5
Pipeliner® 18P	EN ISO 2560	ISO 2560
	ISO 2560-A-E 50 6 Mn1Ni B 3 2 H5 ISO 2560-B-E 57 18-G A H5	ISO 2560-A-E 50 6 Mn1Ni B 3 2 H5 ISO 2560-B-E 57 18-G A H5
Pipeliner® 19P	EN 757	ISO 18275
	EN 757 - E 69 5 Mn2NiMo B 3 2 H5	ISO 18275-A-E 69 5 Mn2NiMo B 3 2 H5 ISO 18275-A-E 83 18-G A H5
Stick (SMAW) Electrodes - Basic, Low Hydrogen, Vertical Down		
Pipeliner® LH-D80	EN ISO 2560	ISO 2560
	ISO 2560-A-E 46 4 B 4 5 H5 ISO 2560-B-E 55 15 G A H5	ISO 2560-A-E 46 4 B 4 5 H5 ISO 2560-B-E 55 15 G A H5
Pipeliner® LH-D90	EN 757	ISO 18275
	EN 757 - E 55 4 Z B 4 5 H5	ISO 18275-A-E 55 4 Z B 4 5 H5 ISO 18275-B-E 62 15 G A H5
Pipeliner® LH-D100	EN 757	ISO 18275
	EN 757 - E 62 4 Mn1NiMo B 4 5 H5	ISO 18275-A-E 62 4 Mn1NiMo B 4 5 H5 ISO 18275-B-E 69 15 G A H5

NOTE: The presented EN and ISO classifications are only the approximate classifications based on available test results. Specific EN and ISO classification tests were not performed in most cases.

EN AND ISO CLASSIFICATIONS

ELECTRODE SELECTION GUIDE

Products	EN Classification	ISO Classification
MIG (GMAW) Wires - Solid		
Pipeliner® 70S-G	EN ISO 14341	ISO 14341
	ISO 14341-A-G 38A 3 M G2Si ISO 14341-B-G 49A 3U M G6	ISO 14341-A-G 38A 3 M G2Si ISO 14341-B-G 49A 3U M G6
Pipeliner® 80S-G	EN ISO 14341	ISO 14341
	ISO 14341-A-G 50A 3 M G4Mo ISO 14341-B-G 57A 3U M G4M31	ISO 14341-A-G 50A 3 M G4Mo ISO 14341-B-G 57A 3U M G4M31
Pipeliner® 80Ni1	EN ISO 14341	ISO 14341
	ISO 14341-A-G 3Ni1	ISO 14341-A-G 3Ni1
Flux-Cored (FCAW-S) Wires - Self-Shielded		
Pipeliner® NR®-207+	EN ISO 17632	ISO 17632
	ISO 17632-A-42 3 1Ni Y N 5 H15 ISO 17632-B-49 3 Ni1 T8 N 1 U H15	ISO 17632-A-42 3 1Ni Y N 5 H15 ISO 17632-B-49 3 Ni1 T8 N 1 U H15
Pipeliner® NR®-208-XP	EN ISO 17632	ISO 17632
	ISO 17632-A-46 3 Z Y N 5 H15 ISO 17632-B-55 3 G T8 N1 U H15	ISO 17632-A-46 3 Z Y N 5 H15 ISO 17632-B-55 3 G T8 N1 U H15
Flux-Cored (FCAW-G) Wires - Gas-Shielded		
Pipeliner® 81M	EN ISO 17632	ISO 17632
	ISO 17632-A-T46 4 Mn1Ni PM 1 H5 ISO 17632-B-T554T1-1MA-N1-UH5	ISO 17632-A-T46 4 Mn1Ni PM 1 H5 ISO 17632-B-T554T1-1MA-N1-UH5
Pipeliner® 101M	EN ISO 18276	ISO 18276
	ISO 18276-A-T 62 4ZPM 1 ISO 18276-B-T694T1-1MA-N2M2-UH5	ISO 18276-A-T 62 4ZPM 1 ISO 18276-B-T694T1-1MA-N2M2-UH5
Pipeliner® 111M	EN ISO 18276	ISO 18276
	ISO 18276-A-T 69 4Z PM1- H5 ISO 18276-B-T764T1-1MA-G-H5	ISO 18276-A-T 69 4Z PM1- H5 ISO 18276-B-T764T1-1MA-G-H5

NOTE: The presented EN and ISO classifications are only the approximate classifications based on available test results. Specific EN and ISO classification tests were not performed in most cases.

AGENCY APPROVALS

NOTE: Approvals are updated periodically.

Consult your Lincoln Electric representative for the latest Approval/Grade revisions.

PRODUCT	AWS Code	AWS/ASME CLASS	ABS Grade	Lloyd's Register Grade	DNV Grade	CWB/CSA	CWB/CSA
Stick Electrode							
Pipeliner® 6P+	A5.1	E6010	E6010	-	3	E4310	E4310
Pipeliner® 16P	A5.1	E7016 H4	-	-	-	E4916-H4	-
Pipeliner® 7P+	A5.5	E7010-P1	E7016-H4, E7016-1 H4	-	-	-	-
Pipeliner® 8P+	A5.5	E8010 -P1, E8010-G	E8010 -P1	-	-	E5510-P1	E5510-P1
Pipeliner® Arc 80	A5.5	E8010 P1, E8010 G	-	-	-	E5510-P1, E5510-G	E5510-P1, E5510-G
Pipeliner® 18P	A5.5	E8018-G, E8018-G H4	E8018-G	-	-	-	-
Pipeliner® LH-D80	A5.5	E8045-P2 H4R	E8045-P2 H4R	-	-	E8045-P2, H4R	E8045-P2 H4R
Pipeliner® LH-D90	A5.5	E9045-P2 H4R	E9045-P2 H4R	-	-	E9045-P2, H4R	E9045-P2 H4R
Pipeliner® 19P	A5.5	E10018-G H4R	-	-	-	-	-
Pipeliner® LH-D100	A5.5	E10045-P2 H4R	E10045-P2 H4R	-	-	E10045-P2, H4R	E10045-P2 H4R
MIG & TIG							
Pipeliner® 70S-G	A5.18	ER70S-G	-	-	-	-	
Pipeliner® 80S-G	A5.28	ER80S-G	-	-	-	-	
Pipeliner® 80Ni1	A5.28	ER80S-G	5YQ500 H5	V Y50MS H5	5Y50S H5	-	
MIG & TIG							
Pipeliner® NR®-207+	A5.29	E71T8-K6	-	-	-	-	
Pipeliner® NR®-208-XP	A5.29	E81T8-G	-	-	-	-	
Pipeliner® 81M	A5.29	E81T1-GM	-	-	-	-	
Pipeliner® 101M	A5.29	E101T1-GM	-	-	-	-	
Pipeliner® 111M	A5.29	E111T1-GM	-	-	-	-	

CONSUMABLES

POWER GENERATION & NUCLEAR



Lincoln Electric gives customers the ability to view Lot numbers of a specific product online by going to the Certificate Center under the Support tab and entering the product number.

ACCOUNT CENTER

INVENTORY STATUS

10/12/2012 9:29:21 AM US Eastern Time Zone

Partner Number(SoldTo):	
Sales Organization(SoldTo):	Lincoln Electric Cleveland - US10
Distribution Channel(SoldTo):	Domestic - 10

	Product Number	Description	Kit Product	Requested Quantity	Available Quantity	Ship From	Notes
<input checked="" type="checkbox"/>	ED033842	.035 SUPERARC L-56 N 33# SP (Q2)		33 LB	5,676.00 LB	2012 - CLEVELAND OH US LOT NO 1068D	

SELECT ALL **CLEAR ALL**

Quantities displayed represent existing inventory at time of page view. These quantities are subject to change (as additional products are manufactured and new orders are processed). Inventory for International orders may require transit time.

CHECK PRICE

Customers can then view Q2 Lot Certs by Lot number prior to placing an order.

CERTIFICATE CENTER

CERTIFICATE CENTER

- Global Agency Certifications
- FEMA Certificates
- AWS D1.8 Certificates
- AWS D1.1 Certificates

Q2 Certified and Tested Lot Controlled Materials

Search by Lot Number

Lot Number	Product Size	Product Name
1068D	.035 in.	SUPERARC L-56 N

To place and order please contact your Lincoln Electric representative to order a specific Lot of product.

THE LINCOLN ELECTRIC COMPANY
22801 St. Clair Avenue
Cleveland, Ohio 44117-1199

STATEMENT OF TEST

Q2 Lot# 1068D of .035 SuperArc® L-56 N was manufactured under Lot Control per ASME Section II: SFA 5.01 / AWS A5.01 Class S3 and ASME Section III NB-2400. The following tests were performed on this Lot in accordance with ASME Section III NB-2400 and ASME Section II: SFA 5.01 / AWS A5.01 Schedule K to the requirements of ASME Section II: SFA 5.18 / AWS A5.18 classification E7705-6. This test report is in accordance with EN10204 type 3.1 and ISO 10474 3.1.B. The product stated herein was manufactured and supplied in accordance with the Quality System Program of The Lincoln Electric Company, Cleveland, Ohio, U.S.A. as outlined in the Quality System Manual. The Quality System Program of the Lincoln Electric Company is certified to ISO 9001, is approved by VATTUV, and is accredited by ASME as evidenced by QSC-489, QSC-489-1 and QSC-489-2.

Prior to using this material for ASME Boiler and Pressure Vessel Code Section III applications please contact the Lincoln Electric Special Order Department to receive a CMTR meeting all requirements of NCA-3830.

Test Conditions

Electrode Size	.035
Electrode Polarity	DC+
Current (amps)	230
Ac Voltage (volts)	28
Preheat / Interpass Temp (°F)	28/163 (78/205)
Shielding Gas	75% Ar / 25% CO ₂
Heat #	CB4707

Mechanical Properties

Yield Strength, 2% offset method MPa (ksi)	490 (71)	AWS A5.18-2005
Tensile Strength MPa (ksi)	600 (87)	400 MPa (58 ksi) min.
Elongation %	29	480 MPa (70 ksi) min.

Impacts Properties

Average	153 (113)	27 Joules (208.-lbs.) min.
Joules @ -29°C (ft.-lbs. ave @ -20°F)	146, 157, 155 (108, 116, 114)	
Average	99 (73)	Report Only
Joules @ -40°C (ft.-lbs. ave @ -40°F)	91, 89, 118 (67, 66, 87)	

Wire Chemistry

% Carbon	0.10	0.05-0.15
% Manganese	1.44	1.40-1.55
% Silicon	0.85	0.80-1.15
% Phosphorus	0.008	0.025 max.
% Sulfur	0.005	0.035 max.
% Nickel	0.01	0.15 max.
% Chromium	0.03	0.15 max.
% Molybdenum	<0.01	0.15 max.
% Vanadium	<0.01	0.03 max.
% Copper (Total)	0.19	0.50 max.

Diffusible Hydrogen

Per AWS A4.3 (ml/100g weld metal)	1.3, 1.2, 1.7, 1.5 = 1.4 Average	REPORT ONLY
-----------------------------------	----------------------------------	-------------

This is to certify that the contents of this report are correct and accurate as contained in the records of The Lincoln Electric Company.

Radiographic Test: Met Requirements
 Test assembly constructed of ASTM A38

Ed Lipski Quality Assurance Mgr. 16 Aug 2012
 Date

Tim Peck Special Products Mgr. 11 Aug 2012
 Date

NUCLEAR PRODUCT PORTFOLIO

Nuclear Products are designated with an "N" suffix in the product name. These products have modified chemical composition and/or mechanical properties in the as welded or stress relieve condition to meet (but not limited to) specific requirements for the nuclear industry.

"N" Designators:

- **Excalibur® 7018 MR® N** - Design modified to meet properties after 48 hours stress relief.
- **SuperArc® L-52 N and SuperArc® L-56® N** - Design modified to meet properties after stress relief.
- **Stainless Products with N Suffix** - Cobalt restriction of 0.05% max.

WHAT IS BATCH MANAGEMENT?

Batch Management is lot controlled and tested products with full traceability throughout the manufacturing process. All batch managed products have actual certified material test reports [CMTR] for each Q2 Lot® number. Q2 Lot® certificates can be downloaded from the certificate center on the Lincoln Electric website. Order a specific lot of material, as well as order a single lot or multiple lots of material that best meet your application requirements.

Lincoln Electric's Batch Managed Inventory Program includes a complete portfolio of Q2 Lot® products: SMAW, GMAW, GTAW, Orbital TIG, and FCAW-G wires.

- EXCALIBUR®
- LINCOLN®
- SUPERARC®
- ULTRACORE®
- BLUE MAX®

Batch Managed products are represented with the words "batch" in the top left corner of the product page.

BATCH
|
STICK (SMAW) ELECTRODE

EXCALIBUR® 7018 MR® N

Mild Steel ■ AWS E7018

KEY FEATURES

- Q2 Lot® - Certificate showing actual deposit composition and actual mechanical properties available online
- Available as Batch Managed Inventory
- "N" Designator - design modified to meet properties after

CONFORMANCES

AWS A5.1/A5.1M: 2004:

ASME SFA-A5.1:

EXCALIBUR® 7018 MR® N

Mild Steel · AWS E7018

KEY FEATURES

- Q2 Lot® - Certificate showing actual deposit composition and actual mechanical properties available online
- Available as Batch Managed Inventory
- "N" Designator - design modified to meet properties after 48 hours stress relief
- Premium arc performance
- Square coating burn-off
- Easy strike and re-strike
- Effortless slag removal
- Minimal spatter for enhanced operability and clean weld surface
- Impact toughness tested to -46°C (-50°F)
- Capable of exceeding AWS minimum requirement of 480 MPa (70 ksi) tensile and 400 MPa (58 ksi) yield strength after 48 hours of stress relieving at 590-620°C (1100-1150°F)
- Capable of meeting drop weight testing requirements as commonly required for nuclear applications
- Prior to using this material for ASME Boiler and Pressure Vessel Code Section III applications, please contact the Lincoln Electric Specials Department to receive a Certified Material Test Report (CMTR) which meets all requirements of NCA-3860.
- Each rod is marked with AWS classification and LOT number

CONFORMANCES

AWS A5: E7018 H4R, E7018-1 H4R
CWB/CSA: E4918-H4R

TYPICAL APPLICATIONS

- Nuclear power plant construction and maintenance
- Power generation
- Petrochemical
- Pressure vessels
- Pressure piping
- Fill and cap pass welding of up to X65 grade pipe

ASME IX QUALIFICATION

ASME IX Qualification: QW432 F-No 4,
 QW442 A-No 1

WELDING POSITIONS

All, Except Vertical Down

DIAMETERS / PACKAGING

Diameter in (mm)	Length in (mm)	8 lb (3.6 kg) Easy Open Can 24 lb (10.9 kg) Master Carton	10 lb (4.5 kg) Easy Open Can 30 lb (13.6 kg) Master Carton
3/32 (2.4)	12 (300)	ED033940	
1/8 (3.2)	14 (350)		ED033838
5/32 (4.0)	14 (350)		ED033839

MECHANICAL PROPERTIES⁽¹⁾ – As Required per AWS A5.1

	Yield Strength ⁽²⁾ MPa (ksi)	Tensile Strength MPa (ksi)	Elongation %	Charpy V-Notch J (ft-lbf)		
				@ -29°C (-20°F)	@ -46°C (-50°F)	@ -50°C (-60°F)
Requirements AWS E7018-1 H4R	400 (58) min	490 (70) min	22 min	27 (20) min	27 (20) min	Not Specified
Typical Results⁽³⁾ As-Welded	440-530 (64-77)	540-630 (79-91)	27-29	90-135 (67-233)	28-177 (21-131)	32-210 (24-155)
Stress Relieved 48 hrs @ 620°C (1150°F)	410-470 (59-68)	500-560 (72-81)	29-31	172-352 (127-260)	–	23-284 (17-210)

DEPOSIT COMPOSITION⁽¹⁾ – As Required per AWS A5.1

	%C	%Mn	%Si	%P	%S
Requirements AWS E7018-1 H4R	0.15 max	1.60 max	0.75 max	0.035 max	0.35 max
Typical Results⁽³⁾	0.06 - 0.08	0.78 - 1.16	0.16 - 0.38	≤0.01	≤0.01
	%Ni	%Cr	%Mo	Diffusible Hydrogen (mL/100g weld deposit)	
Requirements AWS E7018-1 H4R	0.30 max	0.20 max	0.30 max	4.0 max	
Typical Results⁽³⁾	≤0.02	≤0.03	0.20 - 0.25	1 - 3	

TYPICAL OPERATING PROCEDURES

Polarity ⁽⁴⁾	Current (Amps)		
	3/32 in (2.4 mm)	1/8 in (3.2 mm)	5/32 in (4.0 mm)
DC+	70-110	90-160	130-210
AC	80-120	100-160	140-210

⁽¹⁾Typical all weld metal. ⁽²⁾Measured with 0.2% offset. ⁽³⁾See test results disclaimer ⁽⁴⁾Preferred polarity is listed first.

EXCALIBUR® 8018-B2 MR®

Low Alloy Steel · AWS E8018-B2 H4R

KEY FEATURES

- Designed for welding 1.25% chromium, 0.50% molybdenum steel
- Premium arc performance
- Square coating burn-off
- Easy strike, re-strike and slag removal
- Capable of exceeding AWS minimum requirement of 550 MPa (80 ksi) tensile strength after 8 hours of stress-relieving at 690°C (1275°F)
- Meets AWS minimum requirement of 550 MPa (80 ksi) tensile and 470 MPa (68 Ksi) yield strength after 48 hours of stress-relieving at 590-620°C (1100-1150°F) as typical in nuclear applications
- Each rod is marked with AWS classification and LOT number.

WELDING POSITIONS

All, Except Vertical Down

CONFORMANCES

AWS A5: E8018-B2, E8018-B2 H4R

CWB/CSA: E5518-B2

TYPICAL APPLICATIONS

- Power generation
- Petrochemical
- Pressure vessels
- Process piping
- Nuclear steam generators and other components

ASME IX QUALIFICATION

ASME IX Qualification: QW432 F-No 4,
QW442 A-No 3

DIAMETERS / PACKAGING

Diameter in (mm)	Length in (mm)	8 lb (3.6 kg) Easy Open Can	10 lb (4.5 kg) Easy Open Can	25 lb (11.3 kg) Easy Open Can	50 lb (22.7 kg) Easy Open Can
		24 lb (10.9 kg) Master Carton	30 lb (13.6 kg) Master Carton		
3/32 (2.4)	12 (300)	ED032878	ED032879	ED032881	ED032882 ED032883
1/8 (3.2)	14 (350)				
5/32 (4.0)	14 (350)				

MECHANICAL PROPERTIES⁽¹⁾ – As Required per AWS A5.5

	Yield Strength ⁽²⁾ MPa (ksi)	Tensile Strength MPa (ksi)	Elongation %	Charpy V-Notch J (ft-lbf) @ -29°C (-20°F)
Requirements AWS E8018-B2 H4R	460 (67) min	550 (80) min	19 min	Not Specified
Typical Results⁽³⁾ - As-Welded				
Stress-Relieved 1 hr @ 690°C (1275°F)	540-585 (78-85)	640-685 (93-99)	24-26	71-127 (52-94)
Stress-Relieved 8 hrs @ 690°C (1275°F) ⁽⁴⁾	495-540 (72-78)	605-640 (88-93)	25-28	64-127 (47-83)
Stress-Relieved 48 hrs @ 621°C (1150°F) ⁽⁴⁾	560-580 (81-84)	660-680 (96-99)	24-25	28-197 (21-145)

DEPOSIT COMPOSITION⁽¹⁾ – As Required per AWS A5.5

	%C	%Mn	%Si	%P
Requirements AWS E8018-B2 H4R	0.05-0.12	0.90 max	0.80 max	0.03 max
Typical Results⁽³⁾	0.08-0.11	0.65-0.80	0.35-0.55	≤ 0.02
	%S	%Cr	%Mo	Diffusible Hydrogen (mL/100g weld metal)
Requirements AWS E8018-B2 H4R	0.03 max	1.00-1.50	0.40-0.65	4.0 max
Typical Results⁽³⁾	≤ 0.01	1.05-1.30	0.40-0.60	2-4

TYPICAL OPERATING PROCEDURES

Polarity ⁽⁵⁾	Current (Amps)		
	3/32 in (2.4 mm)	1/8 in (3.2 mm)	5/32 in (4.0 mm)
DC+	60-110	85-160	110-210
AC	65-120	90-170	115-220

⁽¹⁾Typical all weld metal. ⁽²⁾Measured with 0.2% offset. ⁽³⁾See test results disclaimer ⁽⁴⁾Industry Specific Data (Not AWS Requirement). ⁽⁵⁾Preferred polarity is listed first.

EXCALIBUR® 9018-G MR N

Low Alloy Steel · AWS E9018-G H4R

KEY FEATURES

- Q2 Lot® - Certificate showing actual deposit composition and actual mechanical properties available online
- "N" Designator - design modified to meet properties after 48 hours stress relief
- Premium arc performance
- Square coating burn-off
- Easy strike and re-strike
- Effortless slag removal
- Capable of exceeding AWS minimum requirement of 620 MPa (90 ksi) tensile and 540 MPa (68 ksi) yield strength after 48 hours of stress relieving at 590-620°C (1100-1150°F)
- Capable of meeting drop weight testing requirements as commonly required for nuclear applications
- Prior to using this material for ASME Boiler and Pressure Vessel Code Section III applications, please contact the Lincoln Electric Specials Department to receive a Certified Material Test Report (CMTR) which meets all requirements of NCA-3860
- Each rod is marked with AWS classification and LOT number

CONFORMANCES

AWS A5: E9018-G H4R

TYPICAL APPLICATIONS

- Nuclear power plant components
- High strength steel, such as HY-80, HY-90 and ASTM A514, A508, A533
- DC welding
- Pressure Vessels

ASME IX QUALIFICATION

ASME IX Qualification: QW432 F-No 4,
QW442 A-No 10

WELDING POSITIONS

All, Except Vertical Down

DIAMETERS / PACKAGING

Diameter in (mm)	Length in (mm)	8 lb (3.6 kg) Easy Open Can 24 lb (10.9 kg) Master Carton	10 lb (4.5 kg) Easy Open Can 30 lb (13.6 kg) Master Carton
3/32 (2.4)	12 (300)	ED033897	ED033898 ED033865
1/8 (3.2)	14 (350)		
5/32 (4.0)	14 (350)		

MECHANICAL PROPERTIES⁽¹⁾ – As Required per AWS A5.1

	Yield Strength ⁽²⁾ MPa (ksi)	Tensile Strength MPa (ksi)	Elongation %	Charpy V-Notch J (ft-lbf)	
				@ -40°C [-40°F]	@ -50°C [-60°F]
Requirements AWS E9018-G H4R	620 (90) min	530 (77) min	17 min	Not Required	Not Required
Typical Results⁽³⁾ As-Welded	590-680 (85-98)	680-770 (99-112)	21-26	74-130 (55-96)	51-111 (38-82)
Stress Relieved 48 hrs @ 620°C (1150°F) on HY-80	540-590 (78-85)	630-670 (91-97)	25-28	33-123 (25-91)	27-98 (20-73)

DEPOSIT COMPOSITION⁽¹⁾ – As Required per AWS A5.5

	%C	%Mn	%Si	%P	%S	%Ni ⁽⁴⁾
Requirements AWS E9018-G H4R	Not Required	1.00 min	0.80 min	0.03 max	0.03 max	0.50 min
Typical Results⁽³⁾	0.09 - 0.12	0.79 - 1.22	0.22 - 0.43	≤0.01	≤0.01	1.54 - 1.79
	%Cr ⁽⁴⁾	%Mo ⁽⁴⁾	%V ⁽⁴⁾	%Cu ⁽⁴⁾	Diffusible Hydrogen (mL/100g weld deposit)	
Requirements AWS E9018-G H4R	0.30 min	0.20 min	0.10 min	0.20 min	4.0 max	
Typical Results⁽³⁾	≤0.03	0.29 - 0.31	≤0.02	≤0.02	1 - 3	

TYPICAL OPERATING PROCEDURES

Polarity ⁽⁵⁾	Current (Amps)		
	3/32 in (2.4 mm)	1/8 in (3.2 mm)	5/32 in (4.0 mm)
DC+	70-110	90-160	130-210
AC	80-120	100-160	140-210

⁽¹⁾Typical all weld metal. ⁽²⁾Measured with 0.2% offset. ⁽³⁾See test results disclaimer⁽⁴⁾In order to meet the alloy requirements of the "G" designation, the undiluted weld metal shall have the minimum of at least one of the elements listed. ⁽⁵⁾Preferred polarity is listed first.

SUPERARC® L-56® N

Mild Steel · AWS ER70S-6

KEY FEATURES

- Q2 Lot® - Certificates showing actual wire composition and mechanical properties available online
- Available as Batch Managed Inventory
- "N" Designator - design modified to meet properties after stress relief
- Uniquely alloyed product to obtain higher strength levels
- High levels of manganese and silicon deoxidizers tolerate medium to heavy mill scale surfaces
- Excellent toe-wetting provides optimal bead appearance
- Copper coated for long contact tip life
- Supports short-circuiting, globular, axial spray and pulsed spray transfer
- MicroGuard® Ultra provides superior feeding and arc stability
- Each spool is identified with AWS classification and LOT number

WELDING POSITIONS

All

CONFORMANCES

AWS A5.18: ER70S-6

ASME SFA-A5.18: ER70S-6

TYPICAL APPLICATIONS

- Nuclear power plant construction and maintenance
- Medium to heavy mill scale base material
- Robotic or hard automation
- Structural steel

ASME IX QUALIFICATION

ASME IX Qualification: QW432 F-No 6

DIAMETERS / PACKAGING

Diameter in (mm)	33 lb (15 kg) Plastic Spool
0.035 (0.9)	ED033842
0.045 (1.1)	ED033843

MECHANICAL PROPERTIES⁽¹⁾ – As Required per AWS A5.18

	Yield Strength ⁽²⁾ MPa (ksi)	Tensile Strength MPa (ksi)	Elongation %	Charpy V-Notch J (ft-lbf)	
				@ -29°C [-20°F]	@ -40°C [-40°F]
Requirements - AWS ER70S-6 As-Welded with 100% CO ₂	400 [58] min	485 [70] min	22 min	27 [20] min	Not Specified
Typical Results⁽³⁾ As-Welded with 100% CO ₂	440 [64]	560 [81]	29	71 [52]	61 [45]
Stress Relieved 1 hr. @ 621°C [1150°F] ⁽⁴⁾	395 [57]	510 [74]	29	95 [70]	68 [50]
As-Welded with 75% Ar/25% CO ₂	460 [67]	565 [82]	27	82 [60]	72 [53]
Stress Relieved 1 hr. @ 621°C [1150°F] ⁽⁴⁾	415 [60]	540 [78]	31	140 [103]	122 [90]
As-Welded with 90% Ar/10% CO ₂	470 [68]	580 [84]	28	119 [88]	78 [57]
Stress Relieved 1 hr. @ 621°C [1150°F] ⁽⁴⁾	440 [64]	550 [80]	32	183 [135]	156 [115]
As-Welded with 98% Ar/2% O ₂	455 [66]	565 [82]	27	122 [90]	108 [80]
Stress Relieved 1 hr. @ 621°C [1150°F] ⁽⁴⁾	415 [60]	545 [79]	34	190 [140]	176 [130]

WIRE COMPOSITION – As Required per AWS A5.18

	%C	%Mn	%Si	%S	%P
Requirements - AWS ER70S-6	0.06-0.15	1.40-1.85	0.80-1.15	0.035 max	0.025 max
Typical Results⁽³⁾	0.08-0.10	1.42-1.60	0.81-0.87	0.006-0.010	0.004-0.010
	%Cr	%Ni	%Mo	%V	%Cu [Total] ⁽⁴⁾
Requirements - AWS ER70S-6	0.15 max	0.15 max	0.15 max	0.03 max.	0.50 max
Typical Results⁽³⁾	0.01-0.05	≤ 0.04	≤ 0.01	< 0.01	0.17-0.22

TYPICAL OPERATING PROCEDURES

Diameter, Polarity Shielding Gas	CTWD mm (in)	Wire Feed Speed m/min (in/min)	Voltage (volts)	Approx. Current (amps)	Melt-Off Rate kg/hr (lb/hr)
0.035 in (0.9 mm), DC+					
Short Circuit Transfer 100% CO ₂	9-12 (3/8-1/2)	2.5 [100]	18	80	0.7 [1.6]
		3.8 [150]	19	120	1.1 [2.4]
		6.4 [250]	22	175	1.8 [4.0]
Spray Transfer 90% Ar/10% CO ₂	12-19 (1/2-3/4)	9.5 [375]	23	195	2.7 [6.0]
		12.7 [500]	29	230	3.6 [8.0]
		15.2 [600]	30	275	4.4 [9.6]
0.045 in (1.1 mm), DC+					
Short Circuit Transfer 100% CO ₂	12-19 (1/2-3/4)	3.2 [125]	19	145	1.5 [3.4]
		3.8 [150]	20	165	1.8 [4.0]
		5.1 [200]	21	200	2.5 [5.4]
Spray Transfer 90% Ar/10% CO ₂	12-19 (1/2-3/4)	8.9 [350]	27	285	4.2 [9.2]
		12.1 [475]	30	335	5.7 [12.5]
		12.7 [500]	30	340	6.0 [13.2]

⁽¹⁾Typical all weld metal. ⁽²⁾Measured with 0.2% offset. ⁽³⁾See test results disclaimer ⁽⁴⁾Industry specific data, not required by AWS.
NOTE: Additional test data available upon request.

SUPERARC® AK-10™

Low Alloy, Copper Coated · AWS ER100S-G

KEY FEATURES

- Capable of producing welds with 690 MPa (100 ksi) tensile strength
- Suitable for use where consumables with less than 1% Ni are required
- Batch Managed Inventory
- Superior feeding and arc stability

WELDING POSITIONS

All

SHIELDING GAS

- 100% CO₂
- 75-95% Argon / Balance CO₂
- 95-98% Argon / Balance O₂
- Flow rate: 30-50CFH

CONFORMANCES

AWS A5.28: ER100S-G

ASME SFA-5.28: ER100S-G

TYPICAL APPLICATIONS

- NACE applications
- Oil tools
- Riser systems
- High-strength pipe

TYPICAL BASE METALS

HY-80 or HY-100 per MIL-S-16216, A514 Grade B or P, AISI 4130 or 8620, API X-70 or X-80

ASME IX Qualification QW442 A-No 1

DIAMETERS / PACKAGING

Diameters in (mm)	33 lb. (15kg) Steel Spool	500 lb. (227kg) Accu-Trak® Drum
0.035 (0.9)	ED034894	ED034896
0.045 (1.1)	ED034895	ED034897

MECHANICAL PROPERTIES – As Required per AWS A5.28

	Yield Strength ⁽¹⁾ MPa [ksi]	Tensile Strength MPa [ksi]	Elongation [%]	Charpy V-Notch J [ft·lbf] -40°C [40°F]	Charpy V-Notch J [ft·lbf] -51°C [60°F]
Requirements AWS A5.28: ER100S-G As-Welded with 90% Ar/10% CO ₂	Not Specified	690 (100) min	Not Specified	Not Specified	Not Specified
Typical Results⁽²⁾ As-Welded with 90% Ar/10% CO ₂	709 (103)	802 (116)	21	86 (64)	85 (63)
Stress Relieved 1 hr. @ 621°C [1150°F] with 90% Ar/10% CO ₂	627 (91)	723 (105)	25	113 (83)	100 (73)

WIRE COMPOSITION – As Required per AWS A5.28

	%C	%Mn	%Si	%Ni
Requirements - AWS A5.28: ER100S-G	–	–	–	(A)
Typical Results⁽²⁾	0.10	1.55	0.57	0.88
	%Mo	%Cr	%S	%P
Requirements - AWS A5.28: ER100S-G	(A)	(A)	–	–
Typical Results⁽²⁾	0.47	0.28	< 0.005	0.01
	%V	%Al	%Cu	
Requirements - AWS A5.28: ER100S-G	–	–	–	
Typical Results⁽²⁾	< 0.003	0.003	0.12	

⁽¹⁾ Measured with a 0.2% offset. ⁽²⁾ See test results disclaimer

(A) Must have the minimum of one or more of the following: 0.50% Ni, 0.30% Cr, or 0.20% Mo.

SUPERARC® LA-75

Low Alloy Steel · AWS ER80-Ni1

KEY FEATURES

- Q2 Lot® - Certificates showing actual wire composition and mechanical properties available online
- Available as Batch Managed Inventory
- Capable of producing weld deposits with 550 MPa (80 ksi) tensile strength
- High toughness at low temperatures with a nominal 1% Ni or less
- MicroGuard® Ultra provides superior feeding and arc stability
- Supports short-circuiting, globular, axial spray and pulsed spray transfer

WELDING POSITIONS

All

CONFORMANCES

AWS A5.28:	ER80S-Ni1
ASME SFA-A5.28:	ER80S-Ni1
AWS A5.17:	ENiK
ABS:	ER80S-Ni1
CWB/CSA W48-06:	ER55S-Ni1 (ER80S-Ni1)
EN ISO 14341-B:	G 55A 4 M13 SN2

TYPICAL APPLICATIONS

- ASTM A588 weathering steel requiring good atmospheric corrosion resistance
- NACE applications
- Nuclear power plant construction and maintenance

ASME IX QUALIFICATION

ASME IX Qualification:	QW432 F-No 6, QW442 A-No 10
------------------------	--------------------------------

DIAMETERS / PACKAGING

Diameter in (mm)	33 lb (15 kg) Plastic Spool
0.035 (0.9)	ED033949

MECHANICAL PROPERTIES⁽¹⁾ – As Required per AWS A5.28

	Yield Strength ⁽²⁾ MPa (ksi)	Tensile Strength MPa (ksi)	Elongation %	Charpy V-Notch J (ft-lbf)		
				@ -29°C (-20°F)	@ -45°C (-50°F)	@ -57°C (-70°F)
Requirements - AWS ER80S-Ni1 As-Welded with 98% Ar/2% O ₂	470 (68) min	550 (80) min	24 min	Not Specified	27 (20) min	Not Specified
Typical Results⁽³⁾ As-Welded with 90% Ar/10% CO ₂ Stress Relieved 1 hr. @ 621°C (1150° F)	475 (69) 450 (65)	580 (84) 565 (82)	28 32	119 (88) - -	82 (60) 127 (93)	35 (26) 112 (82)
As-Welded with 75% Ar/25% CO ₂ Stress Relieved 1 hr. @ 621°C (1150° F)	495 (72) 440 (64)	595 (86) 560 (81)	27 31	49 (36) 127 (94)	54 (40) 114 (84)	- - 54 (40)
As-Welded with 98% Ar/2% O ₂	490 (71)	580 (84)	30	- -	103 (76)	- -

WIRE COMPOSITION – As Required per AWS A5.28

	%C	%Mn	%Si	%Ni	%Cr
Requirements - AWS ER80S-Ni1	0.12 max	1.25 max	0.40-0.80	0.80-1.10	0.15 max
Typical Results⁽³⁾	0.07-0.08	0.94-1.04	0.54-0.58	0.88-0.98	≤ 0.04
	%Mo	%S	%P	%V	%Cu (Total) ⁽⁴⁾
Requirements - AWS ER80S-Ni1	0.35 max	0.025 max	0.025 max	0.05 max	0.35 max
Typical Results⁽³⁾	≤ 0.02	0.007 - 0.010	0.005 - 0.010	< 0.01	0.16 - 0.21

TYPICAL OPERATING PROCEDURES

Diameter, Polarity Shielding Gas	CTWD ⁽⁵⁾ mm (in)	Wire Feed Speed m/min (in/min)	Voltage (volts)	Approx. Current (amps)	Melt-Off Rate kg/hr (lb/hr)
0.035 in (0.9 mm), DC+					
Short Circuit Transfer 75% Ar/25% CO ₂	9-12 (3/8-1/2)	2.5 (100)	17	80	0.7 (1.6)
		3.8 (150)	18	120	1.1 (2.4)
		6.4 (250)	22	175	1.8 (4.0)
Spray Transfer 90% Ar/10% CO ₂	12-19 (1/2-3/4)	9.5 (375)	23	195	2.7 (6.0)
		12.7 (500)	29	230	3.6 (8.0)
		15.2 (600)	30	275	4.4 (9.6)

⁽¹⁾Typical all weld metal. ⁽²⁾Measured with 0.2% offset. ⁽³⁾See test results disclaimer ⁽⁴⁾Copper due to any coating on the electrode plus the copper content of the filler metal itself, shall not exceed the stated 0.50% max.

⁽⁵⁾CTWD (Contact Tip to Work Distance). Subtract 1/4 in (6.4 mm) to calculate Electrical Stickout.

NOTE: For 100% CO₂ procedures, add 1 to 2 volts for short circuit transfer and 2 to 3 volts for globular transfer.

BLUE MAX[®] MIG 308L N

Stainless Steel · AWS ER308/ER308L

KEY FEATURES

- Q2 Lot[®] - Certificate showing actual wire composition and calculated ferrite number (FN) available online
- Available as Batch Managed Inventory
- "N" Designator - cobalt restriction of 0.05% max
- Meets the low Si levels typically required in the nuclear industry
- Meets the low cobalt levels typically required in the nuclear industry.
- Prior to using this material for ASME Boiler and Pressure Vessel Code Section III applications, please contact the Lincoln Electric Specials Department to receive a Certified Material Test Report (CMTR) which meets all requirements of NCA-3860
- Composition controlled to meet nuclear and power generation requirements
- Each spool is identified with AWS classification and LOT number

CONFORMANCES

AWS A5.9: ER308, ER308L

ASME SFA-A5.9: ER308, ER308L

TYPICAL APPLICATIONS

- Nuclear power plant components, maintenance and construction
- Power and process industry related piping
- Pressure Vessels

ASME IX QUALIFICATION

ASME IX Qualification: QW432 F-No 6, QW442 A-No 8

WELDING POSITIONS

All

DIAMETERS / PACKAGING

Diameter in (mm)	33 lb (15 kg) Steel Spool
0.035 (0.9)	ED033848
0.045 (1.1)	ED033849

MECHANICAL PROPERTIES⁽¹⁾ – As Required per AWS A5.9

	Yield Strength ⁽²⁾ MPa (ksi)	Tensile Strength MPa (ksi)	Elongation %	Ferrite Number
Requirements - AWS ER308/308L	Not Specified			
Typical Results ⁽³⁾ - As-Welded	430 (62)	615 (89)	37	13

WIRE COMPOSITION – As Required per AWS A5.9

	%C	%Cr	%Ni	%Mo	%Mn
Requirements - AWS ER308L	0.03 ^(a) max	19.5 - 22.0	9.0 -11.0	0.75 max	1.0 - 2.5
Typical Results^(a)	0.02	20.2	9.2	0.03	1.6
	%Si	%P	%S	%Cu	Total Others
Requirements - AWS ER308L	0.30 - 0.65	0.03 max	0.03 max	0.75 max	0.50 max
Typical Results^(a)	0.44	0.02	0.02	0.11	0.03

TYPICAL OPERATING PROCEDURES

Diameter, Polarity Shielding Gas	CTWD ^(d) mm (in)	Wire Feed Speed m/min (in/min)	Voltage (Volts)	Approx. Current (Amps)	Deposition Rate kg/hr (lb/hr)	
Short Circuit Transfer						
0.035 in (0.9 mm), DC+ 90% He / 7-1/2% Ar / 2-1/2% CO ₂	13 (1/2)	3.0 (120)	19-20	55	0.9 (2.0)	
	13 (1/2)	4.6 (180)	19-20	85	1.4 (3.0)	
	13 (1/2)	5.8 (230)	20-21	105	1.8 (3.9)	
	13 (1/2)	7.6 (300)	20-21	125	2.3 (5.0)	
	13 (1/2)	8.9 (350)	21-22	140	2.7 (5.9)	
	13 (1/2)	10.2 (400)	22-23	160	3.1 (6.7)	
0.045 in (1.1 mm), DC+ 90% He / 7-1/2% Ar / 2-1/2% CO ₂	13 (1/2)	2.5 (100)	19-20	100	1.1 (2.8)	
	13 (1/2)	3.2 (125)	19-20	120	1.5 (3.5)	
	13 (1/2)	3.8 (150)	21	135	1.7 (4.2)	
	13 (1/2)	4.4 (175)	21	140	2.0 (4.8)	
	13 (1/2)	5.6 (220)	22	170	2.6 (6.1)	
	13 (1/2)	6.4 (250)	22-23	175	2.9 (6.9)	
0.045 in (1.1 mm), DC+ 98% Ar/2% O ₂	13 (1/2)	10.2 (400)	22	180	3.1 (6.7)	
	13 (1/2)	10.8 (425)	23	190	3.3 (7.1)	
	13 (1/2)	11.4 (450)	23	200	3.5 (7.5)	
	13 (1/2)	12.1 (475)	23	210	3.7 (8.0)	
	0.045 in (1.1 mm), DC+ 98% Ar/2% O ₂	13 (1/2)	6.1 (240)	23	195	2.8 (6.6)
		13 (1/2)	6.6 (260)	24	230	3.0 (7.2)
13 (1/2)		7.6 (300)	24	240	3.5 (8.3)	
13 (1/2)		8.3 (325)	25	250	3.8 (9.0)	
13 (1/2)		9.1 (360)	25	260	4.2 (10.0)	

^(a)Typical all weld metal. ^(b)Measured with 0.2% offset. ^(c)See test results disclaimer ^(d)CTWD (Contact Tip to Work Distance). Subtract 1/4 in (6.4 mm) to calculate Electrical Stickout.
NOTE: For 100% CO₂ procedures, add 1 to 2 volts for short circuit transfer and 2 to 3 volts for globular transfer.

IMPORTANT: SPECIAL VENTILATION AND/OR EXHAUST REQUIRED

Fumes from the normal use of some welding products can contain significant quantities of components - such as chromium and manganese - which can lower the 5.0 mg/m³ maximum exposure guideline for general welding fume. BEFORE USE, READ AND UNDERSTAND THE SAFETY DATA SHEET (SDS) FOR THIS PRODUCT AND SPECIFIC INFORMATION PRINTED ON THE PRODUCT CONTAINER.

BLUE MAX® MIG 309L N

Stainless Steel · AWS ER309/ER309L

KEY FEATURES

- Q2 Lot® - Certificate showing actual wire composition and calculated ferrite number (FN) available online
- Available as Batch Managed Inventory
- "N" Designator - cobalt restriction of 0.05% max
- Meets the low Si levels typically required in the nuclear industry
- Meets the low cobalt levels typically required in the nuclear industry.
- Prior to using this material for ASME Boiler and Pressure Vessel Code Section III applications, please contact the Lincoln Electric Specials Department to receive a Certified Material Test Report (CMTR) which meets all requirements of NCA-3860
- Capable of meeting drop weight testing requirements as commonly required for nuclear applications
- Composition controlled to meet nuclear and power generation requirements
- Each spool is identified with AWS classification and LOT number

CONFORMANCES

AWS A5.9: ER309, ER309L

ASME SFA-A5.9: ER309, ER309L

TYPICAL APPLICATIONS

- Nuclear power plant components, maintenance and construction
- Power and process industry related piping
- Pressure Vessels

ASME IX QUALIFICATION

ASME IX Qualification: QW432 F-No 6,
QW442 A-No 8

WELDING POSITIONS

All

DIAMETERS / PACKAGING

Diameter in (mm)	33 lb (15 kg) Steel Spool
0.035 (0.9)	ED033850
0.045 (1.1)	ED033851

MECHANICAL PROPERTIES⁽¹⁾ – As Required per AWS A5.9

	Yield Strength ⁽²⁾ MPa (ksi)	Tensile Strength MPa (ksi)	Elongation %	Ferrite Number
Requirements - AWS ER309Si, ER309LSi	Not Specified			
Typical Results⁽³⁾ - As-Welded	450 (65)	595 (86)	35	14

WIRE COMPOSITION – As Required per AWS A5.9

	%C	%Cr	%Ni	%Mo	%Mn
Requirements - AWS ER309L	0.03 ^(a) max	23.0 - 25.0	12.0 - 14.0	0.75 max	1.0 - 2.5
Typical Results^(a)	0.02	23.7	13.9	0.04	1.8
	%Si	%P	%S	%Cu	Total Others
Requirements - AWS ER309L	0.30 - 0.65	0.03 max	0.03 max	0.75 max	0.50 max
Typical Results^(a)	0.51	0.02	0.01	0.05	0.06

TYPICAL OPERATING PROCEDURES

Diameter, Polarity Shielding Gas	CTWD ^(d) mm (in)	Wire Feed Speed m/min (in/min)	Voltage (Volts)	Approx. Current (Amps)	Deposition Rate kg/hr (lb/hr)
Short Circuit Transfer					
0.035 in (0.9 mm), DC+ 90% He / 7-1/2% Ar / 2-1/2% CO ₂	13 (1/2)	3.0 (120)	19-20	55	0.9 (2.0)
	13 (1/2)	4.6 (180)	19-20	85	1.4 (3.0)
	13 (1/2)	5.8 (230)	20-21	105	1.8 (3.9)
	13 (1/2)	7.6 (300)	20-21	125	2.3 (5.0)
	13 (1/2)	8.9 (350)	21-22	140	2.7 (5.9)
	13 (1/2)	10.2 (400)	22-23	160	3.1 (6.7)
0.045 in (1.1 mm), DC+ 90% He / 7-1/2% Ar / 2-1/2% CO ₂	13 (1/2)	2.5 (100)	19-20	100	1.1 (2.8)
	13 (1/2)	3.2 (125)	19-20	120	1.5 (3.5)
	13 (1/2)	3.8 (150)	21	135	1.7 (4.2)
	13 (1/2)	4.4 (175)	21	140	2.0 (4.8)
	13 (1/2)	5.6 (220)	22	170	2.6 (6.1)
	13 (1/2)	6.4 (250)	22-23	175	2.9 (6.9)
13 (1/2)	7.0 (275)	22-23	185	3.2 (7.6)	
Axial Spray Transfer					
0.035 in (0.9 mm), DC+ 98% Ar/2% O ₂	13 (1/2)	10.2 (400)	22	180	3.1 (6.7)
	13 (1/2)	10.8 (425)	23	190	3.3 (7.1)
	13 (1/2)	11.4 (450)	23	200	3.5 (7.5)
	13 (1/2)	12.1 (475)	23	210	3.7 (8.0)
0.045 in (1.1 mm), DC+ 98% Ar/2% O ₂	13 (1/2)	6.1 (240)	23	195	2.8 (6.6)
	13 (1/2)	6.6 (260)	24	230	3.0 (7.2)
	13 (1/2)	7.6 (300)	24	240	3.5 (8.3)
	13 (1/2)	8.3 (325)	25	250	3.8 (9.0)
	13 (1/2)	9.1 (360)	25	260	4.2 (10.0)

^(a)Typical all weld metal. ^(b)Measured with 0.2% offset. ^(c)See test results disclaimer ^(d)CTWD (Contact Tip to Work Distance). Subtract 1/4 in (6.4 mm) to calculate Electrical Stickout.
NOTE: For 100% CO₂ procedures, add 1 to 2 volts for short circuit transfer and 2 to 3 volts for globular transfer.

IMPORTANT: SPECIAL VENTILATION AND/OR EXHAUST REQUIRED

Fumes from the normal use of some welding products can contain significant quantities of components - such as chromium and manganese - which can lower the 5.0 mg/m³ maximum exposure guideline for general welding fume.
BEFORE USE, READ AND UNDERSTAND THE SAFETY DATA SHEET (SDS) FOR THIS PRODUCT AND SPECIFIC INFORMATION PRINTED ON THE PRODUCT CONTAINER.

BLUE MAX® MIG 316L N

Stainless Steel · AWS ER316/ER316L

KEY FEATURES

- Q2 Lot® - Certificate showing actual wire composition and calculated ferrite number (FN) available online
- Available as Batch Managed Inventory
- "N" Designator - cobalt restriction of 0.05% max
- Meets the low Si levels typically required in the nuclear industry
- Meets the low cobalt levels typically required in the nuclear industry.
- Prior to using this material for ASME Boiler and Pressure Vessel Code Section III applications, please contact the Lincoln Electric Specials Department to receive a Certified Material Test Report (CMTR) which meets all requirements of NCA-3860
- Composition controlled to meet nuclear and power generation requirements
- Each spool is identified with AWS classification and LOT number

CONFORMANCES

AWS A5.9: ER316, ER316L

ASME SFA-A5.9: ER316, ER316L

TYPICAL APPLICATIONS

- Nuclear power plant components, maintenance and construction
- Power and process industry related piping
- Pressure Vessels

ASME IX QUALIFICATION

ASME IX Qualification: QW432 F-No 6, QW442 A-No 8

WELDING POSITIONS

All

DIAMETERS / PACKAGING

Diameter in (mm)	33 lb (15 kg) Steel Spool
0.035 (0.9)	ED033852
0.045 (1.1)	ED033853

MECHANICAL PROPERTIES⁽¹⁾ – As Required per AWS A5.9

	Yield Strength ⁽²⁾ MPa (ksi)	Tensile Strength MPa (ksi)	Elongation %	Ferrite Number
Requirements - AWS ER316Si, ER316LSi	Not Specified			
Typical Results ⁽³⁾ - As-Welded	405 (59)	560 (81)	40	10

WIRE COMPOSITION – As Required per AWS A5.9

	%C	%Cr	%Ni	%Mo	%Mn
Requirements - AWS ER316L	0.03 ^(a) max	18.0 - 20.0	11.0 - 14.0	2.0 - 3.0	1.0 - 2.5
Typical Results^(b)	0.02	18.7	11.8	2.3	1.7
	%Si	%P	%S	%Cu	Total Others
Requirements - AWS ER316L	0.30 - 0.65	0.03 max	0.03 max	0.75 max	0.50 max
Typical Results^(b)	0.52	0.02	0.01	0.10	0.30

TYPICAL OPERATING PROCEDURES

Diameter, Polarity Shielding Gas	CTWD ^(d) mm (in)	Wire Feed Speed m/min (in/min)	Voltage (Volts)	Approx. Current (Amps)	Deposition Rate kg/hr (lb/hr)
Short Circuit Transfer					
0.035 in (0.9 mm), DC+ 90% He / 7-1/2% Ar / 2-1/2% CO ₂	13 (1/2)	3.0 (120)	19-20	55	0.9 (2.0)
	13 (1/2)	4.6 (180)	19-20	85	1.4 (3.0)
	13 (1/2)	5.8 (230)	20-21	105	1.8 (3.9)
	13 (1/2)	7.6 (300)	20-21	125	2.3 (5.0)
	13 (1/2)	8.9 (350)	21-22	140	2.7 (5.9)
	13 (1/2)	10.2 (400)	22-23	160	3.1 (6.7)
0.045 in (1.1 mm), DC+ 90% He / 7-1/2% Ar / 2-1/2% CO ₂	13 (1/2)	2.5 (100)	19-20	100	1.1 (2.8)
	13 (1/2)	3.2 (125)	19-20	120	1.5 (3.5)
	13 (1/2)	3.8 (150)	21	135	1.7 (4.2)
	13 (1/2)	4.4 (175)	21	140	2.0 (4.8)
	13 (1/2)	5.6 (220)	22	170	2.6 (6.1)
	13 (1/2)	6.4 (250)	22-23	175	2.9 (6.9)
13 (1/2)	7.0 (275)	22-23	185	3.2 (7.6)	
Axial Spray Transfer					
0.035 in (0.9 mm), DC+ 98% Ar/2% O ₂	13 (1/2)	10.2 (400)	22	180	3.1 (6.7)
	13 (1/2)	10.8 (425)	23	190	3.3 (7.1)
	13 (1/2)	11.4 (450)	23	200	3.5 (7.5)
	13 (1/2)	12.1 (475)	23	210	3.7 (8.0)
0.045 in (1.1 mm), DC+ 98% Ar/2% O ₂	13 (1/2)	6.1 (240)	23	195	2.8 (6.6)
	13 (1/2)	6.6 (260)	24	230	3.0 (7.2)
	13 (1/2)	7.6 (300)	24	240	3.5 (8.3)
	13 (1/2)	8.3 (325)	25	250	3.8 (9.0)
	13 (1/2)	9.1 (360)	25	260	4.2 (10.0)

^(a)Typical all weld metal. ^(b)Measured with 0.2% offset. ^(c)See test results disclaimer. ^(d)CTWD [Contact Tip to Work Distance]. Subtract 1/4 in [6.4 mm] to calculate Electrical Stickout.
NOTE: For 100% CO₂ procedures, add 1 to 2 volts for short circuit transfer and 2 to 3 volts for globular transfer.

IMPORTANT: SPECIAL VENTILATION AND/OR EXHAUST REQUIRED

Fumes from the normal use of some welding products can contain significant quantities of components - such as chromium and manganese - which can lower the 5.0 mg/m³ maximum exposure guideline for general welding fume. BEFORE USE, READ AND UNDERSTAND THE SAFETY DATA SHEET (SDS) FOR THIS PRODUCT AND SPECIFIC INFORMATION PRINTED ON THE PRODUCT CONTAINER.

BLUE MAX® LNM 4462 N

Stainless Steel · AWS ER2209

KEY FEATURES

- Q2 Lot® - Certificate showing actual wire composition and calculated ferrite number (FN) available online
- Available as Batch Managed Inventory
- "N" Designator - cobalt restriction of 0.05% max
- Premium performance and quality
- Designed for joining duplex stainless steels
- Provides high resistance to general corrosion, pitting and stress corrosion
- Composition is controlled to produce consistent mechanical properties
- Prior to using this material for ASME Boiler and Pressure Vessel Code Section III applications, please contact the Lincoln Electric Specials Department to receive a Certified Material Test Report (CMTR) which meet all requirements of NCA-3860

CONFORMANCES

AWS A5.9-93: ER2209
 ASME SFA-A5.9: ER2209

TYPICAL APPLICATIONS

- Nuclear power plant construction and maintenance
- Alloy 2205: UNS S31803, UNS S31500
- Alloy 2304: UNS S32304, UNS S31200
- Air pollution control systems for coal fired power plants
- Power and process industry components and piping
- Pressure Vessels

ASME IX QUALIFICATION

ASME IX Qualification: QW432 F-No 6,
 QW442 A-No 8

WELDING POSITIONS

All

DIAMETERS / PACKAGING

Diameter in (mm)	33 lb (15 kg) Plastic Spool
0.035 (0.9)	ED033955
0.045 (1.2)	ED033956

MECHANICAL PROPERTIES⁽¹⁾ – As Required per AWS A5.9

	Yield Strength ⁽²⁾ MPa (ksi)	Tensile Strength MPa (ksi)	Elongation %	Charpy V-Notch J (ft-lbf) @ -40°C (-40°F)
Requirements - AWS ER2209	Not Specified			
Typical Results ⁽³⁾ As-Welded with 98% Ar / 2% CO ₂	625 (91)	810 (118)	28	105 (78)

WIRE COMPOSITION⁽¹⁾ – As Required per AWS A5.9

	%C	%Cr	%Ni	%Mo	%Mn
Requirements - AWS ER2209	0.030 max	21.5-23.5	7.5-9.5	2.5-3.5	0.5-2.0
Typical Results ⁽³⁾	0.018	22.7	8.5	3.0	1.5
	%Si	%P	%S	%Cu	%N
Requirements - AWS ER2209	0.90 max	0.03 max	0.03 max	0.75 max	0.08-0.20
Typical Results ⁽³⁾	0.45	0.03	0.03	0.30	0.15

⁽¹⁾Typical all weld metal. ⁽²⁾Measured with 0.2% offset. ⁽³⁾See test results disclaimer.

IMPORTANT: SPECIAL VENTILATION AND/OR EXHAUST REQUIRED

Fumes from the normal use of some welding products can contain significant quantities of components - such as chromium and manganese - which can lower the 5.0 mg/m³ maximum exposure guideline for general welding fume. BEFORE USE, READ AND UNDERSTAND THE SAFETY DATA SHEET (SDS) FOR THIS PRODUCT AND SPECIFIC INFORMATION PRINTED ON THE PRODUCT CONTAINER.

LINCOLN® ER100S-1

Mild Steel · AWS ER100S-1

KEY FEATURES

- A low carbon, high manganese wire with nickel and molybdenum designed to weld high strength steels such as HY-80 and HSLA-80
- Delivers yield strength greater than 690 MPa (100 ksi)
- Capable of producing welds with 690 MPa (100 ksi) tensile strength
- Prior to using this material for ASME Boiler and Pressure Vessel Code Section III applications, please contact the Lincoln Electric Specials Department to receive a Certified Material Test Report (CMTR) which meets all requirements of NCA-3860
- Product is marked every 4 in. (101.6 mm) with AWS classification and LOT number for easy identification

WELDING POSITIONS

All

CONFORMANCES

AWS A5.28:	ER100S-1, ER110S-1
ASME SFA-A5.28:	ER100S-1, ER110S-1
MIL-E-23765/2:	MIL-100S-1

TYPICAL APPLICATIONS

- HY-80 base material
- ASTM A514, A543, A724 and A782 quenched and tempered plate
- Various heat input conditions
- Military low alloy applications
- Nuclear Steam Generators and other components

ASME IX QUALIFICATION

ASME IX Qualification:	QW432 F-No 6
	QW432 A-No 10

DIAMETERS / PACKAGING

Diameter in (mm)	10 lb (4.5 kg) Carton
3/32 (2.4)	ED034097
1/8 (3.2)	ED034098

WIRE COMPOSITION - As Required per AWS A5.28

	%C	%Mn	%Si	%Ni	%Mo
Requirements - AWS ER100S-1	0.08 max	1.25-1.80	0.20-0.55	1.40-2.10	0.25-0.55
Typical Results ⁽¹⁾	0.05-0.06	1.63-1.69	0.46-0.50	1.88-1.96	0.43-0.45
	%Cr	%S	%P	%V	%Al
Requirements - AWS ER100S-1	0.30 max	0.010 max	0.010 max	0.05 max	0.10 max
Typical Results ⁽¹⁾	0.04-0.06	0.002-0.005	0.005-0.009	≤ 0.01	≤ 0.01
	%Ti	%Zr	%Cu	Total Others	
Requirements - AWS ER100S-1	0.10 max	0.10 max	0.25 max	0.50 max	
Typical Results ⁽¹⁾	0.03-0.04	≤ 0.01	0.11-0.14	-	

⁽¹⁾See test results disclaimer

IMPORTANT: SPECIAL VENTILATION AND/OR EXHAUST REQUIRED

Fumes from the normal use of some welding products can contain significant quantities of components - such as chromium and manganese - which can lower the 5.0 mg/m³ maximum exposure guideline for general welding fume. BEFORE USE, READ AND UNDERSTAND THE SAFETY DATA SHEET (SDS) FOR THIS PRODUCT AND SPECIFIC INFORMATION PRINTED ON THE PRODUCT CONTAINER.

LINCOLN® ER308/308L N

Stainless Steel · AWS ER308/ER308L

KEY FEATURES

- Q2 Lot® - Certificate showing actual wire composition and calculated ferrite number (FN) available online
- "N" Designator - cobalt restriction of 0.05% max
- Available as Batch Managed Inventory
- Use on base metals of similar composition
- Meets the low cobalt levels typically required in the nuclear industry
- Dual classification ensures the maximum carbon content is 0.03%
- 0.03% carbon content increases resistance to intergranular corrosion
- Prior to using this material for ASME Boiler and Pressure Vessel Code Section III applications, please contact the Lincoln Electric Specials Department to receive a Certified Material Test Report (CMTR) which meets all requirements of NCA-3860
- Product is marked every 4 in. (101.6 mm) with AWS classification and LOT number for easy identification

CONFORMANCES

AWS A5.9: ER308, ER308L
 ASME SFA-A5.9: ER308, ER308L

TYPICAL APPLICATIONS

- Nuclear power plant components, maintenance and construction
- Sheet metal on the corresponding stainless steel base metals
- High pressure piping and tubing
- Pressure Vessels

ASME IX QUALIFICATION

ASME IX Qualification: QW432 F-No 6, QW442 A-No 8

WELDING POSITIONS

All

DIAMETERS / PACKAGING

Diameter in (mm)	10 lb (4.5 kg) Plastic Tube 30 lb (13.6 kg) Master
3/32 (2.4)	ED033854
1/8 (3.2)	ED033855

WIRE COMPOSITION – As Required per AWS A5.9

	%C ⁽¹⁾	%Cr	%Ni	%Mo	%Mn
Requirements - AWS ER308L	0.03max	19.5 - 22.0	9.0 -11.0	0.75 max	1.0 - 2.5
Typical Results ⁽¹⁾	0.02	20.2	9.2	0.03	1.6
	%Si	%P	%S	%Cu	Total Others
Requirements - AWS ER308L	0.30 - 0.65	0.03 max	0.03 max	0.75 max	0.50 max
Typical Results ⁽¹⁾	0.44	0.02	0.02	0.11	0.03

⁽¹⁾See test results disclaimer ⁽²⁾Requirements for ER308 is 0.08% max. carbon.

IMPORTANT: SPECIAL VENTILATION AND/OR EXHAUST REQUIRED

Fumes from the normal use of some welding products can contain significant quantities of components - such as chromium and manganese - which can lower the 5.0 mg/m³ maximum exposure guideline for general welding fume. BEFORE USE, READ AND UNDERSTAND THE SAFETY DATA SHEET (SDS) FOR THIS PRODUCT AND SPECIFIC INFORMATION PRINTED ON THE PRODUCT CONTAINER.

LINCOLN® ER309/309L N

Stainless Steel · AWS ER309/ER309L

KEY FEATURES

- Q2 Lot® - Certificate showing actual wire composition and calculated ferrite number (FN) available online
- Available as Batch Managed Inventory
- "N" Designator - cobalt restriction of 0.05% max
- Use for welding dissimilar alloys in wrought or cast form
- Meets the low cobalt levels typically required in the nuclear industry
- Occasionally used for welding "18-8" base metals when severe corrosion conditions exist or dissimilar metals
- 0.03% carbon content increases resistance to intergranular corrosion
- Prior to using this material for ASME Boiler and Pressure Vessel Code Section III applications, please contact the Lincoln Electric Specials Department to receive a Certified Material Test Report (CMTR) which meets all requirements of NCA-3860
- Product is marked every 4 in. (101.6 mm) with AWS classification and LOT number for easy identification

CONFORMANCES

AWS A5.9: ER309, ER309L
ASME SFA-A5.9: ER309, ER309L

TYPICAL APPLICATIONS

- Nuclear power plant components, maintenance and construction
- Sheet metal on the corresponding stainless steel base metals
- High pressure piping and tubing
- Pressure Vessels

ASME IX QUALIFICATION

ASME IX Qualification: QW432 F-No 6, QW442 A-No 8

WELDING POSITIONS

All

DIAMETERS / PACKAGING

Diameter in (mm)	10 lb (4.5 kg) Plastic Tube 30 lb (13.6 kg) Master
3/32 (2.4)	ED033856
1/8 (3.2)	ED033857

WIRE COMPOSITION – As Required per AWS A5.9

	%C ⁽²⁾	%Cr	%Ni	%Mo	%Mn
Requirements - AWS ER309L	0.03 max	23.0 - 25.0	12.0 - 14.0	0.75 max	1.0 - 2.5
Typical Results⁽¹⁾	0.02	23.7	13.9	0.04	1.8
	%Si	%P	%S	%Cu	Total Others
Requirements - AWS ER309L	0.30 - 0.65	0.03 max	0.03 max	0.75 max	0.50 max
Typical Results⁽¹⁾	0.51	0.02	0.01	0.05	0.06

⁽¹⁾See test results disclaimer ⁽²⁾Requirements for ER309 is 0.12% max. carbon.

IMPORTANT: SPECIAL VENTILATION AND/OR EXHAUST REQUIRED

Fumes from the normal use of some welding products can contain significant quantities of components - such as chromium and manganese - which can lower the 5.0 mg/m³ maximum exposure guideline for general welding fume. BEFORE USE, READ AND UNDERSTAND THE SAFETY DATA SHEET (SDS) FOR THIS PRODUCT AND SPECIFIC INFORMATION PRINTED ON THE PRODUCT CONTAINER.

BLUE MAX® LNT 4462 N

Stainless Steel · AWS ER2209

KEY FEATURES

- Q2 Lot® - Certificate showing actual wire composition and calculated ferrite number (FN) available online
- Available as Batch Managed Inventory
- "N" Designator - cobalt restriction of 0.05% max
- Premium performance and quality
- Designed for joining duplex stainless steels, such as type 2205, for applications with service temperatures up to 250°C (480°F) and down to -40°C (-40°F).
- Provides high resistance to general corrosion, pitting and stress corrosion
- Composition is controlled to produce consistent mechanical properties

CONFORMANCES

AWS A5.9: ER2209
 ASME SFA-A5.9: ER2209

TYPICAL APPLICATIONS

- Nuclear power plant construction and maintenance
- Alloy 2205: UNS S31803, UNS S31500
- Alloy 2304: UNS S32304, UNS S31200
- Air pollution control systems for coal fired power plants
- Power and process industry components and piping
- Pressure Vessels

WELDING POSITIONS

All

ASME IX QUALIFICATION

ASME IX Qualification: QW432 F-No 6,
 QW442 A-No 8

DIAMETERS / PACKAGING

Diameter in (mm)	10 lb (4.5 kg) Plastic Tube 30 lb (13.6 kg) Master
3/32 (2.4)	ED033957
1/8 (3.2)	ED033958

MECHANICAL PROPERTIES⁽¹⁾ – As Required per AWS A5.9

	Yield Strength ⁽²⁾ MPa (ksi)	Tensile Strength MPa (ksi)	Elongation %	Charpy V-Notch J (ft-lbf)	
				@ -20°C (-4°F)	@ -60°C (-75°F)
Requirements - AWS ER2209	Not Specified				
Typical Results ⁽³⁾ - As-Welded	600 (87)	800 (116)	28	60 (44)	45 (33)

WIRE COMPOSITION⁽¹⁾ – As Required per AWS A5.9

	%C	%Cr	%Ni	%Mo	%Mn
Requirements - AWS ER2209	0.030 max	21.5-23.5	7.5-9.5	2.5-3.5	0.5-2.0
Typical Results ⁽³⁾	0.018	22.7	8.5	3.0	1.5
	%Si	%P	%S	%Cu	%N
Requirements - AWS ER2209	0.90 max	0.03 max	0.03 max	0.75 max	0.08-0.20
Typical Results ⁽³⁾	0.50	0.03	0.03	0.30	0.15

⁽¹⁾Typical all weld metal. ⁽²⁾Measured with 0.2% offset. ⁽³⁾See test results disclaimer

IMPORTANT: SPECIAL VENTILATION AND/OR EXHAUST REQUIRED

Fumes from the normal use of some welding products can contain significant quantities of components - such as chromium and manganese - which can lower the 5.0 mg/m³ maximum exposure guideline for general welding fume. BEFORE USE, READ AND UNDERSTAND THE SAFETY DATA SHEET (SDS) FOR THIS PRODUCT AND SPECIFIC INFORMATION PRINTED ON THE PRODUCT CONTAINER.

SUPERARC® ORBITAL TIG L-52 N

Mild Steel · AWS ER70S-2

KEY FEATURES

- Ultra-clean surface treatment for porosity free welds
- Q2 Lot® - Certificate showing actual wire composition available online
- Available as Batch Managed Inventory
- "N" Designator - design modified to meet properties after stress relief
- A PLW product which has been treated to minimize weld defects that can be seen in the use of MIG wires for the automatic TIG process
- Provides a consistent and exceptionally stable arc for automatic TIG welding
- Contains zirconium, titanium, and aluminum in addition to silicon and manganese
- Produces x-ray quality welds over most surface conditions
- Recommended for TIG welding on all grades of steel
- Excellent choice for PWHT applications
- Each spool is identified with AWS classification and LOT number

CONFORMANCES

AWS A5: ER70S-2

TYPICAL APPLICATIONS

- Nuclear power plant construction and maintenance
- Power and process industry related piping
- Medium to heavy mill scale base material
- Robotic or hard automation

ASME IX QUALIFICATION

ASME IX Qualification: QW432 F-No 6, QW442 A-No 1

WELDING POSITIONS

All

DIAMETERS / PACKAGING

Diameter in (mm)	2 lb (1 kg) Plastic Spool 8 lb (3.6 kg) Master Carton	10 lb (4.5 kg) Plastic Spool
0.035 (0.9)	ED033947	ED033948

WIRE COMPOSITION⁽¹⁾ – As Required per AWS A5.18

	%C	%Mn	%S	%Si	%P	%Cu	%Cr
Requirements - AWS ER70S-2	0.07 max	0.90-1.40	0.035 max	0.40-0.70	0.0025 max	0.50 max	(1)
Typical Results⁽²⁾	0.04	1.08	0.005	0.55	0.0003	0.20	0.08
	%Ni	%Mo	%V	%Al	%Ti	%Zr	
Requirements - AWS ER70S-2	(1)	(1)	(1)	0.05-0.15	0.05-0.15	0.02-0.12	
Typical Results⁽²⁾	0.08	0.08	< 0.002	0.08	0.10	0.07	

⁽¹⁾Typical all weld metal. ⁽²⁾See test results disclaimer

SUPERARC® ORBITAL TIG L-56® N

Mild Steel · AWS ER70S-6

KEY FEATURES

- Ultra-clean surface treatment for porosity free welds
- Q2 Lot® - Certificate showing actual wire composition available online
- Available as Batch Managed Inventory
- "N" Designator - design modified to meet properties after stress relief
- A PLW product which has been treated to minimize weld defects that can be seen in the use of MIG wires for the automatic TIG process.
- Provides a consistent and exceptionally stable arc for automatic TIG welding
- High levels of manganese and silicon deoxidizers tolerate medium to heavy mill scale surfaces
- Excellent toe-wetting provides optimal bead appearance
- Each spool is identified with AWS classification and LOT number

CONFORMANCES

AWS A5: ER70S-6

TYPICAL APPLICATIONS

- Nuclear power plant construction and maintenance
- Power and process industry related piping
- Medium to heavy mill scale base material
- Robotic or hard automation

ASME IX QUALIFICATION

ASME IX Qualification: QW432 F-No 6, QW442 A-No 1

WELDING POSITIONS

All

DIAMETERS / PACKAGING

Diameter in (mm)	2 lb (1 kg) Plastic Spool 8 lb (3.6 kg) Master Carton	10 lb (4.5 kg) Plastic Spool
0.035 (0.9)	ED033840	ED033841

WIRE COMPOSITION⁽¹⁾ – As Required per AWS A5.18

	%C	%Mn	%Si	%S	%P
Requirements - AWS ER70S-6	0.06-0.15	1.40-1.85	0.80-1.15	0.035 max	0.025 max
Typical Results ⁽²⁾	0.08-0.09	1.42-1.60	0.81-0.87	0.006-0.010	0.004-0.010
	%Cr	%Ni	%Mo	%V	%Cu (Total) ⁽³⁾
Requirements - AWS ER70S-6	0.15 max	0.15 max	0.15 max	0.03 max	0.50 max
Typical Results ⁽²⁾	0.01-0.05	≤ 0.04	≤ 0.01	< 0.01	0.17-0.22

⁽¹⁾Typical all weld metal. ⁽²⁾See test results disclaimer ⁽³⁾Copper due to any coating on the electrode plus the copper content of the filler metal itself, shall not exceed the stated 0.50% max. †

BLUE MAX® ORBITAL TIG 308/308L N

Mild Steel · AWS ER308, 308L

KEY FEATURES

- Ultra-clean surface treatment for porosity free welds
- Q2 Lot® - Certificate showing actual wire composition and calculated ferrite number (FN) available online
- Batch Managed Inventory
- "N" Designate - design modified to meet special chemistry requirements
- 0.05% max Cobalt
- Prior to using this material for ASME Boiler and Pressure Vessel Code Section III applications, please contact Lincoln Electric Specials Department to receive a Certified Material Test Report (CMTR) which meet all requirements of NCA-3860

CONFORMANCES

AWS A5: ER308L

TYPICAL APPLICATIONS

- Nuclear Energy
- Thermal Energy
- Petroleum Processing
- Pressure Vessel
- Contractors
- Process Piping

SHIELDING GAS

100% Argon

WELDING POSITIONS

All

DIAMETERS / PACKAGING

Diameter in (mm)	2 lb (1 kg) Spool 8 lb (3.6 kg) Carton	10 lb (4.5 kg) Spool
0.035 (0.9)	ED034141	ED034143

WIRE COMPOSITION⁽¹⁾ – As Required per AWS A5.9

	%C	%Mn	%Si	%S	%P	%Cr
Requirements - AWS ER308/308L	0.03 max	1.0-2.5	0.30-0.65	0.03 max	0.03 max	19.5-22.0
Typical Results⁽²⁾	0.02	1.20	0.39	<0.01	0.02	20.20
	%Ni	%Mo	%Cu	%N	%Co	FN
Requirements - AWS ER308/308L	9.0-11.0	0.75 max	0.75 max	Not Specified	0.05 max	Not Required
Typical Results⁽²⁾	10.30	0.16	0.11	0.02	0.04	Not Required

⁽¹⁾Typical all weld metal. ⁽²⁾See test results disclaimer

BLUE MAX® ORBITAL TIG 309/309L N

Mild Steel · AWS ER309, 309L

KEY FEATURES

- Ultra-clean surface treatment for porosity free welds
- Q2 Lot® - Certificate showing actual wire composition and calculated ferrite number (FN) available online
- Batch Managed Inventory
- "N" Designate - design modified to meet special chemistry requirements
- 0.05% max Cobalt
- Prior to using this material for ASME Boiler and Pressure Vessel Code Section III applications, please contact Lincoln Electric Specials Department to receive a Certified Material Test Report (CMTR) which meet all requirements of NCA-3860

CONFORMANCES

AWS A5: ER309L

TYPICAL APPLICATIONS

- Nuclear Energy
- Thermal Energy
- Petroleum Processing
- Process Piping

SHIELDING GAS

100% Argon

WELDING POSITIONS

All

DIAMETERS / PACKAGING

Diameter in (mm)	2 lb (1 kg) Spool 8 lb (3.6 kg) Carton	10 lb (4.5 kg) Spool
0.035 (0.9)	ED034145	ED034147

WIRE COMPOSITION⁽¹⁾ – As Required per AWS A5.9

	%C	%Mn	%Si	%S	%P	%Cr
Requirements - AWS ER308/308L	0.03 max	1.0-2.5	0.30-0.65	0.03 max	0.03 max	23.0-25.0
Typical Results⁽²⁾	0.02	1.60	0.36	<0.01	0.02	23.80
	%Ni	%Mo	%Cu	%N	%Co	FN
Requirements - AWS ER308/308L	12.0-14.0	0.75 max	0.75 max	Not Specified	0.05 max	Not Required
Typical Results⁽²⁾	13.30	0.12	0.10	0.08	0.04	Not Required

⁽¹⁾Typical all weld metal. ⁽²⁾See test results disclaimer

BLUE MAX® ORBITAL TIG 316/316L N

Mild Steel · AWS ER316, 316L

KEY FEATURES

- Ultra-clean surface treatment for porosity free welds
- Q2 Lot® - Certificate showing actual wire composition and calculated ferrite number (FN) available online
- Batch Managed Inventory
- "N" Designate - design modified to meet special chemistry requirements
- 0.05% max Cobalt
- Prior to using this material for ASME Boiler and Pressure Vessel Code Section III applications, please contact Lincoln Electric Specials Department to receive a Certified Material Test Report (CMTR) which meet all requirements of NCA-3860

WELDING POSITIONS

All

CONFORMANCES

- AWS A5:** ER316, ER316L
ABS: ER316, ER316L
ISO: SS316L

TYPICAL APPLICATIONS

- Nuclear Energy
- Thermal Energy
- Petroleum Processing
- Process Piping

SHIELDING GAS

100% Argon

DIAMETERS / PACKAGING

Diameter in (mm)	2 lb (1 kg) Spool 8 lb (3.6 kg) Carton	10 lb (4.5 kg) Spool
0.035 (0.9)	ED034149	ED034151

WIRE COMPOSITION⁽¹⁾ – As Required per AWS A5.9

	%C	%Mn	%Si	%S	%P	%Cr
Requirements - AWS ER316/316L	0.03 max	1.0-2.5	0.30-0.65	0.03 max	0.03 max	18.0-20.0
Typical Results⁽²⁾	0.02	1.70	0.36	<0.01	0.01	19.70
	%Ni	%Mo	%Cu	%N	%Co	FN
Requirements - AWS ER316/316L	11.0-14.0	2.0-3.0	0.75 max	Not Specified	0.05 max	Not Required
Typical Results⁽²⁾	11.60	2.10	0.03	0.02	0.04	Not Required

⁽¹⁾Typical all weld metal. ⁽²⁾See test results disclaimer

SUPERARC® ORBITAL TIG AK-10™

Low Alloy Steel · AWS ER100S-G

KEY FEATURES

- Ultra-clean surface treatment for porosity free welds
- Capable of producing welds with 690 MPa (100 ksi) tensile strength
- Suitable for use where consumables with less than 1% Ni are required
- Batch Managed Inventory
- Precision layer wound

WELDING POSITIONS

All

CONFORMANCES

AWS A5: ER100S-G

TYPICAL APPLICATIONS

- NACE applications
- Oil tools
- Riser systems
- High-strength pipe

TYPICAL BASE METALS

HY-80 or HY-100 per MIL-S-16216, A514 Grade B or P, AISI 4130 or 8620, API X-70 or X-80

DIAMETERS / PACKAGING

Diameters in [mm]	10 lb (4.5kg) Plastic Spool	33 lb (15kg) Plastic Spool
0.035 (0.9)	ED035372	ED035373
0.045 (1.1)	ED035374	ED035375

WIRE COMPOSITION⁽¹⁾ – As Required per AWS A5.28

	%C	%Mn	%Si	%Ni	%Mo	%Cr	%S	%P	%V	%Al	%Cu
Requirements - AWS ER100S-G	–	–	–	(A)	(A)	(A)	–	–	–	–	–
Typical Results ⁽²⁾	0.10	1.55	0.57	0.88	0.47	0.28	< 0.005	0.01	< 0.003	0.003	0.12

(A) Must have the minimum of one or more of the following: 0.50% Ni, 0.30% Cr, or 0.20% Mo.

⁽²⁾Typical all weld metal. ⁽²⁾See test results disclaimer

LINCOLNWELD® MIL800-H™ & LA-84

Low Alloy Steel · AWS F9P6-EF3-F3-H2

KEY FEATURES

- Capable of exceeding AWS minimum requirement of 620 Mpa (90 ksi) tensile strength after 48 hours of stress relieving at 1100-1150°F.
- Capable of meeting drop weight testing requirements as commonly required for nuclear applications.
- Each coil is identified with AWS classification and LOT number.

TYPICAL APPLICATIONS

- Nuclear reactor vessels and other components

ASME IX QUALIFICATION

ASME IX Qualification: QW432 F-No 6

DIAMETERS / PACKAGING - FLUX

50 lb (22.7 kg)
Hermetically Sealed Foil Bag

ED035892

DIAMETERS / PACKAGING - WIRE

Diameter in (mm)	60 lb (27.2 kg) Coil
5/64 (2.0)	ED034211
3/32 (2.4)	ED031871
1/8 (3.2)	ED033323
5/32 (4.0)	ED034212

WIRE COMPOSITION⁽¹⁾ - As Required per AWS A5.23

	%C	%Mn	%Si	%Ni	%Mo	%S	%P	%Cu
Lincolnweld® LA-84	0.10-0.18	1.75-2.20	0.2	0.80-1.0	0.45-0.60	0.010-0.020	0.010-0.020	0.05-0.15

FLUX COMPOSITION⁽¹⁾

	%SiO ₂	%MnO	%MgO	%CaF ₂	%Na ₂ O	%Al ₂ O ₃	%CaO	%K ₂ O	%Metal Alloys
Lincolnweld® MIL800-H™	13	1	34	23	1	16	8	1	1 max

⁽¹⁾Typical all weld metal.

LINCOLNWELD® MIL800-H™ & LA-100

Low Alloy Steel · AWS F10A6-EM2-M2-H2

KEY FEATURES

- Capable of exceeding AWS minimum requirement of 620 Mpa [90 ksi] tensile strength after 48 hours of stress relieving at 1100-1150°F.
- Capable of meeting drop weight testing requirements as commonly required for nuclear applications.
- Each coil is identified with AWS classification and LOT number.

TYPICAL APPLICATIONS

- Nuclear reactor vessels and other components

ASME IX QUALIFICATION

ASME IX Qualification: QW432 F-No 6

DIAMETERS / PACKAGING - FLUX

50 lb [22.7 kg]
Hermetically Sealed Foil Bag

ED035892

DIAMETERS / PACKAGING - WIRE

Diameter in (mm)	60 lb [27.2 kg] Coil
1/16 [1.6]	ED010996
5/64 [2.0]	ED011002
3/32 [2.4]	ED010999
1/8 [3.2]	ED010998
5/32 [4.0]	EDS11001

WIRE COMPOSITION⁽¹⁾ - As Required per AWS A5.23

	%C	%Mn	%Si	%Cr	%Ni	%Mo	%Ti
Lincolnweld® LA-100	0.10	1.25-1.80	0.20-0.60	0.30	1.40-2.10	0.25-0.55	0.10
	%Zr	%Al	%V	%S	%P	%Cu	
Lincolnweld® LA-100	0.10	0.10	0.05	0.015	0.010	0.25	

FLUX COMPOSITION⁽¹⁾

	%SiO ₂	%MnO	%MgO	%CaF ₂	%Na ₂ O	%Al ₂ O ₃	%CaO	%K ₂ O	%Metal Alloys
Lincolnweld® MIL800-H™	13	1	34	23	1	16	8	1	1 max

⁽¹⁾Typical all weld metal.

LINCOLNWELD® P2007™ & 308/308L

Stainless Steel · AWS ER308/ER308L

KEY FEATURES

- Versatile design to weld several types of austenitic stainless steels
- Produces sound welds with excellent slag removal and bead appearance
- Designed combination to recover nearly all of the wire chromium in the deposit
- Balanced ferrite level for high resistance to hot cracking
- Low carbon content to reduce risk of sensitization of the weld

TYPICAL APPLICATIONS

- Nuclear reactor vessels and other components

ASME IX QUALIFICATION

ASME IX Qualification: QW432 F-No 6,
QW442 A-No 8

DIAMETERS / PACKAGING - WIRE

Diameter in (mm)	60 lb (27.2 kg) Coil
5/64 (2.0)	ED033147
3/32 (2.4)	ED033148
1/8 (3.2)	ED033149
5/32 (4.0)	ED033150

DIAMETERS / PACKAGING - FLUX

50 lb (22.7 kg) Plastic Bag
ED033159

MECHANICAL PROPERTIES⁽¹⁾ – As Required per AWS A5.9

	Yield Strength ⁽²⁾ MPa (ksi)	Tensile Strength MPa (ksi)	Elongation %	Ferrite Number
Requirements - AWS ER308, ER308L	Not Specified			
Typical Results ^(3,5) - As-Welded	380 (55)	565 (82)	42	15

WIRE & DEPOSIT COMPOSITION⁽¹⁾

	%C ⁽⁴⁾	%Cr	%Ni	%Mo	%Mn	%Si
Requirements - AWS ER308L	0.03 max	19.5 - 22.0	9.0 - 11.0	0.75 max	1.0 - 2.5	0.30 - 0.65
Typical Results ⁽³⁾						
Wire Composition	0.02	20.1	9.8	0.10	1.8	0.50
All Weld Metal Composition ⁽⁵⁾	0.02	19.0 - 19.5	9.8	0.10	1.5 - 1.9	0.50 - 0.80

TYPICAL OPERATING PROCEDURES

Diameter in (mm)	Wire Feed Speed m/min (in/min)	Voltage (volts)	Current (amps)
5/64 (2.0)	2.0-6.1 (80-240)	24-30	190-500
3/32 (2.4)	1.5-5.3 (60-210)	26-32	195-575
1/8 (3.2)	0.9-2.8 (35-110)	28-34	200-700
5/32 (4.0)	0.8-1.9 (30-75)	30-36	320-775

⁽¹⁾Typical all weld metal. ⁽²⁾Measured with 0.2% offset. ⁽³⁾See test results disclaimer. ⁽⁴⁾AWS Requirement for ER308 is 0.08% max. carbon.

⁽⁵⁾Results shown correspond with the recommended Lincolnweld® and Blue Max® fluxes listed above, but not required per AWS A5.9-93.

IMPORTANT: SPECIAL VENTILATION AND/OR EXHAUST REQUIRED

Fumes from the normal use of some welding products can contain significant quantities of components - such as chromium and manganese - which can lower the 5.0 mg/m³ maximum exposure guideline for general welding fume.
BEFORE USE, READ AND UNDERSTAND THE SAFETY DATA SHEET (SDS) FOR THIS PRODUCT AND SPECIFIC INFORMATION PRINTED ON THE PRODUCT CONTAINER.

LINCOLNWELD® P2007™ & 309/309L

Stainless Steel · AWS ER309/ER309L

KEY FEATURES

- Designed to weld stainless steel to mild or low alloy steel
- Produces sound welds with excellent slag removal and bead appearance
- Designed combination to recover nearly all of the wire chromium in the deposit
- Balanced ferrite level for high resistance to hot cracking
- Low carbon content to reduce risk of sensitization of the weld

TYPICAL APPLICATIONS

- Nuclear reactor vessels and other components

ASME IX QUALIFICATION

ASME IX Qualification: QW432 F-No 6,
QW442 A-No 8

DIAMETERS / PACKAGING - WIRE

Diameter in (mm)	60 lb (27.2 kg) Coil
5/64 (2.0)	ED033151
3/32 (2.4)	ED033152
1/8 (3.2)	ED033153
5/32 (4.0)	ED033154

DIAMETERS / PACKAGING - FLUX

50 lb (22.7 kg) Plastic Bag
ED033159

MECHANICAL PROPERTIES⁽¹⁾ – As Required per AWS A5.9

	Yield Strength ⁽²⁾ MPa (ksi)	Tensile Strength MPa (ksi)	Elongation %	Ferrite Number
Requirements - AWS ER309, ER309L	Not Specified			
Typical Results ^(3,4) - As-Welded	400 (58)	575 (83)	35	8

WIRE & DEPOSIT COMPOSITION⁽¹⁾ – As Required per AWS A5.9

	%C ⁽⁴⁾	%Cr	%Ni	%Mo	%Mn	%Si
Requirements - AWS ER309L	0.03 max	23.0 - 25.0	12.0 - 14.0	0.75 max	1.0 - 2.5	0.30 - 0.65
Typical Results ⁽⁵⁾						
Wire Composition	0.02	23.9	13.0	0.15	1.8	0.50
All Weld Metal Composition ⁽⁵⁾	0.03	23.1 - 23.6	13.0	0.15	1.5 - 2.0	0.50 - 0.80

TYPICAL OPERATING PROCEDURES

Diameter in (mm)	Wire Feed Speed m/min (in/min)	Voltage (volts)	Current (amps)
5/64 (2.0)	2.0-6.1 (80-240)	24-30	190-500
3/32 (2.4)	1.5-5.3 (60-210)	26-32	195-575
1/8 (3.2)	0.9-2.8 (35-110)	28-34	200-700
5/32 (4.0)	0.8-1.9 (30-75)	30-36	320-775

⁽¹⁾Typical all weld metal. ⁽²⁾Measured with 0.2% offset. ⁽³⁾See test results disclaimer ⁽⁴⁾AWS Requirement for ER309 is 0.12% max. carbon.

⁽⁵⁾Results shown correspond with the recommended Lincolnweld® and Blue Max® fluxes listed above, but not required per AWS A5.9-93.

IMPORTANT: SPECIAL VENTILATION AND/OR EXHAUST REQUIRED

Fumes from the normal use of some welding products can contain significant quantities of components - such as chromium and manganese - which can lower the 5.0 mg/m³ maximum exposure guideline for general welding fume.
BEFORE USE, READ AND UNDERSTAND THE SAFETY DATA SHEET (SDS) FOR THIS PRODUCT AND SPECIFIC INFORMATION PRINTED ON THE PRODUCT CONTAINER.

LINCOLNWELD® P2007™ & 316/316L

Stainless Steel · AWS ER316/ER316L

KEY FEATURES

- Designed to weld stainless steels for higher pitting corrosion resistance
- Produces sound welds with excellent slag removal and bead appearance
- Designed combination to recover nearly all of the wire chromium in the deposit
- Balanced ferrite level for high resistance to hot cracking
- Low carbon content to reduce risk of sensitization of the weld

TYPICAL APPLICATIONS

- Nuclear reactor vessels and other components

ASME IX QUALIFICATION

ASME IX Qualification: QW432 F-No 6,
QW442 A-No 8

DIAMETERS / PACKAGING - WIRE

Diameter in (mm)	60 lb (27.2 kg) Coil
5/64 [2.0]	ED033155
3/32 [2.4]	ED033156
1/8 [3.2]	ED033157
5/32 [4.0]	ED033158

DIAMETERS / PACKAGING - FLUX

50 lb (22.7 kg) Plastic Bag
ED033159

MECHANICAL PROPERTIES⁽¹⁾ – As Required per AWS A5.9

	Yield Strength ⁽²⁾ MPa (ksi)	Tensile Strength MPa (ksi)	Elongation %	Ferrite Number
Requirements - AWS ER316, ER316L	Not Specified			
Typical Results ^(3,5) - As-Welded	380 [55]	550 [80]	42	9

WIRE COMPOSITION⁽¹⁾ – As Required per AWS A5.9

	%C ⁽⁴⁾	%Cr	%Ni	%Mo	%Mn	%Si
Requirements - AWS ER316L	0.03 max	18.0 - 20.0	11.0 - 14.0	2.0 - 3.0	1.0 - 2.5	0.30 - 0.65
Typical Results ⁽⁵⁾						
As-Welded	0.02	19.0	11.9	2.2	1.8	0.50
All Weld Metal Composition ⁽⁵⁾	0.02	17.8 - 18.4	11.9	2.2	1.6 - 2.0	0.50 - 0.80

TYPICAL OPERATING PROCEDURES

Diameter - in (mm)	Wire Feed Speed - m/min (in/min)	Voltage (volts)	Current (amps)
5/64 [2.0]	2.0-6.1 [80-240]	24-30	190-500
3/32 [2.4]	1.5-5.3 [60-210]	26-32	195-575
1/8 [3.2]	0.9-2.8 [35-110]	28-34	200-700
5/32 [4.0]	0.8-1.9 [30-75]	30-36	320-775

⁽¹⁾Typical all weld metal. ⁽²⁾Measured with 0.2% offset. ⁽³⁾See test results disclaimer ⁽⁴⁾AWS Requirement for ER316 is 0.08% max. carbon.

⁽⁵⁾Results shown correspond with the recommended Lincolnweld® and Blue Max® fluxes listed above, but not required per AWS A5.9-93.

IMPORTANT: SPECIAL VENTILATION AND/OR EXHAUST REQUIRED

Fumes from the normal use of some welding products can contain significant quantities of components - such as chromium and manganese - which can lower the 5.0 mg/m³ maximum exposure guideline for general welding fume.
BEFORE USE, READ AND UNDERSTAND THE SAFETY DATA SHEET (SDS) FOR THIS PRODUCT AND SPECIFIC INFORMATION PRINTED ON THE PRODUCT CONTAINER.

ULTRACORE® 71A85

Mild Steel · AWS E71T-1M-H8, E71T-9M-H8

KEY FEATURES

- Q2 Lot® - Certificate showing actual deposit chemistry and mechanical properties available online
- Available as Batch Managed Inventory
- Fast freezing slag for out-of-position welding
- Designed for welding with 75-85% Argon/balance CO₂ shielding gas
- Premium arc performance and bead appearance
- Meets AWS D1.8 seismic lot waiver requirements
- Each spool is identified with AWS classification and LOT number

WELDING POSITIONS

All

CONFORMANCES

AWS A5.20:	E71T-1M-H8, E71T-9M-H8
ASME SFA-A5.20:	E71T-1M-H8, E71T-9M-H8
ABS:	3YSA H10
Lloyd's Register:	3YS H10
DNV Grade:	III YMS H10
CWB/CSA W48-06:	E491T1-M20 A3-CS1-H8 [E491T-9M-h8] E491T1-M21 A3-CS1-H8 [E491T-9M-H8]
EN ISO 17632-B:	T49 3 T1-1 M21 A H10
FEMA 353	
AWS D1.8	

TYPICAL APPLICATIONS

- Shipbuilding
- Seismic structural fabrication
- General fabrication
- Nuclear power plant construction and maintenance

ASME IX QUALIFICATION

ASME IX Qualification:	QW432 F-No 6, QW442 A-No 1
------------------------	-------------------------------

DIAMETERS / PACKAGING

Diameter in (mm)	33 lb (15 kg) Plastic Spool
0.045 (1.1)	ED033950
1/16 (1.6)	ED033951

MECHANICAL PROPERTIES⁽¹⁾ – As Required per AWS A5.20

	Yield Strength ⁽²⁾ MPa (ksi)	Tensile Strength MPa (ksi)	Elongation %	Charpy V-Notch J (ft-lbf)	
				@ -18°C (0°F)	@ -29°C (-20°F)
Requirements⁽⁴⁾ AWS E71T-1M-H8, AWS E71T-9M-H8	400 (58) min	480-655 (70-95)	22 min	27 (20) min Not Specified	Not Specified 27 (20) min
Typical Results⁽³⁾ As-Welded with 75%-85% Ar/balance CO ₂	550-600 (80-88)	600-650 (87-94)	24 - 26	64-115 (47-85)	43-95 (32-70)

DEPOSIT COMPOSITION⁽¹⁾ – As Required per AWS A5.20

	%C	%Mn	%Si	%S	%P	Diffusible Hydrogen (mL/100g weld deposit)
Requirements⁽⁴⁾ AWS E71T-1M-H8, E71T-9M-H8	0.12 max	1.75 max	0.90 max	0.03 max	0.03 max	8.0 max
Typical Results⁽³⁾ As-Welded with 75%-85% Ar/balance CO ₂	0.03-0.04	1.43-1.56	0.52-0.59	<0.01	0.01	6-8

TYPICAL OPERATING PROCEDURES

Diameter, Polarity Shielding Gas	CTWD ⁽⁵⁾ mm (in)	Wire Feed Speed m/min (in/min)	Voltage (volts)	Approx. Current (amps)	Melt-Off Rate kg/hr (lb/hr)	Deposition Rate kg/hr (lb/hr)	Efficiency (%)
0.045 in (1.1 mm), DC+ 75%-85% Ar/ balance CO ₂	25 (1)	4.4 (175)	21-26	125	1.8 (4.0)	1.6 (3.5)	86-88
		6.4 (250)	22-27	150	2.6 (5.7)	2.3 (5.0)	
		7.6 (300)	23-28	165	3.1 (6.8)	2.7 (6.0)	
		8.9 (350)	23-29	190	3.6 (8.0)	3.2 (7.0)	
		10.2 (400)	25-30	205	4.1 (9.1)	3.6 (8.0)	
		11.4 (450)	26-31	225	4.7 (10.3)	4.1 (9.0)	
		12.7 (500)	27-32	245	5.2 (11.4)	4.5 (10.0)	
		14.0 (550)	28-33	265	5.7 (12.5)	5.0 (10.9)	
1/16 in (1.6 mm), DC+ 75%-85% Ar/ balance CO ₂	25 (1)	3.2 (125)	20-25	185	2.4 (5.3)	2.1 (4.6)	86-88
		4.4 (175)	21-26	215	3.3 (7.4)	2.9 (6.4)	
		5.1 (200)	22-27	235	3.8 (8.4)	3.3 (7.3)	
		5.7 (225)	23-28	265	4.3 (9.5)	3.7 (8.2)	
		6.4 (250)	24-29	285	4.8 (10.5)	4.2 (9.2)	
		7.6 (300)	25-30	315	5.7 (12.6)	5.0 (11.0)	
		8.3 (325)	26-31	335	6.2 (13.7)	5.4 (11.9)	
		8.9 (350)	27-32	365	6.7 (14.7)	5.8 (12.8)	
10.2 (400)	28-33	385	7.6 (16.8)	6.6 (14.6)			

⁽¹⁾Typical all weld metal. ⁽²⁾Measured with 0.2% offset. ⁽³⁾See test results disclaimer ⁽⁴⁾As-Welded with 75%-85% Argon/Balance CO₂ ⁽⁵⁾To estimate ESO, subtract 1/4 in (6.0 mm) from CTWD.
NOTE 1: FEMA and AWS D1.8 structural steel seismic supplement test data can be found on this product at www.lincolnelectric.com. NOTE 2: This product contains micro-alloying elements.
Additional information available upon request.

ULTRACORE® SR-12H

Mild Steel · AWS E71T-1M-JH4, E71T-9M-JH4, E71T-12M-JH4

KEY FEATURES

- Capable of producing weld deposits with impact toughness of 70 - 110 ft-lbs @ -40°F (as welded and after 8 hrs. PWHT @ 1150°F).
- Meets H4 diffusible hydrogen levels
- Q2 Lot® - Certificate showing actual deposit chemistry and mechanical properties per lot available online
- Prior to using this material for ASME Boiler and Pressure Vessel Code Section III applications, please contact the Lincoln Electric Specials Department to receive a Certified Material Test Report (CMTR) which meet all requirements of NCA-3860

WELDING POSITIONS

All

SHIELDING GAS

75-80% Argon / Balance CO₂

CONFORMANCES

AWS A5.20:	E71T-1M-JH4, E71T-9M-JH4, E71T-12M-JH4
ASME SFA-5.20:	E71T-1M-JH4, E71T-9M-JH4, E71T-12M-JH4
ASME SFA-5.29:	E81T1-GM-H4

TYPICAL APPLICATIONS

- Nuclear applications
- Applications requiring PWHT of mild steel

ASME IX QUALIFICATION

ASME IX Qualification:	QW432 F-No 6, QW442 A-No 1
------------------------	-------------------------------

DIAMETERS / PACKAGING

Diameter in (mm)	15 lb (7 kg) Plastic Spool 60 lb (28 kg) Carton
0.045 (1.2)	ED034122

MECHANICAL PROPERTIES⁽¹⁾ – As Required per AWS A5.20

	Yield Strength ⁽²⁾ MPa (ksi)	Tensile Strength MPa (ksi)	Elongation %	Charpy V-Notch J (ft-lbf) @ -40°C (-40°F)
Requirements - AWS E71T-12M-JH4 As-Welded with 75% Ar / 25% CO ₂	400 (58) min	480-620 (70-90)	22 min	27 (20) min
Typical Results⁽³⁾ As-Welded with 75% Ar / 25% CO ₂ Stress-Relieved for 8 hrs. @ 620°C (1150°F)	510-550 (74-80) 450 (65)	570-600 (83-87) 540 (78)	25-32 30	110-200 (80-150) 100-150 (70-110)

DEPOSIT COMPOSITION⁽¹⁾ – As Required per AWS A5.20

	%C	%Mn	%Si	%Ni
Requirements - AWS E71T-12M-JH4 As-Welded with 75% Ar / 25% CO ₂	0.12 max	1.60 max	0.90 max	0.50 max
Typical Results⁽³⁾ As-Welded with 75% Ar / 25% CO ₂	0.03-0.06	1.27-1.60	0.27-0.45	0.34-0.41
	%S	%P	Diffusible Hydrogen (mL/100g weld deposit)	
Requirements - AWS E71T-12M-JH4 As-Welded with 75% Ar / 25% CO ₂	0.03 max	0.03 max	4 max	
Typical Results⁽³⁾ As-Welded with 75% Ar / 25% CO ₂	<0.01	<0.01	1-4	

TYPICAL OPERATING PROCEDURES

Diameter, Polarity Shielding Gas	CTWD ⁽⁴⁾ mm (in)	Wire Feed Speed m/min (in/min)	Voltage (Volts)	Approx. Current (Amps)	Melt-Off Rate kg/hr (lb/hr)	Deposition Rate kg/hr (lb/hr)	Efficiency (%)
0.045 in. (1.1 mm), DC+ 75-80% Ar / balance CO ₂	22 (7/8)	4.4 (175)	22-24	125	1.8 (4.0)	1.5 (3.4)	88
		5.7 (225)	22-24	145	2.3 (5.1)	2.0 (4.4)	
		7.0 (275)	23-25	165	2.9 (6.3)	2.5 (5.5)	
		8.3 (325)	23-25	185	3.4 (7.4)	2.9 (6.4)	
		9.5 (375)	24-26	205	3.9 (8.6)	3.4 (7.5)	
		10.8 (425)	25-27	225	4.4 (9.7)	3.8 (8.4)	
		12.1 (475)	26-28	245	4.9 (10.9)	4.3 (9.5)	

⁽¹⁾ Typical all weld metal. ⁽²⁾ Measured with 0.2% offset. ⁽³⁾ See test results disclaimer. ⁽⁴⁾ To estimate ESO, subtract 1/4 in. (6.0 mm) from CTWD.
Note: This product contains micro-alloying elements. Additional information available upon request.

CONSUMABLES

PACKAGING



TUBES, CANS & CARTONS

5 lb Plastic Tube

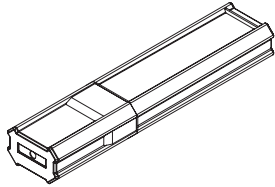

Easy Open (EO) Hermetic Cans

25 & 50 lb EO Can

8 & 10 lb EO Can

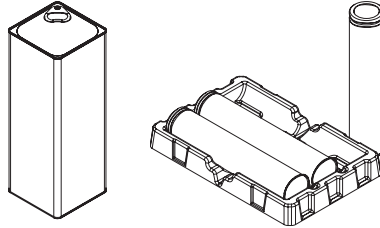

5, 10, 50 lb Cardboard Carton

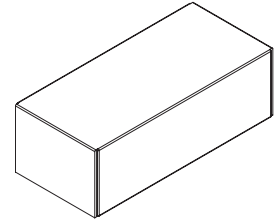

TUBES, CANS & CARTONS

Package Type	Weight (lbs)	Width (in) / Diameter (in)	Height (in)
Tubes			
Tubes	1	1.16	8.3
	5	2.18	14.45
Hermetic Cans			
Easy Open (EO) Cans	8	3	12.62
	10	3	14.62
	25	5	12.62
	50	5	14.62
Carton			
Cardboard Carton	5	1.25	14.25
	10	2.25	14.25
	50	4.75	14.56

Notes: Electrodes come in 12, 14 & 18 inches (300, 350 & 450 mm) lengths.

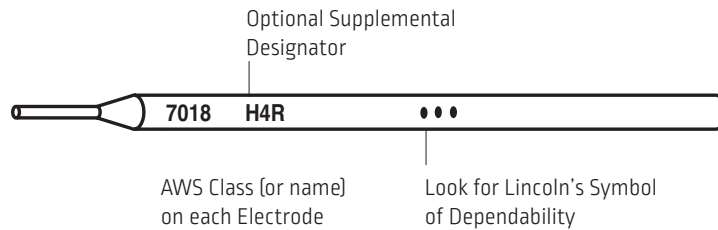

TUBES, CANS & CARTONS

STICK



Easy Open Cans
10 lb & 50 lb



Plastic Tubes
5 lb



Cardboard Carton
5, 10, 50 lb



Plastic Tube
1 lb

REELS & STEM

REELS

Wire Type	Weight (lbs)	Wire Diameter Specifications	"D" Outer Diameter (in)	"W" Outer Width (in)	"D1" Arbor Hole Diameter (in)	"D2" Pin Hole Diameter (in)	"A" Pin Hole Distance from Axis (in)
Speed-Feed® Reels							
Solid	300	-	30	12.75	1.31	0.68	2.5
	750	≤ 1/16 in	30	12.75	1.34	0.75	2.5
	750	≥ 5/64 in	30	12.75	1.31	0.68	2.5
	1000	≤ 1/16 in	30	12.75	1.34	0.75	2.5
	1000	≥ 5/64 in	30	12.75	1.31	0.68	2.5
Flux-Cored	300	-	23.75	11.25	1.31	0.68	2.5
	600	≤ 1/16 in	30	12.75	1.34	0.75	2.5
	600	≥ 5/64 in	30	12.75	1.31	0.68	2.5
	900	-	30	12.75	1.31	0.68	2.5
Precise-Trak® Reel							
Solid	1000	-	30	19.5	1.31	0.68	2.5
Speed-Feed® SlimReel							
Solid	250	-	29.75	6.18	1.31	1.31	8.75

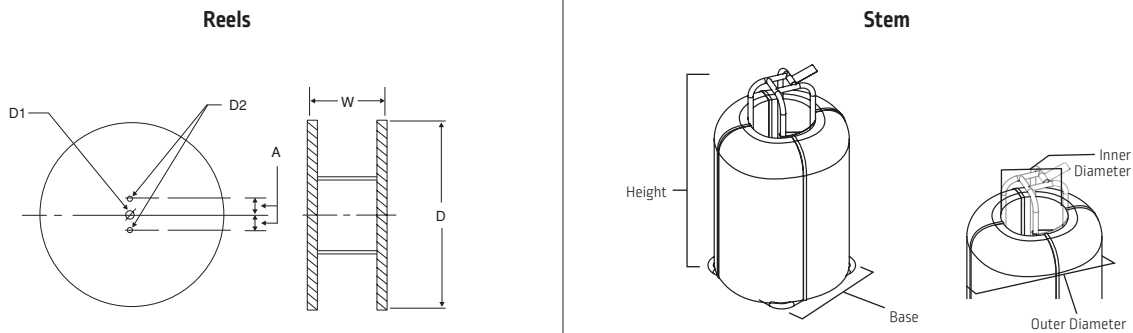

STEM

Wire Type	Weight (lbs)	Base	Stem Height (in)	Wire Stack (in)	
				Inner Diameter	Outer Diameter
Speed-Feed® Stem					
Solid	2200-3000	27.4 x 27.4	54	16	32 - 34

REELS & STEMS

REELS



Precise-Trak® Reel
with Rotary Dispenser (K895-2)

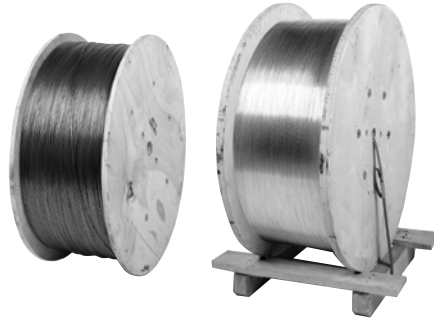

Vertical Speed-Feed® Reel
left: Flux-Cored, right: Solid



Speed-Feed® Reel
left: Flux-Cored, right: Solid



Speed-Feed® SlimReel™
Solid

STEMS



Speed-Feed® Stem

⁽¹⁾ Needs to be rotated to payoff wire

SPOOLS

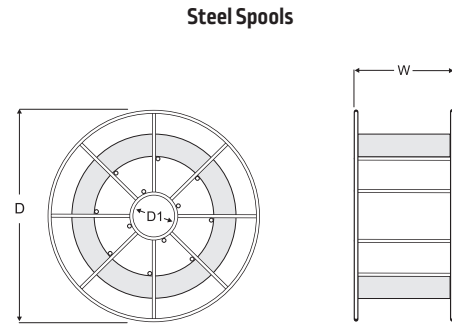
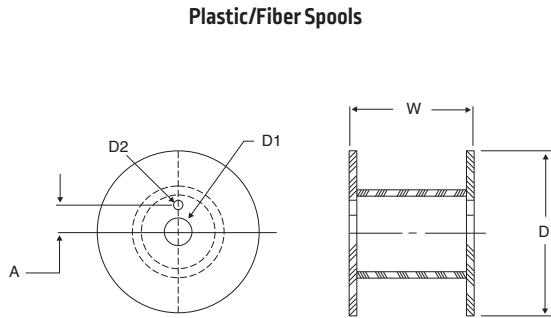

SPOOLS

Wire Type	Weight (lbs)	"D" Outer Diameter (in)	"D1" Inner Diameter (in)	"W" Wound Reel Outer Width (in)	"D1" Arbor Hole Diameter (in)	Pin Hole "D2" Diameter (in)	Pin Hole "A" Distance from Axis (in)
Steel Spools							
Solid or Flux-Cored	25	11.81	2.05	4.25	-	-	-
	33	11.81	2.05	4.25	-	-	-
	44	11.81	2.05	4.25	-	-	-
Plastic Spools							
Solid (Mild Steel)	2	4.00	-	1.75	0.63	-	-
	10	8.00	-	2.16	2.03	0.44	1.75
	11	8.00	-	2.16	2.03	0.44	1.75
	12.5	8.00	-	2.16	2.03	0.44	1.75
	33	12.00	-	4.19	2.03	0.44	1.75
Solid (Copper Alloys)	33	12.00	-	4.19	2.03	0.44	1.75
Solid (Aluminum)	1	4.00	-	1.75	0.28	-	-
	16	11.88	-	4.00	2.00	0.47	1.75
	20	11.88	-	4.00	2.00	0.47	1.75
Flux-Cored/ Metal-Cored	10	8.00	-	2.16	2.03	0.44	1.75
	15	8.00	-	3.00	2.03	0.44	1.75
	25	12.00	-	4.00	2.03	0.44	1.75
	33	12.00	-	4.00	2.03	0.44	1.75
Fiber Spools							
Solid	44	12.00	-	4.30	2.03	0.44	1.75
	60	14.00	-	4.30	2.03	0.44	1.75
Flux-Cored	33	12.00	-	4.30	2.03	0.44	1.75
	50	14.00	-	4.30	2.03	0.44	1.75

SPOOLS

SPOOLS



Steel Spool
Solid & Flux-Cored - 33 lb

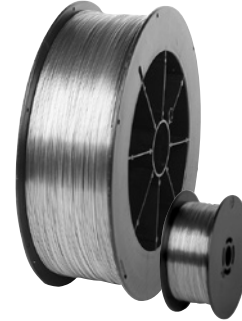

Plastic Spool
Flux-Cored - 25 lb, 1 lb



Plastic Spool
Solid, Mild Steel - 33 lb, 12.5 lb, 2 lb,
Solid, Copper Alloys - 33 lb



Plastic Spool
Solid, Aluminum - 16 lb, 1 lb



Fiber Spool
Solid, Mild Steel - 60 lb, Flux-Cored - 33 lb, 44 lb, 50 lb

COILS, BOXES & BAGS

COILS

Wire Type	Weight (lbs)	Wire Diameter Specifications	"D" Outer Diameter (in)	"D1" Inner Diameter (in)	"W" Wound Reel Outer Width (in)
Solid	55 & 60	≤ 1/16 in	16.50	12.00	4.40
	55 & 60	≥ 5/64 in	16.50	12.00	4.60
Flux-Cored	14	-	9.50	6.70	3.00
	50 & 60	-	16.50	12.00	4.60

Coils

COIL ADAPTERS

System	Part #	Description
Automatic wire feeders - LT-7 Tractor systems	K299	Wire reel adapter for 50 lb & 60 lb coils
SAW coil nd supported coil adapter for 2 inch (51mm) spindle	K1504-1	Spindle adapter for 50 lb & 60 lb coils
FCAW coil adapter for 2 inch (51mm) spindle	K435	Spindle adapter For 14 lb coils

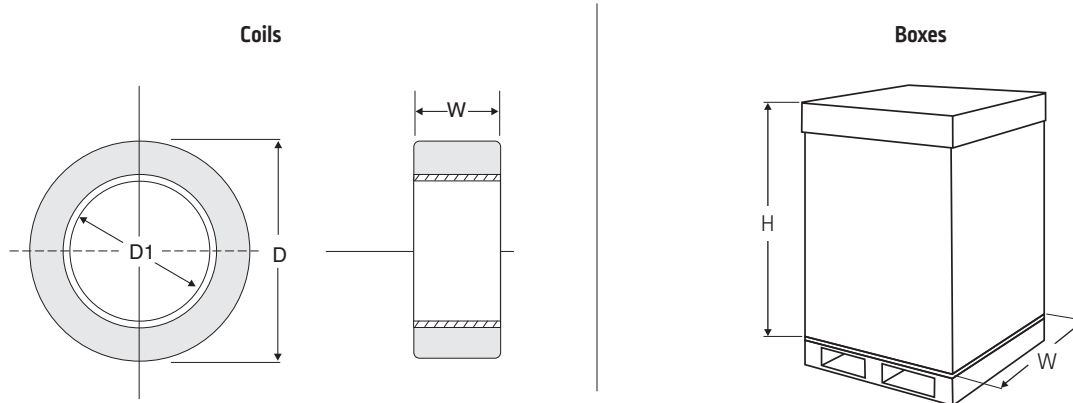

BOXES

Wire Type	Weight (lbs)	Outside Dimensions L x W x H (in)	Core Dimensions (in)
Gem-Pak® Box			
Solid (Aluminum)	300	24 x 24 x 32	14
Solid (Copper Alloys)	500	24 x 24 x 32	14
Accu-Pak® Box			
Solid (Mild Steel)	500	21 x 21 x 28	-
	900-1000	24 x 24 x 32	-

BAGS

Wire Type	Weight (lbs)	Dimensions (in)
Paper Bag / Plastic Bag / Sahara ReadyBag™		
Flux	50	-
Bulk Bag		
Flux	2600 - 3000	43 x 43 x 48 ⁽¹⁾

⁽¹⁾Values are maximums.

COILS, BOXES & BAGS

COILS



Flux-Cored
14 lb Coil (56 lb HS Pail)



Flux-Cored
50 lb



Solid Wire
60 lb

COIL ADAPTERS



Wire Reel Assembly
Accommodates 50 lb & 60 lb



Coil and Supported Coil Adapter 60 lb
Accommodates 50 lb & 60 lb



Spindle Adapter For 14 lb Coils
Accommodates 14 lb

BOXES



Accu-Pak® Boxes
1500, 1000 & 500 lb

BAGS



Paper Bag



Plastic Bag



Sahara ReadyBag™



Bulk Bag

DRUMS & PAILS

Drums

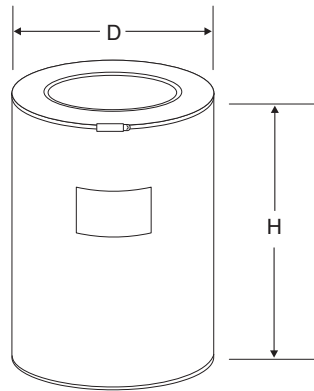

DRUMS

Wire Type	Weight (lbs)	Outer Diameter (in)	Outer Height (in)	Core Inside Diameter	Core Height
Speed-Feed® Drum					
Solid	300	23.4	17.8	16	17
	600	23.4	34.8	16	34
	1000	23.4	34.8	16	34
Flux-Cored	125	23.4	11.1	16	10
	300	23.4	17.8	16	17
	500 and 600	23.4	34.8	16	17
Accu-Trak® Drum					
Solid	250	23.4	19.7	-	-
	500	20.4	32.6	-	-
	1000	23.4	34.8	-	-
Flux-Cored	300, 400 and 500	20.4	32.6	8.4	31.5
	500 and 600	23.4	34.8	8.4	34
Metal-Cored	500	20.4	32.6	8.4	31.5
Mini-Drum					
Solid (Aluminum)	60	20.4	13	-	-
Steel Drum					
Flux	550	22.75	33.50	-	-

PAILS

Wire Type	Weight (lbs)	Outer Diameter (in)	Outer Height (in)	Core Inside Diameter	Core Height
Hermetically Sealed Pail					
Flux	50	12	14.75	-	-

DRUMS & PAILS

DRUMS

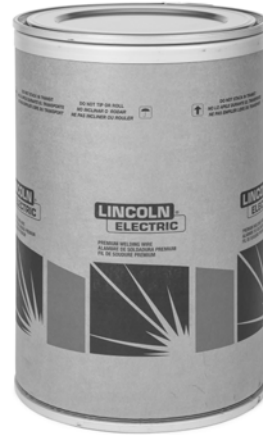
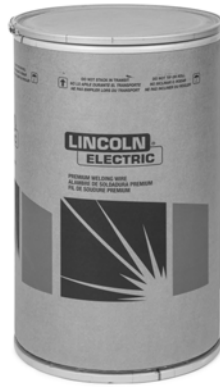

Mini Drum/Accu-Trak[®]/Speed-Feed^{®(1)} Drums



Steel Drum⁽²⁾

PAIL



Hermetically Sealed Pail



Hermetically Sealed Pail as Master Package

⁽¹⁾ Needs to be rotated to payoff wire. ⁽²⁾ This product does not come on a pallet. If your application requires a pallet, please contact your local Lincoln Electric sales representative.

STICK ELECTRODES

Storage & Handling

STORING LOW HYDROGEN ELECTRODES

Low hydrogen electrodes must be dry to perform properly. Unopened hermetically sealed containers provide excellent protection in good rod cabinet conditions. Opened cans of electrodes should be stored in a cabinet at 120°-150°C (250°-300°F).

Moisture resistant electrodes with an "R" suffix have a high resistance to coating moisture pick-up.

However, all low hydrogen electrodes should be stored properly, even those with an "R" suffix. Standard EXX18 electrodes should be supplied to welders twice per shift. Moisture resistant types may be exposed for up to 9 hours. Specific code requirements may indicate exposure limits different from these guidelines.

Depending on the amount of moisture absorbed and other factors, moisture pickup can degrade weld quality in various ways:

1. Moisture in low hydrogen electrodes may cause porosity. This porosity could be completely subsurface and require x-ray inspection or destructive testing. The porosity could also be visible, external porosity.
2. High moisture can also lead to excessive slag fluidity, a rough weld surface, and difficult slag removal.
3. Excessive moisture in low hydrogen electrodes will lead to elevated levels of diffusible hydrogen which, in turn, can lead to hydrogen-induced weld cracking and/or underbead cracking.

RE-DRYING LOW HYDROGEN ELECTRODES

Re-drying, when done correctly, restores the electrodes' ability to deposit quality welds. Proper re-drying temperature depends upon the electrode type and its condition. One hour at the listed final temperature is satisfactory. DO NOT dry electrodes at higher temperatures. Several hours at lower temperatures is not equivalent to using the specified requirements.

Electrodes of the E8018 and higher strength classifications should be given no more than three 1-hour re-dries in the 370°-430°C (700°-800°F) range. This minimizes the possibility of oxidation of alloys in the coating which would result in lower than normal tensile or impact properties.

Any low hydrogen electrode should be discarded if excessive re-drying causes the coating to become fragile and flake or break off while welding, or if there is a noticeable difference in handling or arc characteristics, such as insufficient arc force.

Electrodes to be re-dried should be removed from the can and spread out in the oven because each electrode must reach the drying temperature.

STORING CELLULOSIC ELECTRODES

Electrodes in unopened Lincoln cans or cartons retain the proper moisture content indefinitely when stored in good condition.

If exposed to humid air for long periods of time, electrodes from opened containers may pick up enough moisture to affect operating characteristics or weld quality. If moisture appears to be a problem, store electrodes from the opened containers in heated cabinets at 40° to 50°C (100° to 120°F).

STORING AND RE-DRYING NON-LOW HYDROGEN ELECTRODES

Electrodes in unopened Lincoln cans or cartons retain the proper moisture content indefinitely when stored in good condition.

If exposed to humid air for long periods of time, electrodes from opened containers may pick up enough moisture to affect operating characteristics or weld quality. If moisture appears to be a problem, store electrodes from the opened containers in heated cabinets at 40° to 50°C (100° to 120°F). DO NOT use higher temperatures.

Some electrodes from wet containers or long exposure to high humidity can be re-dried. Follow the procedures below for each type.

Using longer drying times or higher temperatures can easily damage the electrodes.

For drying, remove the electrodes from the container and spread them out in the rod cabinet because each electrode must reach the drying temperature.

STICK ELECTRODES

Storage & Handling

RE-DRYING CONDITIONS - LOW HYDROGEN

Condition	Pre-drying Temperature ⁽¹⁾	Final Re-drying Temperature
Electrodes exposed to air for less than one week; no direct contact with water.	—	370° - 430°C (700° - 800°F)
Electrodes which have come in direct contact with water or which have been exposed to high humidity.	80 - 105°C (180° - 220°F)	370° - 430°C (700° - 800°F)

RE-DRYING CONDITIONS - NON-LOW HYDROGEN

Electrode	Electrode Group	Final Re-drying Temperature	Time
E6010: E6011: E7010-A1 ⁽¹⁾ : E7010-G ⁽¹⁾ : E8010-G ⁽¹⁾ : E9010-G ⁽¹⁾ :	Excessive moisture is indicated by a noisy arc and high spatter, rusty cored wire at the hold end or objectionable coating blisters while welding. Rebaking of this group of electrodes is not recommended.	Not Recommended	—
E7024: E6027:	Excessive moisture is indicated by a noisy or "digging" arc, high spatter, tight slag, or undercut. Pre-dry unusually damp electrodes for 30 - 45 minutes at 90°C to 110°C (200°F to 230°F) before final drying to minimize cracking of the coating.	200° - 260°C (400° - 500°F)	30 - 45 minutes
E6013: E7014: E6022:	Excessive moisture is indicated by a noisy or "digging" arc, high spatter, tight slag, or undercut. Pre-dry unusually damp electrodes for 30 - 45 minutes at 90°C to 110°C (200°F to 230°F) before final drying to minimize cracking of the coating.	150° - 180°C (300° - 350°F)	20 - 30 minutes

⁽¹⁾Pre-dry for 1-2 hours.

STAINLESS STEEL & NICKEL

Storage & Handling

STORING STAINLESS STEEL AND NICKEL

Excalibur® stainless steel covered electrodes should be handled and stored as if they were low hydrogen electrodes for welding low alloy steels. They should be protected from moisture pickup. The consequences of moisture pickup with Excalibur stainless electrodes do not include cold cracking, as would be the case with low alloy steels, unless they are used for dissimilar metal joining. But if Excalibur stainless electrodes are exposed for extended periods a humid environment, the coating can pick up enough moisture to cause

starting porosity and/or center line porosity. The electrode should be stored in sealed cans, or stored in an oven at about 120°C (250°F); this is also recommended for flux-cored wires. Plastic spools can be baked up to 66°C (150°F) with no issues. Stainless can be restored to like new conditions by baking one hour at 345-425°C (650-800°F). Nickel electrodes should be reconditioned before by baking in drying oven for 1-2 hours at 204-260°C (400-500°F).

METAL-CORED & FLUX-CORED WIRE

Storage & Handling

SHELF LIFE

As a general rule, The Lincoln Electric Company estimates maximum storage time for mild and low alloy steel consumables to be 3 years. This estimate is for material in the original, undamaged packages that is stored indoors at up to ~70% relative humidity and that are protected from the weather or other adverse conditions. Packages should be stored under conditions that minimize the likelihood of temperature variations that cause moisture condensation on the consumables.

These estimates are based on what we know about the packaging materials and the frequency of product improvements. Since actual storage conditions vary widely across geographical regions and from one customer to another, it is not possible to be more specific. For packages that are not hermetically sealed, a shorter storage time is advisable under sustained severe humidity conditions but is not possible to estimate. Note that product stored for longer than 3 years, may still be suitable for use. It depends on the product and the condition it is in.

Dispose of any wire or rod that has visible signs of rust.

Customers are not encouraged to store consumables for extended periods of time. It is advisable to maintain turnover in inventory to ensure the products are as close to their as manufactured conditions as can be reasonably expected. The general guidelines above are provided for those unplanned instances where product is stored longer than originally anticipated.

STORAGE OF UNOPENED PACKAGES

FCAW products should be stored in the original, unopened packaging until ready to use. To maintain the integrity of these products, electrodes must be protected from the atmosphere. All flux cored electrodes, regardless of package, should be protected from condensation, including rain or snow. To ensure that condensation does not form on the product, it is recommended that the electrode be stored in an environment that is kept above the dew point temperature for a given relative humidity. Minimizing temperature variation will also help to protect the electrode from moisture condensation. It is advisable to maintain turnover in inventory to ensure the product is as close to the manufactured condition as possible.

For applications in which the weld metal hydrogen must be controlled (usually 8 mL/100g or lower), or where shipping and storage conditions are not controlled or known; only hermetically sealed packaging is recommended.

HANDLING OF WIRES OUT OF THE PACKAGE

The following minimum precautions should be taken to safeguard the wire after opening the original package:

- It is recommended to use wires within one week of opening the original package.
- Open wires should not be exposed to damp moisture conditions or extremes in temperature and/or humidity where surface condensation can occur.
- When not in use, wires should be placed in original packaging and sealed as best as possible.
- If exposed to moisture conditions, discard any rusty wire.
- After exposure, hydrogen levels can be reduced by conditioning the wire. Wires may be conditioned at a temperature of 212°F ± 25°F (100°C ± 4°C) for a period of 6 to 12 hours, cooled and then stored in a sealed poly bags (4 mil minimum thickness) or equivalent. Wire on plastic spools should not be heated at temperatures in excess of 150°F (65°C).

WHEN TO DISPOSE OF PRODUCT

It is advisable to dispose of any wire that has visible signs of rust on the wire where the package integrity has been compromised. When proper storage procedures are not followed, consumables may show signs of high moisture. High moisture can result in rough bead surface or slag that is unusually difficult to remove. In addition, it can also result in visible and/or internal porosity in the weld deposit, increase spatter, and decreased puddle control which can increase chances of slag entrapment. Oxidation (rust) of either the surface of the wire or internal fluxing agents increases the oxygen content of the wire that can lead to changes in alloy recovery. This, in turn, can deteriorate the mechanical properties of the weld metal.

SOLID WIRES & SUBMERGED ARC FLUX

Storage & Handling

STORAGE FOR SUBMERGED ARC FLUX

Flux Package Type ⁽¹⁾	Flux Storage Conditions for General Welding Applications	Flux Storage for Applications Requiring Diffusible Hydrogen Control
Plastic or Multi-Wall Plastic/Paper Bag	Store indoors at < 90% RH Protect from condensation	Store indoors at < 70% RH and 5°C - 50°C (40°F - 122°F). Protect from condensation
Bulk Bag with Liner	Store indoors at < 90% RH Protect from condensation	Store indoors at < 70% RH and 5°C - 50°C (40°F - 122°F). Protect from condensation
Steel Drum	Protect from rain or snow	Protect from rain or snow
Plastic Pail	Protect from rain or snow	Protect from rain or snow
Sahara ReadyBag™	Protect from rain or snow	Protect from rain or snow

STORAGE FOR ALL MIG, TIG, AND SAW SOLID WIRES⁽²⁾

Wire Package Type ⁽¹⁾	Wire Storage Conditions for All Welding Applications
Any Type	Protect from rain or snow. Protect from condensation. DO NOT use wire with visible signs of rust.

⁽¹⁾For other package types, consult your Technical Representative. ⁽²⁾All as in Stainless, Nickel, Low Alloy, and Mild Solid Wires.

RE-DRYING & RECYCLING FLUX

Lincoln Electric submerged arc welding flux can be used directly from its original, undamaged package, if it has been stored according to the conditions listed in the chart above.

When proper procedures are not followed, flux may show signs of moisture. These can include porosity, a rough bead surface or slag that is unusually difficult to remove. In many instances these fluxes can be re-dried in general welding applications.

RE-DRYING FLUX

To re-dry fluxes other than MIL800-H, MIL800-HPNi and 842-H fluxes

- Remove flux from its original packaging and place in a clean oven set between 260°-480°C (500°-900°F).
- Leave in oven long enough to raise the temperature of the entire bulk of flux to your set temperature for a minimum of one hour.
- For ovens in which heating rods are inserted into the flux, do not let the temperature of flux adjacent to the rods exceed 480°C (900°F).
- For all other applications requiring diffusible hydrogen control set temperature at approximately 425°C (800°F).

For MIL800-H, MIL800-HPNi and 842-H fluxes

Follow all previous procedures, with the following changes:

- Set temperature between 120°-205°C (250°-400°F).
- For ovens in which heating rods are inserted into the flux, do not let the temperature of flux adjacent to the rods exceed 205°C (400°F).

RECYCLING FLUX

Non-consumed flux may be collected from the finished weld and recycled. To do so, please follow these procedures:

- Remove slag, metal, mill scale, and any other contaminants from the flux.
- Prevent damage to the flux from heavy impingement in flux transport systems.
- Avoid the separation of different sized particles in cyclones or "dead" corners.
- Remove excess fines from recycled fluxes.
- For optimal welding characteristics, it is recommended to add at least 20% new flux by weight to recycled flux.

ACCU-PAK® BOX

Storage & Handling

GENERAL INFORMATION

Never tip or roll an Accu-Pak® box – box shall be kept vertical at all times.

LIFTING STRAP INSTRUCTIONS

(The following instructions are in no way intended to supersede the manufacturers' instructions for the use of their lifting device)

1. Place the wooden master pallet on the floor.
2. Remove all stretch wrap and/or tape binding the boxes together.
3. Prior to lifting, inspect the box for dents, gashes or holes penetrating the side of the box, and dented or crushed box lids. **NEVER LIFT DAMAGED BOXES.**
4. Remove the strap loops from the slots on the box lid.
5. Confirm the two strap loops are from the same box.
6. Do not remove the lid while moving the box.
7. For 500 lb & 1000 lb Accu-Pak boxes, the straps may be placed directly on the tow motor forks. Configure the straps according to the pictures below for proper use. Straps should come up vertically. For 1500 lb Accu-Pak boxes, a lifting device must be used. For all boxes, if a lifting device is used, follow the manufacturer's instructions to assure proper handling.



8. Lift the box straight up off the wooden master pallet. **DO NOT LIFT AT AN ANGLE.**
9. Avoid sudden starts and stops.
10. When using an overhead crane, use standard safety procedures.
11. Once the Accu-Pak box has been placed at its point of use, follow the instructions inside the center of the box for proper set up.

MINI PALLET INSTRUCTIONS

1. Follow the first 3 steps listed for lifting with straps.
2. Extend the tow motor forks to completely reach through the mini pallet to ensure the box does not tip or fall over. Verify that the mini pallet and Accu-Pak box are secure and are 100% in contact with the tow motor.
3. Then proceed to lift and place the box at its intended location.



CAUTION

1. Boxes should never be lifted to a height greater than necessary – when moving boxes, while in the air, the box can start swinging resulting in injury.
2. Appropriate care should be taken to avoid pinch points when moving the box.
3. Appropriate personal safety equipment should be worn to prevent injury such as a safety helmet to prevent head injury.
4. When lifting a box, care should be given to the path the box will take in getting to its intended location as to avoid collision with other items.
5. Do not walk under the box while it is in the air and never move the box over others.
6. Only qualified material handling personnel should attempt lifting or handling the Accu-Pak box.
7. Lincoln Electric is not responsible for consequential damage due to improper lifting or movement of box.

ACCU-TRAK® DRUM & SPEED-FEED® DRUM

Storage & Handling

GENERAL INFORMATION

Never tip or roll an Accu-Trak® or Speed-Feed® drum – drum shall be kept vertical at all times.

Only use appropriate lifting devices designed for lifting fiber drums with steel chimes, within manufacturers' ratings while adhering to manufacturers' instructions.

LIFTING WITH A DRUM LIFTING DEVICE

(The following instructions are in no way intended to supersede the manufacturers' instructions for the use of their lifting device)

1. Place the wooden master pallet on the floor.
2. Remove shrink-wrap, cut and remove the band that secures all four drums together.
3. After removing the shrink-wrap from the perimeter of the pallet of drums, the banding that wraps around the top chime of the drum, tying the drums together, should be removed.
4. The band, which secures the drum to the mini pallet, may also be removed (optional).
5. Prior to lifting, inspect the drum for dents, gashes or holes penetrating the side of the drum, and dented or crushed drum lids or chimes. Verify the drum is closed and the chimes are in the locked position. **NEVER LIFT A DAMAGED OR OPEN DRUM.**
6. After inspection, the grippers of drum lifting device should be placed in the groove of the top chime. Placing the gripper of one side of the lifting device in the center of the drum pallet and catching the mating groove in the top chime makes the effort easier.
7. The device can then be opened and placed in the groove, 180 degrees from the starting point. After verifying that the grippers on both sides of the lifting device are properly secured and are in 100% contact with the groove in the top drum chime, lifting of the drum can proceed.
8. Place the drum at its intended location and remove the lifting device.

250-600 LB ACCU-TRAK DRUMS AND SPEED-FEED DRUMS

The 500 lb. drums come standard four drums per pallet. These drums are placed directly on the surface of the pallet.

1000 LB OR > ACCU-TRAK DRUMS & SPEED-FEED DRUMS

The 1000 lb. drums come standard four drums per pallet. Each drum is placed on an individual mini pallet then mounted on a master pallet. The mini-pallet is used to facilitate the moving of these drums with a standard tow motor.



⚠ CAUTION ⚠

1. Drums should never be lifted to a height greater than necessary – when moving drums, while in the air, the drum can start swinging resulting in injury
2. Appropriate care should be taken to avoid pinch points when moving the drum
3. Appropriate personal safety equipment should be worn to prevent injury such as a safety helmet to prevent head injury
4. When lifting a drum, care should be given to the path the drum will take in getting to its intended location as to avoid collision with other items
5. Do not walk under the drum while it is in the air and never move the drum over others
6. Only qualified material handling personnel should attempt lifting or handling the Accu-Trak and Speed-Feed drums
7. Lincoln Electric is not responsible for consequential damage due to improper lifting or movement of drums

CONSUMABLES

APPENDIX



AWS CLASSIFICATION SYSTEM

Stick (SMAW)

Mild & Low Alloy Steel per AWS A5.1/A5.1M and AWS A5.5/A5.5M

CLASSIFICATION DESIGNATORS PER AWS A5.1 & A5.5

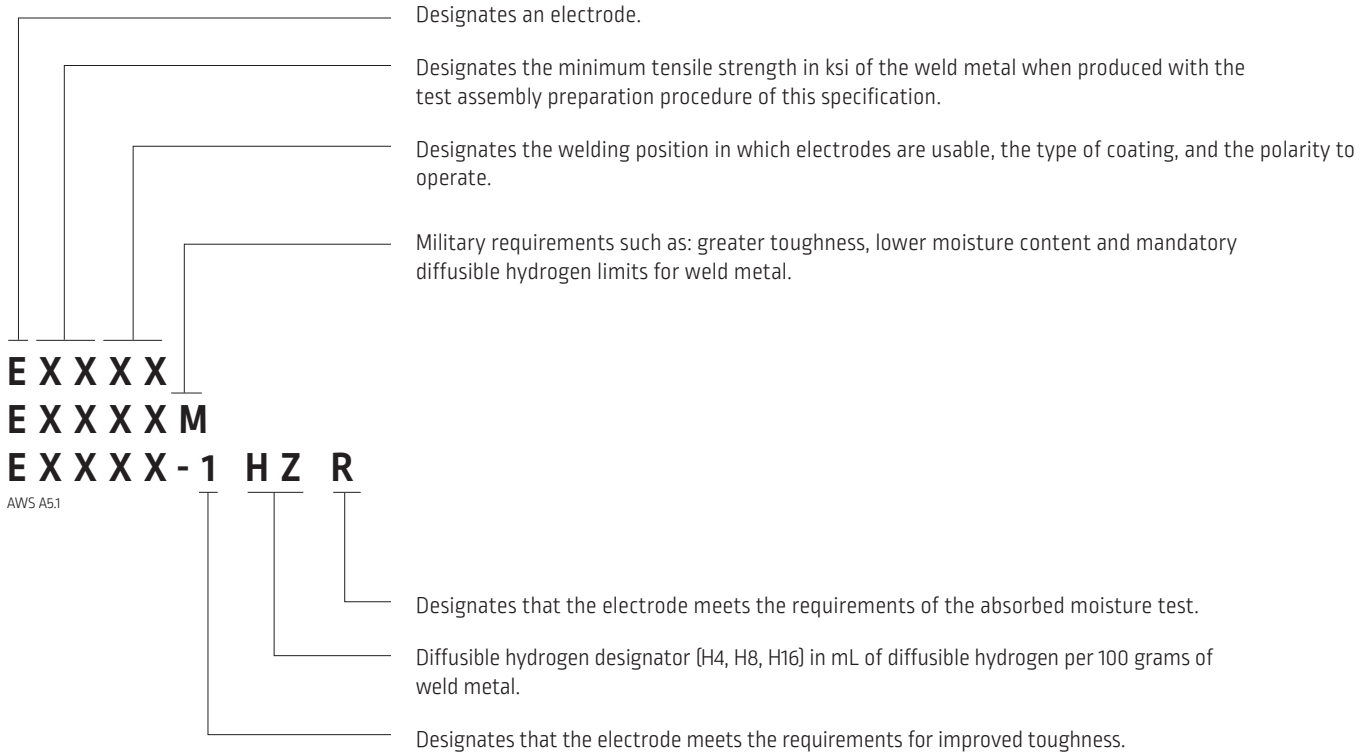

CLASSIFICATION DESIGNATORS PER AWS A5.5 ONLY

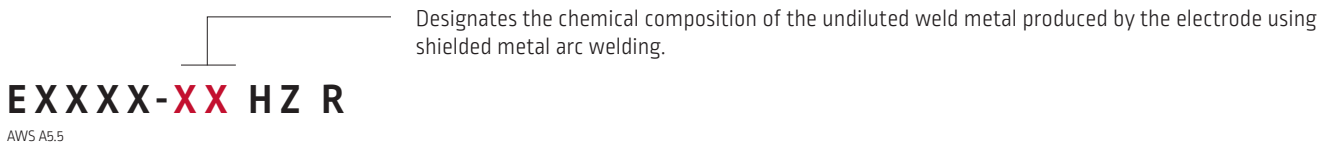

ADDITIONAL CLASSIFICATIONS

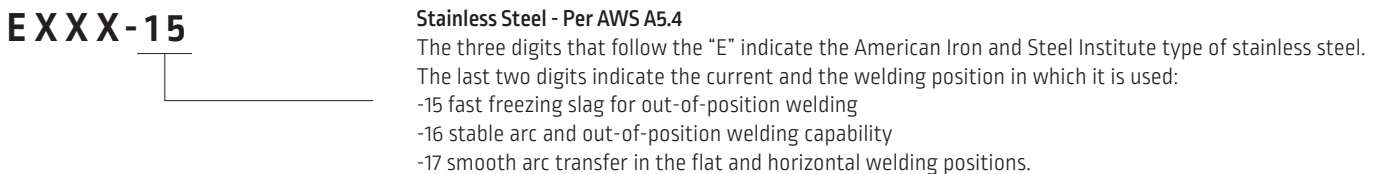

AWS CLASSIFICATION SYSTEM

MIG (GMAW), TIG (GTAW) & Metal-Cored (GMAW-C)

Mild & Low Alloy Steel per AWS A5.18/A5.18M and AWS A5.28/A5.28M

CLASSIFICATION DESIGNATORS PER AWS A5.18 & A5.28

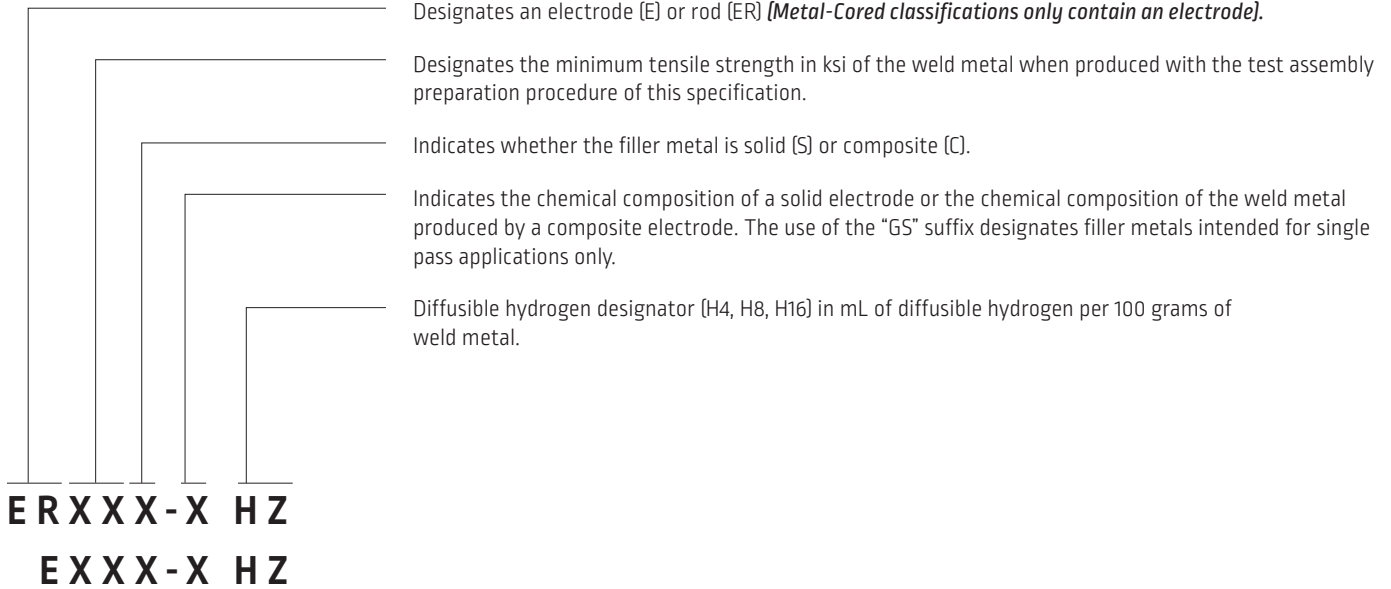

ADDITIONAL CLASSIFICATIONS

- Aluminum – Per AWS A5.10/A5.10M**
ERXXXX The first digit following "E" or "ER" indicates the principle alloying element or elements (4 – Silicon, 5 – Magnesium). If the second digit following "E" or "ER" is different from zero, it denotes a modification to the original alloy. The last two digits are used to identify the specific alloy.
- Stainless – Per AWS A5.9/A5.9M**
ERXXXLSi The three digits following "E" or "ER" specify the chemical composition of the filler metal with a series of numbers. In some cases, chemical symbols for the letter L (low carbon), Si (high silicon), or H (high carbon) will follow to designate modifications of basic alloy types.
- Nickel Alloy – Per AWS A5.14/A5.14M**
ERXXXX-X The chemical symbol "Ni" appears in the designations immediately after "E" or "ER" to identify the filler metal as a nickel-based alloy. Other symbols such as Cr and Mo in the designation are intended to group the filler metals according to their principal alloying elements. The number at the end of the designation separates one composition from another within a group.

AWS CLASSIFICATION SYSTEM

Flux-Cored (FCAW)

Mild & Low Alloy Steel per AWS A5.20/A5.20M and AWS A5.29/A5.29M

CLASSIFICATION DESIGNATORS PER AWS A5.20 & A5.29

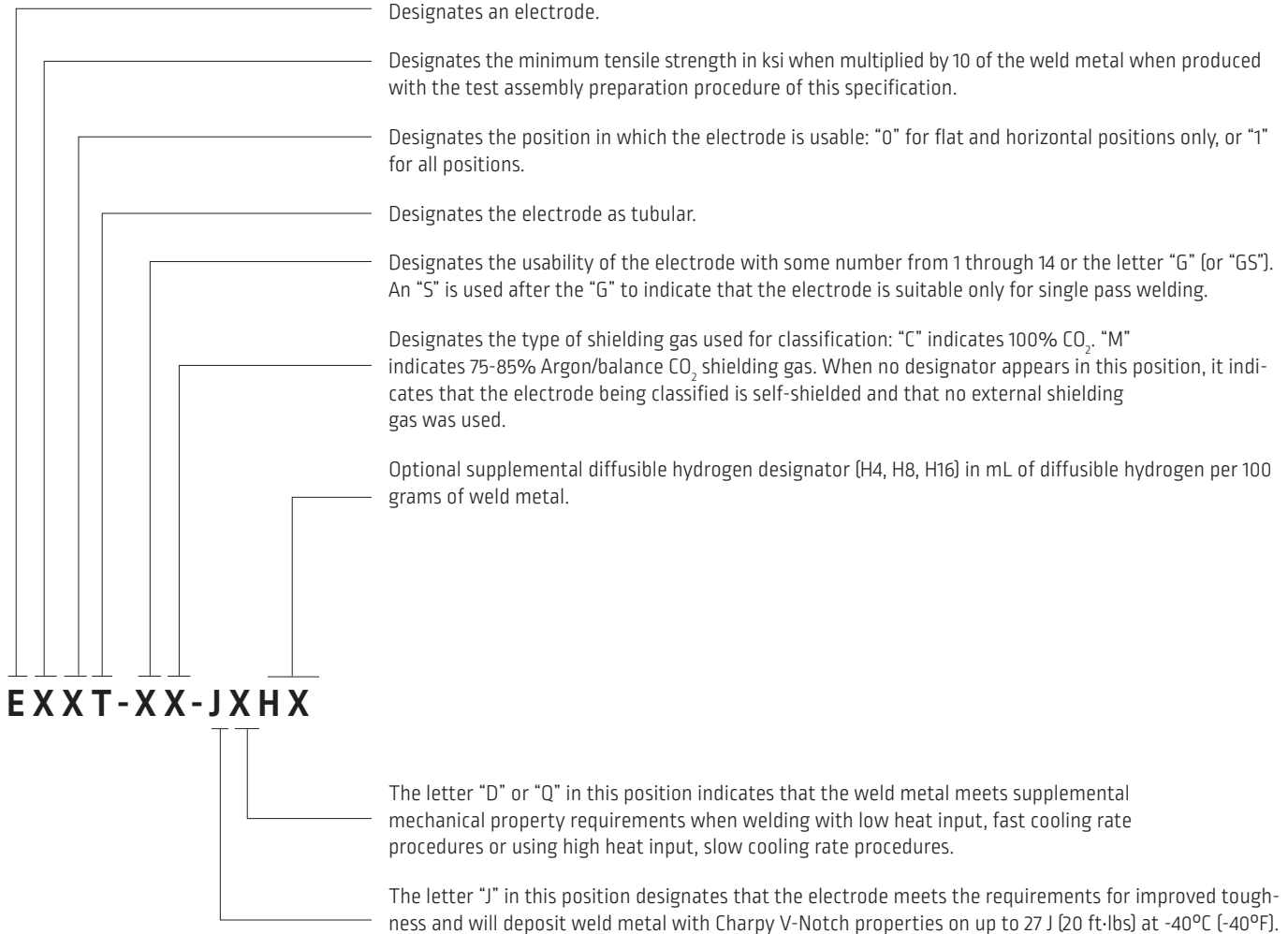

AWS CLASSIFICATION SYSTEM

Flux-Cored (FCAW)

Mild & Low Alloy Steel per AWS A5.20/A5.20M and AWS A5.29/A5.29M

CLASSIFICATION DESIGNATORS PER AWS A5.29 ONLY

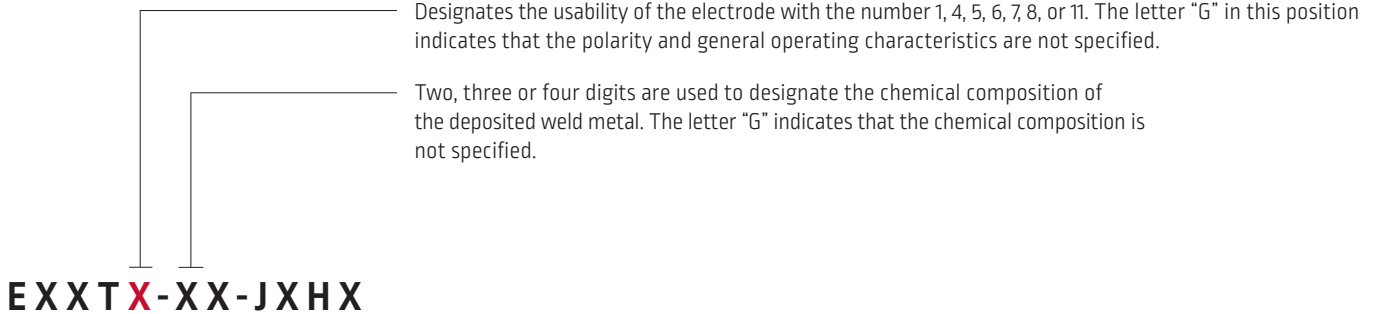

ADDITIONAL CLASSIFICATIONS

Stainless Steel - Per AWS A5.22/A5.22M

EXXTX-X The three digits that follow "E" designate the chemical composition of the weld metal. The digit following "T" designates the position in which the electrode is usable: "0" for flat and horizontal positions only, or "1" for all positions.

AWS CLASSIFICATION SYSTEM

Flux-Cored (FCAW)

Mild & Low Alloy Steel per AWS A5.36/A5.36M

CLASSIFICATION DESIGNATORS PER AWS A5.36

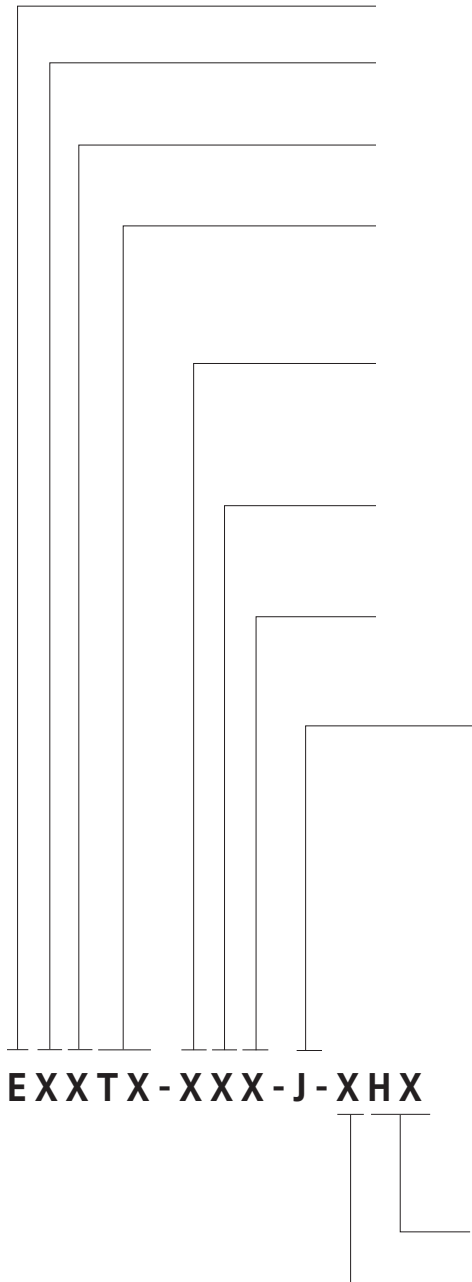

Designates an electrode.

Designates the minimum tensile strength in ksi when multiplied by 10 of the weld metal deposited with the electrode under the welding conditions specified in this specification.

Designates the position in which the electrode is usable: "0" for flat and horizontal positions only, or "1" for all positions.

Designates the usability of the electrode, the letter "T" followed by some number from 1 through 17 or the letter "G." The letter "T" identifies the electrode as a flux-cored electrode or metal-cored electrode. An "S" is used after the "G" to indicate that the electrode is suitable only for single pass welding.

Designates the type of shielding gas, if any, used for classification. The letter "Z" in this position indicates that the shielding gas composition is agreed upon between supplier and purchaser. When no designator appears in this position, it indicates that the electrode is self-shielded and that no external shielding gas is used.

Designates the condition of heat treatment in which the tests were conducted: "A" is for as-welding and "P" is for postweld heat treated. This designator omitted when the electrode being classified is intended for single pass welding only.

Indicates the temperature in °F at or above which the weld metal meets the requirement for Charpy V-Notch impact toughness of 27 J (20 ft·lbf). Two digits are used for test temperatures of -100°F or lower.

Designates the composition of the deposited weld metal using one, two or three characters. The letter "G" indicates that the chemical composition is not specified. No designator used in this position when the electrode being classified is a single pass electrode.

Optional, supplemental diffusible hydrogen designator.

For flux-cored electrodes, the letter "D" or "Q" when present in this position indicates the weld metal will meet supplemental mechanical property requirements.

AWS CLASSIFICATION SYSTEM

Submerged Arc (SAW) Flux & Electrode

Classification Descriptions for AWS A5.17 & A5.23

The electrode classification identifies the chemical composition of the electrode. The following paragraphs highlight the differences between these electrodes and electrode groups and indicate typical applications.

MILD STEEL ELECTRODES

EL8, EL8K, EL12, EM11K, EM12, EM12K, EM13K, EM14K, EM15K, EH10K, EH11K, EH12K and EH14

Carbon steel electrodes which vary from one another in their carbon, manganese, and silicon contents. EM14K electrodes also contain small additions of titanium, although they are considered carbon steel electrodes.

LOW ALLOY ELECTRODES

EA1, EA2, EA3, EA3K, and EA4 (C-Mo Steel)

Similar to the medium manganese and high manganese carbon steel electrodes shown above except that 0.5% molybdenum is added.

EB1, EB2, EB2H, EB3, EB5, EB6, EB6H, EB8, and EB9 (Cr-Mo Steel)

Produce weld metal containing between 0.5% and 10% chromium and between 0.5% and 1% molybdenum.

The letter "R" when added as a suffix to the EB2 or EB3 electrode classification or to the B2 or B3 weld metal designation is an optional supplemental designator indicating that the electrode will meet the reduced residual limits necessary to meet "X" factor requirements for step cooling applications.

Since all Cr-Mo weld deposits will air harden in still air, both preheat and postweld heat treatment (PWHT) are required for most applications.

EB9 is a 9% Cr-1% Mo electrode modified with niobium (columbium) and vanadium designed to provide improved creep strength, and oxidation and corrosion resistance at elevated temperatures.

ENi1, ENi1K, ENi2, and ENi3 (Ni Steel) – Designed to produce weld metal with increased strength without being hardenable or with increased notch toughness at temperatures as low as -100°F (-73°C) or lower. They have been specified with nickel contents which fall into three nominal levels of 1% Ni, 2.5% Ni, and 3.5% Ni.

ENi4, ENi5, EF1, EF2, and EF3 (Ni-Mo Steel)

Contain between 0.5% and 2% nickel and between 0.25% and 0.5% molybdenum.

EF4, EF5, and EF6 (Cr-Ni-Mo Steel) – A combination of Cr, Ni, and Mo develop the strength levels and notch toughness required for a number of high-strength, low-alloy or micro-alloyed structural steels.

EM2, EM3, and EM4 (High-Strength, Low Alloy Steel)

May contain a combination of Cr, Ni, Mo, Ti, Zr and Al.

EW (Weathering Steel) – Designed to produce weld metal that matches the corrosion resistance and the coloring of the ASTM weathering-type structural steels. These special properties are achieved by the addition of about 0.5% copper to the weld metal.

EG (General Low-Alloy Steel) – Indicates that the electrode is of a general classification. It is general because not all of the particular requirements specified for each of the other classifications are specified for this classification.

AWS CLASSIFICATION SYSTEM

Submerged Arc (SAW) Flux & Electrode

Mild & Low Alloy Steel - Per AWS A5.17/A5.17M and AWS A5.23/A5.23M

CLASSIFICATION DESIGNATORS PER AWS A5.17 & A5.23

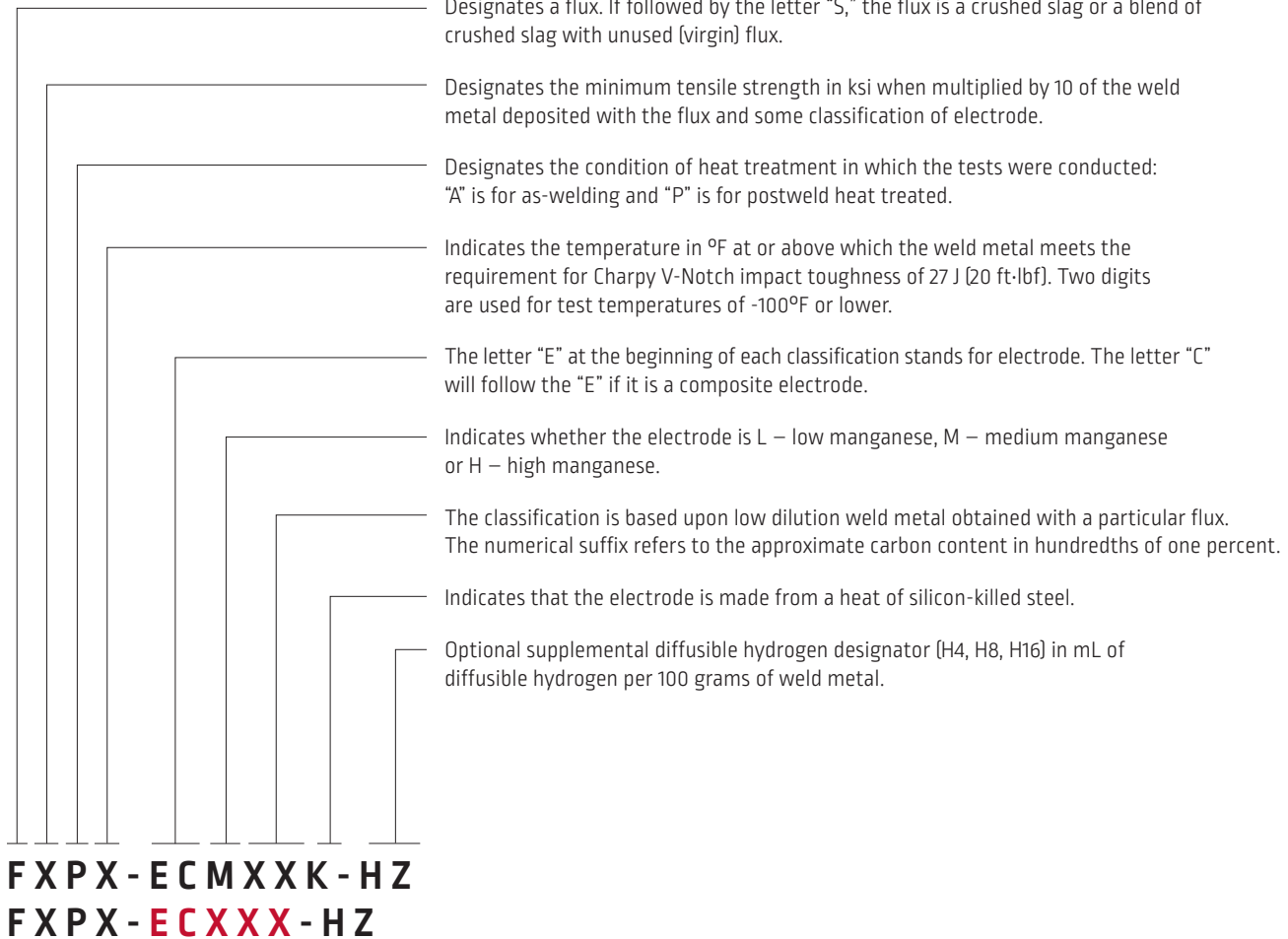

CLASSIFICATION DESIGNATORS PER AWS A5.23 ONLY

Indicates the chemical composition of a solid electrode or the undiluted weld metal obtained with a composite electrode and particular flux. Usually a combination of letters, numbers and elements (see next page).

MILD STEEL EXAMPLES

F7A6-EM12K is a complete designation for a flux-electrode combination. It refers to a flux that will produce weld metal which, in the as-welded condition, will have a tensile strength of 70,000 to 95,000 psi and Charpy V-Notch impact strength of at least 20 ft-lbf at -60°F when produced with an EM12K electrode under the conditions called for in this specification. The absence of an "S" in the second position indicates that the flux being used is a virgin flux. F7P4-EC1 is a complete designation for a flux-composite electrode combination when the trade name of the electrode used in the classification is indicated as well. It refers to a virgin flux that will produce weld metal with that electrode which, in the postweld heat treated condition, will have a tensile strength of 70,000 to 95,000 psi and Charpy V-Notch energy of at least 20 ft-lbf at -40°F under the conditions called for in this specification.

LOW ALLOY STEEL EXAMPLES

F9P0-EB3-B3 is a complete designation for a flux-electrode combination. It refers to a flux that will produce weld metal which, in the postweld heat treated condition, will have a tensile strength of 90,000 to 110,000 psi and Charpy V-Notch impact strength of at least 20 ft-lbf at 0°F when produced with an EB3 electrode under the conditions called for in this specification. The composition of the weld metal will meet the requirements for a B3 designation.

STICK ELECTRODE

Types of Coating & Current

MILD STEEL PER AWS A5.1

TYPES OF COATING & CURRENT

Digit	Types of Coating	Current
0	High cellulose sodium	DC+
1	High cellulose potassium	AC, DC±
2	High titania sodium	AC, DC-
3	High titania potassium	AC, DC+
4	Iron powder, titania	AC, DC±
5	Low-hydrogen sodium	DC+
6	Low-hydrogen potassium	AC, DC+
7	High iron oxide, iron powder	AC, DC±
8	Low-hydrogen potassium, iron powder	AC, DC±

LOW ALLOY STEEL PER AWS A5.5

TYPES OF COATING

Suffix	%C	%Mn	%Si	%P	%S	%Ni	%Cr	%Mo	%V
A1	0.12	0.60	0.40	0.03	0.03			0.40 - 0.65	
B2	0.05 - 0.12	0.90	0.80	0.03	0.03		1.00 - 1.50	0.40 - 0.65	
B3	0.05 - 0.12	0.90	0.80	0.03	0.03		2.00 - 2.50	0.90 - 1.20	
C1	0.12	1.25	0.80	0.03	0.03	2.00 - 2.75			
C3	0.12	0.40 - 1.25	0.80	0.03	0.03	0.80 - 1.10	0.15	0.35	0.05
D2	0.15	1.65 - 2.00	0.80	0.03	0.03	0.90		0.25 - 0.45	
G ⁽¹⁾		1.00 min	0.80 min	0.03	0.03	0.50 min	0.30 min	0.20 min	0.10 min
P1	0.20	1.20	0.60	0.03	0.03	1.00	0.30	0.50	0.10
P2	0.12	0.90 - 1.70	0.80	0.03	0.03	1.00	0.30	0.50	0.05

⁽¹⁾ Only one of the listed elements is required.

NOTE 1: Joining Electrodes, Non-Charpy V-Notch Rated

These electrodes (see below) and others of the same AWS classification, are not required to deposit weld metal capable of delivering any minimum specified Charpy V-Notch (CVN) properties. It should not be used in applications where minimum specified CVN properties are required. Typical applications where minimum specified CVN properties are required include, but are not restricted to, bridges, pressure vessels, and buildings in seismic zones. The user of this product is responsible for determining whether minimum CVN properties are required for the specific application.

Fleetweld® 22 Fleetweld® 37 Fleetweld® 47

NOTE 2: Joining Electrodes, Non-Low Hydrogen

These electrodes (see below) and others of the same AWS classification, are not required to deposit weld metal that is low in diffusible hydrogen. Therefore, these electrodes should not be used in applications where the hydrogen content of the weld metal is required to be controlled, such as applications that involve steels with higher carbon and alloy content, and higher strength.

Fleetweld® 5P Fleetweld® 35LS Fleetweld® 22 Shield-Arc® HYP+ Jetweld® 2 Pipeliner® 7P+
 Fleetweld® 5P+ Fleetweld® 180 Shield-Arc® 85 Fleetweld® 47 Shield-Arc® 70+ Pipeliner® 8P+
 Fleetweld® 35 Fleetweld® 37 Shield-Arc® 90 Jetweld® 1 Pipeliner® 6P+

STICK ELECTRODE

ASME Boiler & Pressure Vessel Code

ASME BOILER & PRESSURE VESSEL CODE

Section IX - F and A No.'s for Stick Electrode			
F Number (per ASME Section IX and AWS D1.1)	AWS Classifications	Product	Weld Metal Analysis Classification (per ASME Section IX)
F-1	EXX20, EXX24, EXX27, EXX28, EXX20-X, EXX27-X	Fleetweld® 22 Jetweld® 2 Jetweld® 1 Excalibur® 7028	– A1 A1 A1
F-2	EXX12, EXX13, EXX14, EXX13-X	Fleetweld® 37 Fleetweld® 47	A1 A1
F-3	EXX10, EXX11, EXX10-X, EXX11-X	Fleetweld® 5P Fleetweld® 5P+ Pipeliners® 6P+ Fleetweld® 35 Fleetweld® 35LS Fleetweld® 180 Shield-Arc® 85 Shield-Arc® 70+ Shield-Arc® 90 Shield-Arc® HYP+ Pipeliners® 7P+ Pipeliners® 8P+	A1 A1 A1 A1 A1 A1 A2 – A11 – – –
F-4	EXX15, EXX16, EXX18, EXX45-X, EXX15-X, EXX16-X, EXX18-X	Jetweld® LH-70 Jet-LH® 78 Lincoln® 7018AC Excalibur® 7018 MR Excalibur® 7018-1 MR Excalibur® 7018-A1 MR Excalibur® 8018-B2 MR Excalibur® 8018-C1 MR Excalibur® 8018-C3 MR Excalibur® 9018-B3 MR Excalibur® 9018M MR Excalibur® 10018-D2 MR Excalibur® 11018M MR Pipeliners® 16P Pipeliners® 18P Pipeliners® 19P Pipeliners® LH-D80 Pipeliners® LH-D90 Pipeliners® LH-D100	A1 A1 A1 A1 A1 A2 A3 A10 A10 A4 A10 A11 – A1 A10 A10 A1 – –

SUBMERGED ARC FLUXES

Flux Types and General Characteristics

The Lincoln Electric Company manufactures three general types of submerged arc fluxes:

- *Active fluxes*
- *Neutral fluxes*
- *Alloy fluxes*

With all submerged arc fluxes, variations in arc voltage change flux consumption. Higher arc voltages and the resulting longer arc length increase the amount of flux melted or consumed. Consequently, when a flux contains an alloy as an ingredient, increasing the arc voltage increases the amount of alloy recovered in the weld deposit.

Types and General Characteristics

ACTIVE FLUXES

American Welding Society (AWS) defines active fluxes as those which contain small amounts of manganese, silicon, or both. These deoxidizers are added to the flux to provide improved resistance to porosity and weld cracking caused by contaminants on or in the base metal.

The primary use for active fluxes is to make single pass welds, especially on oxidized base metal.

Alloy in the weld deposit will vary with changes in the arc voltage. An increase in deposit alloy increases the strength level of the weld metal, but might lower the impact properties. For this reason, voltage must be more tightly controlled for multiple pass welding with active fluxes than when using neutral fluxes. Because of this, Lincoln Electric does not recommend using active fluxes (our 700 series) for multiple pass welding of plates over 25 mm (1 in) thick.

NEUTRAL FLUXES

AWS defines neutral fluxes as those which will not produce any significant change in the all-weld metal composition as a result of a large change in the arc voltage, and thus, the arc length.

Neutral fluxes are used in multiple pass welding, especially when the base plate exceeds 25 mm (1 in) in thickness. They are also used for general welding on clean steel. Note the following considerations concerning neutral fluxes:

1. Since neutral fluxes contain little or no alloy, they have little resistance to cracking and/or porosity caused by contaminants, especially on single pass welds. For this reason, active fluxes are usually the best choice for single pass welding.
2. Even when a neutral flux is used to maintain the weld metal composition through a range of welding voltage, weld properties, such as strength level and impact properties, can change because of changes in cooling rate, penetration, heat input and number of passes.

ALLOY FLUXES

AWS defines alloy fluxes as those which can be used with a plain carbon steel electrode to make an alloy weld deposit. The alloys for the weld deposit are added as ingredients in flux.

The primary use of alloy fluxes is hardfacing applications.

Since the alloy level in the weld deposit is dependent upon the correct arc voltage, and thus arc length, it is very important that the voltage is carefully controlled to ensure that the intended alloy is reached in the deposit.

SUBMERGED ARC FLUX/WIRE

Selecting Flux/Wire Combinations

Guidelines for Selecting a Submerged Arc Flux/Wire Combination

Lincolnweld® submerged arc electrode and flux combinations come with certificates of conformance. To access these certificates, follow the directions below.

1. Go to the Lincoln Electric home page at www.lincolnelectric.com.
2. Click on the 'Resource' tab and select 'Certificate Center' from the drop down. (Image 1)
3. Under 'Filler Metal Certification,' go to Q1 lots and then you can choose a Product or a Flux Combination. This will bring up the most recent Certificate of Conformance. (Image 2)

How to look for flux/wire combinations that meet your required mechanical properties:

TENSILE STRENGTH

1. In the second box under 'Certificates of Conformance,' you can 'Search by Name/ Cert # / Classification.'
2. Enter F#P or F#A. Where # is 10X the required Tensile Strength in ksi. P= Stress Relieved, A= As-Welded.
 - a. *For example, entering F7P would mean you are looking for a flux/wire combination with 70 ksi Tensile Strength in the Stress Relieved Condition.*

IMPACT REQUIREMENTS

1. In the list of matches for your required Tensile Strength, you can see which Flux/Wire Combinations also meet your Impact Property Requirements.
2. If you need to meet Impact Requirements at a certain value, note that the digit following the "A" or "P" in the classifications shows the temperature at which the weld metal achieves a minimum of 27 J [20 ft-lbf).
 - a. *For example, a classification beginning with F7P2 would mean that the flux/wire combination meets 70 ksi Tensile Strength in the Stress Relieved Condition and Impact Requirements of 27 J [20 ft-lbf] @ -29°C [-20°F].*

In general, if you are familiar with one of the listed fluxes, you might want to choose that option. From an operator's standpoint, it is easier to change electrodes than to reset procedures for a new flux.

If you are welding high strength or highly restrained steel, you might want to choose a Flux/Wire Combination with a lower diffusible hydrogen level, which is designated by the number following -H in the flux/wire classification.

If you have limits on the compositions of the electrode or the weld metal, click on a Flux/Wire Combination to see the test results. Remember that these results represent undiluted weld metal from a standardized test and may be different from your application, especially if variations in base metal, heat input or pass sequence are present.

Your Lincoln Electric Technical Sales Representatives are there to help you make the best flux/wire selection for your application. Please contact them with any questions.

SUBMERGED ARC FLUX/WIRE

Selecting Flux/Wire Combinations

Guidelines for Selecting a Submerged Arc Flux/Wire Combination

Image 1:

At the Lincoln Electric home page select "Certificate Center" from the drop down menu under the 'Support' tab.

Image 2:

At the Certificate Center, enter a product name or search by Name, Cert #, or Classification. Search results will appear below.

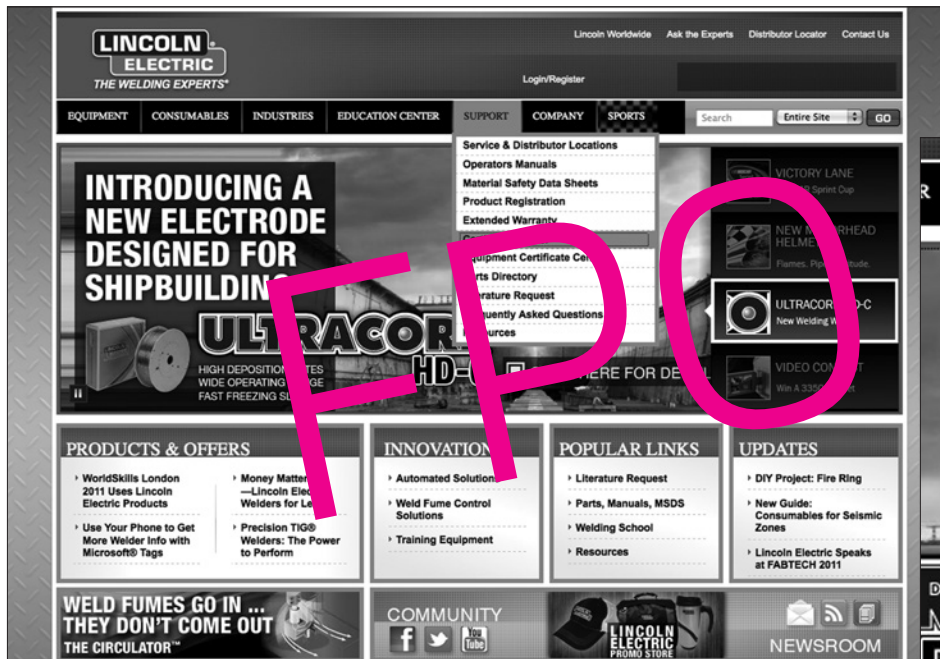

Image 1

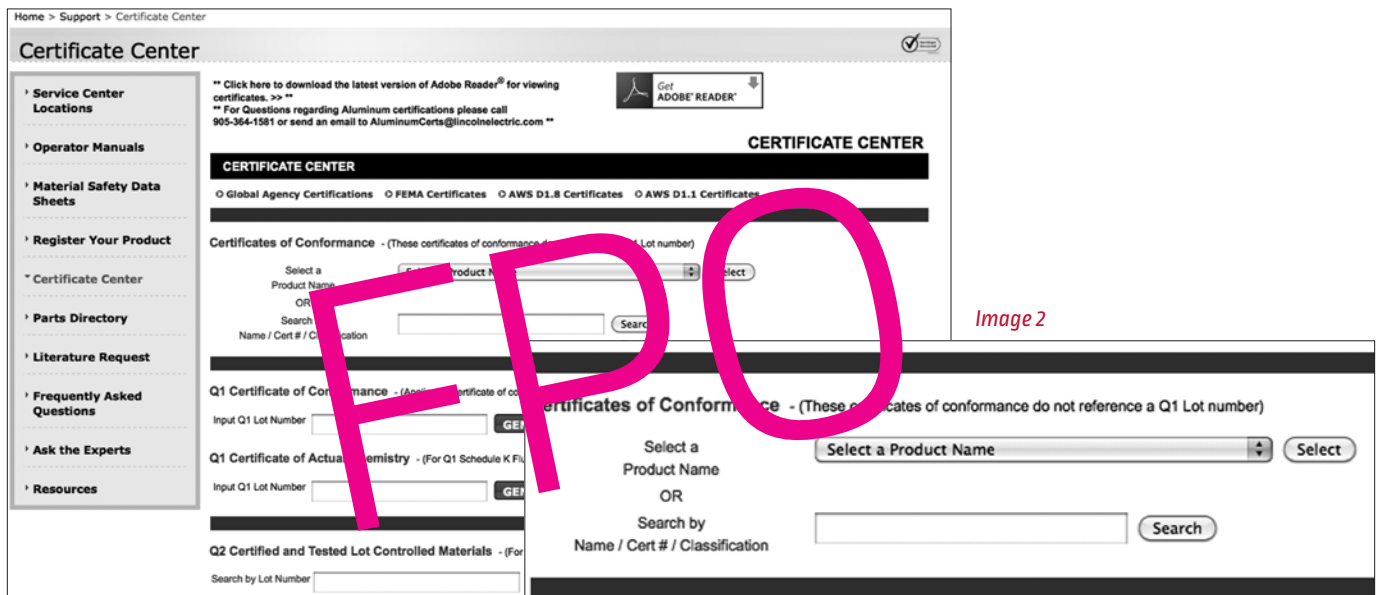
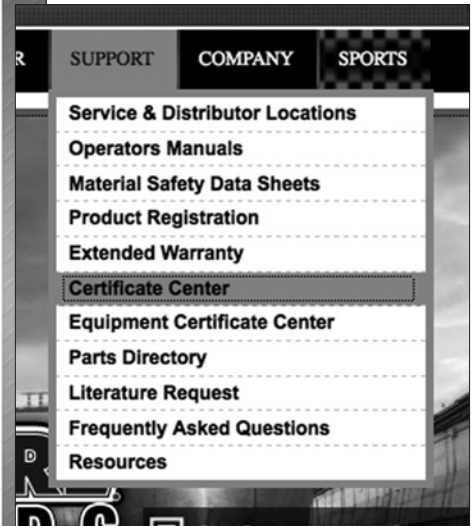

Image 2

INNERSHIELD[®]

Wire Selection Guide

POSITION OF WELDING, POLARITY AND APPLICATION REQUIREMENTS

AWS Classifications	Welding Position ⁽¹⁾	Current	Application ⁽²⁾
E70T-3	H and F	DC+	S
E70T-4	H and F	DC+	M
E70T-6	H and F	DC+	M
E70T-7	H and F	DC-	M
E71T-8	H, F, VU, OH	DC-	M
E70T-10	H and F	DC-	S
E71T-11	H, F, VD, OH	DC-	M
E71T-14	H, F, VD, OH	DC-	S
E71T-G	VU, OH	Not Specified	M

⁽¹⁾ H = Horizontal position
F = Flat position

OH = Overhead position
VU = Vertical-Up position

VD = Vertical-Down position
⁽²⁾ S = Single pass only

M = Single or Multiple pass

FOR EVERYTHING YOU NEED TO KNOW ABOUT WELDING IN SEISMIC ZONES

To assist structural fabricators, erectors, inspectors and specifying engineers, Lincoln Electric created this D1.8 Resource Center with tools to understand seismic welding guidelines and links to Lincoln Electric consumables tested to meet the AWS D1.8 and FEMA

353 requirements. The development of Lincoln Electric's D1.8 Resource Center is just one more way Lincoln sets the standard for the welding industry, worldwide.



www.lincolnelectric.com/LEExtranet/MyLincolnCerts/site/awsd.aspx

INNERSHIELD®

Wire Selection Guide

LOW TEMPERATURE IMPACT PROPERTIES

Name	AWS Classifications	Diameter in (mm)
All Position		
NR® -203MP	E71T-8J	0.068 (1.7) 5/64 (2.0)
NR®-203 Nickel (1%)	E71T8-Ni1	5/64 (2.0)
NR®-440Ni2	E71T8-Ni2-JH8	5/64 (2.0)
NR®-203 Ni C Plus H	E71T8-K2	5/64 (2.0)
NR®-232	E71T-8	0.068 (1.7) 0.072 (1.8) 5/64 (2.0)
NR®-233	E71T-8	1/16 (1.6) 0.072 (1.8) 5/64 (2.0)
Flat and Horizontal		
NR®-305	E70T-6	5/64 (2.0) 3/32 (2.4)
NR®-311 Ni	E70T-7-K2	5/64 (2.0) 3/32 (2.4) 7/64 (2.8)

FEMA 353 AND AWS D1.8 COMPLIANT

Name	AWS Classifications	Diameter in (mm)
Flat and Horizontal		
NR®-311 Ni	E70T-7-K2	3/32 (2.4)
NR®-305	E70T-6	5/64 (2.0) 3/32 (2.4)
All Position		
NR®-232	E71T-8	0.068 (1.7) 0.072 (1.8) 5/64 (2.0)
NR®-233	E71T-8	1/16 (1.6) 0.072 (1.8) 5/64 (2.0)

HIGH DEPOSITION WITH NO LOW TEMPERATURE IMPACT PROPERTIES

Name	AWS Classifications	Diameter in (mm)
Flat and Horizontal		
NR®-311	E70T-7	5/64 (2.0) 3/32 (2.4) 7/64 (2.8)
NS-3M	E70T-4	5/64 (2.0) 3/32 (2.4) 0.120 (2.8)

SINGLE PASS ONLY WITH NO LOW TEMPERATURE IMPACT PROPERTIES

Name	AWS Classifications	Diameter in (mm)
Flat and Horizontal		
NR®-5	E70T-3	3/32 (2.4) 0.0120 (3.0)
NR®-131	E70T-10	3/32 (2.4)
NR®-152	E71T-14	1/16 (1.6) 0.068 (1.7)

PIPE FABRICATION

Name	AWS Classifications	Diameter in (mm)
All Position		
NR®-207	E71T8-K6	0.068 (1.7) 5/64 (2.0)
NR®-208-H	E91T8-G-H8	5/64 (2.0)
Pipeliners®		
All Position		
NR®-208-XP	E81T8-G	5/64 (2.0)
NR®-207+	E71T-8-K6	5/64 (2.0)

GENERAL FABRICATION WITH NO LOW TEMPERATURE IMPACT PROPERTIES

Name	AWS Classifications	Diameter in (mm)
All Position		
NR®-211-MP	E71T-11	0.030 (0.8) 0.035 (0.9) 0.045 (1.1) 0.068 (1.7) 5/64 (2.0) 3/32 (2.4)
NR®-212	E71TG-G	0.045 (1.1) 0.068 (1.7) 5/64 (2.0)

HARDFACING

Cross Checking

Special precautions should be taken with any build-up or hardfacing product on applications that are inherently crack sensitive, such as high carbon or alloy steels, previously hardfaced parts, highly stressed parts, and work hardened parts. The hardfacing of heavy cylinders, massive parts and parts having complex shapes are all examples of applications exhibiting high internal stresses that may result in delayed cracking.

These applications may require one or more of the following:

- Higher preheat temperatures
- Higher interpass temperatures
- Controlled slow cooling between passes and/or layers
- Stress relieving
- Minimizing layer thickness

The table below will help determine if special precautions need to be taken with specific Lincore® wires:

SPECIAL PRECAUTIONS

Product	Lincore® Products								
	55	55-G	65-0	60-0	30-S	32-S	35-S	40-S	42-S
Higher Preheat Temp.⁽¹⁾ 150°C - 260°C (300°F - 500°F) 200°C - 260°C (400°F - 500°F)	✓	✓	✓	✓					
					✓	✓	✓	✓	✓
Higher Interpass Temp. 200°C - 320°C (400°F-600°F)	✓	✓	✓	✓	✓	✓	✓	✓	✓
Controlled Cooling Between Passes/Layers	✓	✓	✓	✓	✓	✓	✓	✓	✓
Stress Relieving 430°C - 480°C (800°F - 900°F)⁽²⁾ Every 6.4 mm (1/4 in) Thickness of Deposit Every 10-13 mm (3/8 - 1/2 in) Thickness of Deposit	✓	✓							
			✓	✓	✓				
Minimize Layer Thickness			✓		✓	✓	✓	✓	✓

⁽¹⁾Preheat depends on the base material chemistry and thickness, as well as the weld metal chemistry.

⁽²⁾Stress relieving in temperatures in excess of 482°C (900°F) will result in a "softening" of the deposit.

AGENCY APPROVALS

Consumables Qualifications Guide

The notes and codes listed below are also repeated throughout the catalog where applicable.

- **American Bureau of Shipping (ABS)** approvals are issued subject to the Bureau's Rule requirement for Materials and Welding Part 2. Tests are conducted in the company's plant, under supervision of an ABS surveyor to determine if electrodes conform to ABS grades or AWS specifications previously judged satisfactory by ABS for welding vessels. The Bureau publishes a list of approved electrodes giving their class and approved operating positions for each size. Sometimes, where there is no approved specification, approval may be given on the basis that each individual shipyard or contractor will qualify the procedure and electrode subject to Part 2, Section 3, paragraph 2/B.C.3.2.c.
- **American Society of Mechanical Engineers (ASME)** has issued specifications covering construction of nuclear facilities. Each lot of welding consumables to be used must be individually tested to ASME SFA specifications.
- **American Welding Society (AWS)** specifications and classifications are established by the Society to provide standards for different types of electrodes throughout the industry. AWS does not test or approve any electrodes. The manufacturer certifies that their electrode conforms to a certain class.
- **Canadian Welding Bureau (CWB)** approvals are based on tests witnessed by a CWB representative. Approvals listed in this booklet are for products manufactured in the USA. Products manufactured in Canada are approved separately. In general, CWB specifications are similar to AWS specifications. Copies of approvals are maintained in Cleveland and are available upon request.
- **Lloyd's Register (LR), Det Norske Veritas (DNV), Germanischer Lloyd (GL), Bureau Veritas (BV), Controlas, and Nippon Kaiji Kyokai (NKK)** issue approvals for electrodes used worldwide in shipbuilding, offshore structures and pressure vessels. Products approved under the rules of these classification societies require annual requalification under the supervision of their surveyors.
- **TÜV (TUV)** is a German agency very similar to ASME. Projects manufactured under TUV rules must be welded with consumable approved by TUV. Initial approvals are obtained based on testing completed under TUV supervision. Approvals are maintained subject to Quality Assurance audits completed every two years.
- **Deutsche Bahn (DB)** is the approval agency for German railroads. Approvals are based on tests specified by DB, and witnessed by an authorized third party.

SAFETY GUIDELINES



WARNING



CALIFORNIA PROPOSITION 65 WARNINGS



FOR DIESEL ENGINES

Diesel engine exhaust and some of its constituents are known to the State of California to cause cancer, birth defects, and other reproductive harm.

FOR GASOLINE ENGINES

The engine exhaust from this product contains chemicals known to the State of California to cause cancer, birth defects, or other reproductive harm.

ARC WELDING CAN BE HAZARDOUS. PROTECT YOURSELF AND OTHERS FROM POSSIBLE SERIOUS INJURY OR DEATH. KEEP CHILDREN AWAY. PACEMAKER WEARERS SHOULD CONSULT WITH THEIR DOCTOR BEFORE OPERATING.

Read and understand the following safety highlights. For additional safety information, it is strongly recommended that you purchase a copy of "Safety in Welding & Cutting - ANSI Standard Z49.1" from the American Welding Society, P.O. Box 351040, Miami, Florida 33135 or CSA Standard W117.2-1974. A Free copy of "Arc Welding Safety" booklet E205 is available from the Lincoln Electric Company, 22801 St. Clair Avenue, Cleveland, Ohio 44117-1199.

BE SURE THAT ALL INSTALLATION, OPERATION, MAINTENANCE AND REPAIR PROCEDURES ARE PERFORMED ONLY BY QUALIFIED INDIVIDUALS.



FOR ENGINE POWERED EQUIPMENT.



1.a. Turn the engine off before troubleshooting and maintenance work unless the maintenance work requires it to be running.

1.b. Operate engines in open, well-ventilated areas or vent the engine exhaust fumes outdoors.



1.c. Do not add the fuel near an open flame welding arc or when the engine is running. Stop the engine and allow it to cool before refueling to prevent spilled fuel from vaporizing on contact with hot engine parts and igniting. Do not spill fuel when filling tank. If fuel is spilled, wipe it up and do not start engine until fumes have been eliminated.



1.d. Keep all equipment safety guards, covers and devices in position and in good repair. Keep hands, hair, clothing and tools away from V-belts, gears, fans and all other moving parts when starting, operating or repairing equipment.

1.e. In some cases it may be necessary to remove safety guards to perform required maintenance. Remove guards only when necessary and replace them when the maintenance requiring their removal is complete. Always use the greatest care when working near moving parts.



1.f. Do not put your hands near the engine fan. Do not attempt to override the governor or idler by pushing on the throttle control rods while the engine is running.

1.g. To prevent accidentally starting gasoline engines while turning the engine or welding generator during maintenance work, disconnect the spark plug wires, distributor cap or magneto wire as appropriate.

1.h. To avoid scalding, do not remove the radiator pressure cap when the engine is hot.



REFER TO [HTTP://WWW.LINCOLNELECTRIC.COM/SAFETY](http://www.lincolnelectric.com/safety) FOR ADDITIONAL SAFETY INFORMATION.

SAFETY GUIDELINES

ELECTRIC AND MAGNETIC FIELDS MAY BE DANGEROUS

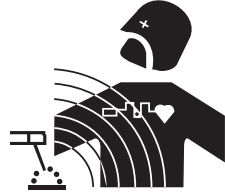

- 2.a. Electric current flowing through any conductor causes localized Electric and Magnetic Fields (EMF). Welding current creates EMF fields around welding cables and welding machines
- 2.b. EMF fields may interfere with some pacemakers, and welders having a pacemaker should consult their physician before welding.

- 2.c. Exposure to EMF fields in welding may have other health effects which are now not known.
- 2.d. All welders should use the following procedures in order to minimize exposure to EMF fields from the welding circuit:
- 2.d.1. Route the electrode and work cables together - Secure them with tape when possible.
 - 2.d.2. Never coil the electrode lead around your body.
 - 2.d.3. Do not place your body between the electrode and work cables. If the electrode cable is on your right side, the work cable should also be on your right side.
 - 2.d.4. Connect the work cable to the workpiece as close as possible to the area being welded.
 - 2.d.5. Do not work next to welding power source.

ELECTRIC SHOCK CAN KILL



- 3.a. The electrode and work (or ground) circuits are electrically "hot" when the welder is on. Do not touch these "hot" parts with your bare skin or wet clothing. Wear dry, hole-free gloves to insulate hands.
- 3.b. Insulate yourself from work and ground using dry insulation. Make certain the insulation is large enough to cover your full area of physical contact with work and ground. In addition to the normal safety precautions, if welding must be performed under electrically hazardous conditions (in damp locations or while wearing wet clothing; on metal structures such as floors, gratings or scaffolds; when in cramped positions such as sitting, kneeling or lying, if there is a high risk of unavoidable or accidental contact with the workpiece or ground) use the following equipment:
- Semiautomatic DC Constant Voltage (Wire) Welder.
 - DC Manual (Stick) Welder.
 - AC Welder with Reduced Voltage Control.

- 3.c. In semiautomatic or automatic wire welding, the electrode, electrode reel, welding head, nozzle or semiautomatic welding gun are also electrically "hot".
- 3.d. Always be sure the work cable makes a good electrical connection with the metal being welded. The connection should be as close as possible to the area being welded.
- 3.e. Ground the work or metal to be welded to a good electrical (earth) ground.
- 3.f. Maintain the electrode holder, work clamp, welding cable and welding machine in good, safe operating condition. Replace damaged insulation.
- 3.g. Never dip the electrode in water for cooling.
- 3.h. Never simultaneously touch electrically "hot" parts of electrode holders connected to two welders because voltage between the two can be the total of the open circuit voltage of both welders.
- 3.i. When working above floor level, use a safety belt to protect yourself from a fall should you get a shock.
- 3.j. Also see Items 6.c. and 8.

REFER TO [HTTP://WWW.LINCOLNELECTRIC.COM/SAFETY](http://www.lincolnelectric.com/safety) FOR ADDITIONAL SAFETY INFORMATION.

SAFETY GUIDELINES

ARC RAYS CAN BURN

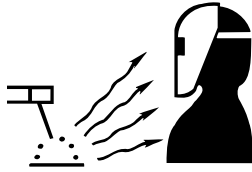

4.a. Use a shield with the proper filter and cover plates to protect your eyes from sparks and the rays of the arc when welding or observing open arc welding. Headshield and filter lens should conform to ANSI Z87.1 standards.

4.b. Use suitable clothing made from durable flame-resistant material to protect your skin and that of your helpers from the arc rays.

4.c. Protect other nearby personnel with suitable, non-flammable screening and/or warn them not to watch the arc nor expose themselves to the arc rays or to hot spatter or metal.

FUMES AND GASES CAN BE DANGEROUS

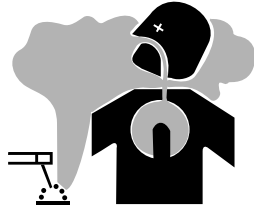

5.a. Welding may produce fumes and gases hazardous to health. Avoid breathing these fumes and gases. When welding, keep your head out of the fume. Use enough ventilation and/or exhaust at the arc to keep fumes and gases away from the breathing zone. When welding with electrodes which require special ventilation such as stainless or hard facing (see instructions on container or MSDS) or on lead or cadmium plated steel and other metals or coatings which produce highly toxic fumes, keep exposure as low as possible and within applicable OSHA PEL and ACGIH TLV limits using local exhaust or mechanical ventilation. In confined spaces or in some circumstances, outdoors, a respirator may be required. Additional precautions are also required when welding on galvanized steel.

5.b. The operation of welding fume control equipment is affected by various factors including proper use and positioning of the equip-

ment, maintenance of the equipment and the specific welding procedure and application involved. Worker exposure level should be checked upon installation and periodically thereafter to be certain it is within applicable OSHA PEL and ACGIH TLV limits.

5.c. Do not weld in locations near chlorinated hydrocarbon vapors coming from degreasing, cleaning or spraying operations. The heat and rays of the arc can react with solvent vapors to form phosgene, a highly toxic gas, and other irritating products.

5.d. Shielding gases used for arc welding can displace air and cause injury or death. Always use enough ventilation, especially in confined areas, to insure breathing air is safe.

5.e. Read and understand the manufacturer's instructions for this equipment and the consumables to be used, including the materialsafety data sheet (MSDS) and follow your employer's safety practices. MSDS forms are available from your welding distributor or from the manufacturer.

5.f. Also see item 1.b.

REFER TO [HTTP://WWW.LINCOLNELECTRIC.COM/SAFETY](http://www.lincolnelectric.com/safety) FOR ADDITIONAL SAFETY INFORMATION.

SAFETY GUIDELINES

WELDING AND CUTTING SPARKS CAN CAUSE FIRE OR EXPLOSION

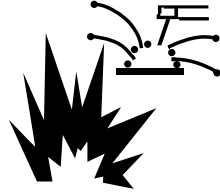

- 6.a. Remove fire hazards from the welding area. If this is not possible, cover them to prevent the welding spark from starting a fire. Remember that welding sparks and hot materials from welding can easily go through small cracks and openings to adjacent areas. Avoid welding near hydraulic lines. Have a fire extinguisher readily available.
- 6.b. Where compressed gases are to be used at the job site, special precautions should be used to prevent hazardous situations. Refer to "Safety in Welding and Cutting" (ANSI Standard Z49.1) and the operating information for the equipment being used.
- 6.c. When not welding, make certain no part of the electrode circuit is touching the work or ground. Accidental contact can cause overheating and create a fire hazard.
- 6.d. Do not heat, cut or weld tanks, drums or containers until the proper steps have been taken to insure that such procedures will not cause flammable or toxic vapors from substances inside. They can cause an explosion even though they have been "cleaned". For information, purchase "Recommended Safe Practices for the Preparation for Welding and Cutting of Containers and Piping That Have Held Hazardous Substances", AWS F4.1 from the American Welding Society (see address above).
- 6.e. Vent hollow castings or containers before heating, cutting or welding. They may explode.
- 6.f. Sparks and spatter are thrown from the welding arc. Wear oil free protective garments such as leather gloves, heavy shirt, cuffless trousers, high shoes and a cap over your hair. Wear ear plugs when welding out of position or in confined places. Always wear safety glasses with side shields when in a welding area.
- 6.g. Connect the work cable to the work as close to the welding area as practical. Work cables connected to the building framework or other locations away from the welding area increase the possibility of the welding current passing through lifting chains, crane cables or other alternate circuits. This can create fire hazards or overheat lifting chains or cables until they fail.
- 6.h. Also see item 1.c.
- 6.i. Read and follow NFPA 51B "Standard for Fire Prevention During Welding, Cutting and Other Hot Work", available from NFPA, 1 Batterymarch Park, PO box 9101, Quincy, Ma 022690-9101.
- 6.j. Do not use a welding power source for pipe thawing.

REFER TO [HTTP://WWW.LINCOLNELECTRIC.COM/SAFETY](http://www.lincolnelectric.com/safety) FOR ADDITIONAL SAFETY INFORMATION.

SAFETY GUIDELINES

CYLINDER MAY EXPLODE IF DAMAGED

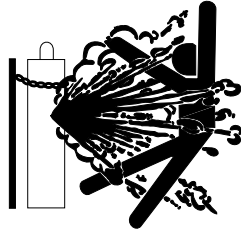

- 7a. Use only compressed gas cylinders containing the correct shielding gas for the process used and properly operating regulators designed for the gas and pressure used. All hoses, fittings, etc. should be suitable for the application and maintained in good condition.
- 7b. Always keep cylinders in an upright position securely chained to an undercarriage or fixed support.
- 7c. Cylinders should be located:
 - Away from areas where they may be struck or subjected to physical damage.
 - A safe distance from arc welding or cutting operations and any other source of heat, sparks, or flame.
- 7d. Never allow the electrode, electrode holder or any other electrically "hot" parts to touch a cylinder.
- 7e. Keep your head and face away from the cylinder valve outlet when opening the cylinder valve.
- 7f. Valve protection caps should always be in place and hand tight except when the cylinder is in use or connected for use.
- 7g. Read and follow the instructions on compressed gas cylinders, associated equipment, and CGA publication P-1, "Precautions for Safe Handling of Compressed Gases in Cylinders," available from the Compressed Gas Association 1235 Jefferson Davis Highway, Arlington, VA 22202.

FOR ELECTRICALLY POWERED EQUIPMENT



- 8.a. Turn off input power using the disconnect switch at the fuse box before working on the equipment.
- 8.b. Install equipment in accordance with the U.S. National Electrical Code, all local codes and the manufacturer's recommendations.
- 8.c. Ground the equipment in accordance with the U.S. National Electrical Code and the manufacturer's recommendations.

REFER TO [HTTP://WWW.LINCOLNELECTRIC.COM/SAFETY](http://www.lincolnelectric.com/safety) FOR ADDITIONAL SAFETY INFORMATION.

SAFETY GUIDELINES

Safety Practices in Welding



FUMES AND GASES CAN BE DANGEROUS TO YOUR HEALTH

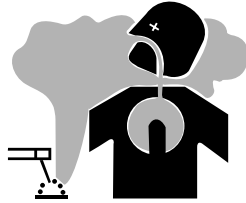

- *Keep fumes and gases from your breathing zone and general area.*
- *Keep your head out of the fumes.*
- *Use enough ventilation or exhaust at the arc, or both, to keep fumes and gases from your breathing zone and general area.*

Fumes and Gases

Because of the variables involved in fume and gas generation from arc welding, cutting and allied processes (such as the welding process and electrode, the base metal, coatings on the base metal, and other possible contaminants in the air), we'll have to treat the subject in a rather general way, lumping all but the more hazardous situations together. The precautions we describe will hold true for all arc welding processes.

The **fume plume** contains solid particles from the consumables, base metal, and base metal coating. For common mild steel arc welding, depending on the amount and length of exposure to these fumes, most immediate or short term effects are temporary, and include symptoms of burning eyes and skin, dizziness, nausea, and fever. For example, zinc fumes can cause metal fume fever, a temporary illness that is similar to the flu.

Long-term exposure to welding fumes can lead to siderosis (iron deposits in the lungs) and may affect pulmonary function. Bronchitis and some lung fibrosis have been reported.

Some consumables contain certain compounds in amounts which may require special ventilation and/or exhaust. These Special Ventilation products can be identified by reading the labels on the package. If Special Ventilation products are used indoors, use local exhaust. If Special Ventilation products are used outdoors, a respirator may be required. Various compounds, some of which may be in welding fume, and reported health effects, in summary, are:

Barium: Soluble barium compounds may cause severe stomach pain, slow pulse rate, irregular heart beat, ringing of the ears, convulsions and muscle spasms. In extreme cases can cause death.

Cadmium: Cadmium also requires extra precautions. This toxic metal can be found on some steel and steel fasteners as a plating, or in silver solder. Cadmium fumes can be fatal even under brief overexposures, with symptoms much like those of metal fume fever. These two conditions should not be confused. Overexposure to cadmium can be enough to cause fatalities, with symptoms appearing quickly, and, in some circumstances, death a few days later.

Chromium: Chromium is on the IARC (International Agency for Research on Cancer) and NTP (National Toxicology Program) lists chromium as posing a carcinogenic risk to humans. Fumes from the use of stainless steel, hardfacing and other types of consumables contain chromium and/or nickel. Some forms of these metals are known or suspected to cause lung cancer in processes other than welding and asthma has been reported. Therefore, it is recommended that precautions be taken to keep exposures as low as possible. OSHA recently adopted a lower PEL (Permissible Exposure Limit) for chromium (see Supplement 3). The use of local exhaust and/or an approved respirator may be required to avoid overexposure.

Coatings on the metal to be welded, such as paint, may also contain toxic substances, such as lead, chromium and zinc. In general, it is always best to remove coatings from the base metal before welding or cutting.

Cobalt: Exposure to cobalt can cause respiratory disease and pulmonary sensitization. Cobalt in metallic form has been reported to cause lung damage.

Copper: Prolonged exposure to copper fume may cause skin irritation or discoloration of the skin and hair.

Manganese: Manganese overexposure may affect the central nervous system, resulting in poor coordination, difficulty in speaking, and tremor of arms or legs. This condition is considered irreversible.

Nickel: Nickel and its compounds are on the IARC (International Agency for Research on Cancer) and NTP (National Toxicology Program) lists as posing a carcinogenic risk to humans.

Silica: Crystalline silica is present in respirable dust form submerged arc flux. Overexposure can cause severe lung damage (silicosis).

Zinc: Overexposure to zinc (from galvanized metals) may cause metal fume fever with symptoms similar to the common flu.

The gases that result from an arc welding process also present potential hazard.

Most of the shielding gases (argon, helium, and carbon dioxide) are non-

REFER TO [HTTP://WWW.LINCOLNELECTRIC.COM/SAFETY](http://www.lincolnelectric.com/safety) FOR ADDITIONAL SAFETY INFORMATION.

SAFETY GUIDELINES

Safety Practices in Welding

toxic, but, as they are released, they **displace oxygen** in your breathing air, causing dizziness, unconsciousness, and death, the longer your brain is denied the oxygen it needs. Carbon monoxide can also be developed and may pose a hazard if excessive levels are present.

The heat and UV radiation can cause irritation to the eyes and lungs.

Some degreasing compounds such as trichlorethylene and perchlorethylene can decompose from the heat and ultraviolet radiation of an arc. Because of the chemical breakdown of vapor-degreasing materials under ultraviolet radiation, arc welding should not be done in the vicinity of a vapor-degreasing operation. Carbon-arc welding, gas tungsten-arc welding and gas metal arc welding should be especially avoided in such areas, because they emit more ultraviolet radiation than other processes. Also, keep in mind that ozone and nitrogen oxides are formed when UV radiation passes through the air. These gases cause headaches, chest pains, irritation of the eyes, and an itchiness in the nose and throat.

There is one easy way to reduce the risk of exposure to hazardous fumes and gases: keep your head out of the fume plume!

As obvious as this sounds, the failure to follow this advice is a common cause of fume and gas overexposure because the concentration of fume and gases is greatest in the plume. Keep fumes and gases from your breathing zone and general area using natural ventilation, mechanical ventilation, fixed or moveable exhaust hoods or local exhaust at the arc. Finally, it may be necessary to wear an approved respirator if adequate ventilation cannot be provided.

As a rule of thumb, for many mild steel electrode, if the air is visibly clear and you are comfortable, then the ventilation is generally adequate for your work. The most accurate way to determine if the worker exposure does not exceed the applicable exposure limit for compounds in the fumes and gases is to have an industrial hygienist take and analyze a sample of the air you are breathing. This is particularly important if you are welding with stainless, hardfacing

or Special Ventilation products. All Lincoln MSDS have a maximum fume guideline number. If exposure to total fume is kept below that number, exposure to all fume from the electrode (not coatings or plating on the work) will be below the TLV.

There are also steps that you can take to identify hazardous substances in your welding environment. First, read the product label and material safety data sheet for the electrode posted in the work place or in the electrode or flux container to see what fumes can be reasonably expected from use of the product and to determine if special ventilation is needed. Secondly, know what the base metal is, and determine if there is any paint, plating, or coating that could expose you to toxic fumes and/or gases. Remove it from the metal being welded, if possible. If you start to feel uncomfortable, dizzy or nauseous, there is a possibility that you are being overexposed to fumes and gases, or suffering from oxygen deficiency. Stop welding and get some fresh air immediately. Notify your supervisor and co-workers so the situation can be corrected and other workers can avoid the hazard. Be sure you are following these safe practices, the consumable labeling and MSDS and improve the ventilation in your area. Do not continue welding until the situation has been corrected.

NOTE: THE MSDS FOR ALL LINCOLN CONSUMABLES IS AVAILABLE ON LINCOLN'S WEBSITE: WWW.LINCOLNELECTRIC.COM

Before we turn to the methods available to control welding fume exposure, you should understand a few basic terms:

Natural Ventilation is the movement of air through the workplace caused by natural forces. Outside, this is usually the wind. Inside, this may be the flow of air through open windows and doors.

Mechanical Ventilation is the movement of air through the workplace caused by an electrical device such as a portable fan or permanently mounted fan in the ceiling or wall.

Source Extraction (Local Exhaust) is a mechanical device used to capture welding fume at or near the arc and filter contaminants out of the air.

REFER TO [HTTP://WWW.LINCOLNELECTRIC.COM/SAFETY](http://WWW.LINCOLNELECTRIC.COM/SAFETY) FOR ADDITIONAL SAFETY INFORMATION.

SAFETY GUIDELINES

Safety Practices in Welding

The ventilation or exhaust needed for your application depends upon many factors such as:

- *Workspace volume*
- *Workspace configuration*
- *Number of welders*
- *Welding process and current*
- *Consumables used (mild steel, hardfacing, stainless, etc.)*
- *Allowable levels (TLV, PEL, etc.)*
- *Material welded (including paint or plating)*
- *Natural airflow*

Your work area has adequate ventilation when there is enough ventilation and/or exhaust to control worker exposure to hazardous materials in the welding fumes and gases so the applicable limits for those materials is not exceeded. See the MSDS for the legal limits, the OSHA PEL (Permissible Exposure Limit), and the recommended guideline, the ACGIH TLV (Threshold Limit Value), for many compounds found in welding fume.

Ventilation

There are many methods which can be selected by the user to provide adequate ventilation for the specific application. The following section provides general information which may be helpful in evaluating what type of ventilation equipment may be suitable for your application. When ventilation equipment is installed, you should confirm worker exposure is controlled within applicable OSHA PEL and/or ACGIH TLV. According to OSHA regulations, when welding and cutting (mild steels), natural ventilation is usually considered sufficient to meet requirements, provided that:

1. **The room or welding area contains at least 10,000 cubic feet (about 22 in x 22 in x 22 in) for each welder.**
2. **The ceiling height is not less than 16 feet.**
3. **Cross ventilation is not blocked by partitions, equipment, or other structural barriers.**
4. **Welding is not done in a confined space.**

Spaces that do not meet these requirements should be equipped with mechanical ventilating equipment that exhausts at least 2000 CFM of air for each welder, except where local exhaust hoods or booths, or air-line respirators are used.



IMPORTANT SAFETY NOTE:

When welding with electrodes which require special ventilation such as stainless or hardfacing (see instructions on container or MSDS) or on lead or cadmium plated steel and other metals or coatings which produce hazardous fumes, keep exposure as low as possible and below exposure limit values (PEL and TLV) for materials in the fume using local exhaust or mechanical ventilation. In confined spaces or in some circumstances, for example outdoors, a respirator may be required if exposure cannot be controlled to the PEL or TLV. (See MSDS) Additional precautions are also required when welding on alvanized steel.

REFER TO [HTTP://WWW.LINCOLNELECTRIC.COM/SAFETY](http://www.lincolnelectric.com/safety) FOR ADDITIONAL SAFETY INFORMATION.



DON'T BE RESTRICTED BY DIFFUSIBLE HYDROGEN LIMITS! H4 CLASSIFIED FLUXES



