

Cruiser[®] and Tandem Cruiser[®] Tractors

Processes

Submerged Arc

Product Number

K3048-1 Cruiser[®] Tractor

K3083-1 Tandem Cruiser[®] Tractor

Input Power

40 VDC

Rated Output

1000A at 100% Duty Cycle

Travel Speed in/min (m/min)

10 - 100 (0.25 - 2.5)

Gearing

Standard: 142:1

Optional: 95:1, 57:1

Wire Feed Speed Range ipm (m/min)

142:1 - 15 - 200 (0.4 - 5.0)

95:1 - 15 - 300 (0.4 - 7.6)

57:1 - 50 - 500 (1.3 - 12.7)

Wire Dia. Range in. (mm) Solid

142:1 - 3/32 - 7/32 (2.4 - 5.6)

95:1 - 1/16 - 1/8 (1.6 - 3.2)

57:1 - 1/16 - 3/32 (1.6 - 2.4)

Weight / Dimensions

See Page 4 for details

Submerged Arc Welding Tractors

The self propelled, modular Cruiser[®] and Tandem Cruiser[®] travel carriages, used with the Power Wave[®] AC/DC 1000[®] SD power source, can deliver deposition rates up to 30 lbs. (13.61 kg) per arc, per hour for butt and fillet joints on lengthy plate welding applications common in bridge or barge decking, large tank fabrication or shipbuilding.

FEATURES

- ▶ **Reliable Operation** – Strong, rigid and stiff especially where you need it most.
 - Sturdy welded base frame.
 - Substantial steel mast stands up to daily construction site use.
 - Simple cast wheels – Equipped with high temperature and slip resistant rubber tires.
 - Robust tube and clamp design – Trouble-free feeding component mounting.
 - Adjustable extended length outriggers – Make it easy to guide tractor movement.
- ▶ **Advanced Control Pendant** – Removable, lightweight, impact resistant aluminum user interface can be used to save procedures, apply limits and lockouts for any or all controls.
- ▶ **Common Expendable Parts** – All drive rolls, nozzles, contact tips and wire straighteners are shared with the MAXsa[®] submerged arc wire drives.
- ▶ **Multiple Configurations** – Flexible system allows set-up with or without a track and three or four wheel operation. Tandem model not recommended for three wheel operation.

APPLICATIONS

- ▶ Bridge and Barge Decking
- ▶ Shipbuilding
- ▶ Offshore
- ▶ Large Tank Fabrication
- ▶ Heavy Manufacturing



Shown: K3048-1 Cruiser[®] Tractor

WHAT'S INCLUDED

- ▶ Conduit Tubing – 5 feet (1.5 m)
- ▶ 5/32 in. (4.0 mm) 600 Amp Contact Nozzle Assembly
- ▶ 5/32 in. (4.0 mm) Contact Tip
- ▶ Nozzle Extension – 5 in. (127 mm)
- ▶ Curved Nozzle Extension, 45°
- ▶ Nozzle Extension Insulator
- ▶ Flux Tubing
- ▶ Flux Hose Clamps
- ▶ Wire Reel Assembly
- ▶ Wheels for Track Operation
- ▶ Cross Slide Assembly (2 for Tandem)
- ▶ Front and Rear Outriggers
- ▶ Enclosed Wire Reel (2 for Tandem)
- ▶ K1733-5 Wire Straightener (2 for Tandem)

Note: Control cable not included

RECOMMENDED POWER SOURCE

- ▶ Power Wave[®] AC/DC 1000[®] SD

INPUT OUTPUT



Two Year Extended Warranty Available in the U.S.A. and Canada

IP23 Rated



CRUISER®

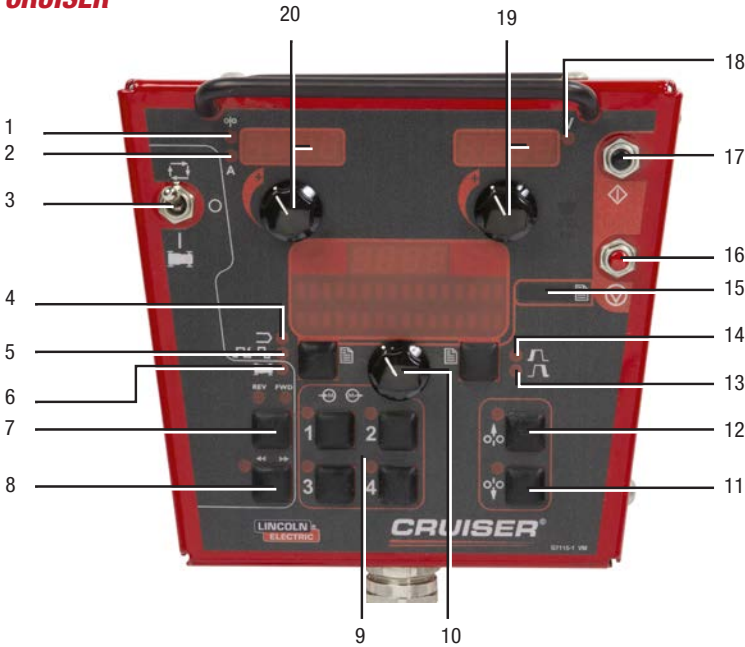

- | | |
|--|--------------------------------------|
| 1. WFS LED | 11. Inch Down |
| 2. AMPS LED | 12. Inch Up |
| 3. Auto / OFF / Manual Travel Switch | 13. Arc End Options (Right Button) |
| 4. Weld Mode Selection (Left Button) | 14. Arc Start Options (Right Button) |
| 5. Frequency and Balance (Left Button) | 15. Set-Up Menu |
| 6. Travel Menu (Left Button) | 16. Stop Pushbutton |
| 7. Travel Direction | 17. Start Pushbutton |
| 8. Jog | 18. Volts LED |
| 9. Memories | 19. Voltage Display and Control |
| 10. Mode Select Display and Control | 20. WFS/Amps Display and Control |

TANDEM CRUISER®

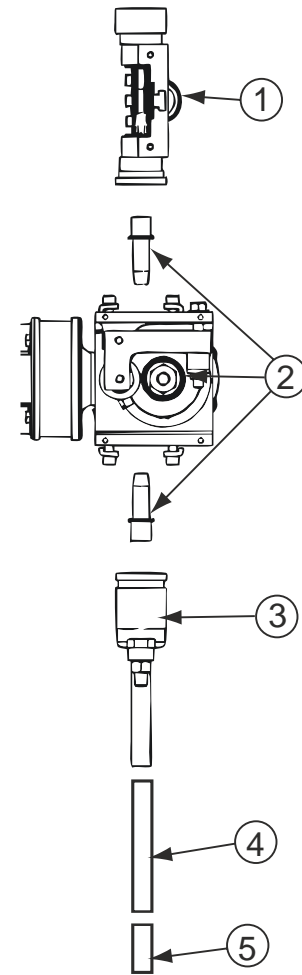
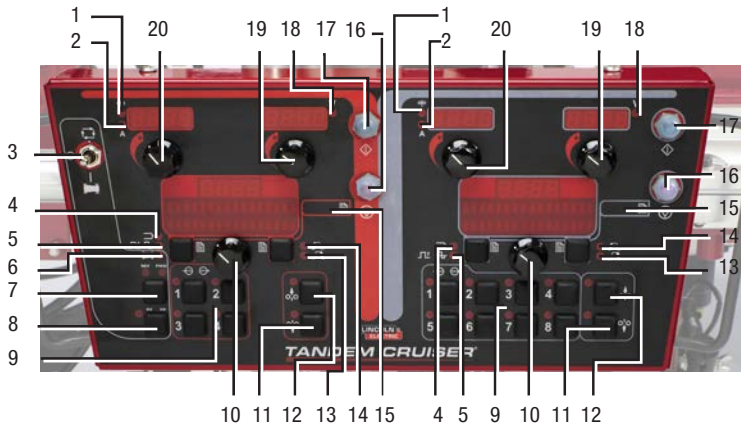

Item	Product Number	Description
1	K1733-5	Wire Straightener
2	KP1899-1 KP1899-2 KP1899-3 KP1899-4	Drive Roll/Guide Tube Kit - 3/32-7/32 in. Drive Roll/Guide Tube Kit - 1/16, 5/64, 3/32 in. Drive Roll/Guide Tube Kit - .035, .045, .052 in. Drive Roll/Guide Tube Kit - .045, .052 in. Cored
3	K231-1	Contact Nozzle Assembly - 5/64-3/16 in. (2.0-4.8 mm) - Rated up to 600 amps
4	KP2721-1 KP2721-2 T12929 T11807	Nozzle Extension - 5 in. Nozzle Extension - 45° Curved Flux Hose Clamp Nozzle Extension Insulator
5	KP1962-3B1 KP1962-1B1 KP1962-4B1 KP1962-2B1 KP1962-5B1 KP3162-3B1 KP3162-1B1 KP3162-4B1 KP3162-2B1 KP3162-5B1 K148A or K148B K285	Severe Duty Contact Tip - 3/32 in. (2.4 mm) Severe Duty Contact Tip - 1/8 in. (3.2 mm) Severe Duty Contact Tip - 5/32 in. (4.0 mm) Severe Duty Contact Tip - 3/16 in. (4.8 mm) Severe Duty Contact Tip - 7/32 in. (5.6 mm) Extended Life Contact Tips - 3/32 in. (2.4 mm) Extended Life Contact Tips - 1/8 in. (3.2 mm) Extended Life Contact Tips - 5/32 in. (4.0 mm) Extended Life Contact Tips - 3/16 in. (4.8 mm) Extended Life Contact Tips - 7/32 in. (5.6 mm) Positive Contact Nozzle Assembly - Rated up to 1000 amps Concentric Flux Cone Assembly to use with K148A or K148B



1



2



3



4

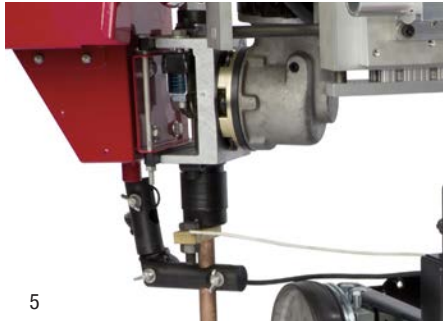

5



6

1. Improved Rigidity and Stiffness

- Base is fabricated from a single weldment.
- Designed to carry weight and maintain a steady track.

2. Heavy Duty Cross Slides

- Ceramic coated rails resist corrosion and wear.
- Minimal deflection results in accurate electrode placement in the joint.

3. New Rugged Wheels

- High temperature rubber wheels on cast aluminum core wheels – Rated to 500° F (260° C) continuous service.

4. Modified Mast and Boom Clamping System

- Grade 8 bolts resist stripping.
- Improved wrench clearance.

5. Proven Industrial Wire Drive

- Feeds up to 7/32 in. (5.6 mm) diameter wire.
- Change gear ratios to extend wire feed speed range.
- Rotate in two directions to set up virtually any torch angle.
- Rated for handling wire at up to 1000 amps at 100% duty cycle.

6. Cable Rack

- Extended rear rack provides positive strain relief for feeder cables.

7. Laser Pointer and Improved Steering

- Switch on and off to help locate joint during set up.
- Extended outriggers with additional adjustment and guide wheel provide smooth tracking in wider range of applications.

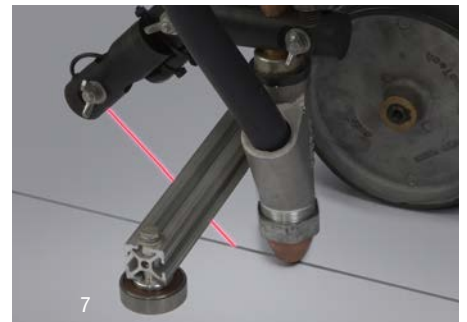

7

8. Tandem Cruiser®

- Carries two wire reels.
- Allows placement of two wires in one arc for greater deposition.



8

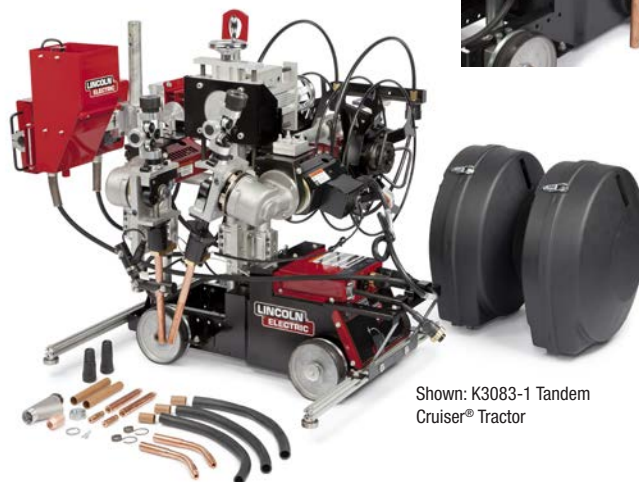

Shown: K3083-1 Tandem Cruiser® Tractor

REQUIRED OPTIONS

ArcLink® Control Cables

Available in two forms:

- K1543-xx series for most indoor or factory installations.
- K2683-xx series for outdoor use or when the equipment is frequently moved.

ARCLINK® CONTROL EXTENSION CABLES		
	Length	Order Number
		8 ft. (2.5 m) 16 ft. (4.8 m) 25 ft. (7.6 m) 50 ft. (15.2 m) 100 ft. (30.4 m)

ARCLINK® CONTROL EXTENSION CABLES		
	Length	Order Number
		25 ft. (7.6 m) 50 ft. (15.2 m) 100 ft. (30.5 m)

RECOMMENDED ACCESSORIES

GENERAL OPTIONS



Tube and Clamp Kit

One 30 in. (762 mm) aluminum splined tube; two 15 in. (381 mm) aluminum splined tubes; one 30 in. (762 mm) steel tube; 8 clamp assemblies with keys; 2 outrigger assemblies; hardware.
Order K3090-1



Track Section

Each section provides 70 in. (1.8 m) of travel.
Order K396



50-60 lb Coil Adapter

Adapts 50-60 lb. (22.6-27.2 kg) coil of Lincoln Electric electrode to 2 in. (51 mm) spindle.
Order K1504-1



Butt Joint Guide Kit (Tandem only)

Used to track the joint and guide the Tandem Cruiser® for plate and decking applications.
Order K3154-1



Cross Slide Assembly

Includes two slides with 4 in. (102 mm) of travel.
Order K3089-1



Nozzle Extension, 45°

Frequently used when making horizontal fillet welds.
Order KP2721-2



Wire Straightener

Includes a three roll wire straightener with adjustable pressure. For up to 7/32 in. (5.6 mm) diameter wire.
Order K1733-5



Tiny Twin Kit for Cruiser®

Includes a second spindle, drive rolls and 95:1 gears.
Order K3070-1

PRODUCT SPECIFICATIONS

Product Name	Product Number	Input Power	Rated Output Current/Duty Cycle	Travel Speed in/min (m/min)	Gearing	Wire Feed Speed Range ipm (m/min)	Wire Size Range in. (mm) Solid	Dimensions H x W x D in. (mm)	Net Weight lbs. (kg)
Cruiser® Tractor	K3048-1	40 VDC	1000A / 100%	10 - 100 (0.25 - 2.5)	142:1	15 - 200 (0.4 - 5.0)	3/32 - 7/32 (2.4 - 5.6)	29 x 23 x 36 (736 x 584 x 914)	207 (94)
					95:1 ⁽¹⁾	15 - 300 (0.4 - 7.6)	1/16 - 1/8 (1.6 - 3.2)		
Tandem Cruiser® Tractor	K3083-1				57:1 ⁽¹⁾	50 - 500 (1.3 - 12.7)	1/16 - 3/32 (1.6 - 2.4)	36.5 x 45.5 x 41.5 (927 x 1156 x 1054)	300 (136)

⁽¹⁾ Optional

CUSTOMER ASSISTANCE POLICY

The business of The Lincoln Electric Company is manufacturing and selling high quality welding equipment, consumables, and cutting equipment. Our challenge is to meet the needs of our customers and to exceed their expectations. On occasion, purchasers may ask Lincoln Electric for information or advice about their use of our products. Our employees respond to inquiries to the best of their ability based on information provided to them by the customers and the knowledge they may have concerning the application. Our employees, however, are not in a position to verify the information provided or to evaluate the engineering requirements for the particular weldment. Accordingly, Lincoln Electric does not warrant or guarantee or assume any liability with respect to such information or advice. Moreover, the provision of such information or advice does not create, expand, or alter any warranty on our products. Any express or implied warranty that might arise from the information or advice, including any implied warranty of merchantability or any warranty of fitness for any customers' particular purpose is specifically disclaimed.

Lincoln Electric is a responsive manufacturer, but the selection and use of specific products sold by Lincoln Electric is solely within the control of, and remains the sole responsibility of the customer. Many variables beyond the control of Lincoln Electric affect the results obtained in applying these types of fabrication methods and service requirements.

Subject to Change – This information is accurate to the best of our knowledge at the time of printing. Please refer to www.lincolnelectric.com for any updated information.