

Operator's Manual

Flextec[®] 500X

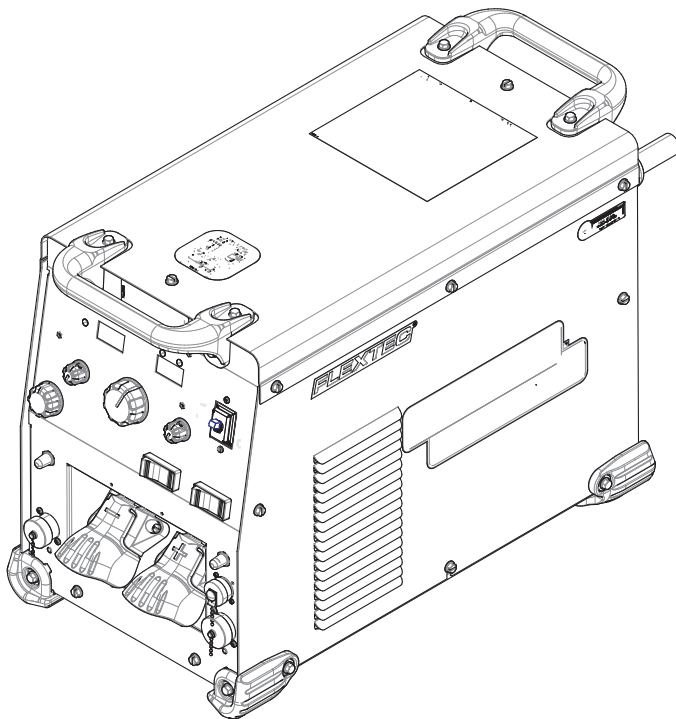

For use with machines having Code Numbers:

12806



Register your machine:

www.lincolnelectric.com/register

Authorized Service and Distributor Locator:

www.lincolnelectric.com/locator

Save for future reference

Date Purchased

Code: (ex: 10859)

Serial: (ex: U1060512345)

Need Help? Call 1.888.935.3877

to talk to a Service Representative

Hours of Operation:

8:00 AM to 6:00 PM (ET) Mon. thru Fri.

After hours?

Use "Ask the Experts" at lincolnelectric.com
A Lincoln Service Representative will contact you
no later than the following business day.

For Service outside the USA:

Email: globalservice@lincolnelectric.com

THANK YOU FOR SELECTING A QUALITY PRODUCT BY LINCOLN ELECTRIC.

PLEASE EXAMINE CARTON AND EQUIPMENT FOR DAMAGE IMMEDIATELY

When this equipment is shipped, title passes to the purchaser upon receipt by the carrier. Consequently, claims for material damaged in shipment must be made by the purchaser against the transportation company at the time the shipment is received.

SAFETY DEPENDS ON YOU

Lincoln arc welding and cutting equipment is designed and built with safety in mind. However, your overall safety can be increased by proper installation ... and thoughtful operation on your part. **DO NOT INSTALL, OPERATE OR REPAIR THIS EQUIPMENT WITHOUT READING THIS MANUAL AND THE SAFETY PRECAUTIONS CONTAINED THROUGHOUT.** And, most importantly, think before you act and be careful.

WARNING

This statement appears where the information must be followed exactly to avoid serious personal injury or loss of life.

CAUTION

This statement appears where the information must be followed to avoid minor personal injury or damage to this equipment.



KEEP YOUR HEAD OUT OF THE FUMES.

DON'T get too close to the arc. Use corrective lenses if necessary to stay a reasonable distance away from the arc.

READ and obey the Safety Data Sheet (SDS) and the warning label that appears on all containers of welding materials.

USE ENOUGH VENTILATION or exhaust at the arc, or both, to keep the fumes and gases from your breathing zone and the general area.

IN A LARGE ROOM OR OUTDOORS, natural ventilation may be adequate if you keep your head out of the fumes (See below).

USE NATURAL DRAFTS or fans to keep the fumes away from your face.

If you develop unusual symptoms, see your supervisor. Perhaps the welding atmosphere and ventilation system should be checked.

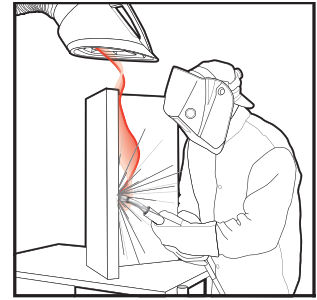

WEAR CORRECT EYE, EAR & BODY PROTECTION

PROTECT your eyes and face with welding helmet properly fitted and with proper grade of filter plate (See ANSI Z49.1).

PROTECT your body from welding spatter and arc flash with protective clothing including woolen clothing, flame-proof apron and gloves, leather leggings, and high boots.

PROTECT others from splatter, flash, and glare with protective screens or barriers.

IN SOME AREAS, protection from noise may be appropriate.

BE SURE protective equipment is in good condition.

Also, wear safety glasses in work area **AT ALL TIMES.**



SPECIAL SITUATIONS

DO NOT WELD OR CUT containers or materials which previously had been in contact with hazardous substances unless they are properly cleaned. This is extremely dangerous.

DO NOT WELD OR CUT painted or plated parts unless special precautions with ventilation have been taken. They can release highly toxic fumes or gases.

Additional precautionary measures

PROTECT compressed gas cylinders from excessive heat, mechanical shocks, and arcs; fasten cylinders so they cannot fall.

BE SURE cylinders are never grounded or part of an electrical circuit.

REMOVE all potential fire hazards from welding area.

ALWAYS HAVE FIRE FIGHTING EQUIPMENT READY FOR IMMEDIATE USE AND KNOW HOW TO USE IT.



SECTION A: WARNINGS



CALIFORNIA PROPOSITION 65 WARNINGS



WARNING: Breathing diesel engine exhaust exposes you to chemicals known to the State of California to cause cancer and birth defects, or other reproductive harm.

- Always start and operate the engine in a well-ventilated area.
- If in an exposed area, vent the exhaust to the outside.
- Do not modify or tamper with the exhaust system.
- Do not idle the engine except as necessary.

For more information go to www.P65warnings.ca.gov/diesel

WARNING: This product, when used for welding or cutting, produces fumes or gases which contain chemicals known to the State of California to cause birth defects and, in some cases, cancer. (California Health & Safety Code § 25249.5 *et seq.*)



WARNING: Cancer and Reproductive Harm
www.P65warnings.ca.gov

ARC WELDING CAN BE HAZARDOUS. PROTECT YOURSELF AND OTHERS FROM POSSIBLE SERIOUS INJURY OR DEATH. KEEP CHILDREN AWAY. PACEMAKER WEARERS SHOULD CONSULT WITH THEIR DOCTOR BEFORE OPERATING.

Read and understand the following safety highlights. For additional safety information, it is strongly recommended that you purchase a copy of "Safety in Welding & Cutting - ANSI Standard Z49.1" from the American Welding Society, P.O. Box 351040, Miami, Florida 33135 or CSA Standard W117.2. A Free copy of "Arc Welding Safety" booklet E205 is available from the Lincoln Electric Company, 22801 St. Clair Avenue, Cleveland, Ohio 44117-1199.

BE SURE THAT ALL INSTALLATION, OPERATION, MAINTENANCE AND REPAIR PROCEDURES ARE PERFORMED ONLY BY QUALIFIED INDIVIDUALS.



FOR ENGINE POWERED EQUIPMENT.

- Turn the engine off before troubleshooting and maintenance work unless the maintenance work requires it to be running.
- Operate engines in open, well-ventilated areas or vent the engine exhaust fumes outdoors.
- Do not add the fuel near an open flame welding arc or when the engine is running. Stop the engine and allow it to cool before refueling to prevent spilled fuel from vaporizing on contact



with hot engine parts and igniting. Do not spill fuel when filling tank. If fuel is spilled, wipe it up and do not start engine until fumes have been eliminated.

- Keep all equipment safety guards, covers and devices in position and in good repair. Keep hands, hair, clothing and tools away from V-belts, gears, fans and all other moving parts when starting, operating or repairing equipment.
- In some cases it may be necessary to remove safety guards to perform required maintenance. Remove guards only when necessary and replace them when the maintenance requiring their removal is complete. Always use the greatest care when working near moving parts.
- Do not put your hands near the engine fan. Do not attempt to override the governor or idler by pushing on the throttle control rods while the engine is running.
- To prevent accidentally starting gasoline engines while turning the engine or welding generator during maintenance work, disconnect the spark plug wires, distributor cap or magneto wire as appropriate.
- To avoid scalding, do not remove the radiator pressure cap when the engine is hot.
- Using a generator indoors CAN KILL YOU IN MINUTES.
- Generator exhaust contains carbon monoxide. This is a poison you cannot see or smell.
- NEVER use inside a home or garage, EVEN IF doors and windows are open.
- Only use OUTSIDE and far away from windows, doors and vents.
- Avoid other generator hazards. READ MANUAL BEFORE USE.



ELECTRIC AND MAGNETIC FIELDS MAY BE DANGEROUS



- Electric current flowing through any conductor causes localized Electric and Magnetic Fields (EMF). Welding current creates EMF fields around welding cables and welding machines
- EMF fields may interfere with some pacemakers, and welders having a pacemaker should consult their physician before welding.
- Exposure to EMF fields in welding may have other health effects which are now not known.
- All welders should use the following procedures in order to minimize exposure to EMF fields from the welding circuit:
 - Route the electrode and work cables together - Secure them with tape when possible.
 - Never coil the electrode lead around your body.
 - Do not place your body between the electrode and work cables. If the electrode cable is on your right side, the work cable should also be on your right side.
 - Connect the work cable to the workpiece as close as possible to the area being welded.
 - Do not work next to welding power source.



ELECTRIC SHOCK CAN KILL.



- 3.a. The electrode and work (or ground) circuits are electrically “hot” when the welder is on. Do not touch these “hot” parts with your bare skin or wet clothing. Wear dry, hole-free gloves to insulate hands.
- 3.b. Insulate yourself from work and ground using dry insulation. Make certain the insulation is large enough to cover your full area of physical contact with work and ground.

In addition to the normal safety precautions, if welding must be performed under electrically hazardous conditions (in damp locations or while wearing wet clothing; on metal structures such as floors, gratings or scaffolds; when in cramped positions such as sitting, kneeling or lying, if there is a high risk of unavoidable or accidental contact with the workpiece or ground) use the following equipment:

- Semiautomatic DC Constant Voltage (Wire) Welder.
 - DC Manual (Stick) Welder.
 - AC Welder with Reduced Voltage Control.
- 3.c. In semiautomatic or automatic wire welding, the electrode, electrode reel, welding head, nozzle or semiautomatic welding gun are also electrically “hot”.
 - 3.d. Always be sure the work cable makes a good electrical connection with the metal being welded. The connection should be as close as possible to the area being welded.
 - 3.e. Ground the work or metal to be welded to a good electrical (earth) ground.
 - 3.f. Maintain the electrode holder, work clamp, welding cable and welding machine in good, safe operating condition. Replace damaged insulation.
 - 3.g. Never dip the electrode in water for cooling.
 - 3.h. Never simultaneously touch electrically “hot” parts of electrode holders connected to two welders because voltage between the two can be the total of the open circuit voltage of both welders.
 - 3.i. When working above floor level, use a safety belt to protect yourself from a fall should you get a shock.
 - 3.j. Also see Items 6.c. and 8.



ARC RAYS CAN BURN.



- 4.a. Use a shield with the proper filter and cover plates to protect your eyes from sparks and the rays of the arc when welding or observing open arc welding. Headshield and filter lens should conform to ANSI Z87.1 standards.
- 4.b. Use suitable clothing made from durable flame-resistant material to protect your skin and that of your helpers from the arc rays.
- 4.c. Protect other nearby personnel with suitable, non-flammable screening and/or warn them not to watch the arc nor expose themselves to the arc rays or to hot spatter or metal.



FUMES AND GASES CAN BE DANGEROUS.



- 5.a. Welding may produce fumes and gases hazardous to health. Avoid breathing these fumes and gases. When welding, keep your head out of the fume. Use enough ventilation and/or exhaust at the arc to keep fumes and gases away from the breathing zone. **When welding hardfacing (see instructions on container or SDS) or on lead or cadmium plated steel and other metals or coatings which produce highly toxic fumes, keep exposure as low as possible and within applicable OSHA PEL and ACGIH TLV limits using local exhaust or mechanical ventilation unless exposure assessments indicate otherwise. In confined spaces or in some circumstances, outdoors, a respirator may also be required. Additional precautions are also required when welding on galvanized steel.**
- 5.b. The operation of welding fume control equipment is affected by various factors including proper use and positioning of the equipment, maintenance of the equipment and the specific welding procedure and application involved. Worker exposure level should be checked upon installation and periodically thereafter to be certain it is within applicable OSHA PEL and ACGIH TLV limits.
- 5.c. Do not weld in locations near chlorinated hydrocarbon vapors coming from degreasing, cleaning or spraying operations. The heat and rays of the arc can react with solvent vapors to form phosgene, a highly toxic gas, and other irritating products.
- 5.d. Shielding gases used for arc welding can displace air and cause injury or death. Always use enough ventilation, especially in confined areas, to insure breathing air is safe.
- 5.e. Read and understand the manufacturer’s instructions for this equipment and the consumables to be used, including the Safety Data Sheet (SDS) and follow your employer’s safety practices. SDS forms are available from your welding distributor or from the manufacturer.
- 5.f. Also see item 1.b.



WELDING AND CUTTING SPARKS CAN CAUSE FIRE OR EXPLOSION.

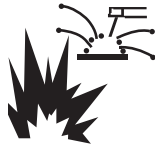

- 6.a. Remove fire hazards from the welding area. If this is not possible, cover them to prevent the welding sparks from starting a fire. Remember that welding sparks and hot materials from welding can easily go through small cracks and openings to adjacent areas. Avoid welding near hydraulic lines. Have a fire extinguisher readily available.
- 6.b. Where compressed gases are to be used at the job site, special precautions should be used to prevent hazardous situations. Refer to "Safety in Welding and Cutting" (ANSI Standard Z49.1) and the operating information for the equipment being used.
- 6.c. When not welding, make certain no part of the electrode circuit is touching the work or ground. Accidental contact can cause overheating and create a fire hazard.
- 6.d. Do not heat, cut or weld tanks, drums or containers until the proper steps have been taken to insure that such procedures will not cause flammable or toxic vapors from substances inside. They can cause an explosion even though they have been "cleaned". For information, purchase "Recommended Safe Practices for the Preparation for Welding and Cutting of Containers and Piping That Have Held Hazardous Substances", AWS F4.1 from the American Welding Society (see address above).
- 6.e. Vent hollow castings or containers before heating, cutting or welding. They may explode.
- 6.f. Sparks and spatter are thrown from the welding arc. Wear oil free protective garments such as leather gloves, heavy shirt, cuffless trousers, high shoes and a cap over your hair. Wear ear plugs when welding out of position or in confined places. Always wear safety glasses with side shields when in a welding area.
- 6.g. Connect the work cable to the work as close to the welding area as practical. Work cables connected to the building framework or other locations away from the welding area increase the possibility of the welding current passing through lifting chains, crane cables or other alternate circuits. This can create fire hazards or overheat lifting chains or cables until they fail.
- 6.h. Also see item 1.c.
- 6.i. Read and follow NFPA 51B "Standard for Fire Prevention During Welding, Cutting and Other Hot Work", available from NFPA, 1 Batterymarch Park, PO box 9101, Quincy, MA 022690-9101.
- 6.j. Do not use a welding power source for pipe thawing.



CYLINDER MAY EXPLODE IF DAMAGED.

- 7.a. Use only compressed gas cylinders containing the correct shielding gas for the process used and properly operating regulators designed for the gas and pressure used. All hoses, fittings, etc. should be suitable for the application and maintained in good condition. 
- 7.b. Always keep cylinders in an upright position securely chained to an undercarriage or fixed support.
- 7.c. Cylinders should be located:
 - Away from areas where they may be struck or subjected to physical damage.
 - A safe distance from arc welding or cutting operations and any other source of heat, sparks, or flame.
- 7.d. Never allow the electrode, electrode holder or any other electrically "hot" parts to touch a cylinder.
- 7.e. Keep your head and face away from the cylinder valve outlet when opening the cylinder valve.
- 7.f. Valve protection caps should always be in place and hand tight except when the cylinder is in use or connected for use.
- 7.g. Read and follow the instructions on compressed gas cylinders, associated equipment, and CGA publication P-1, "Precautions for Safe Handling of Compressed Gases in Cylinders," available from the Compressed Gas Association, 14501 George Carter Way Chantilly, VA 20151.



FOR ELECTRICALLY POWERED EQUIPMENT.



- 8.a. Turn off input power using the disconnect switch at the fuse box before working on the equipment.
- 8.b. Install equipment in accordance with the U.S. National Electrical Code, all local codes and the manufacturer's recommendations.
- 8.c. Ground the equipment in accordance with the U.S. National Electrical Code and the manufacturer's recommendations.

Refer to
<http://www.lincolnelectric.com/safety>
for additional safety information.

ECO design information

The equipment has been designed in order to be compliant with the Directive 2009/125/EC and the Regulation 2019/1784/EU.

Efficiency and idle power consumption:

Name	Efficiency when max power consumption / Idle power consumption	Equivalent model
Flextec 500x CE Construction with K3129 filter	89.5% / 75 W	Flextec 500x CE/RCM with K3129 filter

idle state, set the Weld Terminals to off and Local/Remote to remote and wait until the fan is off. The fan will be off when the units are powered up, or will turn off after a delay of (up to) 5 minutes if the welding output was just disabled.

The value of efficiency and consumption in idle state have been measured by method and conditions defined in the product standard EN 60974-1

Manufacturer's name, product name, code number, product number, serial number and date of production can be read from rating plate and serial number label.

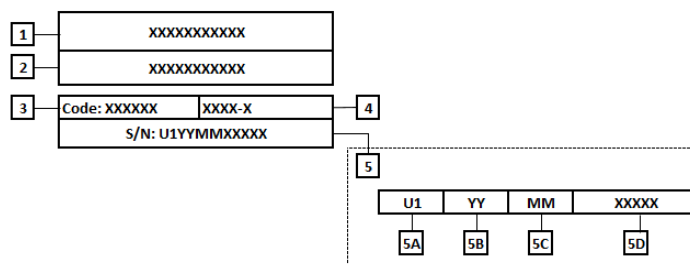

Where:

- | | |
|----------------------------------|---|
| 1- Manufacturer name and address | 5- Serial number |
| 2- Product name | 5A- country of production |
| 3- Code number | 5B- year of production |
| 4- Product number | 5C- month of production |
| | 5D- progressive number different for each machine |

Typical gas usage for **MIG/MAG** equipment:

Material type	Wire diameter [mm]	DC electrode positive		Wire Feeding [m/min]	Shielding Gas	Gas flow [l/min]
		Current [A]	Voltage [V]			
Carbon, low alloy steel	0,9 - 1,1	95 - 200	18 - 22	3,5 – 6,5	Ar 75%, CO ₂ 25%	12
Aluminum	0,8 - 1,6	90 - 240	18 - 26	5,5 – 9,5	Argon	14 - 19
Austenitic stainless steel	0,8 - 1,6	85 - 300	21 - 28	3 - 7	Ar 98%, O ₂ 2% / He 90%, Ar 7,5% CO ₂ 2,5%	14 - 16
Copper alloy	0,9 - 1,6	175 - 385	23 - 26	6 - 11	Argon	12 - 16
Magnesium	1,6 - 2,4	70 - 335	16 - 26	4 - 15	Argon	24 - 28

Tig Process:

In TIG welding process, gas usage depends on cross-sectional area of the nozzle. For comonly used torches:

Helium: 14-24 l/min

Argon: 7-16 l/min

Notice: Excessive flow rates causes turbulence in the gas stream which may aspirate atmospheric contamination into the welding pool.

Notice: A cross wind or draft moving can disrupt the shielding gas coverage, in the interest of saving of protective gas use screen to block air flow.



End of life

At end of life of product, it has to be disposal for recycling in accordance with Directive 2012/19/EU (WEEE), information about the dismantling of product and Critical Raw Material (CRM) present in the product, can be found at:

www.lincolnelectriceurope.com

Flextec 500X CE
Flextec 500X + K3129-2

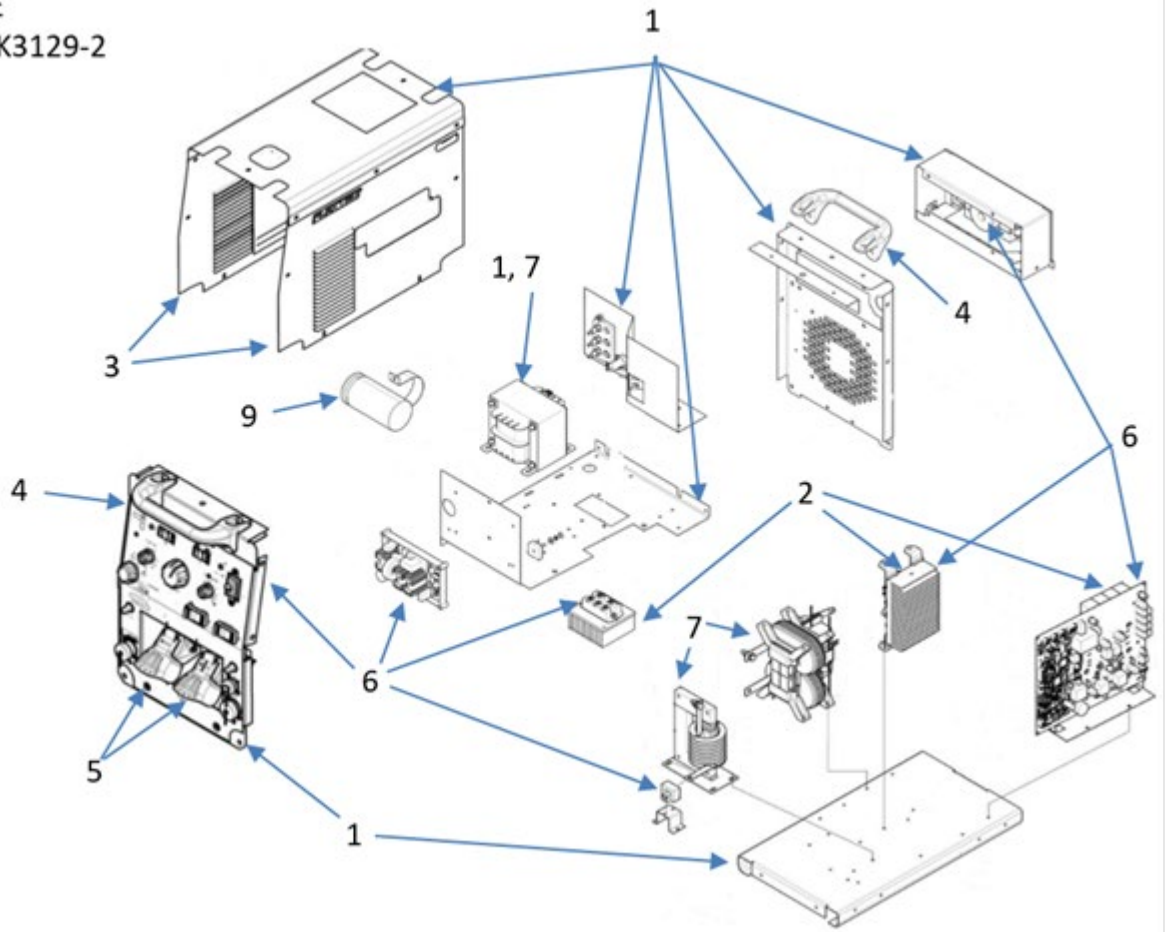

Item	Component	Material for recovery	CRM	Selective treatment
1	Enclosure	Steel	-	-
2	Heat sink	Aluminum	Si, 20 g Mg, 34 g	-
3	Enclosure	Aluminum	Si, 9 g Mg, 181 g	-
4	Handle	Aluminum	Si, 118 g Mg, 1 g	-
5	Output terminal	Brass	-	-
6	PC board	-	-	Required
7	Choke Transformers Internal cables	Copper	-	-
8	External cables – not shown	Copper	-	Required
9	Capacitor	-	-	Required

Reference: P-1325-A, code 12807
P-1285-A, code 12806

AGENCY APPROVALS.....3
 PRODUCT DESCRIPTION.....3
 DESIGN FEATURES.....3

INSTALLATIONSECTION A
 TECHNICAL SPECIFICATIONSA-1
 RECOMMENDED PROCESSESA-2
 PROCESS LIMITATIONS.....A-2
 EQUIPMENT LIMITATIONS.....A-2
 COMMON EQUIPMENT PACKAGESA-2
 COMMON OPTIONAL KITS & ACCESSORIES.....A-3
 COMPATIBLE WIRE FEEDERS – ANALOG & ARCLINK FEEDERSA-3
 BASIC MODES OF OPERATIONA-4
 INPUT AND GROUND CONNECTIONSA-7
 INPUT FUSE AND SUPPLY WIRE CONSIDERATIONS.....A-7
 INPUT VOLTAGE SELECTIONA-8
 LOCATIONA-8
 LIFTINGA-8
 STACKINGA-8
 ENVIRONMENTAL LIMITATIONSA-8
 HIGH FREQUENCY PROTECTIONA-8
 VRD™ (VOLTAGE REDUCTION DEVICE)A-8
 CONNECTION DIAGRAMS, CONTROL CABLES.....A-9
 RECOMMENDED ELECTRODE AND WORK CABLE SIZES FOR ARC WELDINGA-11
 CONTROL CABLE AND VOLTAGE SENSING CONNECTIONS.....A-12

OPERATIONSECTION B
 POWER-UP SEQUENCEB-1
 GRAPHIC SYMBOLS THAT APPEAR ON THIS MACHINE OR IN THIS MANUALB-2
 CASE FRONT CONTROLSB-3
 CASE BACK CONTROLSB-4
 INTERNAL CONTROLS.....B-5
 DUTY CYCLEB-6
 COMMON WELDING PROCEDURESB-6
 DEFINITION OF WELDING MODESB-6
 WELD CONTROLS AND DISPLAYSB-6

GENERAL OPTIONS.....SECTION C
 FUME EXTRACTING SYSTEMS.....C-1
 STICK OPTIONSC-1
 TIG OPTIONSC-1

MAINTENANCESECTION D
 ROUTINE MAINTENANCE.....D-1
 PERIODIC MAINTENANCE.....D-1

TROUBLESHOOTING.....SECTION E

DIAGRAMSSECTION F

WIRING DIAGRAMSSECTION G

PARTS LISTPARTS.LINCOLNELECTRIC.COM

CONTENT/DETAILS MAY BE CHANGED OR UPDATED WITHOUT NOTICE. FOR MOST CURRENT INSTRUCTION MANUALS, GO TO PARTS.LINCOLNELECTRIC.COM.

AGENCY APPROVALS

MODEL	MARKET	CONFORMITY MARK	NOTES
K3607-1	US AND CANADA	CSA _{CUS}	
	AUSTRALIA	C-TICK / RCM	REQUIRES K3129-2
	EUROPE	CE	CE FILTER KIT

PRODUCT DESCRIPTION

The Flextec® 500X is a multi-process CC/CV DC inverter power source rated for 450 Amps, 38 Volts at 100% duty cycle. The Flextec® 500X comes in a rugged case and is intended for either indoor or outdoor operation and comes with an IP23 environmental rating. Transporting the Flextec® 500X is made simple through lifting handles. The user interface of the Flextec® 500X is simple and intuitive. Weld modes are selected via a 5 position selector switch. Volts and Amps are displayed on an easy to view LED display, and the amps and volts are set via a large output control knob. A hot start and an arc control knob allow for finer tuning of the welding arc for the application. The Flextec® 500X is designed for the North America and Export markets and operates on 380V, 460V, or 575V 50hz or 60hz three phase power. Switching between voltages is made simple via a reconnect panel located on the case back.

The Flextec® 500X is designed to be compatible with the current range of semi-automatic digital wire feeders (such as the Power Feed feeders) in addition to analog and across-the-arc wire feeders. The Flextec® 500X comes with a 5-pin amphenol, a 12-pin amphenol, and a 14-pin amphenol standard. Voltage sensing is either done at the studs or via a 67 lead when operating with an ArcLink wire feeder.

The Flextec® 500X machine is factory pre-programmed with multiple welding procedures, typically including GMAW, GMAW-P, FCAW, SMAW, CAG, and GTAW for a variety of materials, including mild steel, stainless steel and aluminum. The Flextec® 500X comes standard with the 4 basic process modes which are accessible via the machine case front controls. The ArcLink mode position and ArcLink feeders unlock synergic and pulse mig mode capabilities.

All models of the Flextec® 500X come with CrossLinc™ Technology for remote output setting with CrossLinc™ compatible feeders or remote controls.

DESIGN FEATURES

- **The Future is Now** – You no longer have to pay a price premium to gain the advantages of inverter technology over conventional welders.
 - Faster arc response means smoother arc action and more consistent bead appearance
 - Low power consumption results in daily operational cost savings
 - Enhanced portability – typically 50% less weight, size and footprint
- **Simple and Easy to Use**
- **Flexible Multi-Process Capability** – Including stick, TIG, MIG, Flux-cored and CAG.
- **Bright Digital Amp and Volt Meters** – Easy to monitor, even in sunlight, and presettable for precise procedure control, display error codes for troubleshooting
- **Compact, Durable Case** – Tough IP23 enclosure rating ensures the ability to withstand extreme field environments.
- **Variable Hot Start** – Get the extra starting amperage you need for thick, rusty or dirty material.
- **Variable Arc Control** – In stick mode, vary the arc force to obtain the “soft” or “crisp” arc you want as conditions require. In CV modes vary the pinch or inductance to control spatter, fluidity and bead appearance.
- **Procedure Control** – Utilize Feeder capabilities such as user memories, preference options, and procedure lockouts
- **Full-Featured Remote Control Capability** – Use a foot pedal or hand control to remotely vary output up to 100 ft. (30.5 mm) away. Master / Slave functionality for precise arc control.
- **380 – 575 VAC, 50/60Hz Voltage Input** – Offers the ability to be connected anywhere in the world.
- **Voltage Compensation and Reliable Input Voltage Connection** – Provides consistent operation over ±10% input voltage variation.
- **Easy to Parallel Machines or Run Multiple Arcs in CC mode.**
- **Severe Duty** – Can be stored outdoors. IP23 Rated.
- **Desert Duty Rated** – Welding outputs are rated for extreme temperature operation up to 55° C
- **ArcLink® Wire Feeder Compatible** – unlock synergic modes to increase productivity and control
- **Synergic Modes** – for easy, repeatable welds
- **VRD** – reduces OCV when not welding for added safety.
- **Low Operating Cost** – Operates at a high efficiency
- **Transport** - Reversible handles for ease of lifting.

INSTALLATION

TECHNICAL SPECIFICATIONS

POWER SOURCES - INPUT VOLTAGE AND CURRENT					
MODEL	DUTY CYCLE	INPUT VOLTAGE ± 10%	INPUT AMPERES	IDLE POWER (W)	POWER FACTOR
K3607-1	60% RATING	380 / 460 / 575 / 3 / 50 / 60	39 / 32 / 32	150W FAN ON	91%
	100% RATING		33 / 27 / 27	70W FAN OFF	

POWER SOURCES - RECOMMENDED INPUT WIRE AND FUSE SIZES ¹					
VOLTAGE	INPUT AMPERES (100% RATING)	TIME DELAY FUSE OR BREAKER SIZE	TYPE 75C COPPER WIRE IN CONDUIT AWG (IEC) SIZES 40C (104°F) AMBIENT	TYPE 75C COPPER GROUND WIRE IN CONDUIT AWG (IEC) SIZES	CORD SIZE AWG SIZES
380/3/50	33 A	60	8 (10)	10 (6)	8
460/3/60	27 A	50	10 (6)	10 (6)	8
575/3/60	27 A	50	10 (6)	10 (6)	8

RATED OUTPUT				
PROCESS	DUTY CYCLE	VOLTS AT RATED AMPERES	AMPERES	EFFICIENCY (AT RATED OUTPUT)
GMAW (CV)	60%	39 V	500A	89%
	100%	36.5 V	450A	
GTAW (CC)	60%	30 V	500A	
	100%	28 V	450A	
SMAW (CC)	60%	40 V	500A	
	100%	38 V	450A	
FCAW-GS (CV)	60%	39 V	500A	
	100%	36.5 V	450A	
FCAW-SS (CV)	60%	39 V	500A	
	100%	36.5 V	450A	

PHYSICAL DIMENSIONS				
MODEL	HEIGHT	WIDTH	DEPTH	WEIGHT
K3607-1	18.8 IN (477 MM)	14 IN (356 MM)	26.5 IN (673 MM)	120 LBS. (54.43 KG)

TEMPERATURE RANGES	
OPERATING TEMPERATURE	14° F TO 131° F (-10° C TO 55° C)*
STORAGE TEMPERATURE	-40° F TO 185° F (-40° C TO 85° C)
INSULATION CLASS	CLASS H (180° C)

*Output is derated for temperatures in excess of 40° C (104° F).

RECOMMENDED PROCESSES

The Flextec® 500X is designed for CC-SMAW, CC-GTAW (Touch Start tig), CV-GMAW, CV-GMAW-P, CV-FCAW-SS and CV-FCAW-GS welding processes. CAG arc gouging is also supported.

WELD MODE	PROCESS	COMMON MATERIALS	COMMON ELECTRODES
GTAW	LIFT TIG (CC)	STAINLESS, STEEL	
SMAW	STICK-CC	STAINLESS, STEEL	6010, 6011, 7018
CV	MIG (GMAW) FCAW-GS	ALUMINUM, STAINLESS, STEEL	L-50; L-56 ULTRACORE®
CV-INNERSHIELD	FCAW-SS	ALUMINUM, STAINLESS, STEEL	NR-203; NR-211, NR-440NI2
ARCLINC	SYNERGIC GMAW GMAW-P	ALUMINUM, STAINLESS, STEEL	L-50; L-56 METAL CORE

PROCESS LIMITATIONS

The Flextec® 500X is suitable only for the processes listed.

EQUIPMENT LIMITATIONS

OUTPUT RATINGS AT 40° C			
AMPS	DUTY CYCLE	VOLTS	TEMPERATURE
450	100%	38V	40° C
500	60%	40V	
OUTPUT RATINGS AT 55° C ELEVATED TEMPERATURES			
AMPS	DUTY CYCLE	VOLTS	TEMPERATURE
375	100%	35V	55° C
400	60%	36V	

Operating Temperature Range is -10° C to + 55° C.

Output is de-rated for temperatures in excess of 40° C.

COMMON EQUIPMENT PACKAGES

FLEX FEED 84 READY-PAK	
K3607-1	FLEXTEC® 500X
K3056-2	LOCKING FOOT KIT
K5000-2	FLEX FEED 84 BENCH MODEL
K2952-2-10-45	MAGNUM® PRO CURVE 400
K1842-10	3/0 WELDING CABLE KIT
K2149-1	WORK LEAD PACKAGE
3100211	HARRIS FLOWMETER
K3059-2	UNDERCARRIAGE

LF-72 READY-PAK	
K3607-1	FLEXTEC® 500X
K3056-2	LOCKING FOOT KIT
K2327-7	LF-74 BENCH MODEL
K2952-2-10-45	MAGNUM® PRO CURVE 400
K1842-10	3/0 WELDING CABLE KIT
K2149-1	WORK LEAD PACKAGE
3100211	HARRIS FLOWMETER
K3059-2	UNDERCARRIAGE

LF-74 READY-PAK	
K3607-1	FLEXTEC® 500X
K3056-2	LOCKING FOOT KIT
K2426-5	LF-74 BENCH MODEL
K2952-2-10-45	MAGNUM® PRO CURVE 400
K1842-10	3/0 WELDING CABLE KIT
K2149-1	WORK LEAD PACKAGE
3100211	HARRIS FLOWMETER
K3059-2	UNDERCARRIAGE

POWER FEED 84 READY-PAK	
K3607-1	FLEXTEC® 500X
K3056-2	LOCKING FOOT KIT
K3328-13	POWER FEED 84 BENCH MODEL
K2952-2-10-45	MAGNUM® PRO CURVE 400
K1842-10	3/0 WELDING CABLE KIT
K2149-1	WORK LEAD PACKAGE
3100211	HARRIS FLOWMETER
K3059-4	UNDERCARRIAGE

COMMON OPTIONAL KITS & ACCESSORIES

K4345-1	CROSSLINC REMOTE
K3059-4	INVERTER CART
K3056-2	LOCKING FOOT KIT - FLEXTEC® 500X
K3091-1	MULTI-PROCESS SWITCH
K2909-1	12-PIN TO 6-PIN ADAPTER
K4217-1	WIRELESS FOOT PEDAL
K857-2	REMOTE OUTPUT CONTROL WITH 12-PIN UNIVERSAL CONNECTOR (25 FEET)
K857-3	REMOTE OUTPUT CONTROL WITH 12-PIN UNIVERSAL CONNECTOR (100 FEET)
K870-2	FOOT AMPTROL, 12-PIN, 25 FT
K963-3	HAND AMPTROL, 12-PIN, 25FT
K3129-2	FLEXTEC® CE FILTER KIT (380-575 VAC)

COMPATIBLE WIRE FEEDERS – ANALOG & ARCLINK FEEDERS

NORTH AMERICAN SEMI-AUTOMATIC WIRE FEEDERS	
PF10M, PF25M, PF84	POWER FEED SERIES (40VDC INPUT)
LF-72, LF-74	LF SERIES (42VAC INPUT)
ALL MODELS	FLEX FEED SERIES (42VAC INPUT)
ALL MODELS	LN-10, DH-10 (42VAC INPUT)
ALL MODELS	LN-25 PRO SERIES, ACTIV8, LN-25X, ACTIV8X, LN-23P
EUROPEAN SEMI-AUTOMATIC WIRE FEEDERS	
PF-44, PF-46	POWER FEED SERIES (EXCLUDING PF42 & PF 40 FOR FLUX CORED)
LF-33S, LF-33, LF-34, LF-35, LF-37, LF-38, LN-15	LINC FEED SERIES (42VAC INPUTS ONLY)
LF-45, LF-45S	LINC FEED SERIES (40VDC INPUTS)
LF-22M, LF-24M, LF-24 PRO	LINC FEED SERIES (ACROSS THE ARC INPUT)

BASIC MODES OF OPERATION

SMAW

This weld mode is a constant current (CC) mode featuring continuous control from 15 – 500 Amps.

It is intended for the SMAW stick welding processes and arc gouging. The mode can also be used for TIG operation without changing modes.

Hot Start - The Hot Start control regulates the starting current at arc initiation. Hot Start can be set to "0" and no additional current is added at arc start. Increasing from 0 to 10 will increase the additional current (relative to the preset current) that is added at arc initiation.

Arc Control - The Arc Control regulates the Arc Force to adjust the short circuit current. The minimum setting (-10) will produce a "soft" arc and will produce minimal spatter and shallow penetration. The maximum setting (+10) will produce a "crisp" arc and will minimize electrode sticking with deeper penetration.

Weld Terminals On/Remote – Set to "On" so the machine is in the ready to weld state. Setting the machine to "On" enables the machine OCV.

Voltage LCD Display – This display will display three dashed lines when the machine is in the idle state. This indicates that voltage is not settable in this weld mode. While output is enabled, the actual welding voltage will be displayed. After welding, the meter holds the actual voltage value for 5 seconds. Output adjustment while in the "hold" period results in the "prior to operation" characteristics stated above. The displays blink indicating that the machine is in the "Hold" period.

Amperage LCD Display – This display will display the pre-set welding current when the machine is in the idle state. After welding, the meter holds the actual amperage value for 5 seconds. Output adjustment while in the "hold" period results in the "prior to operation" characteristics stated above. The displays blink indicating that the machine is in the "Hold" period.

Output Control Local/Remote – When the control is set to local (no remote potentiometer/control plugged into the 12-pin or 14-pin connectors), the output is controlled through the Output Control dial on the front of the Flextec® 500X. Set this switch to 'Remote' when an external potentiometer/control is connected.

- When a remote potentiometer is connected, the output control on the Flextec® and the remote act as a master/slave configuration. Use the output control dial on the Flextec® to set the maximum welding current. The remote will control output from minimum to the pre-set maximum.

Output Control Dial

- When the Local/Remote is set to Local, this dial sets the welding amperage.
- When the Local/Remote is set to Remote, this dial sets the maximum welding amperage. The remote potentiometer than controls the amperage from minimum to this pre-set maximum.

GTAW

This weld mode is a constant current (CC) mode featuring continuous control from 10 –500 amps.

It is intended for the GTAW TIG welding processes.

Hot Start - Hot start regulates the arc initiation current. A setting of +10 results in the most positive arc initiation.

Arc Control – This control is not used in the GTAW mode.

Weld Terminals On/Remote

- When set to the 'ON' position, the weld terminals are at OCV (open circuit voltage) and ready to weld.
- When set to the 'remote' position, output is enabled through a remote trigger.

Voltage LCD Display – This display will display three dashed lines when the machine is in the idle state. This indicates that voltage is not settable in this weld mode. While output is enabled, the actual welding voltage will be displayed. After welding, the meter holds the actual voltage value for 5 seconds. Output adjustment while in the "hold" period results in the "prior to operation" characteristics stated above. The displays blink indicating that the machine is in the "Hold" period.

Amperage LCD Display – This display will display the pre-set welding current when the machine is in the idle state. After welding, the meter holds the actual amperage value for 5 seconds. Output adjustment while in the "hold" period results in the "prior to operation" characteristics stated above. The displays blink indicating that the machine is in the "Hold" period.

Output Control Local/Remote – When the control is set to local (no remote potentiometer/control plugged into the 12-pin or 14-pin connectors), the output is controlled through the Output Control dial on the front of the Flextec® 500X. Set this switch to 'Remote' when an external potentiometer/control is connected.

- When a remote potentiometer is connected, the output control on the Flextec® and the remote act as a master/slave configuration. Use the output control dial on the Flextec® to set the maximum welding current. The remote will control output from minimum to the pre-set maximum.

Output Control Dial

- When the Local/Remote is set to Local, this dial sets the welding amperage.
- When the Local/Remote is set to Remote, this dial sets the maximum welding amperage. The remote potentiometer than controls the amperage from minimum to this pre-set maximum.

CV-Gas

This weld mode is a constant voltage (CV) mode featuring continuous control from 10 to 45 volts.

It is intended for the GMAW, FCAW-GS, MCAW welding processes and arc gouging.

Hot Start – Rotate from the '0' position to the '10' position to provide more energy during the start of a weld.

Arc Control – The Arc Control regulates pinch effect. At the minimum setting (-10), minimizes pinch and results in a soft arc. Low pinch settings are preferable for welding with gas mixes containing mostly inert gases as well as aluminum alloys. At the maximum setting (+10), maximizes pinch effect and results in a crisp arc. High pinch settings are preferable for welding FCAW and GMAW with CO₂.

Weld Terminals On/Remote

- When set to the 'ON' position, the weld terminals are at OCV (open circuit voltage) and ready to weld. This selection is used for across the arc wire feeders. The 12-pin connector remote input is used to adjust the voltage with a master/slave relationship with the output control dial.
- When set to the 'remote' position, output is enabled through a remote trigger. The 14-pin connector remote input is used to adjust the voltage with a master/slave relationship with the output control dial.

Amperage LCD Display – This display will display three dashed lines when the machine is in the idle state. This indicates that amperage is not settable in this weld mode. While output is enabled, the actual welding amperage will be displayed. After welding, the meter holds the actual amperage value for 5 seconds. Output adjustment while in the "hold" period results in the "prior to operation" characteristics stated above. The displays blink indicating that the machine is in the "Hold" period.

Voltage LCD Display – This display will display the pre-set welding voltage when the machine is in the idle state. After welding, the meter holds the actual voltage value for 5 seconds. Output adjustment while in the "hold" period results in the "prior to operation" characteristics stated above. The displays blink indicating that the machine is in the "Hold" period.

Output Control Local/Remote – When the control is set to local (no remote potentiometer/control plugged into the 12-pin or 14-pin connectors), the output is controlled through the Output Control dial on the front of the Flextec® 500X. Set this switch to 'Remote' when an external potentiometer/control is connected.

Output Control Dial

- When the Local/Remote is set to Local, this dial sets the welding voltage.
- When the Local/Remote is set to Remote, and the weld terminal switch is in the 'ON' position, this dial sets the maximum welding voltage. The remote potentiometer controls the voltage from minimum to this pre-set maximum. If the weld terminal switch is in the 'REMOTE' position, the output is controlled via the 14-pin input.

CV-Innershield

This weld mode is a constant voltage (CV) mode featuring continuous control from 10 to 45 volts.

It is intended for the FCAW-SS welding process and arc gouging.

Hot Start – Toggle from the '0' position to the '10' position to provide more energy during the start of a weld.

Arc Control – The Arc Control regulates pinch effect. At the minimum setting (-10), minimizes pinch and results in a soft arc. At the maximum setting (+10), maximizes pinch effect and results in a crisp arc.

Weld Terminals On/Remote

- When set to the 'ON' position, the weld terminals are at OCV (open circuit voltage) and ready to weld. This selection is used for across the arc wire feeders. The 12-pin connector remote input is used to adjust the voltage with a master/slave relationship with the output control dial.
- When set to the 'remote' position, output is enabled through a remote trigger. The 14-pin connector remote input is used to adjust the voltage with a master/slave relationship with the output control dial.

Amperage LCD Display – This display will display three dashed lines when the machine is in the idle state. This indicates that amperage is not settable in this weld mode. While output is enabled, the actual welding amperage will be displayed. After welding, the meter holds the actual amperage value for 5 seconds. Output adjustment while in the "hold" period results in the "prior to operation" characteristics stated above. The displays blink indicating that the machine is in the "Hold" period.

Voltage LCD Display – This display will display the pre-set welding voltage when the machine is in the idle state. After welding, the meter holds the actual voltage value for 5 seconds. Output adjustment while in the "hold" period results in the "prior to operation" characteristics stated above. The displays blink indicating that the machine is in the "Hold" period.

Output Control Local/Remote – When the control is set to local (no remote potentiometer/control plugged into the 12-pin or 14-pin connectors), the output is controlled through the Output Control dial on the front of the Flextec® 500X. Set this switch to 'Remote' when an external potentiometer/control is connected.

Output Control Dial

- When the Local/Remote is set to Local, this dial sets the welding voltage.
- When the Local/Remote is set to Remote, and the weld terminal switch is in the 'ON' position, this dial sets the maximum welding voltage. The remote potentiometer controls the voltage from minimum to this pre-set maximum. If the weld terminal switch is in the 'REMOTE' position, the output is controlled via the 14-pin input.

ArcLink

This weld mode is intended to unlock basic GMAW pulse and synergic modes intended for use with a compatible ArcLink wire feeders. All of the Flextec® 500X user interface controls are disabled in this mode and controlling the power source is accomplished from the wire feeder user interface.

Hot Start – Not used for this welding process

Arc Control – Not used for this welding process

Weld Terminals On/Remote

- Not used for this welding process

Amperage LCD Display – This display will display three dashed lines when the machine is in the idle state. This indicates that amperage is not settable in this weld mode. While output is enabled, the actual welding amperage will be displayed. After welding, the meter holds the actual amperage value for 5 seconds. Output adjustment while in the "hold" period results in the "prior to operation" characteristics stated above. The displays blink indicating that the machine is in the "Hold" period.

Voltage LCD Display – This display will display three dashed lines when the machine is in the idle state. After welding, the meter holds the actual voltage value for 5 seconds. Output adjustment while in the "hold" period results in the "prior to operation" characteristics stated above. The displays blink indicating that the machine is in the "Hold" period.

Output Control Local/Remote – Not used for this welding process

Output Control Dial

- Not used for this welding process

CrossLinc®

CrossLinc is a new welding system communication technology. When using a CrossLinc-enabled power source such as the Flextec® 500X and a CrossLinc enabled accessory such as the LN-25X or CrossLinc Remote, welding voltage can be controlled remotely without the use of an additional control cable.

The digital meters on the wire feeder will show the pre-set values for wire feed speed and voltage prior to welding. During welding, the meters will show actual current and voltage present at the wire feeder. After welding the meters will then flash the last welding current and voltage that was present during welding for 10-seconds after welding. If WFS or voltage is adjusted during this 10 second period, the meters will go back to the pre-set value.

The digital meters on the Flextec® 500X display will show dashes ("—") when connected to a CrossLinc-enabled accessory. While welding, the power source will display actual current and voltage.

- When a CrossLinc-enabled feeder is connected to the Flextec® 500X using the standard weld power cable and the accessory sense lead is attached to the work piece, the CrossLinc light will automatically illuminate on both the Flextec® 500X and the CrossLinc-enabled accessory. No additional pairing of the machine to the accessory is needed. This light indicates the CrossLinc connection is active and that control of the Flextec® 500X voltage can be made at the CrossLinc feeder.
- The Flextec® 500X 'WELD TERMINALS ON/REMOTE' toggle should be set to 'ON'. This powers the weld terminals for an across-the-arc wire feeder like an LN-25X.
- The Flextec® 500X Output Control 'LOCAL/REMOTE' toggle switch is ignored once a CrossLinc peripheral is detected by the power source, and welding output is controlled remotely by the CrossLinc accessory.

⚠ WARNING

ELECTRIC SHOCK CAN KILL.

Only qualified personnel should perform this installation.



- Turn off input power to the power source at the disconnect switch or fuse box before working on this equipment. Turn off the input power to any other equipment connected to the welding system at the disconnect switch or fuse box before working on the equipment.
- Do not touch electrically hot parts.
- Always connect the flextec grounding lug (located inside the reconnect input access door) to a proper safety (earth) ground.
- Only a qualified electrician should connect the input leads to the machine. Connections should be made in accordance with all local and national electrical codes and the connection diagram located underneath the case top of the machine. Failure to do so may result in bodily injury or death.

**INPUT AND GROUND CONNECTIONS
MACHINE GROUNDING**

The frame of the welder must be grounded. A ground terminal marked with the symbol shown is located inside the reconnect/input connection area for this purpose. See your local and national electrical codes for proper grounding methods.



INPUT FUSE AND SUPPLY WIRE CONSIDERATIONS

Refer to **Page A-1** for recommended fuse, wire sizes and type of the copper wires. Fuse the input circuit with the recommended super lag fuse or delay type breakers (also called "inverse time" or "thermal/magnetic" circuit breakers). Choose input and grounding wire size according to local or national electrical codes. Using input wire sizes, fuses or circuit breakers smaller than recommended may result in "nuisance" shut-offs from welder inrush currents, even if the machine is not being used at high currents.

Figure B.1

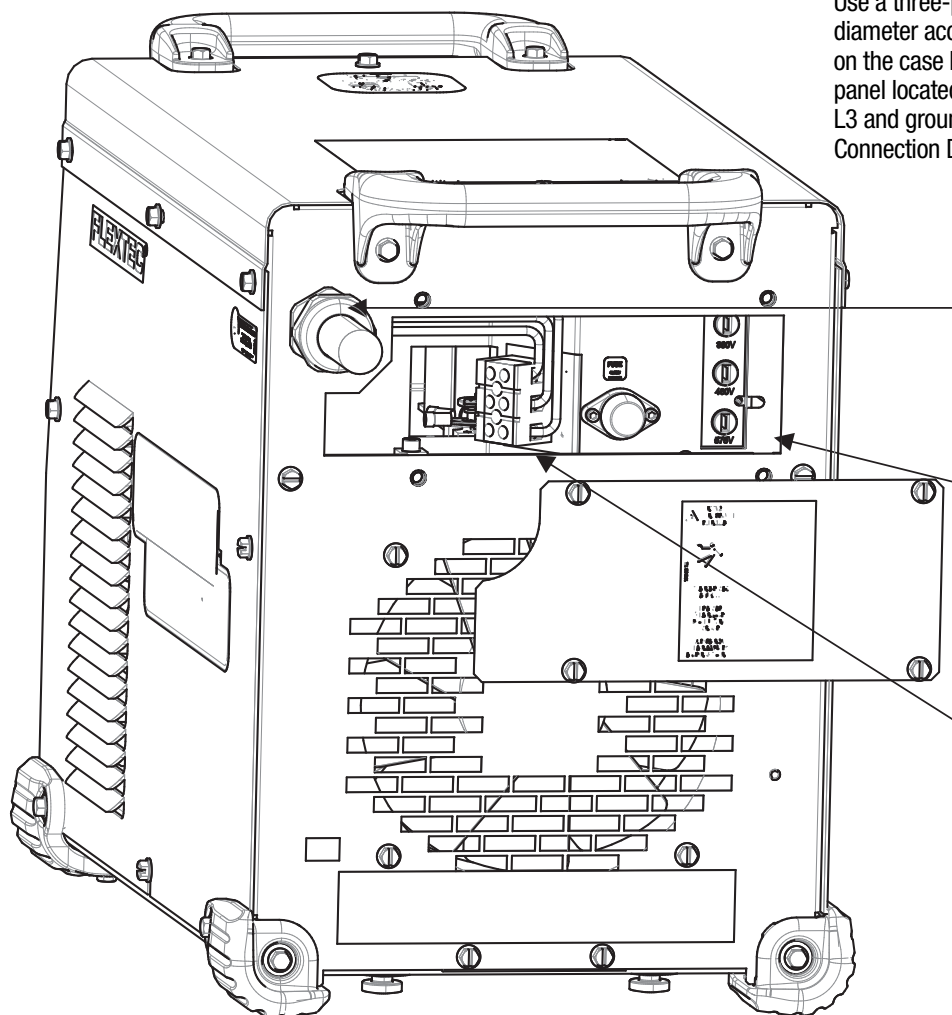

Use a three-phase supply line. A 1.40 inch (36 mm) diameter access hole for the input supply is located on the case back. Remove the reconnect access panel located on the case back and connect L1, L2, L3 and ground according to the Input Supply Connection Diagram decal. (See Figure B.1)

<p>Power Supply Access Hole</p> <ul style="list-style-type: none"> • Route input power cable through this hole. • Strain relief required. See your local and national electrical codes for proper strain relief.
<p>Reconnect Terminal Block</p> <p>Reconnects auxiliary transformer for the proper input voltages</p>
<p>Power Supply Terminal Block</p> <ul style="list-style-type: none"> • Line Cord/Cable attaches here. • A ground terminal marked with the symbol shown is provided separate from this block for connecting the ground lead of the line cord. See your local and national electrical codes for proper grounding methods.

INPUT VOLTAGE SELECTION

Welders are shipped connected for 460V input voltage. If the Auxiliary lead (indicated as 'A') is placed in the wrong position and power is applied to the machine, the machine will protect itself and display an error message:

- "Err" "713" or "714" will be shown on the display.
- The User Interface board and Switch Boards will blink out error 713 or 714 on their status LEDs.
- The weld output will be turned off and the control board will force itself into an idle state. The FAN will run continuously.
- The machine will need to have the misconnect condition removed before it will recover.

LOCATION

Location and ventilation for cooling

Place the welder where clean cooling air can freely circulate in through the rear louvers and out through the case sides and front. Dirt, dust, or any foreign material that can be drawn into the welder should be kept at a minimum. Failure to observe these precautions can result in excessive operating temperatures and nuisance shutdowns.

LIFTING

The Flextec® 500X has two handles that can be used to lift the machine.

Both handles should be used when lifting the machine. When using a crane or overhead device to lift using the handles, a lifting strap should be connected to both handles. Do not attempt to lift the Flextec® 500X with accessories attached to it.

STACKING

The Flextec® 500X cannot be stacked.

ENVIRONMENTAL LIMITATIONS

The Flextec® 500X is IP23 rated for use in an outdoor environment. The machine should not be subjected to falling water during use nor should any parts of it be submerged in water. Doing so may cause improper operation as well as pose a safety hazard. The best practice is to keep the machine in a dry, sheltered area.

Do not mount the Flextec® 500X over combustible surfaces. Where there is a combustible surface directly under stationary or fixed electrical equipment, that surface shall be covered with a steel plate at least .060" (1.6mm) thick, which shall extend not less than 5.90" (150mm) beyond the equipment on all sides.

HIGH FREQUENCY PROTECTION

Locate the Flextec® 500X away from radio controlled machinery. The normal operation of the machine may adversely affect the operation of RF controlled equipment, which may result in bodily injury or damage to the equipment.

VRD™ (VOLTAGE REDUCTION DEVICE)

The VRD™ feature provides additional safety in the CC-Stick mode. The VRD™ reduces the OCV (Open Circuit Voltage) at the welding output terminals while not welding to less than 35VDC peak.

The VRD™ requires that the welding cable connections be kept in good electrical condition because poor connections will contribute to poor starting. Having good electrical connections also limits the possibility of other safety issues such as heat-generated damage, burns and fires.

The machine is shipped with VRD™ "Disabled". The VRD™ function can be disabled or enabled via dip switches on the user interface P.C. board.

The user interface board and dip switches can be accessed by removing the case top and side as shown in Internal Controls section.

CONNECTION DIAGRAMS, CONTROL CABLES

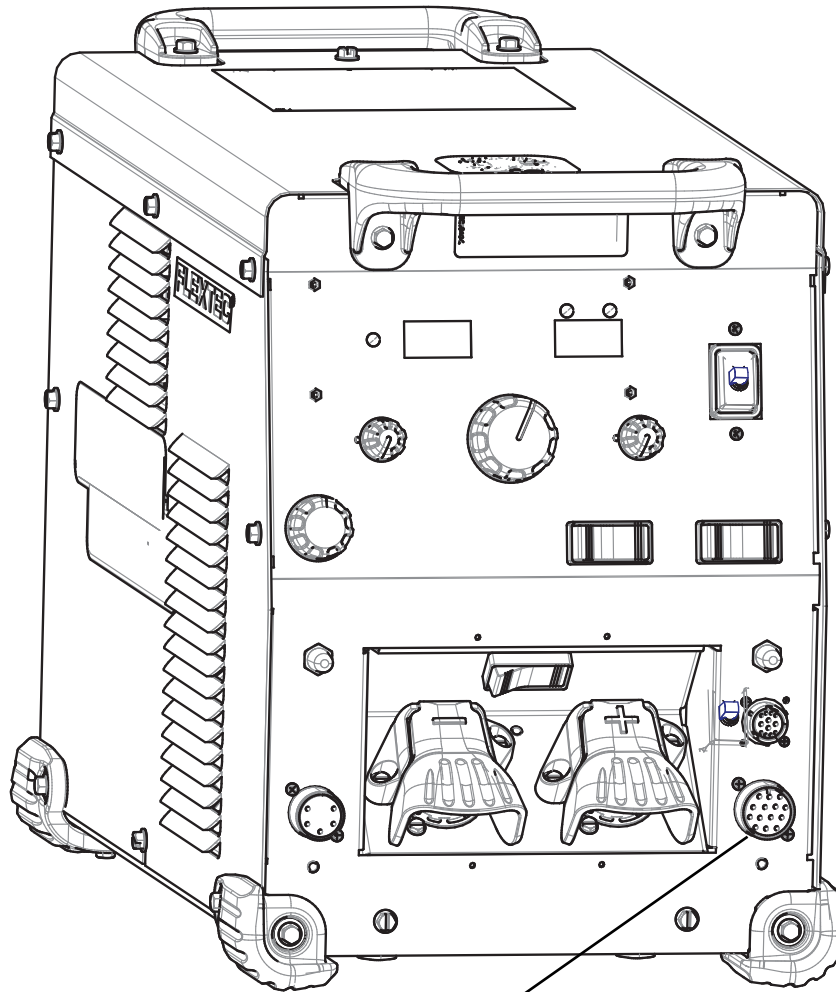

Analog Wire Feeder Connectivity

Picture	Function	Pin	Wiring
	14-pin connector for wire feeder connectivity.	A	
		B	Ground
		C	Trigger, Common
		D	Trigger input
		E	77 Remote potentiometer, 10V
		F	76 Remote potentiometer, wiper
		G	75 Remote potentiometer, common
		H	Work (21)
		I	42 VAC
		J	
		K	42 VAC
		L	
		M	
		N	

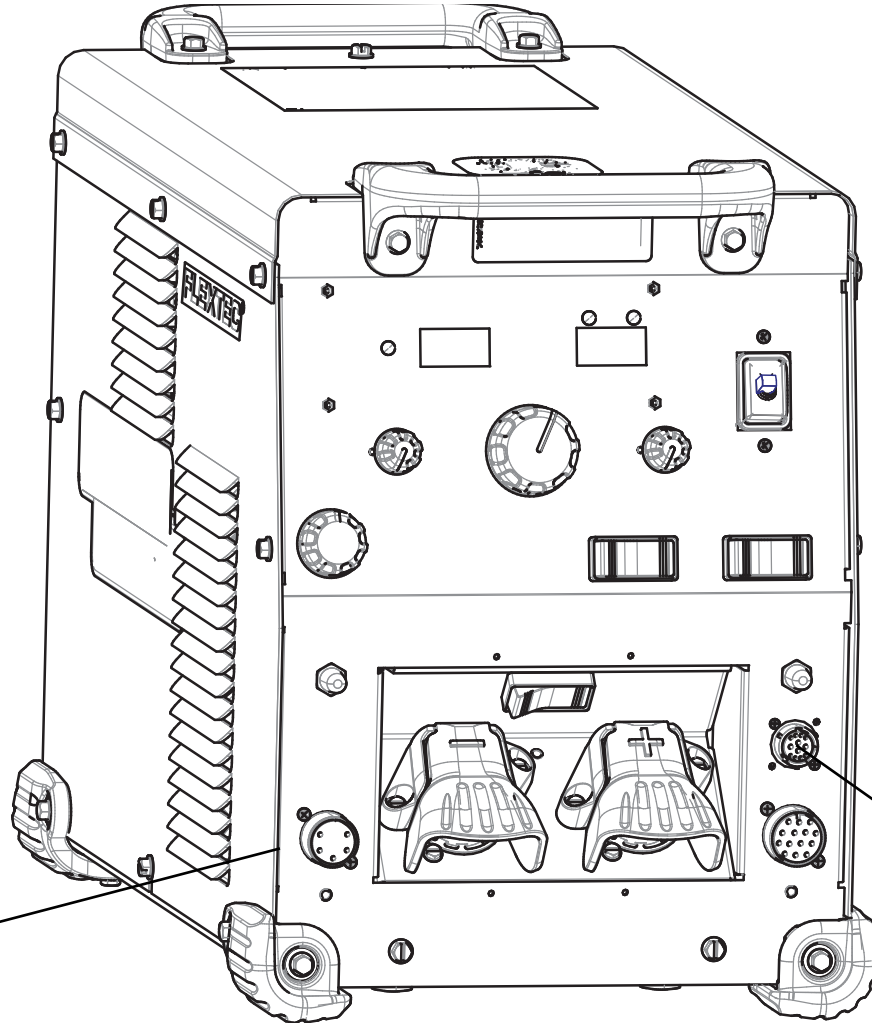

ArcLink Wire Feeder & Digital Accessory Connectivity

Picture	Function	Pin	Wiring
	5-pin connector for wire feeder connectivity.	A	ArcLink CAN
		B	ArcLink CAN
		C	Electrode Sense Lead
		D	40Vdc
		E	40Vdc Common
Picture	Function	Pin	Wiring
	12-pin remote control connector for remote or hand/foot amptrol and digital accessories.	A	ArcLink CAN
		B	ArcLink CAN
		C	Remote Potentiometer Common
		D	Remote Potentiometer Wiper
		E	Remote Potentiometer +10V
		F	ALPS connection
		G	Trigger
		H	Trigger
		J	40Vdc Common
		K	40Vdc
		L	Not Used
M	Not Used		

RECOMMENDED ELECTRODE AND WORK CABLE SIZES FOR ARC WELDING

General Guidelines

Connect the electrode and work cables between the appropriate output studs of the Flextec® 500X per the following guidelines:

- Most welding applications run with the electrode being positive (+). For those applications, connect the electrode cable between the wire drive feed plate and the positive (+) output stud on the power source. Connect a work lead from the negative (-) power source output stud to the work piece.
- When negative electrode polarity is required, such as in some Innershield applications, reverse the output connections at the power source (electrode cable to the negative (-) stud, and work cable to the positive (+) stud).

The following recommendations apply to all output polarities and weld modes:

- **Select the appropriate size cables per the “Output Cable Guidelines” below.** Excessive voltage drops caused by undersized welding cables and poor connections often result in unsatisfactory welding performance. Always use the largest welding cables (electrode and work) that are practical, and be sure all connections are clean and tight.

Note: Excessive heat in the weld circuit indicates undersized cables and/or bad connections.

- **Route all cables directly to the work and wire feeder, avoid excessive lengths and do not coil excess cable.** Route the electrode and work cables in close proximity to one another to minimize the loop area and therefore the inductance of the weld circuit.

- **Always weld in a direction away from the work (ground) connection.**

OUTPUT CABLE GUIDELINES

AMPERES	PERCENT DUTY CYCLE	CABLE SIZES FOR COMBINED LENGTHS OF ELECTRODE AND WORK CABLES [RUBBER COVERED COPPER - RATED 167°F (75°C)]**				
		0 TO 50 FT	50 TO 100 FT	100 - 150 FT	150 - 200 FT	200 - 250 FT
		200	60	2	2	2
200	100	2	2	2	1	1/0
250	30	3	3	2	1	1/0
250	40	2	2	1	1	1/0
250	60	1	1	1	1	1/0
250	100	1	1	1	1	1/0
300	60	1	1	1	1/0	2/0
300	100	2/0	2/0	2/0	2/0	3/0
350	40	1/0	1/0	2/0	2/0	3/0
400	60	2/0	2/0	2/0	3/0	4/0
400	100	3/0	3/0	3/0	3/0	4/0
500	60	2/0	2/0	3/0	3/0	4/0

CONTROL CABLE AND VOLTAGE SENSING CONNECTIONS

General Guidelines

Genuine Lincoln control cables should be used at all times (except where noted otherwise). Lincoln cables are specifically designed for the communication and power needs of the Flextec® 500X. Most are designed to be connected end-to-end for ease of extension. Generally, it is recommended that the total length not exceed 100 feet (30.5 m). The use of non-standard cables, especially in lengths greater than 25 feet, can lead to communication problems (system shutdowns), poor motor acceleration (poor arc starting), and low wire driving force (wire feeding problems). Always use the shortest length of control cable possible, and DO NOT coil excess cable.

Regarding cable placement, best results will be obtained when control cables are routed separate from the weld cables. This minimizes the possibility of interference between the high currents flowing through the weld cables, and the low level signals in the control cables.

Voltage Sensing Overview

The best arc performance occurs when the Flextec® 500X has accurate data about the arc conditions. Depending upon the process, inductance within the electrode and work cables can influence the voltage apparent at the studs of the welder, and have a dramatic effect on performance. A remote electrode voltage sense lead is used to improve the accuracy of the arc voltage information supplied to the machine. The electrode sense lead is integral to the ArcLink control cable.

General Guidelines for Voltage Sense Leads

Sense leads should be attached as close to the weld as practical, and out of the weld current path when possible. In extremely sensitive applications it may be necessary to route cables that contain the sense leads away from the electrode and work welding cables.

Electrode Voltage Sensing

The remote ELECTRODE sense lead (67) is built into the 5-pin ArcLink control cable (K1543-xx) and is always connected to the wire drive feed plate when a wire feeder is present.

Negative Electrode Polarity

Negative polarity semi-automatic process operation, in the ArcLink mode, requires the Meter Polarity Switch located on the case front, above the output studs, to be set to electrode negative for proper operation.

PROCESS	ELECTRODE VOLTAGE SENSING ¹	WORK VOLTAGE SENSING ²
GMAW	67 LEAD	VOLTAGE SENSE AT STUDS
FCAW	67 LEAD	VOLTAGE SENSE AT STUDS
GTAW	VOLTAGE SENSE AT STUDS	VOLTAGE SENSE AT STUDS
SMAW	VOLTAGE SENSE AT STUDS	VOLTAGE SENSE AT STUDS

1. The electrode voltage sense lead (67) is automatically enabled by the weld process, and integral to the 5-pin ArcLink control cable.
2. **Negative polarity semi-automatic process operation requires the Meter Polarity Switch on the case front to be set to electrode negative for proper operation.**

Paralleling Machines

The Flextec® 500X power sources may be paralleled for increased output requirements. No kit is required for paralleling of Flextec® 500X power sources. The Flextec® 500X can only be paralleled for constant current processes. Connect the power sources as shown on **Figure B2**, and set the output control of each power source to one half of the desired arc current.

Figure B.2

PARALLEL MACHINES SETUP WITH FLEXTEC 500X

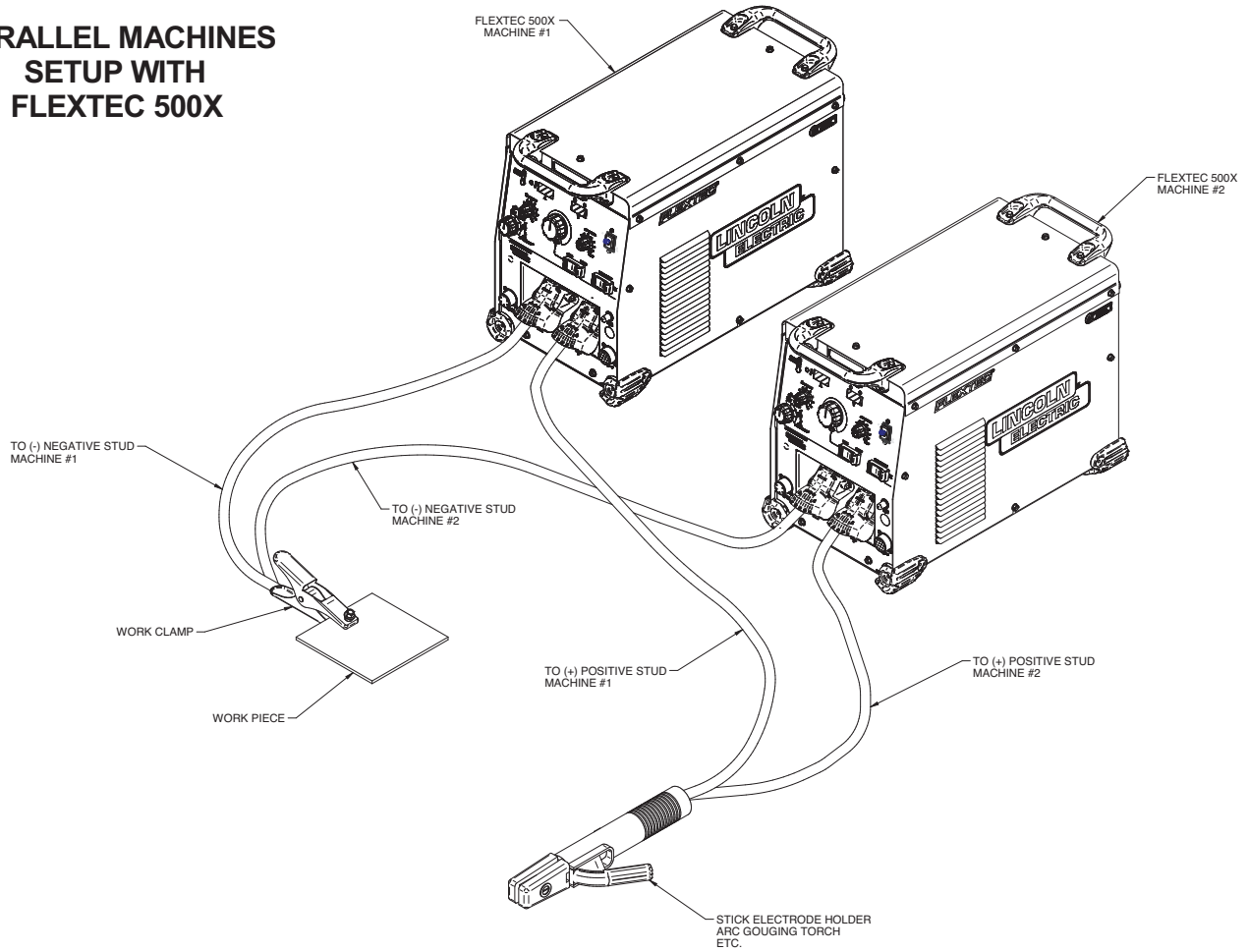

See connection diagrams in Diagrams section.

OPERATION

SAFETY PRECAUTIONS

Read this entire section of operating instructions before operating the machine.

WARNING

ELECTRIC SHOCK can kill.

- Unless using cold feed feature, when feeding with gun trigger, the electrode and drive mechanism are always electrically energized and could remain energized several seconds after the welding ceases.
- Do not touch electrically live parts or electrodes with your skin or wet clothing.
- Insulate yourself from the work and ground.
- Always wear dry insulating gloves.



FUMES AND GASES can be dangerous.

- Keep your head out of fumes.
- Use ventilation or exhaust to remove fumes from breathing zone.



WELDING SPARKS can cause fire or explosion.

- Keep flammable material away.
- Do not weld on containers that have held combustibles.



ARC RAYS can burn.

- Wear eye, ear, and body protection.



















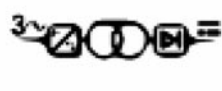

Observe additional guidelines detailed in the beginning of this manual.

POWER-UP SEQUENCE

When power is applied to the Flextec® 500X, the displays will illuminate and the machine electronics will complete a power up sequence indicated by a scrolling bar across each seven segment display. Once the power up sequence is complete and the machine is ready for welding, the seven segment displays will indicate the voltage and amperage settings. Any ArcLink wire feeders present and connected to the 5-pin circular connector will also initialize and begin a power up sequence once power is applied to the machine.

GRAPHIC SYMBOLS THAT APPEAR ON THIS MACHINE OR IN THIS MANUAL

	INPUT POWER	U_r	RATED REDUCED NO-LOAD VOLTAGE
	ON	U_0	OPEN CIRCUIT VOLTAGE
	OFF	U_1	INPUT VOLTAGE
	HIGH TEMPERATURE	U_2	OUTPUT VOLTAGE
	MACHINE STATUS	I_1	INPUT CURRENT
	CIRCUIT BREAKER	I_2	OUTPUT CURRENT
	WIRE FEEDER		PROTECTIVE GROUND
	POSITIVE OUTPUT		WARNING OR CAUTION
	NEGATIVE OUTPUT		EXPLOSION
	3 PHASE INVERTER		DANGEROUS VOLTAGE
	INPUT POWER		SHOCK HAZARD
	THREE PHASE		
	DIRECT CURRENT		

CASE FRONT CONTROLS

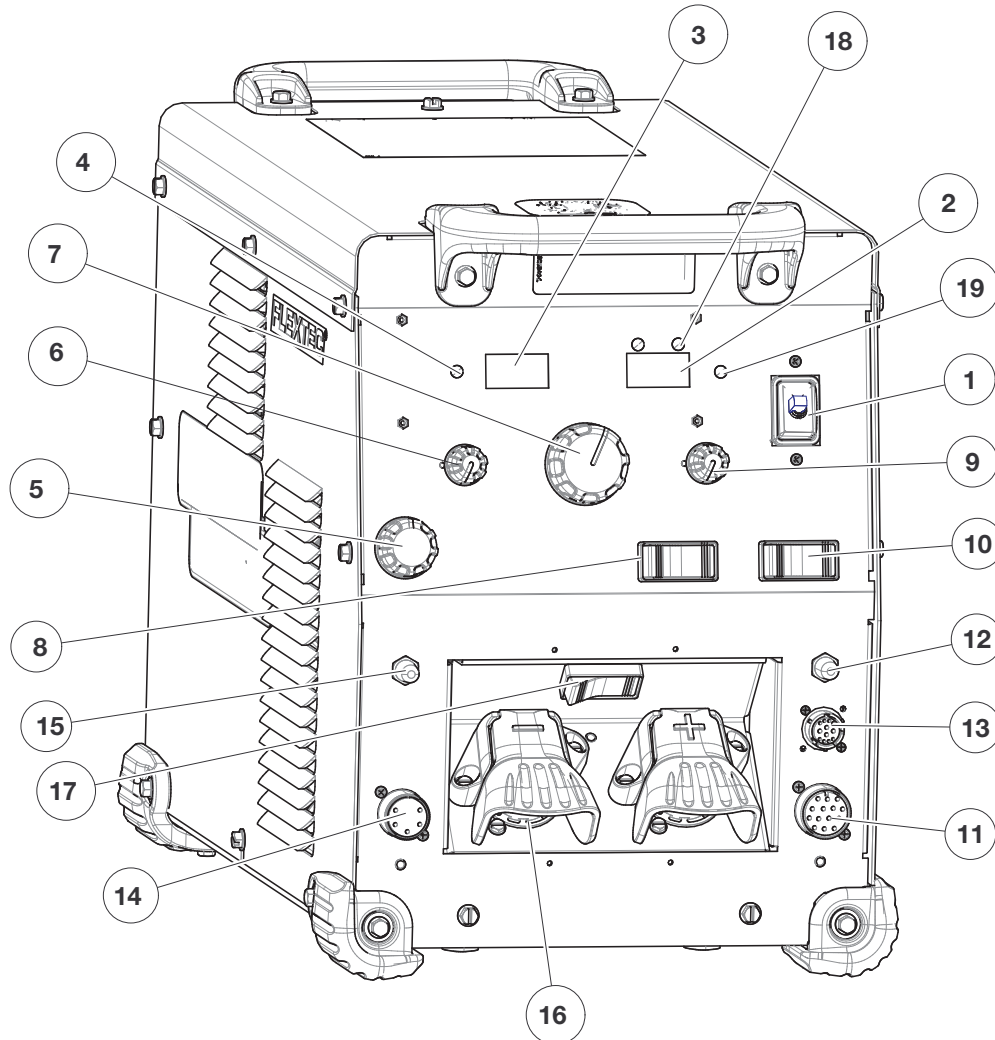

- 1. Power Switch:**
Controls input power to the Flextec® 500X.
- 2. Voltage LCD Display**
- 3. Amperage LCD Display**
- 4. Thermal LED:**
A yellow light that comes on when an over temperature situation occurs.
Output is disabled until the machine cools down.
When cool, the light goes out and output is enabled.
- 5. Weld Process Selector Switch:**
A rotary switch that toggles through the 5 available weld modes for the Flextec® 500X – CC-SMAW; CC-GTAW; CV; CV-Innershield; ArcLink.
- 6. Hot Start Control Dial:**
Full range selection of hot start from 0 to 10.
- 7. Output Control Dial:**
Sets the Output Current or Voltage for the selected Weld Process.
- 8. Local/Remote Selector Toggle Switch:**
Sets the control of the output to local (output control knob) or remote (K857 hand amptrol or K870 foot amptrol through the 12-pin or 14-pin circular connectors).
- 9. Arc Force Control Dial:**
Full range selection of arc force from -10 to +10.
- 10. Weld Terminals On/Remote selector switch.**
- 11. 14-pin wire feeder circular connector.**
- 12. Circuit breaker reset button for the 14-pin wire feeder connector.**
- 13. 12-pin remote circular connector.**
- 14. 5-pin ArcLink wire feeder circular connector.**
- 15. Circuit breaker reset button for the 5-pin wire feeder connector.**
- 16. Positive and negative welding output studs.**
- 17. Wire Feeder Voltmeter polarity selection switch.** Orients work sense lead for proper readout on control cable feeders with volt meters. Should match electrode polarity.
- 18. VRD LED indicators.**
- 19. CrossLine Communication Indicator.**

CASE BACK CONTROLS

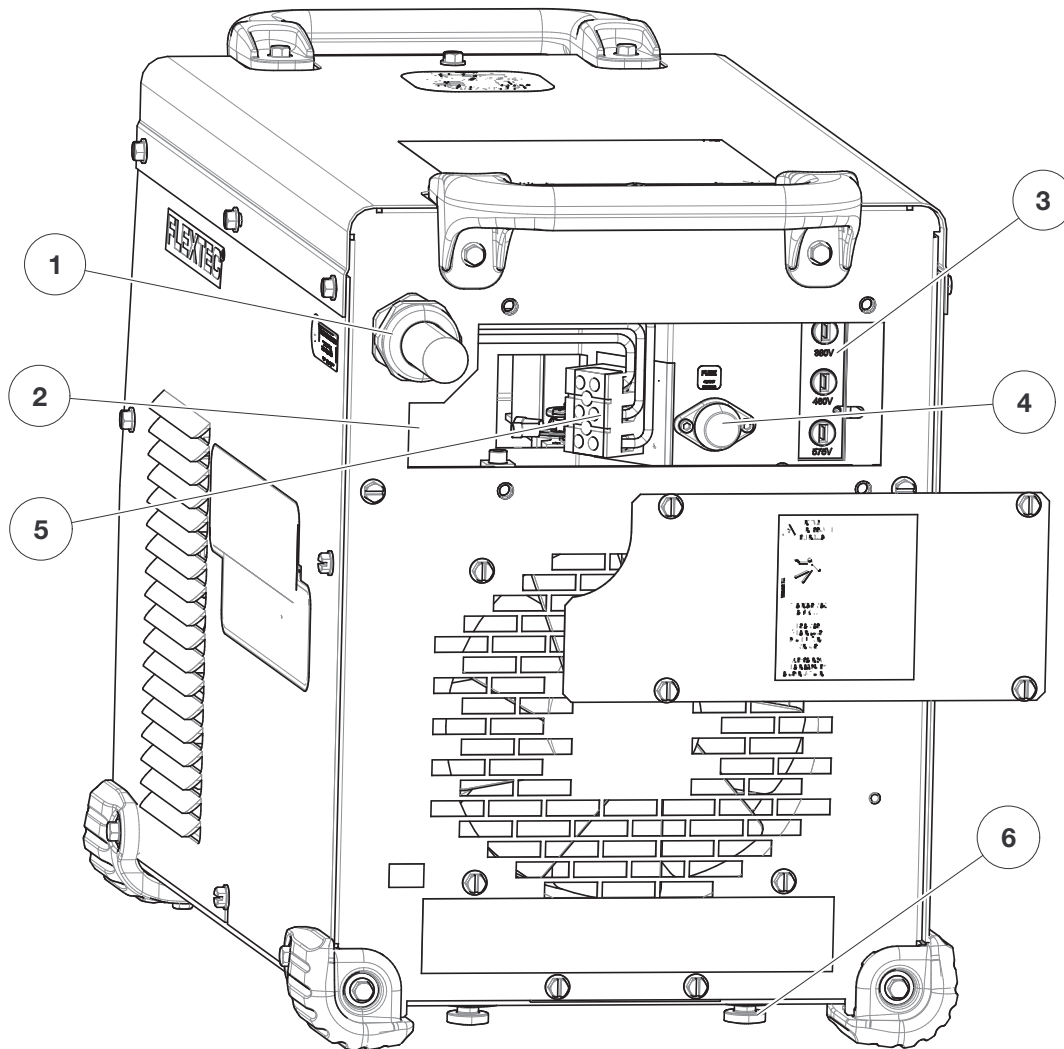

1. **Input Power Cord Access Hole**
2. **Access Panel** – Allows access for connecting input power and configuring the machine
3. **Input Power Reconnect** – Configures the machine for the input supply voltage
4. **Input Power Fuse Protection**
5. **Input Power Connection Terminal Block**
6. **OPTION** – Locking Foot Kit

INTERNAL CONTROLS

Internal Controls Description

The User Interface pc board has one bank of dip switches (See Figure A.1). As shipped from the factory and under normal conditions, the dip switches are all in the 'off' position (Figure A.2). There are 2 instances that require a change of the dip switch.

1. Enter VRD Mode (VRD Enabled) in CC.
 - a. Turn switch #5 to the 'ON' Position (See Figure A.3).
2. Enter VRD Mode (VRD Enabled) in CV.
 - a. Turn switch #6 to the 'ON' position (See Figure A.4).

Dip Switch Location on User Interface PCB

Figure A.1

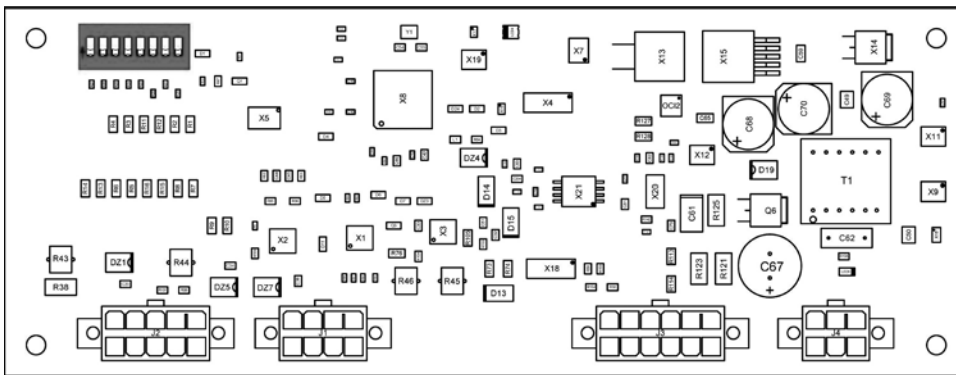

Figure A.2

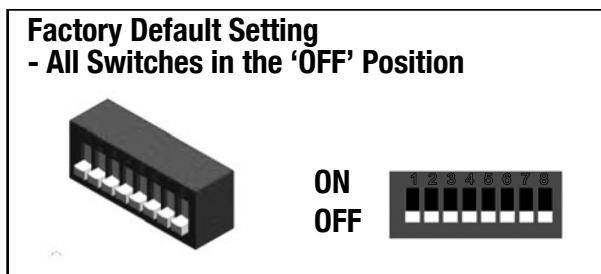

Figure A4

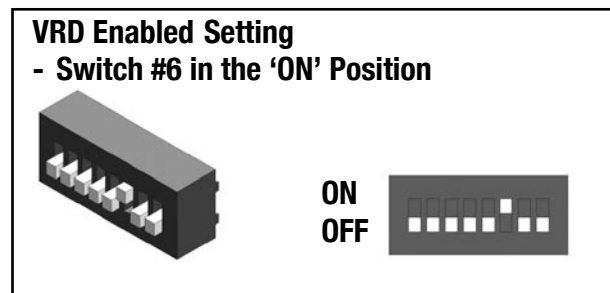
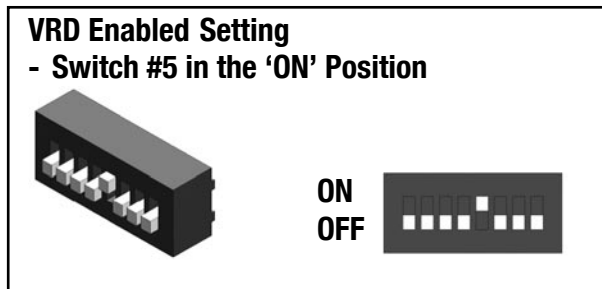

Figure A.3



DUTY CYCLE

The Flextec® 500X is capable of welding at a 100% duty cycle (continuous welding) at 450 Amps rated output.

The 60% duty cycle rating is 500 amps (based off of a ten minute cycle – 6 minutes on time and 4 minutes off time). The maximum output of the machine is 500 amps.

The Flextec® 500X is also rated for Desert Duty, elevated temperature operation, in a 55°C ambient. The machine is derated for this application.

COMMON WELDING PROCEDURES

MAKING A WELD

The Flextec® 500X is a multi-process inverter welder. The Weld Process Selector Switch is used to set the desired weld mode.

The Flextec® 500X has 5 selectable welding modes:

1. **SMAW** – This is a CC (constant current) weld mode used for the SMAW stick welding process.
2. **GTAW** – This is a CC (constant current) weld mode used for the GTAW tig welding process.
3. **CV** – This is CV (constant voltage) weld mode used for welding the GMAW mig welding process and the FCAW-GS, flux cored gas shielded welding process.
4. **CV-Innershield** – This is a CV (constant voltage) weld mode used for welding the FCAW-SS, flux cored self shielded welding process
5. **ArcLink** – This weld mode position is used to unlock synergic modes when combined with an ArcLink wire feeder.
6. **Constant Current Test Mode** – When the switch is in the ArcLink position with no ArcLink feeder present, the Flextec® will go into constant current test mode. This can be used to verify the calibration of the Flextec®.

The machine is also capable of gouging. Gouging can be done in either the SMAW mode or the CV and CV-Innershield modes.

In addition to the Weld Mode Selector switch, a hot start dial, output control dial and arc control dial are provided to setup and fine tune the welding procedure.

DEFINITION OF WELDING MODES

NON-SYNERGIC WELDING MODES

- A Non-synergic welding mode requires all welding process variables to be set by the operator.

SYNERGIC WELDING MODES

- A Synergic welding mode offers the simplicity of single knob control. The machine will select the correct voltage and amperage based on the wire feed speed (WFS) set by the operator.

WELD CONTROLS AND DISPLAYS

Weld Process Selector Switch

5 Position switch used to select the welding process

Hot Start Dial

The Hot Start control regulates the starting current at arc initiation. Hot Start can be set to '0' and no additional current is added at arc start. Increasing from 0 to 10 will increase the additional current (relative to the preset current) that is added at arc initiation.

Arc Control Dial

Full range selection of arc control from -10 to +10. In CV mode, this control is an inductance control. In stick mode, the control adjusts the arc force.

Output Control Dial

Output control is conducted via a single turn potentiometer.

Adjustment is indicated by the meters.

When in remote modes, this control sets the maximum welding current or voltage output. Full depression of a foot or hand amptrol results in the preset level of current or voltage.

Volt Display Meter

- Prior to CV operation (current flow), the meter displays desired preset voltage value (+/- .1V).
- Prior to STICK or TIG operation, the meter displays four dashes if the output has not been turned on.
- During welding, this meter displays actual average volts.
- After welding, the meter holds the actual voltage value for 5 seconds. The displays blink indicating that the machine is in the "Hold" period.
- Output adjustment while in the "hold" period results in the "prior to operation" characteristics.

Amperage Display Meter

- Prior to STICK or TIG operation (current flow), the meter displays preset current value.
- Prior to CV operation, the meter displays four dashes indicating non-presettable AMPS.
- During welding, this meter displays actual average amps.
- After welding, the meter holds the actual current value for 5 seconds. The displays blink indicating that the machine is in the "Hold" period.
- Output adjustment while in the "hold" period results in the "prior to operation" characteristics

Weld Terminals On/Remote Toggle Switch

- This switch determines the trigger location.
- When set to the 'ON' position, the weld terminals are at OCV (open circuit voltage) and ready to weld.
- When set to the 'remote' position, output is enabled through a remote trigger such as the guntrigger on a wire feeder.

Control - Local/Remote Toggle Switch

- Set the switch to 'local' to control output at the Flextec® via the Output Control dial.
- Set the switch to 'remote' to control output via a remote device (K857 hand amptrol or K870 foot amptrol) connected to the 6-pin remote connector or a wire feeder connected to the 14-pin connector.

CrossLinc LED

- The Flextec 500X automatically recognizes when a CrossLinc equipped accessory is connected to it. It will communicate on power up and the CrossLinc LED will illuminate.

Wire Feeder Voltmeter Polarity Switch

- This switch configures the 21 sense lead in the 14 pin connector to the work weld terminal of the machine. It also configures the 292 lead to the User Interface board to determine if voltage sensing needs to be configured for Electrode Negative Polarity operation in "ArcLink" mode. This should be set to the same polarity as the electrode, typically:

Process	Polarity
GMAW	+
SMAW	+
TIG	-
FCAW-S	-

Thermal Light

- This status light indicates when the power source has been driven into thermal overload. If the output terminals were "ON", the output will be turned back on once the unit cools down to an acceptable temperature level. If the unit was operating in the "REMOTE" mode, the trigger will need to be opened before or after the thermal has cleared and closed after the machine has cooled down to an acceptable temperature to re-establish output.

VRD Lights

- There are two indicator lights on the case front of the Flextec® 500X above the Voltage display to indicate the status of VRD operation. As shipped, the VRD function is disabled. VRD is enabled by setting dip switch number 5 to the on position on the User Interface P.C. board. When VRD is active, a green light indicates the open circuit voltage is less than 35V peak, a red light indicates the OCV is at or above 35V peak, Both lights will illuminate for 5 seconds upon power up. The behavior of the VRD lights is listed in the table below (**Figure C.1**).

Figure C.1

		VRD™ Indicator Lights	
Mode		VRD™ "ON"	VRD™ "OFF"
CC-SMAW CC-GTAW	OCV	Green (OCV reduced)	No lights are active
	While Welding	Green or Red (depends on welding voltage)*	
CV-GAS CV-Innershield	OCV	Weld Terminals Locally Controlled Weld Terminals 'ON' Green or Red (depends on open circuit voltage)**	No lights are active
		Weld Terminals Remotely Controlled Gun Trigger Closed Green or Red (depends on open circuit voltage)**	
		Weld Terminals Remotely Controlled Gun Trigger Open Green (OCV reduced)	
	While Welding	Green or Red (depends on welding voltage)*	
ArcLink	OCV	Gun Trigger Closed Green or Red (depends on open circuit voltage)**	No lights are active
		Gun Trigger Open Green (OCV reduced)	
		While Welding	

* It is normal for the lights to alternate between colors while welding.

** It is normal for the lights to alternate during OCV preset adjustment, depending on preset voltage level.

ACCESSORIES

GENERAL OPTIONS

K2149-1 Work Lead Package. 4/0 cable lugged at one end with work clamp attached at the other end. 15 ft. (4.6 m) length.

K1842-10 Weld Power Cable. Lug to lug, 3/0, 600A, 60% duty cycle. 10 ft. (3.0 m).

K3059-2 Inverter and Wire Feeder Cart. Rear-wheeled cart with front casters and gas bottle platform. Convenient handles allow for easy cable storage. Small footprint fits through 30 in. (762 mm) door. Not intended for use with double head wire feeders.

K3059-3 Dual Cylinder Inverter & Wire Feeder Cart. Rear-wheeled cart with front casters and dual cylinder platform. Convenient handles allow for easy cable storage. Small footprint fits through 30 inch (762mm) door.

K3091-1 Multi-Process Switch. Easily switch between CC and CV processes.

K3129-2 Flextec® 500X CE Filter Kit (380-575 Vac)

K586-1 Deluxe Adjustable Gas Regulator & Hose Kit. Accommodates CO₂, Argon, or Argon-blend gas cylinders. Includes a cylinder pressure gauge, dual scale flow gauge and 4.3ft (1.3m) gas hose.

3100211 Harris Argon Flowmeter Regulator and Hose Kit

K2909-1 12-pin to 6-pin Adapter

K2910-1 7-pin to 12-pin Adapter

FUME EXTRACTING SYSTEMS

K3019-1 Arc Tracker. The Arc Tracker monitors information regarding your welding arc by connecting it between any DC welding power source and the work clamp.

Weld Fume Control Solutions. Lincoln Electric offers a wide variety of welding fume control solutions, ranging from portable systems easily wheeled around the shop to shop-wide central systems servicing many dedicated welding stations.

STICK OPTIONS

K704 Accessory Kit. For stick welding. Includes 35 ft. (10.7 m) 2/0 electrode cable with lug, 30 ft. (9.1 m) 2/0 work cable with lugs, head shield, filter plate, cover plate, work clamp and electrode holder. 400 amp capacity.

K875 Accessory Kit. For stick welding. Includes 20 ft. (6.1 m) #6 electrode cable with lug, 15 ft. (4.6 m) #6 work cable with lugs, head shield, filter plate, cover plate, work clamp and electrode holder. 150 amp capacity.

K857-2 12-pin Remote Output Control with Universal Connector. Permits remote adjustment of output.

K4345-1 Crossline Remote

K857-3 Remote Output Control. 12-Pin, 100 ft.

TIG OPTIONS

Pro-Torch™ TIG Torches – PTA-9, PTA-17, PTA-26 – 2 piece power cord.

K870-2 Foot Amptrol®. Provides 25 ft. (7.6 m) of remote current control for TIG welding. (12-pin plug connection).

K963-4 Hand Amptrol® - Provides 25 ft. (7.6 m) of remote current control for TIG welding. (12-pin plug connection)

K814 Arc Start Switch - May be used in place of the Foot or Hand Amptrol®. Comes with a 25 ft. (7.6m) cable. Attaches to the TIG torch for convenient finger control to start and stop the weld cycle at the current set on the machine.

MAINTENANCE

WARNING



ELECTRIC SHOCK can kill.

- Before carrying out service, maintenance and/or repair jobs, fully disconnect power to the machine.
- Do not touch electrically hot parts.



Only Qualified personnel should perform this maintenance.

VISUAL INSPECTION

Clean interior of machine with a low pressure air stream. Make a thorough inspection of all components.

Look for signs of overheating, broken leads or other obvious problems. Many problems can be uncovered with a good visual inspection.

ROUTINE MAINTENANCE

At least every six months (this time period maybe reduced based on environment and usage) the machine should be cleaned with a low pressure air stream. Keeping the machine clean will result in cooler operation and higher reliability. Be sure to clean the following areas:

- All printed circuit boards
- Power switch
- Main transformer
- Input rectifier
- Heatsink fins
- Auxiliary Transformer
- Reconnect Switch Area
- Fan (Blow air through the rear louvers)

Examine the sheet metal case for dents or breakage. Repair the case as required. Keep the case in good condition to ensure that high voltage parts are protected and correct spacing is maintained throughout. All external sheet metal screws must be in place to ensure case strength and electrical ground continuity.

PERIODIC MAINTENANCE

Thermal Protection

Thermostats protect the machine from excessive operating temperatures. Excessive temperatures may be caused by a lack of cooling air or operating the machine beyond the duty cycle and output rating. If excessive operating temperature should occur, the thermostat will disable the output and run the cooling fan. The displays will remain energized during this time and the thermal light will be illuminated. Thermostats are self-resetting once the machine cools sufficiently. If the thermostat shutdown was caused by excessive output or duty cycle and the fan is operating normally, the Power Switch may be left on and the reset should occur within a 15 minute period.



If for any reason you do not understand the procedures or are unable to perform the maintenance or repairs safely, contact your Lincoln Authorized Service Facility for technical troubleshooting assistance before you proceed.

WWW.LINCOLNELECTRIC.COM/LOCATOR

TROUBLESHOOTING

HOW TO USE TROUBLESHOOTING GUIDE

WARNING

Service and Repair should only be performed by Lincoln Electric Factory Trained Personnel. Unauthorized repairs performed on this equipment may result in danger to the technician and machine operator and will invalidate your factory warranty. For your safety and to avoid Electrical Shock, please observe all safety notes and precautions detailed throughout this manual.

This Troubleshooting Guide is provided to help you locate and repair possible machine malfunctions. Simply follow the three-step procedure listed below.

Step 1. LOCATE PROBLEM (SYMPTOM).

Look under the column labeled “PROBLEM (SYMPTOMS)”. This column describes possible symptoms that the machine may exhibit. Find the listing that best describes the symptom that the machine is exhibiting.

Step 2. POSSIBLE CAUSE.

The second column labeled “POSSIBLE CAUSE” lists the obvious external possibilities that may contribute to the machine symptom.

Step 3. RECOMMENDED COURSE OF ACTION

This column provides a course of action for the Possible Cause, generally it states to contact your local Lincoln Authorized Field Service Facility.

If you do not understand or are unable to perform the Recommended Course of Action safely, contact your local Lincoln Authorized Field Service Facility.



If for any reason you do not understand the test procedures or are unable to perform the tests/repairs safely, contact your Lincoln Authorized Service Facility for technical troubleshooting assistance before you proceed.

WWW.LINCOLNELECTRIC.COM/LOCATOR

ERROR CODES

Errors are displayed on the user interface. In addition, there are status lights on the User Interface PC board and the Switch PC board that contain error sequences.

The status lights on the User Interface board and the Switch board are dual-color LED's. Normal operation for each is steady green.

Error conditions are indicated in the following chart.

Included in this section is information about the status lights and some basic troubleshooting charts for both machine and weld performance.

Error Code	Description	Corrective Action
6	No CAN messages from Power Source	Communication from the Power Source failed before mapping was complete.
18	ArcLink Auto-Mapping Failed	The machine could not properly configure the devices that are attached to it. This configuration problem could be caused by the type of devices that are connected to the machine or a required device that is not connected.
21	Device that controls sequence of the welding operation halted due to an error	A component of the system encountered an error during the welding sequence and caused the system to stop. The component with the error could be a wire drive, a user interface or some other part of the system.
31	Primary Overcurrent	Peak current through the transformer primary has exceeded its threshold.
36	Thermal Fault	Machine shutoff output due to elevated internal temperature.
45	Output Voltage Limit Exceeded	During OCV, the voltage at the studs exceeded the allowable levels.
213	Communication Fault	CAN communication between the User Interface PC board and the Switch PC board has been interrupted.
711	DC Link Capacitor Over/Under Voltage	The voltage on the main DC link capacitors housed on the switchboard has either gone too high or too low.
713	Misconnect Protection - UI detected Aux. Trans. Voltage too high	Occurs upon power up when the supply voltage to the User Interface PC board exceeds an acceptable level.
714	Misconnect Protection - UI detected Aux. Trans. Voltage too low	Occurs upon power up when the supply voltage to the User Interface PC board is below an acceptable level.
719	Switch PC Board Error	The Switch PC board experienced an internal error.

If any of these conditions persist contact an authorized Lincoln Field Service Shop.



If for any reason you do not understand the test procedures or are unable to perform the tests/repairs safely, contact your Lincoln Authorized Service Facility for technical troubleshooting assistance before you proceed.

WWW.LINCOLNELECTRIC.COM/LOCATOR

Observe all Safety Guidelines detailed throughout this manual

PROBLEMS (SYMPTOMS)	POSSIBLE CAUSE	RECOMMENDED COURSE OF ACTION
Major physical or electrical damage is evident when the sheet metal covers are removed.	1. Contact your local authorized Lincoln Electric Field Service facility for technical assistance.	1. If all recommended possible areas of mis-adjustment have been checked and the problem persists, Contact your local Lincoln Authorized Field Service Facility.
Machine won't weld, can't get any output.	1. If the displays show an Err ### see the fault section for corrective action. 2. If the thermal symbol is lit refer to the thermal section. 3. If the output terminals are in remote control switch to "ON" and check for output voltage. If output voltage is now present check for correct remote control connection and operation.	
Thermal symbol is lit	1. Check for proper fan operation. - Check for material blocking intake or exhaust louvers. - Blow air in the rear louvers to clear dirt from the fan. Note: The Fan As Needed circuitry automatically shuts off the fan 5 minutes after welding has stopped. 2. Welding output ratings may have been exceeded. Allow the machine to cool down and reset.	
Wire feeder won't work. Apparently no power to wire feeder	1. Check the 42V or ArcLink connectors on the case front of the machine to make sure it is properly connected. 2. Check circuit breakers by the wire feeder receptacles on the case front of the machine. Reset if necessary. 3. Check the control cable between the power source and the wire feeder for continuity.	



If for any reason you do not understand the test procedures or are unable to perform the tests/repairs safely, contact your Lincoln Authorized Service Facility for technical troubleshooting assistance before you proceed.

WWW.LINCOLNELECTRIC.COM/LOCATOR

FLEXTEC 500X WIRING DIAGRAM

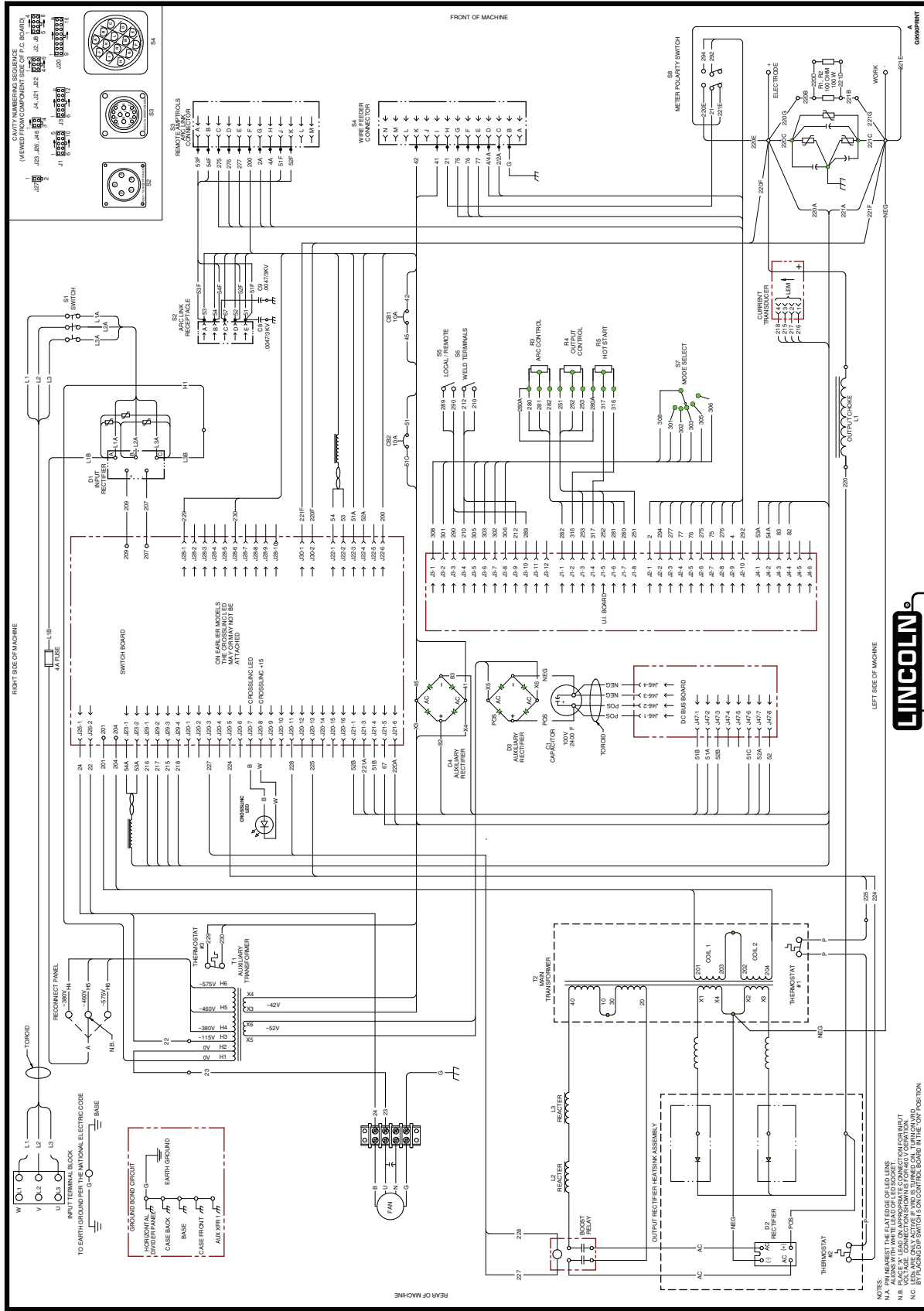

NOTE: This diagram is for reference only. It may not be accurate for all machines covered by this manual. The specific diagram for a particular code is pasted inside the machine on one of the enclosure panels. If the diagram is illegible, write to the Service Department for a replacement. Give the equipment code number.

ACROSS THE ARC WIRE FEEDER SETUP WITH FLEXTEC 500X CONNECTION DIAGRAM

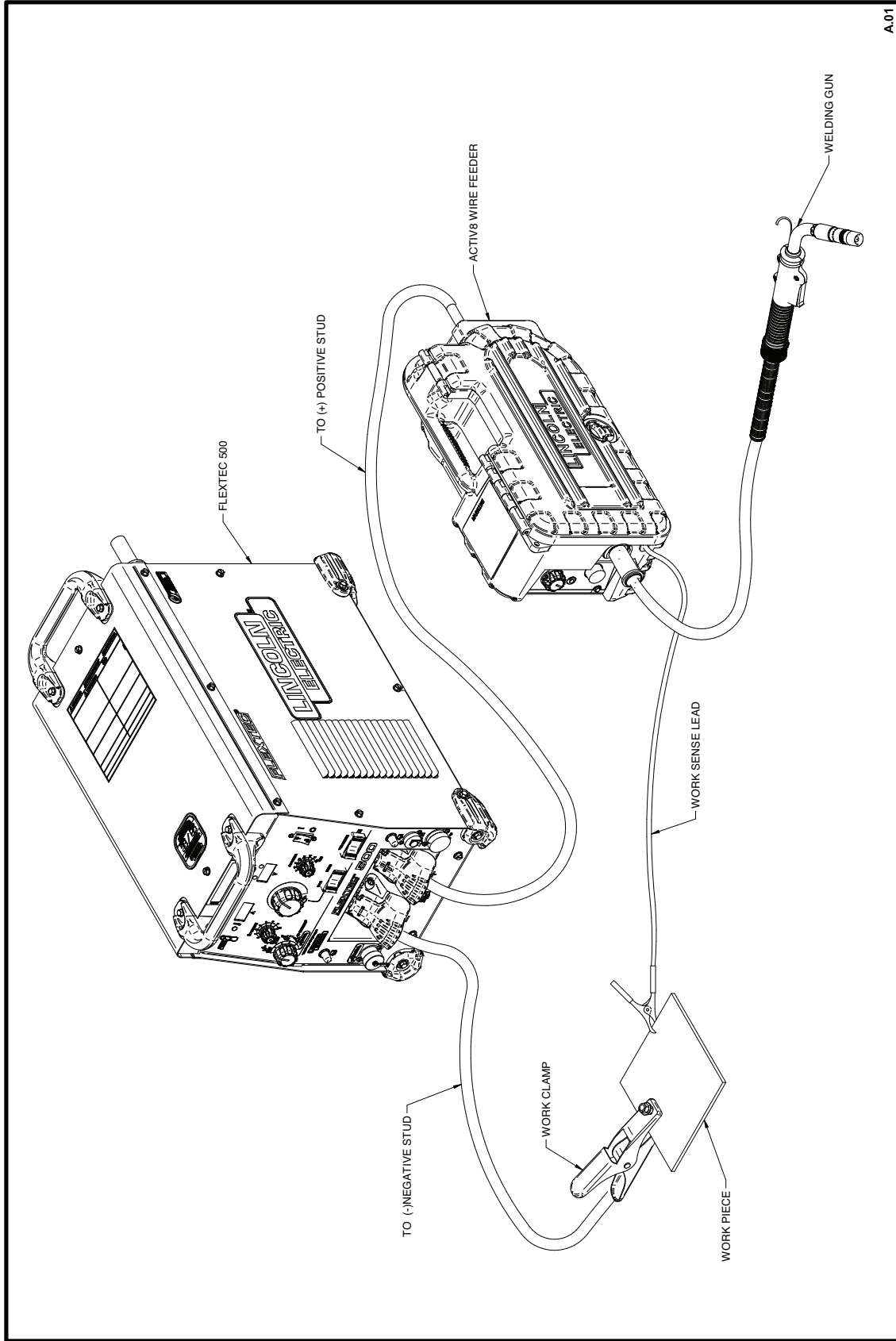

A.01

L16790

LN10 /DH10 SETUP WITH FLEXTEC 500X CONNECTION DIAGRAM

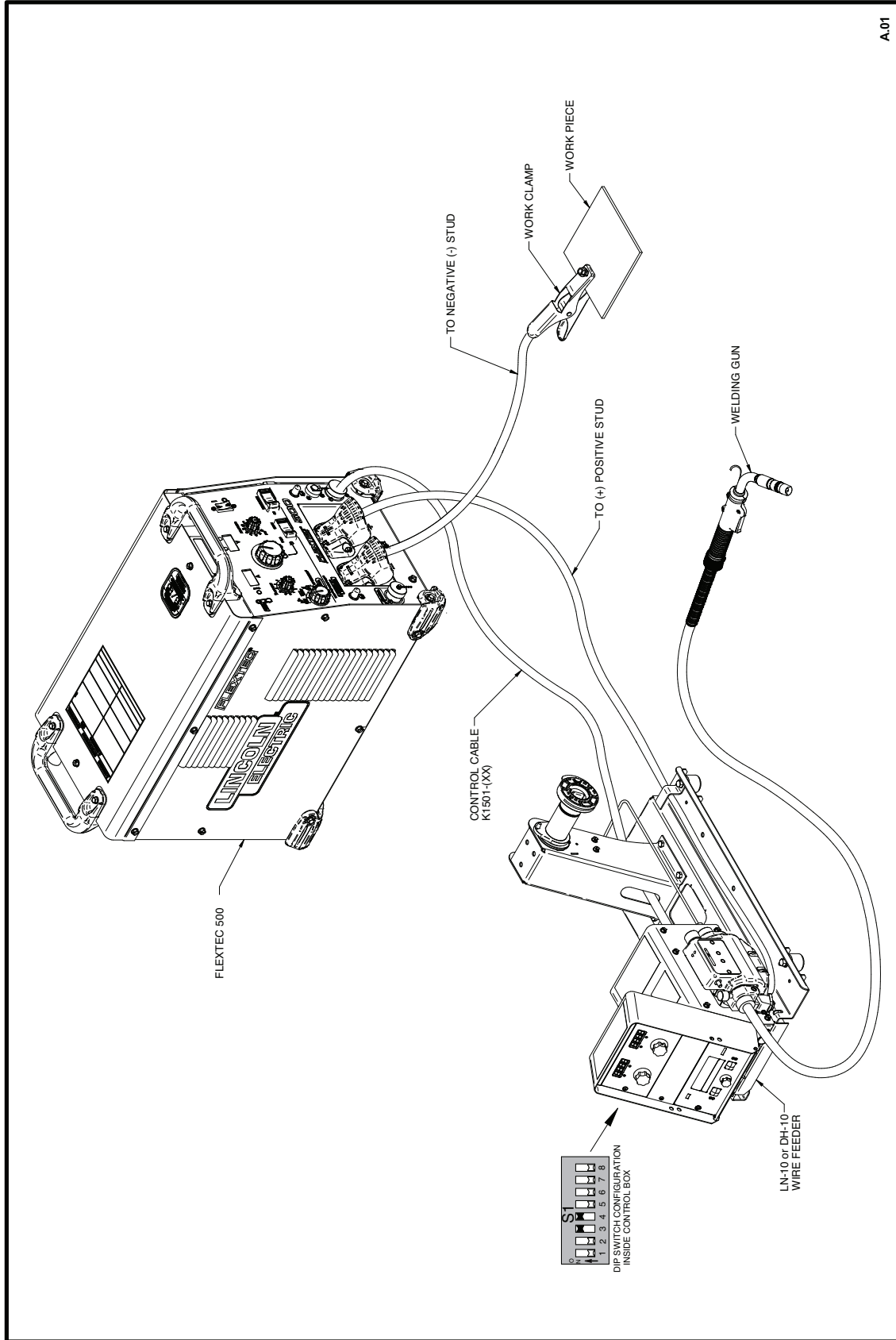

A.01

L16790

FLEXFEED 74 HT SETUP WITH FLEXTEC 500X CONNECTION DIAGRAM

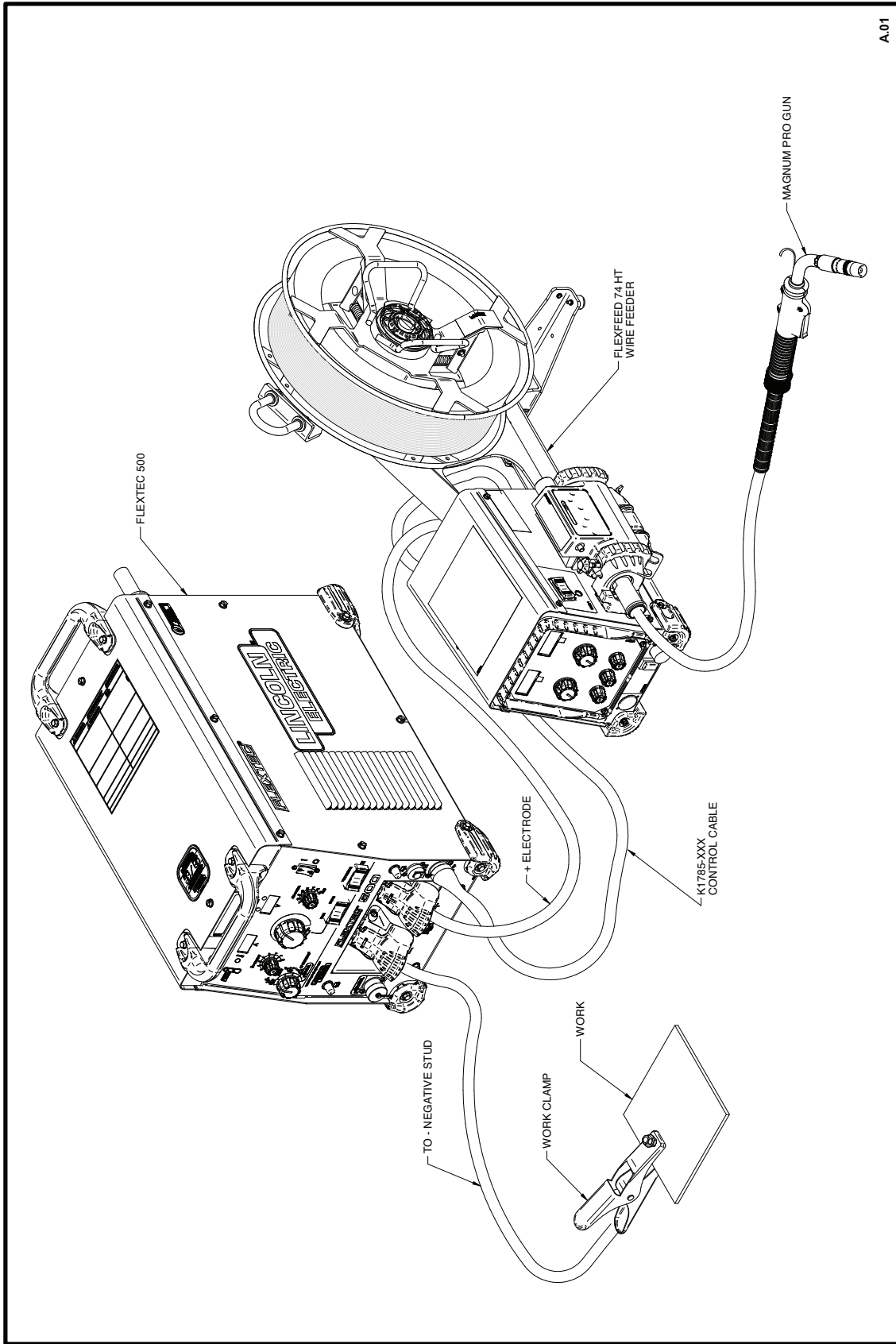

A.01

L16790

LN25 PRO DUAL POWER SETUP WITH FLEXTEC 500X CONNECTION DIAGRAM

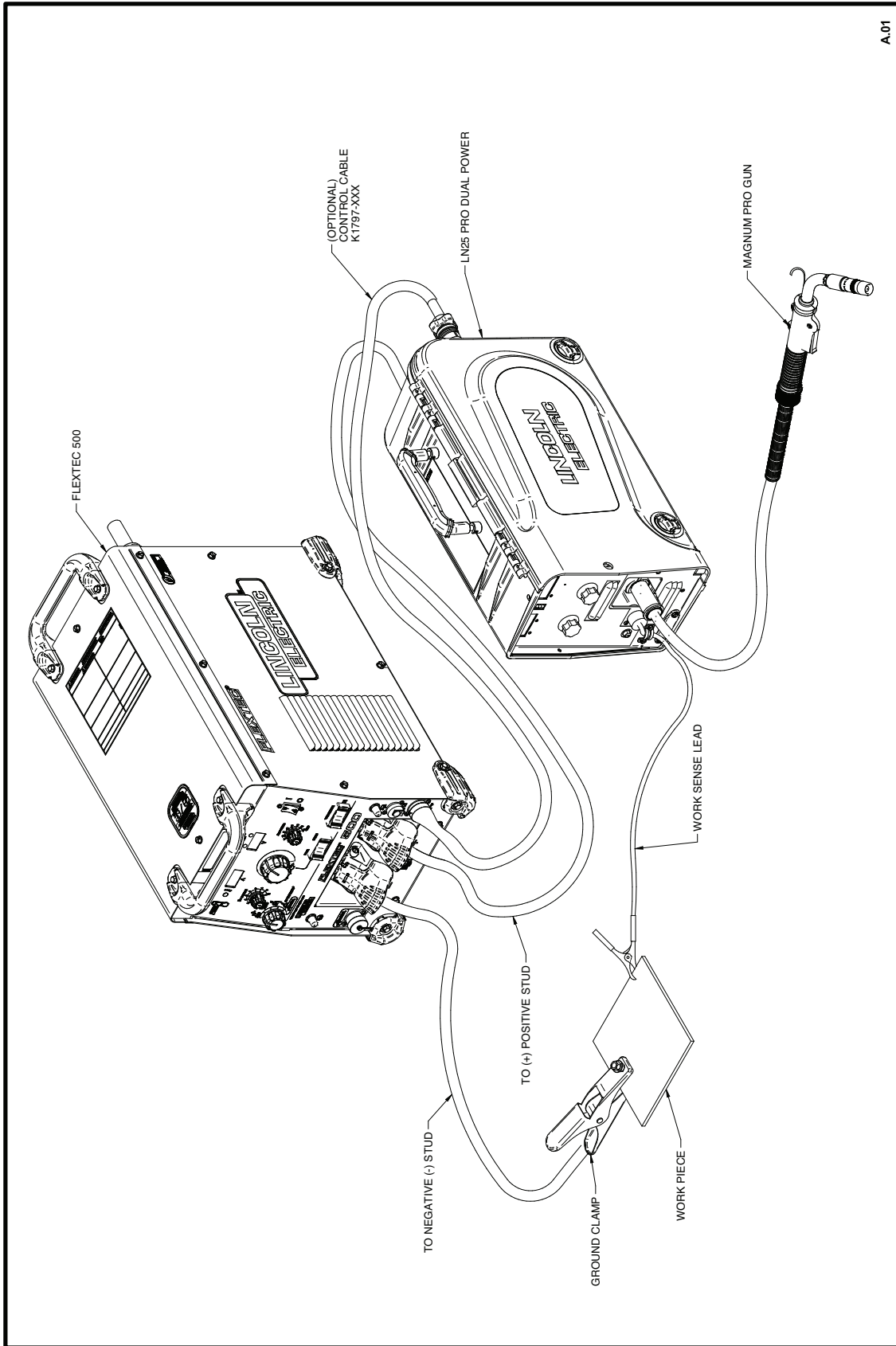

A.01

L16790

PF84 SETUP WITH FLEXTEC 500X CONNECTION DIAGRAM

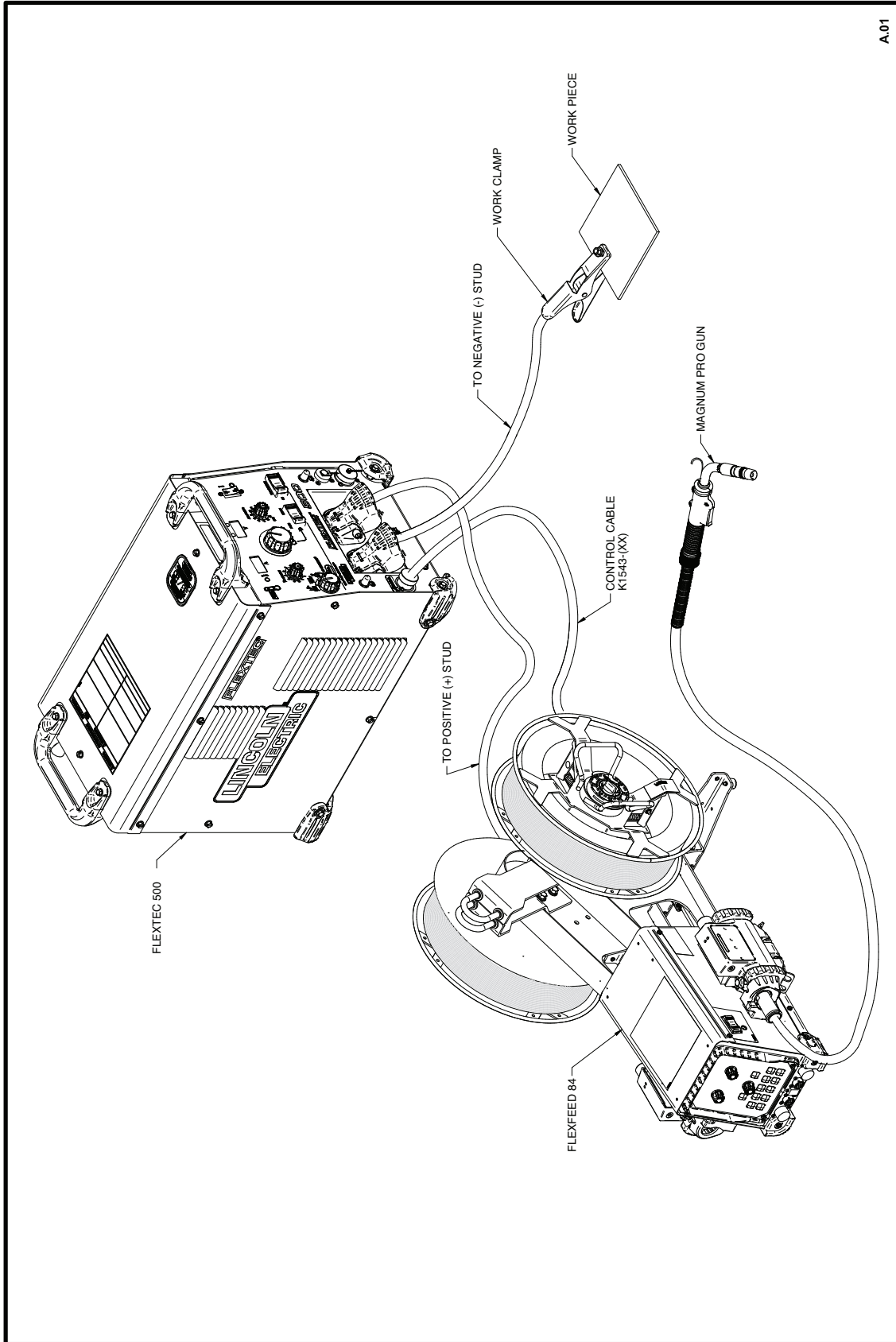

A.01

L16790

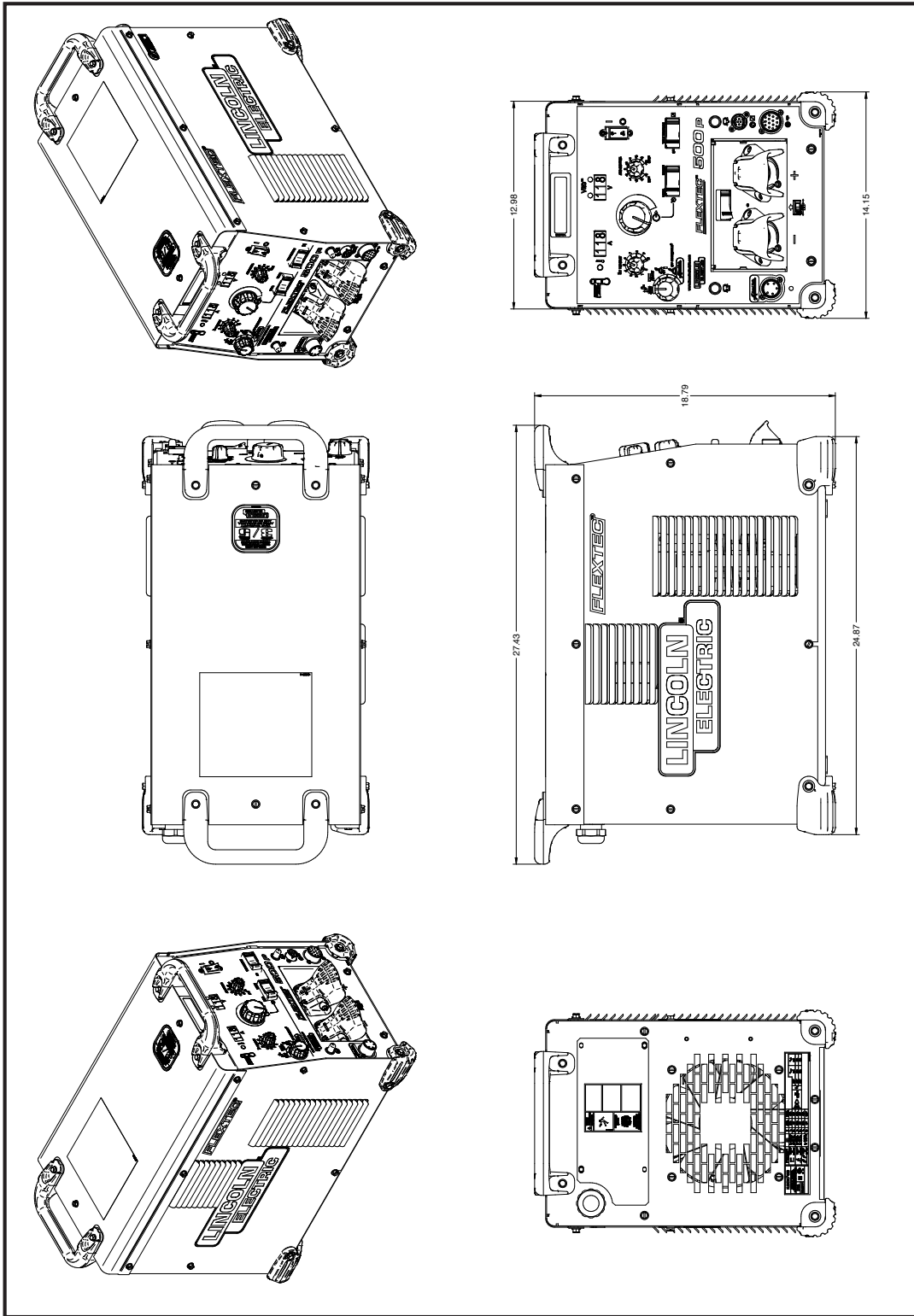

NOTE: This diagram is for reference only. It may not be accurate for all machines covered by this manual. The specific diagram for a particular code is pasted inside the machine on one of the enclosure panels. If the diagram is illegible, write to the Service Department for a replacement. Give the equipment code number.

			
WARNING	<ul style="list-style-type: none"> Do not touch electrically live parts or electrode with skin or wet clothing. Insulate yourself from work and ground. 	<ul style="list-style-type: none"> Keep flammable materials away. 	<ul style="list-style-type: none"> Wear eye, ear and body protection.
Spanish AVISO DE PRECAUCION	<ul style="list-style-type: none"> No toque las partes o los electrodos bajo carga con la piel o ropa mojada. Aíslese del trabajo y de la tierra. 	<ul style="list-style-type: none"> Mantenga el material combustible fuera del área de trabajo. 	<ul style="list-style-type: none"> Protéjase los ojos, los oídos y el cuerpo.
French ATTENTION	<ul style="list-style-type: none"> Ne laissez ni la peau ni des vêtements mouillés entrer en contact avec des pièces sous tension. Isolez-vous du travail et de la terre. 	<ul style="list-style-type: none"> Gardez à l'écart de tout matériel inflammable. 	<ul style="list-style-type: none"> Protégez vos yeux, vos oreilles et votre corps.
German WARNUNG	<ul style="list-style-type: none"> Berühren Sie keine stromführenden Teile oder Elektroden mit Ihrem Körper oder feuchter Kleidung! Isolieren Sie sich von den Elektroden und dem Erdboden! 	<ul style="list-style-type: none"> Entfernen Sie brennbares Material! 	<ul style="list-style-type: none"> Tragen Sie Augen-, Ohren- und Körperschutz!
Portuguese ATENÇÃO	<ul style="list-style-type: none"> Não toque partes elétricas e electrodos com a pele ou roupa molhada. Isole-se da peça e terra. 	<ul style="list-style-type: none"> Mantenha inflamáveis bem guardados. 	<ul style="list-style-type: none"> Use proteção para a vista, ouvido e corpo.
Japanese 注意事項	<ul style="list-style-type: none"> 通電中の電気部品、又は溶材にヒブやぬれた布で触れないこと。 施工物やアースから身体が絶縁されている様にして下さい。 	<ul style="list-style-type: none"> 燃えやすいものの側での溶接作業は絶対にしてはなりません。 	<ul style="list-style-type: none"> 目、耳及び身体に保護具をして下さい。
Chinese 警告	<ul style="list-style-type: none"> 皮肤或湿衣物切勿接触带电部件及焊条。 使你自已与地面和工件绝缘。 	<ul style="list-style-type: none"> 把一切易燃物品移离工作场所。 	<ul style="list-style-type: none"> 佩戴眼、耳及身体劳动保护用具。
Korean 위험	<ul style="list-style-type: none"> 전도체나 용접봉을 젖은 헝겍 또는 피부로 절대 접촉치 마십시오. 모재와 접지를 접촉치 마십시오. 	<ul style="list-style-type: none"> 인화성 물질을 접근시키지 마십시오. 	<ul style="list-style-type: none"> 눈, 귀와 몸에 보호장구를 착용하십시오.
Arabic تحذير	<ul style="list-style-type: none"> لا تلمس الاجزاء التي يسري فيها التيار الكهربائي أو الألكترود بجسدك أو بالملابس المبللة بالماء. ضع عازلا على جسمك خلال العمل. 	<ul style="list-style-type: none"> ضع المواد القابلة للاشتعال في مكان بعيد. 	<ul style="list-style-type: none"> ضع أدوات وملابس واقية على عينيك وأذنيك وجسمك.

READ AND UNDERSTAND THE MANUFACTURER'S INSTRUCTION FOR THIS EQUIPMENT AND THE CONSUMABLES TO BE USED AND FOLLOW YOUR EMPLOYER'S SAFETY PRACTICES.

SE RECOMIENDA LEER Y ENTENDER LAS INSTRUCCIONES DEL FABRICANTE PARA EL USO DE ESTE EQUIPO Y LOS CONSUMIBLES QUE VA A UTILIZAR, SIGA LAS MEDIDAS DE SEGURIDAD DE SU SUPERVISOR.

LISEZ ET COMPRENEZ LES INSTRUCTIONS DU FABRICANT EN CE QUI REGARDE CET EQUIPMENT ET LES PRODUITS A ETRE EMPLOYES ET SUIVEZ LES PROCEDURES DE SECURITE DE VOTRE EMPLOYEUR.

LESEN SIE UND BEFOLGEN SIE DIE BETRIEBSANLEITUNG DER ANLAGE UND DEN ELEKTRODENEINSATZ DES HERSTELLERS. DIE UNFALLVERHÜTUNGSVORSCHRIFTEN DES ARBEITGEBERS SIND EBENFALLS ZU BEACHTEN.

			
<ul style="list-style-type: none"> ● Keep your head out of fumes. ● Use ventilation or exhaust to remove fumes from breathing zone. 	<ul style="list-style-type: none"> ● Turn power off before servicing. 	<ul style="list-style-type: none"> ● Do not operate with panel open or guards off. 	WARNING
<ul style="list-style-type: none"> ● Los humos fuera de la zona de respiración. ● Mantenga la cabeza fuera de los humos. Utilice ventilación o aspiración para gases. 	<ul style="list-style-type: none"> ● Desconectar el cable de alimentación de poder de la máquina antes de iniciar cualquier servicio. 	<ul style="list-style-type: none"> ● No operar con panel abierto o guardas quitadas. 	Spanish AVISO DE PRECAUCION
<ul style="list-style-type: none"> ● Gardez la tête à l'écart des fumées. ● Utilisez un ventilateur ou un aspirateur pour ôter les fumées des zones de travail. 	<ul style="list-style-type: none"> ● Débranchez le courant avant l'entretien. 	<ul style="list-style-type: none"> ● N'opérez pas avec les panneaux ouverts ou avec les dispositifs de protection enlevés. 	French ATTENTION
<ul style="list-style-type: none"> ● Vermeiden Sie das Einatmen von Schweißrauch! ● Sorgen Sie für gute Be- und Entlüftung des Arbeitsplatzes! 	<ul style="list-style-type: none"> ● Strom vor Wartungsarbeiten abschalten! (Netzstrom völlig öffnen; Maschine anhalten!) 	<ul style="list-style-type: none"> ● Anlage nie ohne Schutzgehäuse oder Innenschutzverkleidung in Betrieb setzen! 	German WARNUNG
<ul style="list-style-type: none"> ● Mantenha seu rosto da fumaça. ● Use ventilação e exaustão para remover fumo da zona respiratória. 	<ul style="list-style-type: none"> ● Não opere com as tampas removidas. ● Desligue a corrente antes de fazer serviço. ● Não toque as partes elétricas nuas. 	<ul style="list-style-type: none"> ● Mantenha-se afastado das partes moventes. ● Não opere com os painéis abertos ou guardas removidas. 	Portuguese ATENÇÃO
<ul style="list-style-type: none"> ● ヒュームから頭を離すようにして下さい。 ● 換気や排煙に十分留意して下さい。 	<ul style="list-style-type: none"> ● メンテナンス・サービスに取りかかる際には、まず電源スイッチを必ず切して下さい。 	<ul style="list-style-type: none"> ● パネルやカバーを取り外したままで機械操作をしないで下さい。 	Japanese 注意事項
<ul style="list-style-type: none"> ● 頭部遠離煙霧。 ● 在呼吸區使用通風或排風器除煙。 	<ul style="list-style-type: none"> ● 維修前切斷電源。 	<ul style="list-style-type: none"> ● 儀表板打開或沒有安全罩時不準作業。 	Chinese 警告
<ul style="list-style-type: none"> ● 얼굴로부터 용접가스를 멀리하십시오. ● 호흡지역으로부터 용접가스를 제거하기 위해 가스제거기나 통풍기를 사용하십시오. 	<ul style="list-style-type: none"> ● 보수전에 전원을 차단하십시오. 	<ul style="list-style-type: none"> ● 판넬이 열린 상태로 작동치 마십시오. 	Korean 위험
<ul style="list-style-type: none"> ● ابعد رأسك بعيداً عن الدخان. ● استعمل التهوية أو جهاز ضغط الدخان للخارج لكي تبعد الدخان عن المنطقة التي تتنفس فيها. 	<ul style="list-style-type: none"> ● اقطع التيار الكهربائي قبل القيام بأية صيانة. 	<ul style="list-style-type: none"> ● لا تشغيل هذا الجهاز اذا كانت الاغطية الحديدية الواقية ليست عليه. 	Arabic تحذير

LEIA E COMPREENDA AS INSTRUÇÕES DO FABRICANTE PARA ESTE EQUIPAMENTO E AS PARTES DE USO, E SIGA AS PRÁTICAS DE SEGURANÇA DO EMPREGADOR.

使う機械や溶材のメーカーの指示書をよく読み、まず理解して下さい。そして貴社の安全規定に従って下さい。

請詳細閱讀並理解製造廠提供的說明以及應該使用的銀焊材料，並請遵守貴方的有關勞動保護規定。

이 제품에 동봉된 작업지침서를 숙지하시고 귀사의 작업자 안전수칙을 준수하시기 바랍니다.

اقرأ بتمعن وافهم تعليمات المصنع المنتج لهذه المعدات والمواد قبل استعمالها واتبع تعليمات الوقاية لصاحب العمل.

CUSTOMER ASSISTANCE POLICY

The business of The Lincoln Electric Company is manufacturing and selling high quality welding equipment, consumables, and cutting equipment. Our challenge is to meet the needs of our customers and to exceed their expectations. On occasion, purchasers may ask Lincoln Electric for advice or information about their use of our products. We respond to our customers based on the best information in our possession at that time. Lincoln Electric is not in a position to warrant or guarantee such advice, and assumes no liability, with respect to such information or advice. We expressly disclaim any warranty of any kind, including any warranty of fitness for any customer's particular purpose, with respect to such information or advice. As a matter of practical consideration, we also cannot assume any responsibility for updating or correcting any such information or advice once it has been given, nor does the provision of information or advice create, expand or alter any warranty with respect to the sale of our products.

Lincoln Electric is a responsive manufacturer, but the selection and use of specific products sold by Lincoln Electric is solely within the control of, and remains the sole responsibility of the customer. Many variables beyond the control of Lincoln Electric affect the results obtained in applying these types of fabrication methods and service requirements.

Subject to Change – This information is accurate to the best of our knowledge at the time of printing. Please refer to www.lincolnelectric.com for any updated information.



THE LINCOLN ELECTRIC COMPANY

22801 St. Clair Avenue • Cleveland, OH • 44117-1199 • U.S.A.
Phone: +1.216.481.8100 • www.lincolnelectric.com