



WELDLINE™

by Lincoln Electric

TIG TORCHES

PROTIG NG S & III S range







TIG TORCHES

PROTIG NG S & III S

PROTIG NGS & IIIS is our Premium range of torches for TIG applications, which are designed for Industrial use. Both models, PROTIG NG S - Ergonomic handle (EB), and PROTIG IIIS - round handle (RL), perfectly adapt to the different needs of the welder. Flexibility, comfort and customization of welding settings increase welding performance, and the unique expendables with proprietor design ensure longer lifetime.

The PROTIG range is manufactured according to high quality standards and includes 4 air cooled, and 3 water cooled versions.

PRODUCT ADVANTAGES

- ◆ Handle in dual component (*rubber*) for a better grip,
- ◆ High Quality components,
- ◆ Improved robustness,
- ◆ High flexibility cables with terminal part in leather, optional button modules.

APPLICATIONS

- ◆ Fabrication
- ◆ Construction
- ◆ Power Generation
- ◆ Maintenance
- ◆ Home / Farm / Shop



PROTIG NG S & III S TORCHES

PROTIG NG S

The ergonomic handle with button (EB).

The best WELDLINE torches with an advanced ergo-design, using a colored soft grip for a maximum welder comfort. These torches will give you an optimum welding quality, and increase the communication between the welder and the machine.

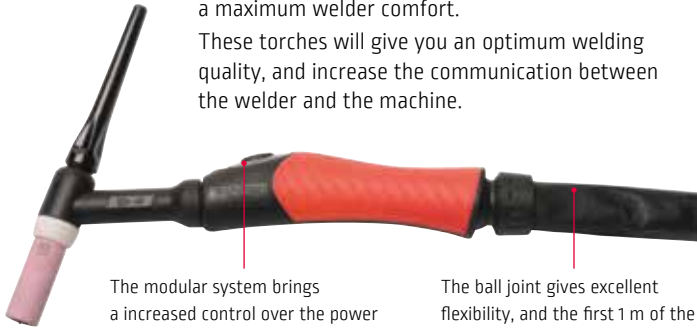

The modular system brings a increased control over the power source. All torches are delivered with a single button module.

The ball joint gives excellent flexibility, and the first 1 m of the harness is leather which increases the service life of the welding hose.

PROTIG III S

The round handle with a blade trigger (RL).

These classic round handled TIG torches have been designed to meet all welding expectations in all positions. The trigger module is fully adjustable and can be moved to any position around the handle.

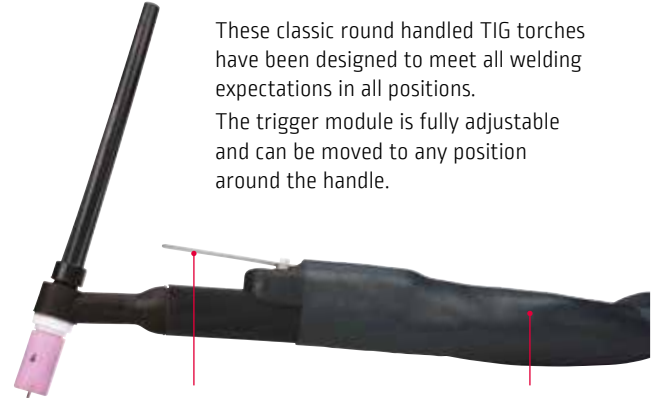

New design of the trigger module with metal blade.

The woven sheath and the handle sleeve ensure full flexibility of the harness.

Air cooled

MODEL		PROTIG 10		PROTIG 20		PROTIG 30		PROTIG 40		
Duty cycle 35%		125 A		150 A		200 A		250 A		
Duty cycle 60%		80 A		100 A		130 A		200 A		
Fitted as standard	back cap	Long								
	nozzle	Ø 9.6 mm				Ø 12 mm				
	electrode	Ø 1.6 mm		Ø 2.0 mm		Ø 2.4 mm				
Length		5 m	8 m	5 m	8 m	5 m	8 m	5 m	8 m	
PROTIG III S	Connection	C5B/S	W000382715-2	W000382716-2	W000382717-2	W000382718-2	W000382719-2	W000382720-2	W000382721-2	W000382722-2
PROTIG NG S			W000278394-2	W000278395-2	W000278396-2	W000278397-2	W000278398-2	W000278399-2	W000278400-2	W000278401-2

Water cooled (*)

MODEL		PROTIG 10W		PROTIG 35W		PROTIG 40W		
Duty cycle 100%		220 A		350 A		450 A		
Fitted as standard	back cap	long						
	nozzle	Ø 12.8 mm		Ø 15 mm		Ø 14 mm		
	electrode	Ø 2.4 mm		Ø 4.0 mm		Ø 4.8 mm		
Length		5 m	8 m	5 m	8 m	5 m	8 m	
PROTIG III S	Connection	C5B/S	W000382723-2	W000382724-2	W000382725-2	W000382726-2	W000382727-2	-
PROTIG NG S			W000278402-2	W000278403-2	W000278404-2	W000278405-2	W000278406-2	W000278407-2

⚠ (*) Plug kit WP10529-5 is needed for the following machines: Citotig II DC range, Prestotig II DC range, Prestotig/Citotig 240-310 AC/DC range, Prestotig/Citotig 350W.

Connectors, adapters

Connectors

The connectors to the machine are a new design, compact and fully protected delivering both strength and quality. All hoses are rubber with a woven sheath for heavy duty work.

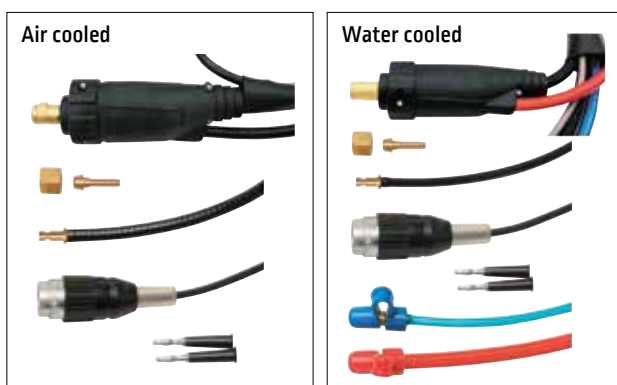

Adapters

For old torches with central gas to be connected to power sources with separate gas, use **W000306140**.

For torches with separate gas to be connected to power sources with central gas, use **W000306141**.

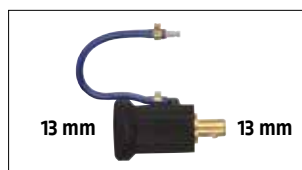

Dinse 9 to 13 mm
W000306139

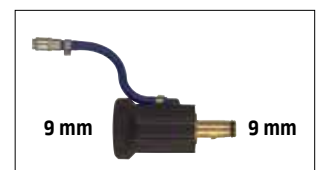

Dinse 13 to 9 mm
038055011



OPTIONS ON PROTIG NG S

Adjustable heads

As an option, adjustable torch bodies are available, designed to make welding in limited access locations easier with a choice of 2 heads, small and large which are mounted on air cooled or water cooled bodies.



Modular system:

Standard delivery for EB all torches is a single button module. Other control module formats are available to order.

Single button delivery



Other buttons



Horizontal potmeter

W000279370
[4.7 Kohm]

WP10529-3
[10 Kohm]



Vertical potmeter

W000279246
[4.7 Kohm]

WP10529-4
[10 Kohm]



3 buttons module

WP10529-2



Blade













W000279245

Choose one body and one head to get a complete torch.

- Air cooled body (10/20) W000279381
- Water cooled body (10W) W000279382
- Head PROTIG NG 10/10W W000279383
- Head PROTIG NG 20 W000279384

⚠ Plug kits are needed in addition to the button modules: see below table

Choose your module & your plug kit for Protig NG S

Button modules		 or 	 or 	 or 	 or 
Reference	WP10529-2	W000279246 [4.7 Kohm] or W000279370 [4.7 Kohm]	W000279246 [4.7 Kohm] or W000279370 [4.7 Kohm]	W000279246 [4.7 Kohm] or W000279370 [4.7 Kohm]	WP10529-4 [10 Kohm] or WP10529-3 [10 Kohm]
Plug kit	· No plug kit needed · Torch is connected to the machine through the C5B plug (5 pins)	+  WP10529-6	+  WP10529-7	+  WP10529-8	+  WP10529-9
Work with	· Invertec 220/300/400 TPX · Aspect 200 · Prestotig 200 AC/DC · Prestotig 315/415 DC · Citotig 200 AC/DC · Citotig 315/415 DC	· Prestotig 210 DC · Prestotig 310 DC · Prestotig 410 DC · Prestotig 240 AC/DC · Prestotig 310 AC/DC	· Prestotig 210 AC/DC · Prestotig 250 AC/DC · Prestotig 350 AC/DC	· Saxotech 170/220 · Saxotig 160 AC/DC · Prestotig 180/220 Pro · Prestotig 180/220 Force	· All Lincoln machines with pedal control · Prestotig 315/415 DC · Prestotig 315 AC/DC · Citotig 315/415 DC · Citotig 315 AC/DC

The above modules work only with the PROTIG NG S torches (EB handle).

Remark for users of Prestotig/Citotig II DC, 240/310 AC/DC & 350W in water cooled configuration: plug kit p/n WP10529-5 must be adopted while using TIG torches with single button.

WEAR PARTS

PROTIG 10 / 10W

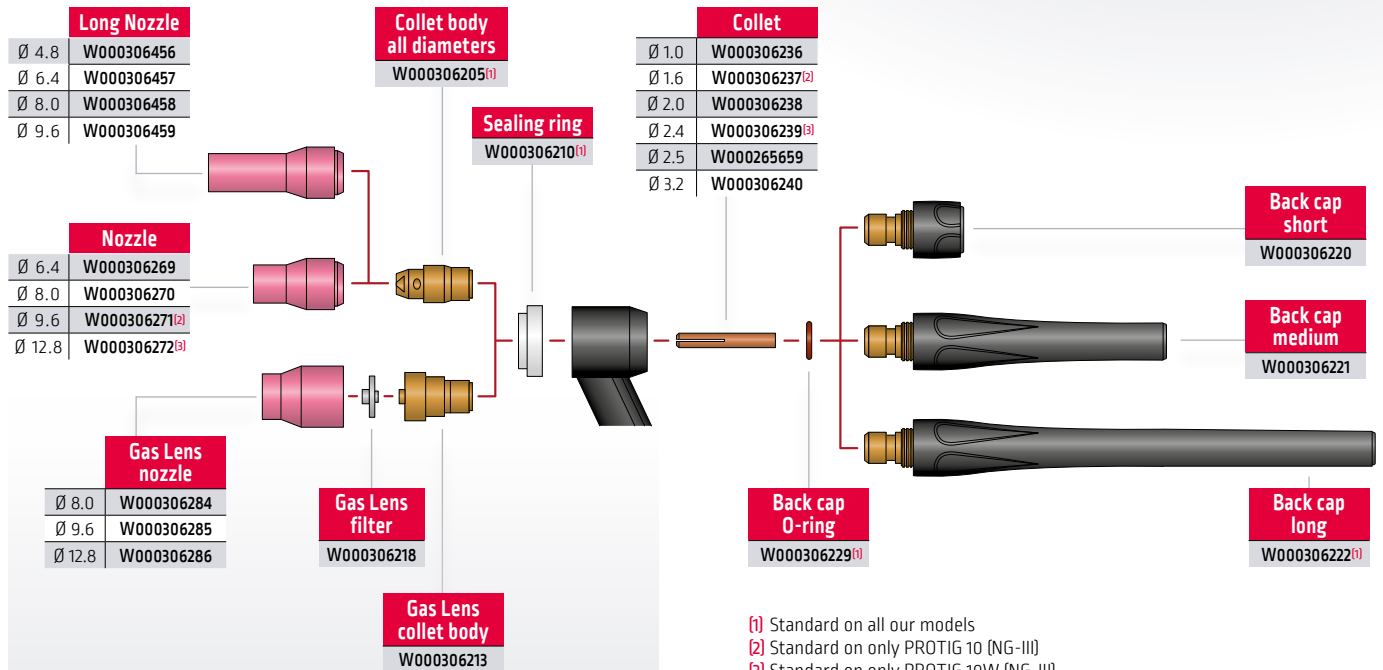

Gas lens, for welding where access is difficult.

The gas lens collet body is supplied with a filter and a sealing ring. The ring and the filter are supplied on their own.

Nozzles : choice of diameter

Welding current (A)	70	90	120	200
Diameter (mm)	6	8	10	12

Wear part box PROTIG 10 / 10W for convenient storage

A complete kit for all applications.

The kit includes electrode collets, nozzles, back caps and collet body.



To order W000306441

SHORT BACK CAP M8

MEDIUM BACK CAP M8

LONG BACK CAP M8

COLLET BODY PROTIG 10

1.0 mm

1.6 mm

2.0 mm

2.4 mm

3.2 mm

6.4 mm

8.0 mm

9.6 mm

12.8 mm

COLLET
PROTIG 10

STD NOZZLE

Extension cables

Extenders have a length of 15 m. They are equipped with power connectors, C5B plug (5 pins) and «banana» plugs. The connection is protected by a leather envelope with Velcro® fastener.

To order

EXTENSION AIR 15M

W000306135

EXTENSION WATER 15M

W000306136



WEAR PARTS

PROTIG 20

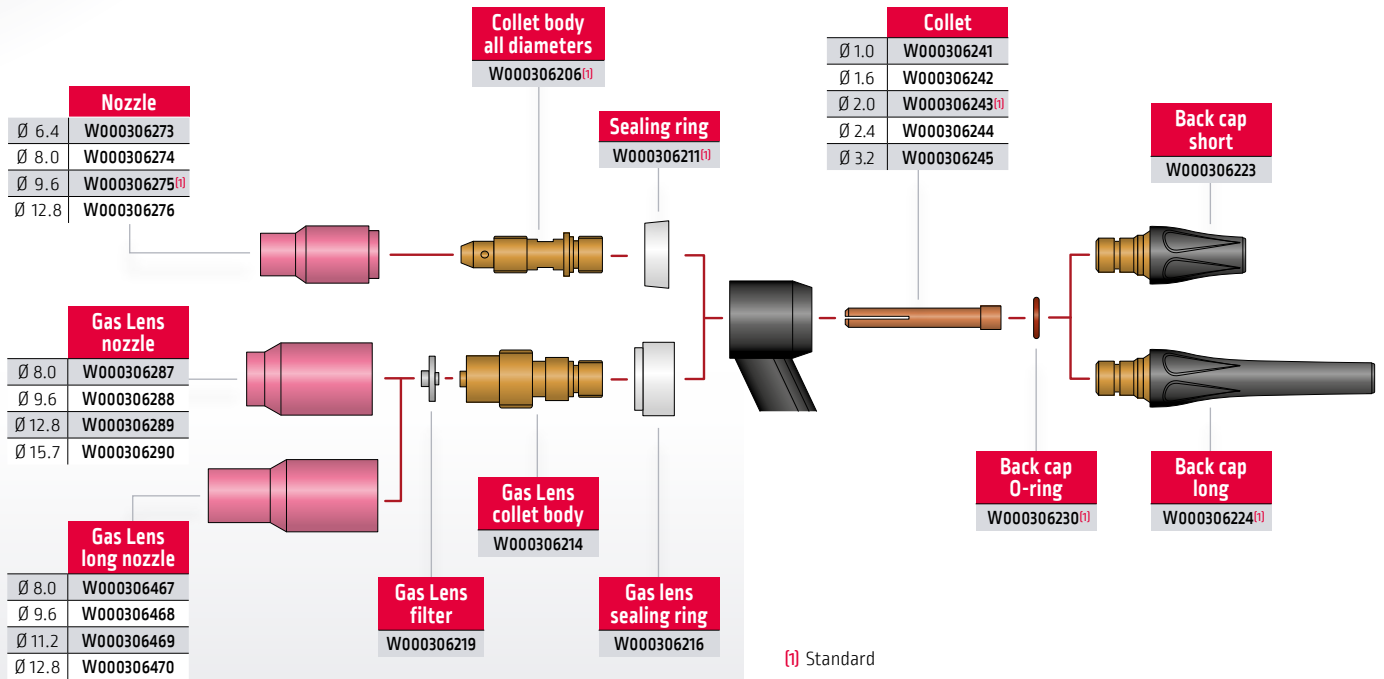

⁽¹⁾ Standard

Gas lens, for welding where access is difficult.

The gas lens collet body is supplied with a filter and a sealing ring. The ring or the filter are supplied on their own.

Nozzles : choice of diameter

Welding current (A)	70	90	120	200	350
Diameter (mm)	6	8	10	12	15

Wear part box PROTIG 20 for convenient storage

A complete kit for all applications.

The kit includes electrode collets, nozzles, back caps and collet body.



To order	W000306442
SHORT BACK CAP M10	
LONG BACK CAP M10	
COLLET BODY PROTIG 20	
	1.0 mm
	1.6 mm
COLLET PROTIG 20	2.0 mm
	2.4 mm
	3.2 mm
	6.4 mm
STD NOZZLE	8.0 mm
	9.6 mm
	12.8 mm

Extension cables

are available for all torch model in the brochure



WEAR PARTS

PROTIG 30

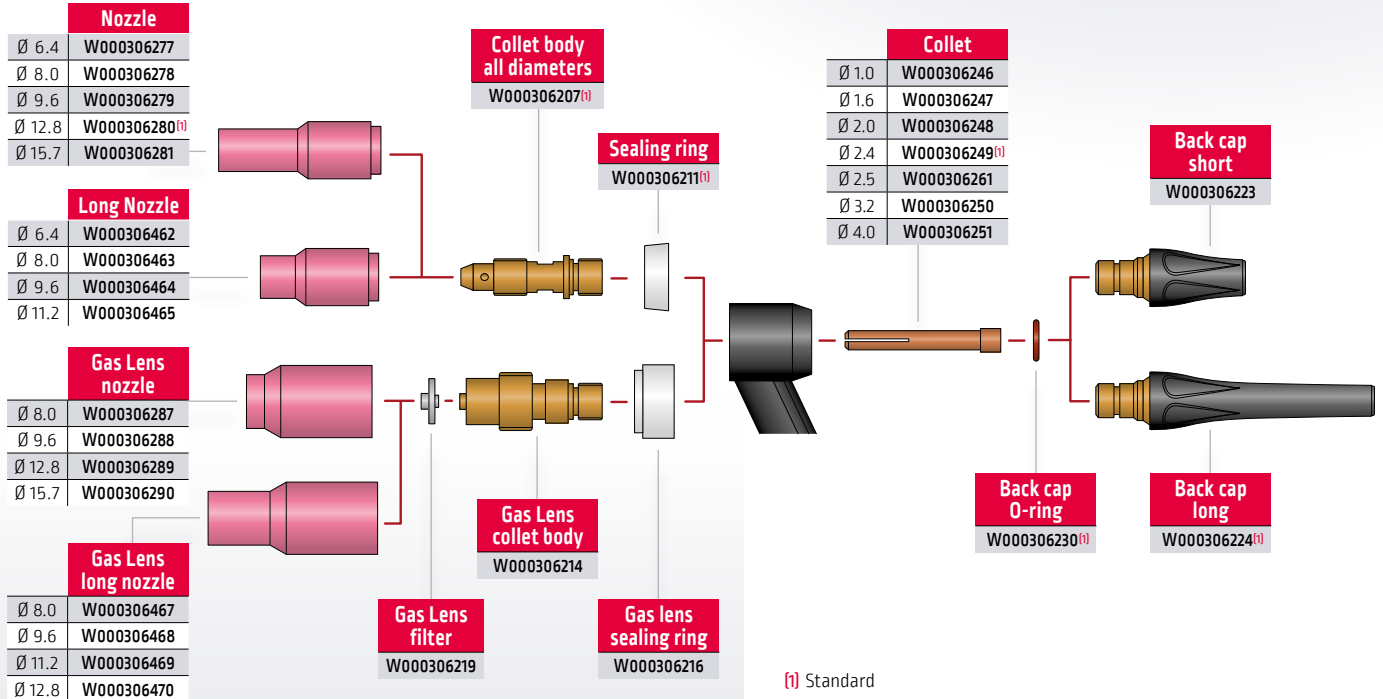

⁽¹⁾ Standard

Gas lens, for welding where access is difficult.

The gas lens collet body is supplied with a filter and a sealing ring. The ring or the filter are supplied on their own.

Nozzles : choice of diameter

Welding current (A)	70	90	120	200	350
Diameter (mm)	6	8	10	12	15

Wear part box PROTIG 30 for convenient storage



A complete kit for all applications.

The kit includes electrode collets, nozzles, back caps and collet body.



To order W000306443

SHORT BACK CAP M10	
LONG BACK CAP M10	
COLLET BODY PROTIG 30	
COLLET PROTIG 30	1.0 mm
	1.6 mm
	2.0 mm
	2.4 mm
	3.2 mm
	4.0 mm
STD NOZZLE	6.4 mm
	8.0 mm
	9.6 mm
	12.8 mm
	15.7 mm

Extension cables

are available for all torch model in the brochure

WEAR PARTS

PROTIG 35W / 40

Nozzle	
Ø 6.4	W000306277
Ø 8.0	W000306278
Ø 9.6	W000306279
Ø 12.8	W000306280 ⁽²⁾
Ø 15.7	W000306281 ⁽³⁾

Long Nozzle	
Ø 6.4	W000306462
Ø 8.0	W000306463
Ø 9.6	W000306464
Ø 11.2	W000306465

Gas Lens nozzle	
Ø 8.0	W000306287
Ø 9.6	W000306288
Ø 12.8	W000306289
Ø 15.7	W000306290

Gas Lens long nozzle	
Ø 8.0	W000306467
Ø 9.6	W000306468
Ø 11.2	W000306469
Ø 12.8	W000306470

Collet body all diameters	
W000306208 ⁽¹⁾	

Collet body heavy duty*	
W000306201	

Sealing ring	
W000306212 ⁽¹⁾	

Gas Lens filter	
W000306219	

Gas Lens collet body	
W000306215	

Gas lens sealing ring	
W000306217	

Collet	
Ø 1.0	W000306252
Ø 1.6	W000306253
Ø 2.0	W000306254
Ø 2.4	W000306255 ⁽²⁾
Ø 3.2	W000306256 ⁽³⁾
Ø 4.0	W000306257

Back cap short	
W000306225	

Back cap O-ring	
W000306231 ⁽¹⁾	

Back cap long	
W000306226 ⁽¹⁾	

(1) Standard on all our models
 (2) Standard on only PROTIG 40 (NG-III)
 (3) Standard on only PROTIG 35W (NG-III)

* For the collet body « heavy duty », use the gas lens nozzles or the gas lens long nozzles

Gas lens, for welding where access is difficult.

The gas lens collet body is supplied with a filter and a sealing ring. The ring or the filter are supplied on their own.

Nozzles : choice of diameter

Welding current (A)	70	90	120	200	350
Diameter (mm)	6	8	10	12	15

Wear part box PROTIG 35W / 40 for convenient storage

A complete kit for all applications. The kit includes electrode collets, nozzles, back caps and collet body.



To order	W000306444
SHORT BACK CAP PROTIG 40	
LONG BACK CAP PROTIG 40	
BACK CAP O-RING (X 2)	
COLLET BODY	
1.6 mm	
2.0 mm	
2.4 mm	
3.2 mm	
4.0 mm	
6.4 mm	
8.0 mm	
9.6 mm	
12.8 mm	
15.7 mm	
COLLET PROTIG 40	
STD NOZZLE	
6.4 mm	
8.0 mm	
9.6 mm	
12.8 mm	
15.7 mm	

Extension cables are available for all torch model in the brochure



WEAR PARTS

PROTIG 40W

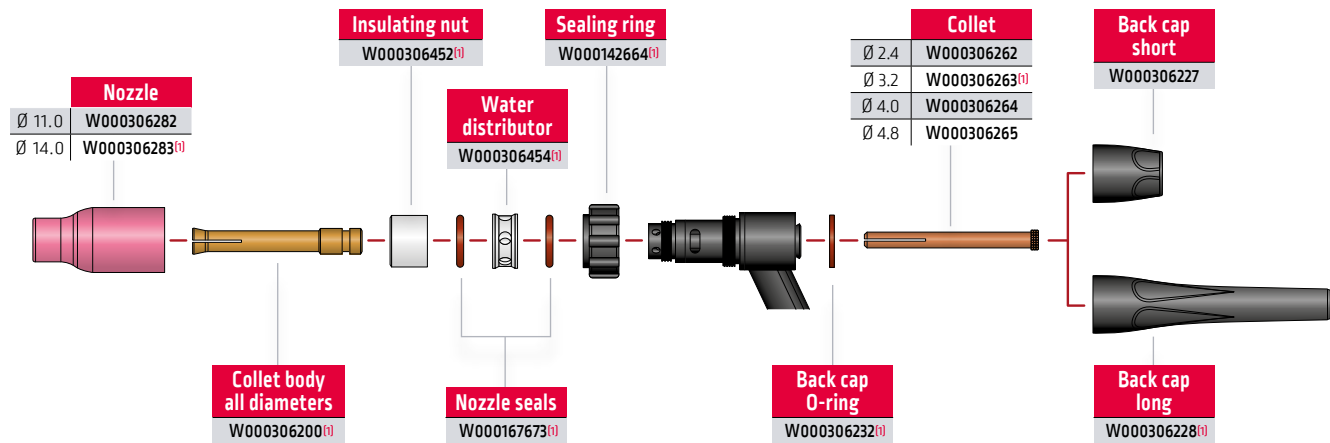

Nozzles : choice of diameter

Welding current (A)	200	450
Diameter (mm)	11	14

⁽¹⁾ Standard

Wear part box PROTIG 40W for convenient storage

A complete kit for all applications. The kit includes electrode collets, nozzles, back caps and collet body.

Extension cables

are available for all torch model in the brochure



To order	W000306445
SHORT BACK CAP P40W	
LONG BACK CAP P40W	
	2.4 mm
	3.2 mm
COLLET P40W	4.0 mm
	4.8 mm
BACK CAP O-RING P40W	
ELASTIC RING P40W	
COLLET BODY P40W	
NOZZLE SEALS (X 2)	
WATER DISTRIBUTOR P40W	
INSULATING NUT P40W	
NOZZLE	11.0 mm
	14.0 mm



TUNGSTEN ELECTRODES

A complete range of tungsten electrodes:

- Pure tungsten,
- Tungsten + cerium,
- ■ Tungsten + lanthanum,
- ■ Tungsten + rare earths ⁽¹⁾.

Product advantages :

- ◆ Very high life cycle
- ◆ Very stable arc
- ◆ Perfect arc ignition
- ◆ Tip longevity



Choice criteria

Type	Metal		Arc stability	Striking	Lasting	Thermal resistance
	Aluminium	Steel & Stainless steel				
WP - Pure tungsten	*		**	*	*	*
WCe 20 - Cerium 2%		*	**	*	**	**
WLa 15 - Lanthanum 1,5%	**	***	**	***	***	***
WLa 20 - Lanthanum 2%	*	***	**	***	***	***
WS 2 - Rare earths ⁽¹⁾ 2%	*	*	**	***	***	***

CAUTION:
before use, carefully read and understand the safety datasheet available on our websites

*** Excellent - ** Good - * Average

⁽¹⁾ Rare earths = any of the abundant metallic elements, including scandium (atomic number 21), yttrium (39), and the 15 elements from 57 to 71 (lanthanide series include lanthanum and cerium) in the Mendeleev classification.



Highest lifetime,
Higher current density,
Less grinding, Faster starts
and better arc stability

Nertal WP	
Ø mm	150 mm length To order
1.0	S03710250
1.6	S03710251
2.0	S03710252
2.4	S03710506
2.5	S03710268
3.2	S03710507
4.0	S03710254
4.8	S03710510
6.0	S03710256

Nertal La 20	
Ø mm	150 mm length To order
1.6	S03710651
2.0	S03710652
2.4	S03710653
3.2	S03710655
4.0	S03710656
4.8	W000381291

Nertal Ce 20	
Ø mm	150 mm length To order
1.0	S03710530
1.6	S03710531
2.0	S03710533
2.4	S03710534
3.2	S03710537
4.0	S03710538
4.8	S03710539

WP - Pure tungsten Light alloy (green tip)		
Ø mm	150 mm length	175 mm length
To order		
1.0	W000010009	-
1.6	W000010010	W000010375
2.0	W000010011	W000010376
2.4	W000010012	W000010377
3.0	W000010013	-
3.2	W000010014	W000010378
4.0	W000010015	W000335152

WLa 20 - Lanthanum 2% Light alloy (using AC current), steel and stainless steel (using DC current) (blue tip)			
Ø mm	75 mm length	150 mm length	175 mm length
To order			
1.0	W000011144	W000010373	-
1.6	W000011145	W000010016	W000010385
2.0	-	W000010017	W000010386
2.4	W000011146	W000010018	W000010387
3.0	-	W000010019	-
3.2	-	W000010020	W000010388
4.0	-	W000010021	W000010389

WCe 20 - Cerium 2% Steel and stainless steel (grey tip)		
Ø mm	150 mm length	175 mm length
To order		
1.0	W000010022	-
1.6	W000010023	W000335153
2.0	W000010024	W000010381
2.4	W000010025	W000335154
3.0	W000010026	-
3.2	W000335150	W000335157
4.0	W000010028	W000335155

WS 2 - Rare earths 2% Light alloy (using AC current), steel and stainless steel (using DC current) (turquoise tip)	
Ø mm	175 mm length To order
1.0	W000335166
1.6	W000335167
2.0	W000335168
2.4	W000335169
3.0	W000335170
3.2	W000335171
4.0	W000335172

WLa 15 - Lanthanum 1.5% Light alloy (using AC current), steel and stainless steel (using DC current) (gold tip)	
Ø mm	150 mm length To order
1.0	W000402632
1.6	W000402663
2.0	W000402664
2.4	W000402665
3.0	W000402666
3.2	W000402667
4.0	W000402668

BEING PRESENT LOCALLY MAKES US MORE AWARE GLOBALLY



125
YEARS OF EXPERIENCE

325+
GLOBAL R&D TEAM

3.0
BILLION USD REVENUE

38
SOLUTION
CENTERS

11 000
EMPLOYEES WORLDWIDE

-  Global Headquarters
-  Solution Centers

CUSTOMER ASSISTANCE POLICY

The business of The Lincoln Electric Company® is manufacturing and selling high quality welding equipment, consumables, and cutting equipment. Our challenge is to meet the needs of our customers and to exceed their expectations. On occasion, purchasers may ask Lincoln Electric for information or advice about their use of our products. Our employees respond to enquiries to the best of their ability based on information provided to them by the customers and the knowledge they may have concerning the application. Our employees, however, are not in a position to verify the information provided or to evaluate the engineering requirements for the particular weldment. Accordingly, Lincoln Electric does not warrant or guarantee or assume any liability with respect to such information or advice. Moreover, the provision of such information or advice does not create, expand, or alter any warranty on our products. Any express or implied warranty that might arise from the information or advice, including any implied warranty of merchantability or any warranty of fitness for any customers' particular purpose is specifically disclaimed.

Lincoln Electric is a responsive manufacturer, but the selection and use of specific products sold by Lincoln Electric is solely within the control of, and remains the sole responsibility of the customer. Many variables beyond the control of Lincoln Electric affect the results obtained in applying these types of fabrication methods and service requirements.

Subject to Change – This information is accurate to the best of our knowledge at the time of printing. Please refer to www.lincolnelectric.eu for any updated information.



www.lincolnelectriceurope.com

