

**Model 763 DataSmart
Programmable Fully Automatic Manifold w/Telemetry**

Installation & Operation manual

CONTENTS

| | |
|---|--------------|
| Safety Guidelines..... | 3 |
| User Responsibility..... | 4 |
| Introduction To The Model 763 DataSmart Gas Distrubution System..... | 5 |
| Features..... | 5 |
| Check Back Feature..... | 6 |
| Economizer Function | 6 |
| Installation Instructions..... | 6 |
| Reference Material..... | 7 |
| Preparing For DataSmart..... | 7 |
| General Installation Guidelines..... | 8 |
| Mounting Instructions..... | 8 |
| Attaching Cylinders..... | 9 |
| For A Two Cylinder Manifold..... | 9 |
| Manifold For More Than Two Cylinders..... | 11 |
| Pressurizing The DataSmart Manifold System..... | 12 |
| DataSmart Operation Instructions..... | 12 |
| Connecting To Power..... | 12 |
| DataSmart Initial Setup (Username/Password, Machine Name, Configure Wifi, Registration Code, Telemetry Configuration, User Selectable Features, System Parameters, User Selectable Features..... | 13-17 |
| DataSmart Production Analytics..... | 17 |
| Appendix A – Cloud-Based Architectur/Security and Data Storage..... | 18 |
| Appendix B – DataSmart Wiring Diagram..... | 19 |
| Appendix C – Troubleshooting Guide..... | 20 |
| Appendix D – Piping and Instrumentation (P&ID) Diagram..... | 21 |
| Appendix E – DataSmart Model 763 GUI Instructions..... | 22 |

SAFETY GUIDELINES

Basic safety precautions must be followed to reduce the risk of fire, electrical shock or injury.

- Connect the DataSmart to the correct line voltage. A label on the product identifies what voltage it is wired for. CONNECTION TO AN INCORRECT VOLTAGE CAN CAUSE SERIOUS DAMAGE TO THE PRODUCT AND WILL VOID ANY WARRANTY.
- Install the DataSmart where the ambient temperature range is between - 0° F and +120° F.
- DataSmart NEMA enclosures and controls are intrinsically safe and can be used to control and regulate certain flammable gases such as hydrogen, ethylene, methane and propane (LP Gases). In addition, DataSmart can be used in Class 1, Division 2, Groups B and D environments where ambient explosive gases or mixtures are not expected to be present in normal operation.
- DataSmart cannot be used for acetylene gas service. Do not install this product in a Class 1, Division 1, (Group A, B, C or D) environment where ambient explosive gases or mixtures are expected to be present in normal operation.
- If product appears damaged in any way, do not use and contact Harris Products Group Technical Service.
- Consult the cylinder distributor for the proper use of cylinders and for any restrictions on their use (such as flow rate and temperature requirements).
- Store cylinders with valve caps screwed on, and chain cylinders to a supporting wall or column. • Handle cylinders carefully and only with valve caps screwed on. The cap will reduce the chance that the cylinder valve will break off if the cylinder is accidentally dropped or falls over. The cap also protects the cylinder valve from damage to screw threads, which could cause leaky connections.
- No smoking should be permitted near oxygen, nitrous oxide, any other oxidizer, flammable gases, or flammable mixtures, or in areas where cylinders are stored.
- Where an oxidizer (such as nitrous oxide or oxygen) is used, the manifold and cylinders must be kept clean. No oil, grease, or combustible substances should come in contact with oxygen or nitrous oxide storage or handling equipment. Such materials in contact with oxygen or nitrous oxide are readily ignitable and, when ignited, will burn intensely.
- Never lift gas cylinders with a magnetic lifting device.
- Never use an open flame when leak testing.
- Always open valves slowly when high-pressure gases are being used.
- Always be sure that a cylinder contains the correct gas before connecting it to any manifold.
- Always leak-test any manifold or distribution pipeline before using.
- Always be sure that the gas in a pipeline is the correct gas for the intended use.
- Always close all cylinder valves before disconnecting cylinders from a manifold.
- Always remove all empty cylinders from a manifold before connecting full cylinders.

• Always test cylinders to be sure the cylinders are full before connecting to a manifold. All gas distribution piping systems must meet the appropriate industrial standards for the intended service and must be thoroughly cleaned before using. For the United States, some applicable safety rules and precautions are listed below:

1. American National Standards Institute standard Z49.1, Safety in Welding and Cutting, American Welding Society, 2501 NW Seventh Street, Miami, Florida 33125
2. N.F.P.A. Standard 51, Oxygen-Fuel Gas systems for Welding and Cutting, N.F.P.A., 470 Atlantic Avenue, Boston, Massachusetts 02210
3. N.F.P.A. Standard 51B, Cutting and Welding Processes (same address as #2).
4. Local Ordinances
5. O.S.H.A. Standard 29 CFR
6. C.G.A. Pamphlet C-4, American National Standard Method of Marking Portable Compressed Gas Containers to Identify the Material Contained.
7. C.G.A. Pamphlet G-4, Oxygen – Information on the properties, manufacture, transportation, storage, handling, and use of oxygen.
8. C.G.A. Pamphlet G-4.1, Equipment Cleaned for oxygen service.
9. C.G.A. Pamphlet G-4.4, Industrial Practices for Gaseous Oxygen Transmission and Distribution Piping Systems. 10. C.G.A. Pamphlet G-5, Hydrogen – Information on the properties, manufacture, transportation, storage, handling, and use of hydrogen.
11. C.G.A. Pamphlet G-6, Carbon Dioxide – Information on the properties, manufacture, transportation, storage, handling, and use of carbon dioxide.
12. C.G.A. Pamphlet G-6.1, Standard for Low Pressure Carbon Dioxide Systems at Consumer Sites.
13. C.G.A. Pamphlet P-1, Safe Handling of Compressed Gases in Containers. 15. C.G.A. Safety Bulletin SB-2, Oxygen Deficient Atmospheres. C.G.A. Pamphlets can be obtained from the Compressed Gas Association, 3

USER RESPONSIBILITY

Service to this product should only be performed by HARRIS PRODUCTS GROUP.. Requests for service may be made through HARRIS CUSTOMER SERVICE. HARRIS accepts no responsibility for damage or injury if this product is modified in any way. HARRIS assumes/accepts no liability or responsibility for damage to individuals or equipment that may occur when using this product.

INTRODUCTION TO THE MODEL 763 DATASmart GAS DISTRIBUTION SYSTEM

The Model 763 DataSmart manifold is a gas distribution system used to monitor, control and switch the flow of gas from bulk, cryogenic or high pressure cylinders while maintaining a settable, constant delivery pressure to the facility or process. It consists of an electronically controlled switchover valve that can be programmed to switch over at two independent pressures depending on the input source. The manifold offers two stage pressure control to the downstream pipeline assuring precise delivery pressure control.

Input pressures are monitored on both the right and left side by a local LCD touchscreen display. The display also indicates the gas source as either a high pressure cylinder, a liquid dewar or a bulk gas source (bulk tank or cylinder packs). The outlet pressure of the system is also monitored and displayed on the LCD screen. Outlet pressure adjustment is available using an adjusting screw on the delivery regulator from an access port on the outside of the Mechanical Enclosure.

A series of indicator lights and messages on the LCD screen show the status of the system at any given time. System status can also be monitored remotely via a built-in, wifi based telemetry system that sends and retrieves data from a remote server to the user's computer or mobile device. This integrated telemetry system also has the capability to send messages and alerts via email or SMS. Remote monitoring is a subscription based service that is available from The Harris Products Group.

FEATURES

- Designed to connect to multiple gas sources: High pressure cylinders, liquid dewars, cylinder packs or bulk gas systems
- Capable of operating with inlet pressure provided by 230, 350, and 500 PSI liquid cylinders, 3,000 PSI high pressure cylinders, or any combination.
- Check Back Feature for liquid dewars
- Economizer for reserve side liquid dewars
- Programmable switchover pressure for both right and left side from 70 to 2000 psig
- LCD Touchscreen control
- Secure login to protect settings
- Built-in, Wifi-based telemetry system and data acquisition via a remote server (connection to a Wifi network required)
- Customized alerts and notifications via email and SMS
- Optional mass flow meter to measure current gas usage or usage over time
- Class 1, Division 2 NEMA Enclosures
- Optional Remote A/V Alarm
- Modular, expandable header system for multiple cylinders
- Output pressures up to 450 psi available
- Integral 500 scfh heaters for CO₂, N₂O or mixtures
- Configurable flex hoses up to 120" available
- Designed for high purity or industrial grade gases
- Brass models designed for high flows up to 3000 scfh
- Brass and SS models available

CHECK BACK FEATURE

When using liquid cylinders, it is not uncommon for the primary side pressure to drop below the switchover point even if there is still a significant amount of gas left in the cylinder. This could be caused by an increase in downstream demand during peak gas usage, or, when the liquid volume in the cylinder becomes low. As a result, manifold systems without a Check Back feature may do one of two things –

1. Switch to the reserve side until the pressure builds back up and then switch back to the former primary side. This will happen repeatedly resulting in both sides of the manifold being depleted at the same time, or,
2. Switch to the reserve side permanently resulting in a significant amount of gas left in the cylinder unused.

To avoid either of these situations, the Model 763 DataSmart manifold has an electronically controlled Check Back feature that performs as follows:

- a) If the primary side pressure goes down below the switchover point, the system temporarily switches over to the reserve side. The system does not go into alarm mode at this point and the system status does not change.
- b) The LCD screen indicates “Check Back” mode.
- c) After 30 minutes, the system checks back to see if reserve side pressure has recovered to 15% or more above the switchover point
- d) If so, the system switches back and uses gas until the switchover pressure is reached
- e) If not, the system goes into alarm mode and shows empty
- f) The DataSmart system will perform steps a, b and c three times. After that, the system goes into alarm mode and switches over to the reserve side. System status lights will change at this time.
- g) After the system goes into alarm mode, any increase in pressure 15% above the switchover point on the empty side resets the check back feature and assumes the empty cylinder has been replaced.

ECONOMIZER FUNCTION

Liquid cylinders that are in reserve with no gas being used will continue to build head pressure until the relief valve opens venting gas to the atmosphere where it is lost and cannot be used. The Model 763 DataSmart is constantly sensing pressure being built up on the reserve side. If the reserve side pressure builds up to within 85% of the relief valve setting, the system will switch over to the reserve side for 5 minutes to use gas and lower the building head pressure before the relief valve activates. The DataSmart system will continue to sense increasing pressure on the reserve side and activate in 5 minute intervals so long as a liquid dewar is installed on the reserve side. This is also indicated on the LCD screen as a function of the “Check Back” feature.

INSTALLATION INSTRUCTIONS

Caution

Read and understand installation instructions thoroughly prior to using this system. If you have any questions about the installation, contact Harris Technical Service (800-241-0804, Option 2) for assistance.

WARNING

It is important that when installing this manifold system that no oil or contaminants come in contact with any manifold parts. If parts have been contaminated during shipment, **do not use** and contact Harris Technical Service (800-241-0804, Option 2) for assistance.

REFERENCE MATERIAL

The following safety bulletins/standards are available on the Compressed Gas Association's website (www.cganet.com) or at (703) 412-0900:

- SB-2 Oxygen Deficient Atmospheres
- SB-10 Correct Labeling & Proper Fittings On Cylinders/Containers
- SB-15 Avoiding Hazards In Confined Work Spaces During Maintenance, Construction And Similar Activities
- SB-19 Potential Valve Thread & Cylinder Thread Mismatch
- E-11 Compressed Gas Association Standard for Cylinder Discharging Manifolds for Pressures Up To 3000 PSI

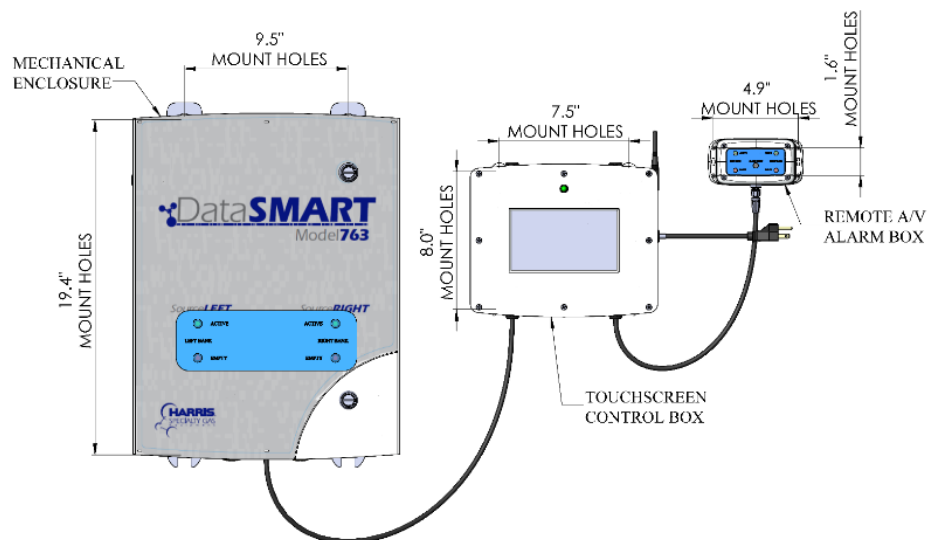

Figure 1 – Mounting Dimensions

The above Figure 1 shows a typical installation with critical mounting dimensions. The Touchscreen Control Box can be mounted in close proximity to the Mechanical Enclosure. The Remote A/V Alarm Box can be mounted up to 200 feet away with the proper cable. Contact Harris Technical Service for more information.

Preparing for DataSmart

To use DataSmart, basic requirements must be met. You need an internet connection to transmit data frames to the DataSmart server. To provide access to the Internet, you must connect to a wireless access point with Internet access. DataSmart analysis and subscription services require access to the internet to transmit data to the DataSmart data server in the cloud. The DataSmart data server <https://ams.harrisproductsgroup.com> is located at IP address 207.89.49.159. Opening port 443 outbound only in your network firewall allows each DataSmart to send data via HTTPS. Contact your local IT department for assistance in connecting DataSmart machines to the internet and firewall configuration.

GENERAL INSTALLATION GUIDELINES

1. Installation should be performed by personnel knowledgeable in the handling of compressed gases and familiar with compressed gas equipment.
2. Choose a location well ventilated for installation.
3. Use proper precautions when dealing with any compressed gas.
4. The user should be familiar with the chemical and reactive properties of the gas being used (Read the MSDS of the gas being used).
5. The DataSmart gas distribution system requires connection to the internet via a Wifi network in order to logon, register and set up the system. If connection to a Wifi network is not possible, the use of a Mifi or Personal Hotspot may be necessary to complete installation of this system.
6. Install the DataSmart where the ambient temperature range is between 0° F and +120° F.
7. Do not install this product in a hazardous environment. The DataSmart Mechanical Enclosure and Touchscreen Control Box are designed with a Class 1, Division 2 NEMA enclosure and can be used for certain flammable gases. However, the system must be installed in a well ventilated location.
8. If product appears damaged in any way, do not use and contact The Harris Products Group Technical Service.

MOUNTING INSTRUCTIONS

1. The Mechanical Enclosure should be mounted to a rigid structure capable of supporting 100+ lbs. Do not attempt to mount to a sheet rock wall or similar surface without the use of properly installed mounting channel or railing.
2. Mount the Mechanical Enclosure at a height that is easily accessible to the user so that the outlet regulator can be adjusted as necessary and the access door can be opened, if required.
3. Locate the mounting tabs on the Mechanical Enclosure and the mounting dimensions from Figure 1.
4. Secure the Mechanical Enclosure using the mounting brackets at the top and bottom of the enclosure. Mounting hardware is not included.
5. Once the Mechanical Enclosure is secured, mount the Touchscreen Control Box in a similar manner at a height no more than eye level so that screen information can easily be seen and modifications to the set up can be made. The Touchscreen Control Box should be mounted in close proximity to the Mechanical Enclosure (the standard connection cable is 10 ft.), or, with a longer cable, this box can be mounted up to 100 ft away.
6. Mount the A/V Remote Alarm Box (if supplied), in a similar manner to the Touchscreen Control Box. Mount at a height accessible so that the alarm shut-off can be activated. The A/V Remote Alarm box can be mounted up to 200 ft. away with proper cable. The standard cable

supplied is 10 ft.

ATTACHING CYLINDERS

The below safety guidelines should always be followed when handling compressed gas cylinders.

1. Handle cylinders carefully and only with valve caps screwed on. The cap will reduce the chance that the cylinder valve will break off if the cylinder is accidentally dropped or falls over. The cap also protects the cylinder valve from damage, which could cause leaky connections.
2. No smoking should be permitted near oxygen, nitrous oxide, any other oxidizer, flammable gases, or flammable mixtures, or in areas where cylinders are stored.
3. Where an oxidizer (such as nitrous oxide or oxygen) is used, the manifold and cylinders must be kept clean. No oil, grease, or combustible substances should come in contact with oxygen or nitrous oxide storage or handling equipment. Such materials in contact with oxygen or nitrous oxide are readily ignitable and, when ignited, will burn intensely.
4. Never lift gas cylinders with a magnetic lifting device.
5. Never use an open flame when leak testing.
6. Always open valves S-L-O-W-L-Y when high-pressure gases are being used.
7. Always be sure that a cylinder contains the correct gas before connecting it to any manifold.
8. Always leak-test any manifold or distribution pipeline before using.
9. Always be sure that the gas in a pipeline is the correct gas for the intended use.
10. Always close all cylinder valves before disconnecting cylinders from a manifold.
11. Always remove all empty cylinders from a manifold before connecting full cylinders.
12. Always test cylinders to be sure the cylinders are full before connecting to a manifold.

For a two cylinder manifold –

1. Attach the flexible hoses (pigtailed) to the right and left side inlet connections on the Mechanical Enclosure as shown in Figure 2. The manifold inlets are located at the bottom of the Mechanical Enclosure.
2. One end of the flex hose (pigtail) will connect directly to the Mechanical Enclosure and should be wrench tight using Teflon tape as a thread sealant. The other end will have a CGA connection with a check valve specific for the gas being used which will attach directly to the cylinder. This is a metal-to-metal seal and no Teflon tape or other thread sealant should be used.

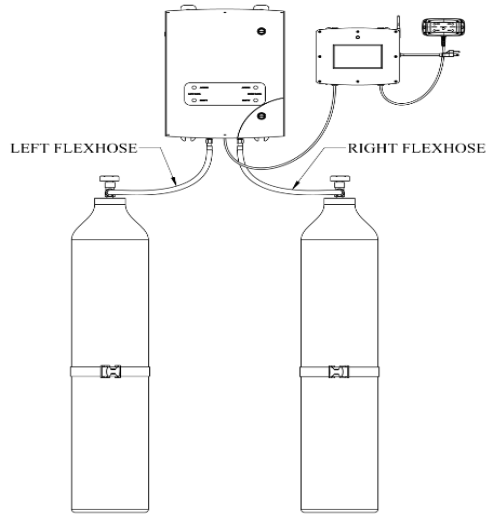

Figure 2 – Two Cylinder Setup

Manifold for more than two (2) cylinders

Harris uses a modular header system for attaching multiple cylinders to the DataSmart manifolds (Ref. Figure 4). See Figure 3 for proper installation. The modular design allows greater flexibility for expansion and/or re-configuration of your multi-cylinder gas manifold. Below are detailed instructions on how to install the modular headers.

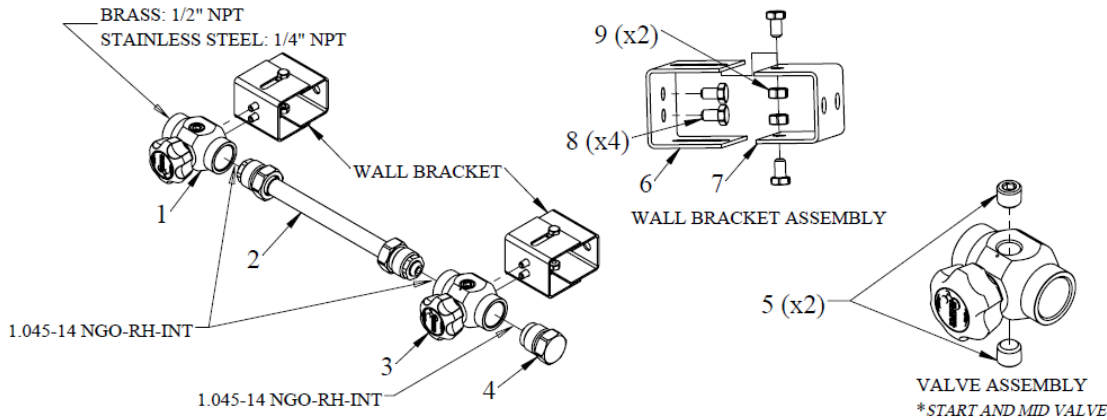

Figure 3 – Modular Manifold Installation

| ITEM | DESCRIPTION | PART NO. | ITEM | DESCRIPTION | PART NO. | ITEM | DESCRIPTION | PART NO. |
|------|---------------------|----------|------|-----------------|----------|------|---------------|----------|
| 1 | START VALVE | | 3 | MID VALVE | | | SS VALVE PLUG | 9000553 |
| | BRS START VALVE | 9105192 | | MID VALVE BRS | 9105194 | 6 | VALVE BRACKET | 9009502 |
| | SS START VALVE | 9105193 | | MID VALVE SS | 9105195 | 7 | WALL BRACKET | 9009503 |
| 2 | HEADER TUBE | | 4 | HEADER PLUG | | 8 | SCREW | 9009505 |
| | HEADER TUBE 5" BRS | 9105188 | | HEADER PLUG BRS | 9105185 | 9 | NUT | 9009504 |
| | HEADER TUBE 10" BRS | 9105187 | | HEADER PLUG SS | 9105186 | | | |
| | HEADER TUBE 5" SS | 9105184 | 5 | VALVE PLUG | | | | |
| | HEADER TUBE 10" SS | 9105183 | | BRS VALVE PLUG | 9000495 | | | |

Table 1 – Component Part Legend for Modular Headers

The header manifold is to be attached to a wall or other secure structure. Each valve will have a typical distance of either 5" or 10" from center to center depending on length of tube being used. The header assembly does not come with mounting hardware as the customer should choose fasteners appropriate for the mounting surface.

1. The start valve (1) has two openings, one end connecting to the manifold hub and the other end to the header tube. NOTE: Brass models will have a ½" NPT opening and Stainless Steel models will have a ¼" NPT opening.

2. The start valve (1) opening will be used to connect to the inlet of the manifold hub. On the opposite end, a 1.045-14 NGO opening will be used to attach the header tube.

3. To connect the start valve to header tube, a 1-⁵/₈" wrench and 1-¹/₈" wrench will be required. Use the 1-⁵/₈" wrench to hold the valve body and the 1-¹/₈" wrench to tighten the header tube. Torque each header tube (2) connection to 40 ft-lbs.

4. Connect mid valve (3) to the unattached end of the header tube. Ensure valve bodies are parallel to one another. Use the 1-⁵/₈" wrench to hold the valve body and the 1-¹/₈" wrench to tighten the header tube. Torque to 40 ft- lbs.

5. Following steps 2 and 3, attach additional header tubes and mid valves as required by application.

6. On the final mid valve (3) of the assembly, connect header plug (4) to the rear opening. Use the 1-⁵/₈" wrench to hold the valve body and the 1-¹/₈" wrench to tighten the plug. Torque to 40 ft-lbs.

7. Attach a valve bracket (6) to every valve in the assembly using the screws (8) provided.

8. Match header assembly dimensions to the mounting surface. Properly align and fasten wall bracket to the mounting surface.

9. Mount the header assembly by connecting the valve bracket (6) and wall bracket (7) using the provided screws and nuts. The wall bracket assembly allows for distance adjustments from mounting surface to the header assembly.

10. Attaching the hoses: Remove either bottom or top plug (5) on the valve. Assemble pigtail to valve block using teflon tape to seal the threads. Wrench tighten from 18 ft-lbs up to 25 ft-lbs of torque.

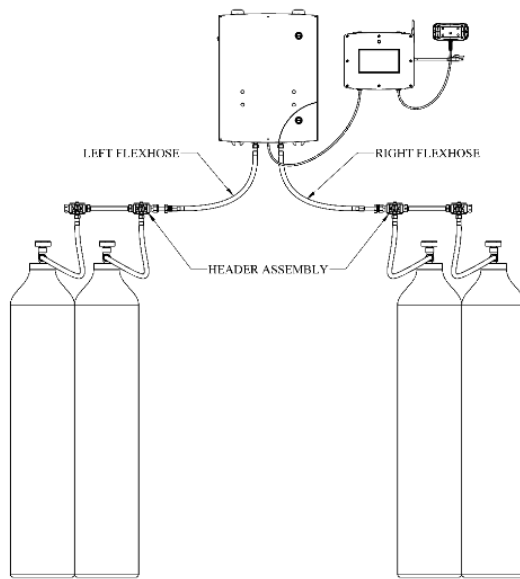

Figure 4 – Multi-Cylinder Setup

PRESSURIZING THE DATASMART MANIFOLD SYSTEM

1. The DataSmart manifold should be fully assembled with cylinders, headers and all flexible hoses attached and torqued to the proper specs.
2. The outlet port on the Mechanical Enclosure should be plugged, or, if utilizing an outlet isolation valve, make sure it is in a closed position. If this is not possible, turn the adjusting screw on the outlet regulator counter-clockwise until it turns freely. This will insure that there is no outlet pressure when initially pressurizing the system. The outlet regulator adjusting screw can be accessed from outside the Mechanical Enclosure by removing the plug from the right side top.
3. Once this is complete, *S-L-O-W-L-Y* pressurize the system by turning on cylinder valves and/or header valves for both the right and left sides. Check each joint for leaks with an approved leak detection solution or warm soapy water. Increase torque slightly, at each joint, if needed, to eliminate leaks.
4. Do not torque any connection to greater than 60 ft-lbs. If leaks cannot be eliminated, contact your distributor or Harris Products Group Technical Service.

DATASMART OPERATION INSTRUCTIONS

1. Connecting to Power

- a. Connect cable from Mechanical Enclosure to the Touchscreen Control Box
- b. If included, connect the A/V Remote Alarm Box to the Touchscreen Control Box
- c. Connect the Touchscreen Control Box to a 120VAC 50/60Hz power source.

CAUTION: Connection to an incorrect voltage can cause serious damage to the product and will void the warranty.

2. DataSmart Initial Setup

- a. Follow the steps below to configure the DataSmart for first-time use. Initial configuration values may be changed at any time. When the system starts up for the first time it will present a list of steps that must be taken before it will be fully functional. Press the button to the right of each step to set the corresponding values. As each step is completed, the button will show a green check mark to indicate success. Notification icons in the lower left corner of the screen indicate functionality, mode and wi-fi connection status.

1. Once connected to power, the DataSmart will boot up and default to the login screen (See Figure 5). Log in to the system. The factory default Username and Password are as follows. These can be changed at any time by accessing Machine Username Password Update from the System Configuration screen.

Username: **HPG_AMS**

Password: **HPG@123**



Figure 5

2. **Create Machine Name:** Machine Name is a way to easily identify a unit in the analytics dashboard. If there are multiple DataSmart systems tied to a specific contract, each system must be uniquely named. Enter a name for the unit and press **OK** to save. NOTE: Machine name should not contain any special characters such as #, @ etc. The Machine Serial Number will be assigned prior to purchase and will be visible upon first start-up.

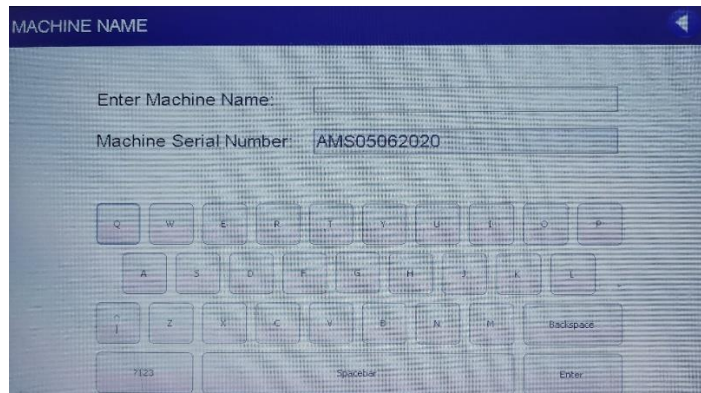

Figure 6 – Machine Name Screen

3. **Configure Wi-Fi:** Select the appropriate SSID (Wi-Fi Network Name) to allow connectivity to the DataSmart server. Enter the password and press **OK** to save. An active Wi-Fi connection is required to complete this step and to initialize the unit. If the DataSmart machine is unable to connect to a Wi-Fi network, it is recommended to turn the power off, then re-start the machine and return to the Configure Wi-Fi step. If no password is required for the WiFi network, then press ENTER at the password screen to bypass this requirement. The unit cannot access a WiFi network that requires a terms of use acknowledgement, even if no password is required. Adding the MAC Address to the WiFi network can help facilitate connection.

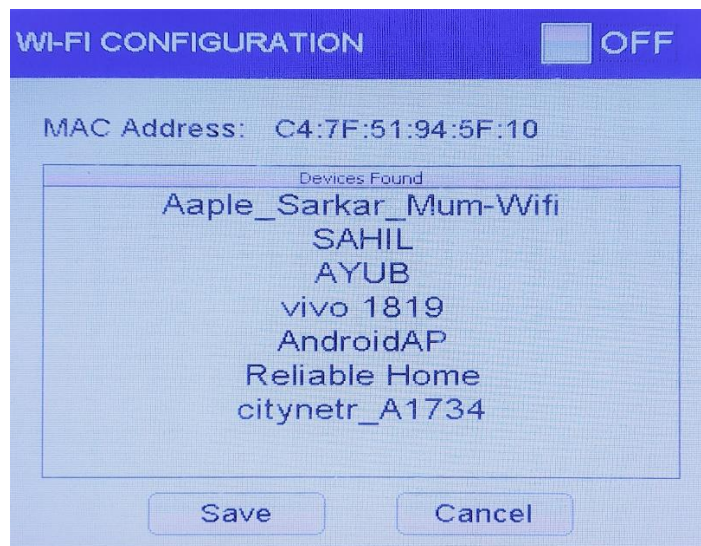

Figure 7 – WiFi Setup

4. **Registration Code:** Enter the registration code that was provided as part of the DataSmart agreement. Press **OK** to save. The unit will contact the DataSmart server to validate the code. Depending on your internet connection speed, it may take several minutes to complete this step.

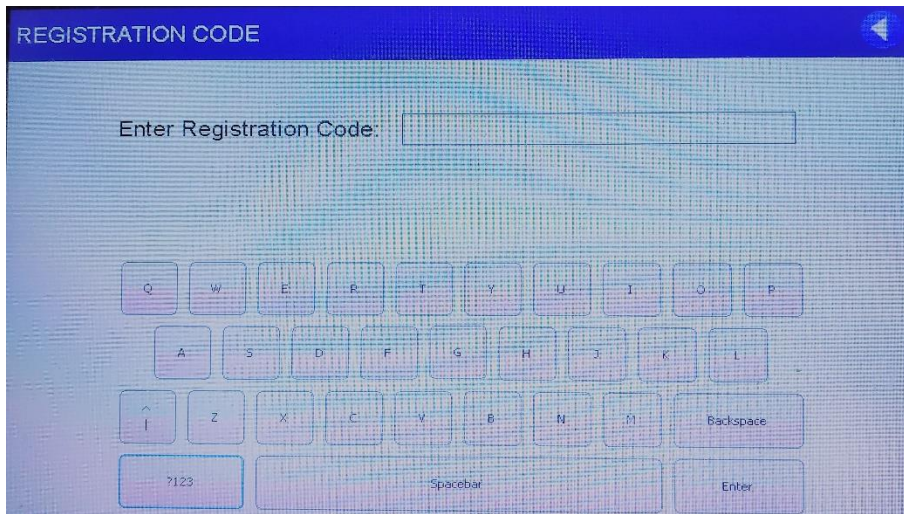

Figure 8 – Registration Code

5. **Telemetry Configuration:** Select the appropriate configuration for your setup:
 - a. AMS is the integrated telemetry system (recommended)
 - b. Standalone telemetry with integrated sensor (user will connect using DataSmart sensors)
 - c. Standalone telemetry with end-user sensors (user will connect their sensors)

6. **User Selectable Features:** Configure the settings for operation:

- a. Unit of Measurement – select Imperial or Metric
- b. System Priority – select the side of the distribution system that DataSmart should prioritize for gas delivery: Left Bank; Right Bank; First In, First Out (FIFO).

NOTE: Liquid cylinders or bulk systems should always be the priority bank, i.e., a liquid dewar that is on the left side should be set up as Left Bank Priority. If there are liquid dewars on both sides, then priority should be set as FIFO.

- c. Bank Configuration – DataSmart will enter bank configuration based upon System Priority selection. Select Gas Source and Gas Type for each bank based upon your setup. The available Gas Types are determined by the Gas Source selection. **Note:** Bulk System or Liquid Dewar should always be set as the Gas Source on the **PRIMARY** bank.

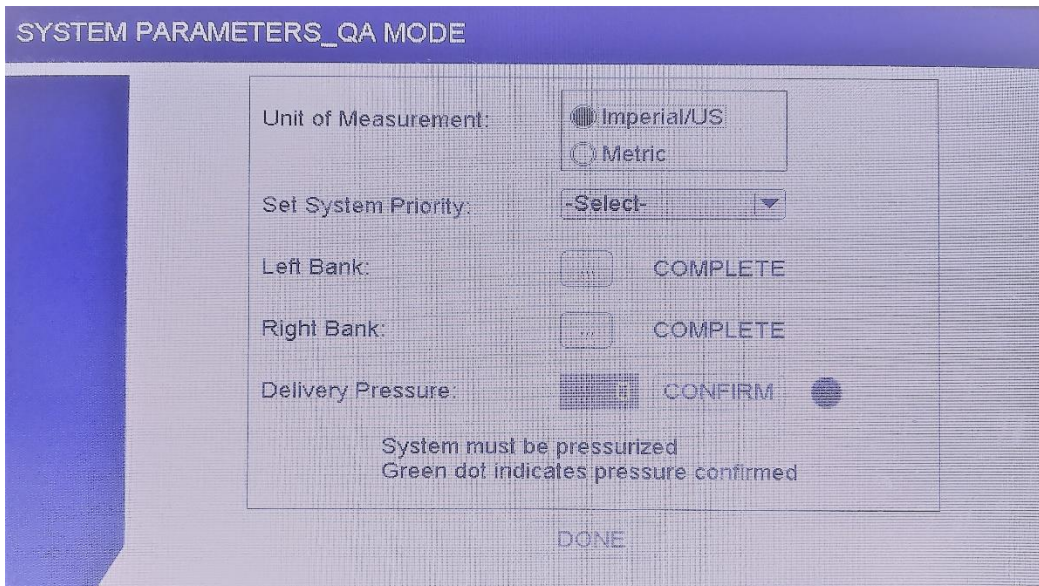

Figure 9 – Units and System Priority

- d. The following parameters must be selected and programmed on initial setup:
1. Choose Pressure Cylinder, Liquid Dewar, Cylinder Bank or Bulk system from the drop-down menu for both right and left sides.

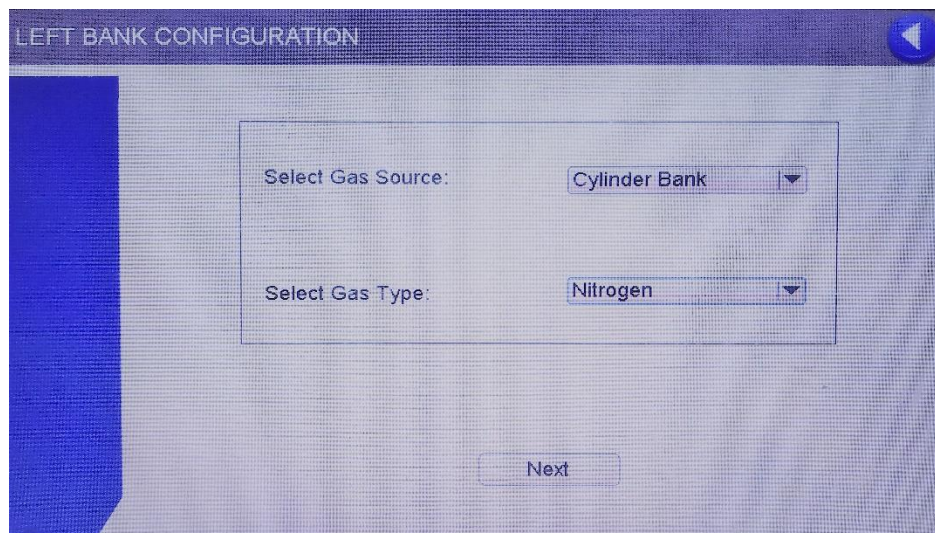

Figure 10 – Bank Configuration

2. Select cylinder relief valve pressure for each liquid dewar
3. Program desired switchover pressure for each side. Switchover pressure can be adjusted up or down in 12 psig increments.

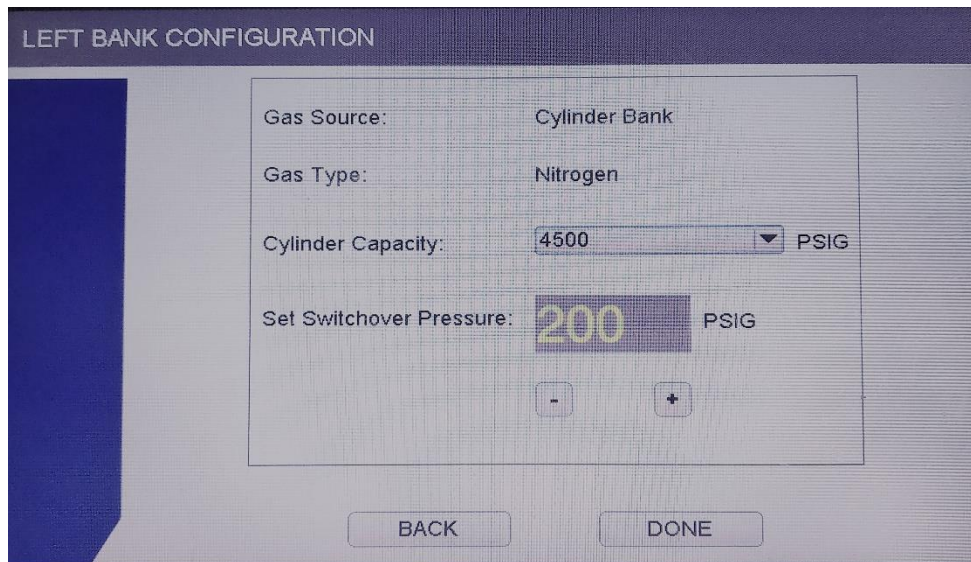

Figure 11 – Bank Configuration

4. Select Container Size if using a bulk system
5. Daily Decay Venting Allowance % (Bulk system only)
6. Adjust outlet regulator to desired pressure (access port from outside the Mechanical Enclosure)

Once the two banks are configured, the system is ready to begin gas flow. Press **CONFIRM** to verify that the Delivery Pressure is correct. Press **DONE** to complete the setup process.

DATASMART PRODUCTION ANALYTICS

Once the machine is installed and connected to the internet via a WiFi network, the production analytics can be created which will give important data regarding your gas usage. From your computer or mobile device, go to <https://DataSmart.harrisproductsgroup.com/login> to access and set up the analytics. You will have to contact Harris Products Group Customer Service at 800-241-0804 Option 2 to set up your account and register. Once your subscription service has been activated, follow the directions on the web application to set up messages and alerts based on your desired conditions at the gas manifold.

The web application can also generate reports on gas usage, switchover times and historical data to help better manage your gas system.

APPENDIX A

Cloud-Based Architecture

DataSmart is a cloud-based system. This means that there is no dedicated computer required in your company to collect and store the data. Each machine requires a wireless internet connection in order to report production data. DataSmart initiates the transfer of information through a firewall to the data center. Data is transferred directly from DataSmart. Production data is accessible using a web browser and a secure login.

Security and Data Storage

Each DataSmart customer's data is stored in a state-of-the-art data center. When viewing the DataSmart application, high-security, industry-standard encryption is used. The hosting center is a SSAE 16 SOC 2 Type II compliant facility. SSAE 16, also called Statement on Standards for Attestation Engagements 16, is a regulation created by the Auditing Standards Board (ASB) of the American Institute of Certified Public Accountants (AICPA) for redefining and updating how service companies report on compliance controls.

It is an acceptable method to obtain assurance of a service organization's internal controls without conducting separate assessments. Successful completion of the SSAE 16 SOC 2 Type II examination indicates that the processes, procedures, and controls have been formally evaluated and tested by an independent auditing firm. A service auditor's examination performed in accordance with SSAE 16 SOC 2 Type II (Trust Principles) is widely recognized. It represents that a service organization has been through an in-depth audit of their control objectives and control activities, which often include controls over information technology and related processes. A Type II report not only includes the service organization's description of controls but also includes detailed testing of the design and operating effectiveness.

The hosting center environment is built with state-of-the-art equipment, technology investments, and operational expertise. There is an established disaster recovery program with redundancy and fail-over to protect the information stored in the system.

Access Requirements

Each computer or mobile device must have access to the Internet to connect to DataSmart. All DataSmart machines require access to the Internet to send data to the DataSmart data center. Every DataSmart machine is identified by a unique device ID. This ID number is saved during registration and sent with each DataSmart data packet to store the data. Refer to Chapter 2 Preparing for CheckPoint® for additional information.

Accessing Data

Access to company data is limited to DataSmart users assigned to a Company by that Company's Administrator. A user can be assigned to multiple Companies and will have access to each Company's data each time they log in. Depending on the User Role provided by the Administrator, the user may have access to Equipment Configuration and User Management settings.

Network Capacity

Networks and Internet connections have limited bandwidth for sending data. Each DataSmart machine uses a small amount of bandwidth. To estimate the bandwidth on your network, you can multiply the number of DataSmart machines by the data quantity of data packets:

- Every 5 minutes, each DataSmart machine sends a data frame to the DataSmart data center; the data packet is about 68 Bytes in size.
- The data frames use most of the available bandwidth. When estimating bandwidth, allow at least 10% for additional occasional traffic and other network communications. If the network or Internet connection is lost, the DataSmart machine continues to collect and buffer data until the network connection is re-established. Once the Internet connection is reestablished, all the data is sent to DataSmart.

APPENDIX B

Wiring Diagram

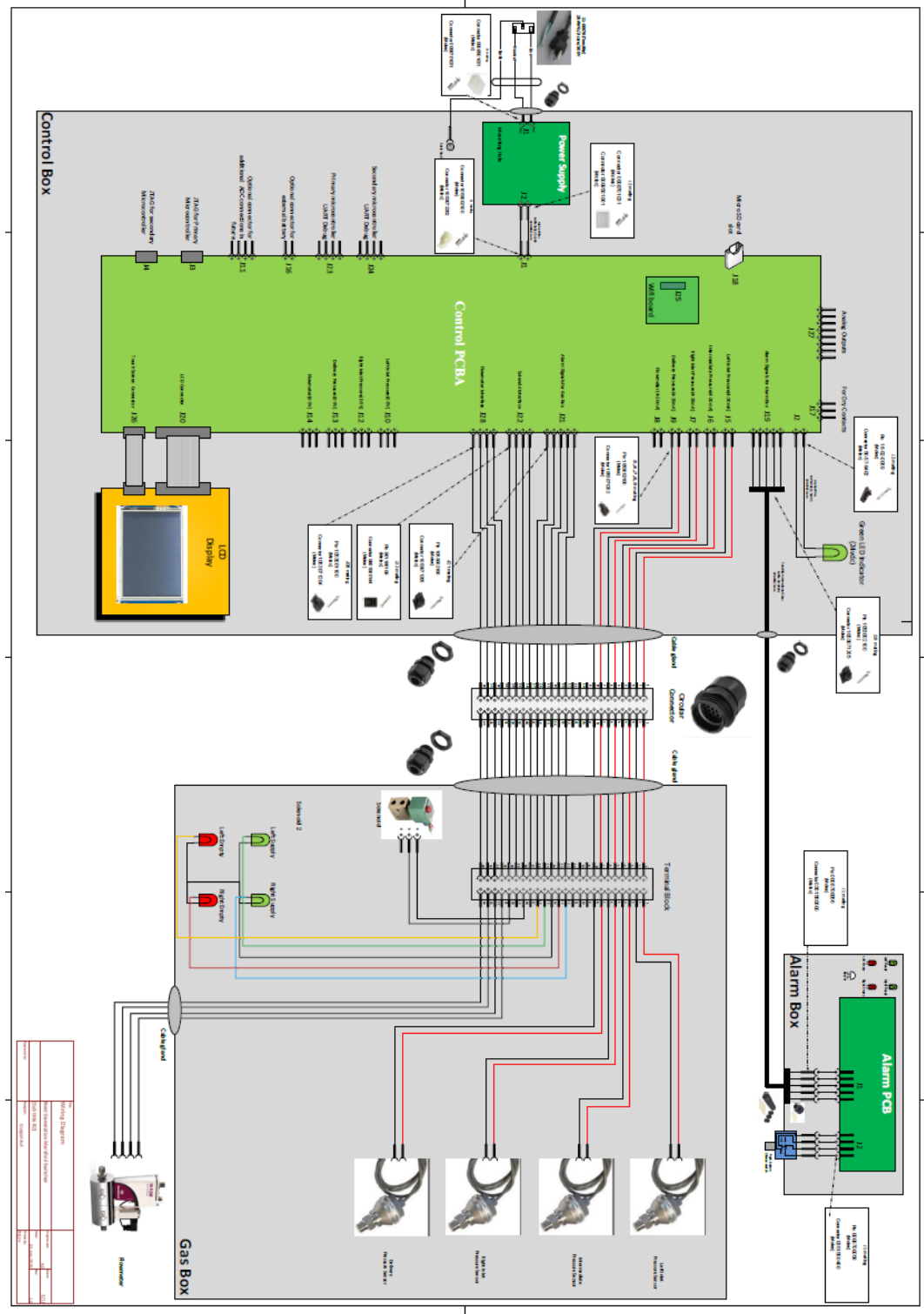

| | | |
|--|--|--|
| | | |
|--|--|--|

APPENDIX C

Troubleshooting Guide

| <u>Problem</u> | <u>Possible Cause</u> | <u>Solution</u> |
|---|---|---|
| | | |
| System does not boot up | No power | Check to make sure control box is plugged up |
| | Cables not connected properly | Check cable connectors to make sure they are engaged |
| | Blown fuse | Check the fuse to see if it is blown/ replace if |
| | | |
| LCD screen frozen; cannot edit | Internal software error | Reboot the system |
| | | |
| Cannot connect to WiFi | Internal firewall | Contact your IT department; see section "Preparing for DataSmart" and Appendix A |
| | | |
| Lost WiFi connection | Poor signal strength | Check signal strength and reconnect |
| | | |
| Error message when programming switchover pressures | Pressure differential between right side and left side switchover is greater than 150 psi | There cannot be more than 150 psi difference between the right side and left side switchover pressures. Readjust to parameters within this range. |
| | | |
| System does not switch over | Switchover pressures not programmed | Program both right and left side switchover pressures |
| | Switchover pressures set too low | Check switchover pressure settings and adjust to |
| | | |
| System switches back and forth | Switchover pressures not set properly | Check to see that the switchover pressures are not set too high. Contact Harris Technical Service for guidelines on where switchover pressures should be |
| | System not sized correctly for liquid dewars | More cylinders may need to be added; contact Harris Technical Service for recommendations. |
| | | |
| Cannot access DataSmart Web Applications | No subscription | Contact Harris Customer Service to set up service. |
| | No WiFi Connection | Reconnect to WiFi |
| | Not registered | Obtain registration number from machine and go to https://datasmart.harrisproductsgroup.com/login |
| | | |
| No gas flow through manifold | Flexible hose assembled incorrectly | Check flow direction arrows on all flex hoses |
| | Outlet regulator not set | Adjust outlet regulator to desired outlet pressure |
| | | |

Appendix D

Piping and Instrumentation (P&ID) Diagram

Model 763 DataSmart GUI Instructions

Overview

The Model 763 DataSmart onboard GUI will allow users to update configuration settings, view operational parameters, and view basic analytical data. Using an internet connection through Wi-Fi, the controller can optionally allow for remote administration and mobile/email operational alerts, as well as data transmission and analysis. The system will require an internet connection for user administration, initial configuration, and data transmission.

The first time setup will require an internet connection so that parameters such as the machine serial number and name and the customer identifier (registration code) can be transmitted to the server. An optional data subscription plan will be available to the customer at an additional cost; however, this service will be available as a preview over the initial 60 days of system operation.

All users will be administered through the AMS web application. User information will be synchronized (pushed) to each applicable unit when updates are made. It is expected that all customer users will be set up during the initial 60-day grace period should the customer decide to not purchase the subscription plan. All authentication on the unit shall be done using the local synchronized credentials.

Splash Screen

This screen is displayed every time the system starts up.

Note Actual Model name will change – this is a placeholder

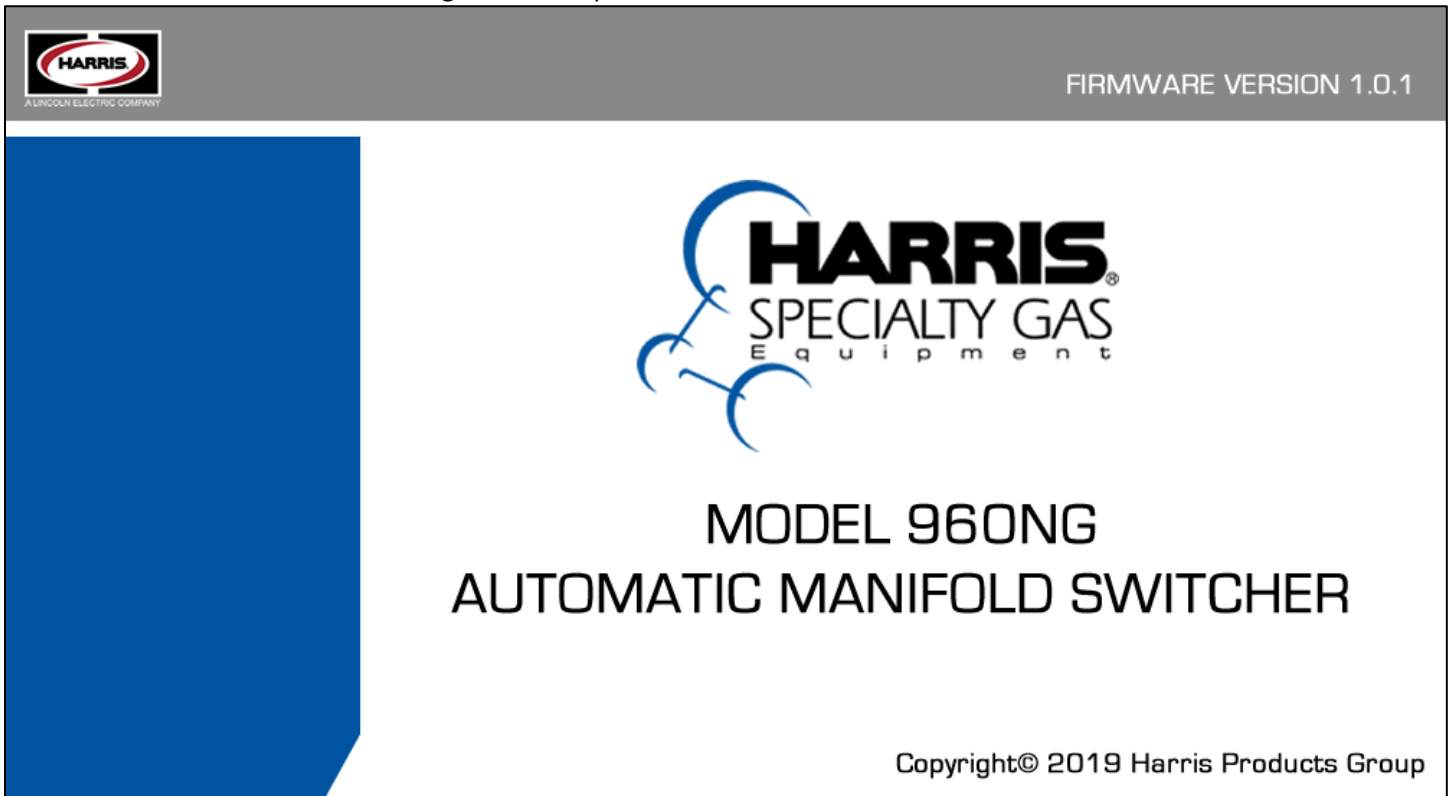

Initial Setup/Configuration

On the initial startup, the system will prompt the user to set the Machine Name, select a Wi-Fi network, validate the registration code for the subscription, and set the operation mode parameters. The system will not allow the user to proceed until all steps are complete.

If the master QA code (AMS\$QT#2019) is entered as the Machine Name, this will bypass the remaining steps and allow the system to be used with full functionality for quality testing (QA mode) during manufacture. In this scenario:

- The system serial number is entered and saved to memory
- Wi-Fi is set independent of any setup process
- The basic functionality of the system is tested with the use of a master password to access controlled areas
- Master password is set on the system using the system serial number
- QA mode can only be used once. After powering down while in QA mode, the system resets and loads the initial configuration wizard upon next power-up.

If the Erase Code/Password (HPG\$ERASE#NFLASH) is entered as machine name then it will erase the entire machine setting along with the Log data. In this scenario user have to reconfigure the entire system





Machine Initialization

As the user completes each step, the system will change the ellipsis button to a static indicator (green check mark).

Step 1

SYSTEM CONFIGURATION 

The following steps must be completed to configure the system:

1. Create Machine Name 
2. Configure Wi-Fi 
3. Registration Code 
4. Telemetry Configuration 
5. System Parameters 





QA Mode Password: AMS\$QT#2019, Erase Code/Password(HPG\$ERASE#NFLASH)

MACHINE NAME 

Enter Machine Name:

Machine Serial Number:



Pressing  returns the user to the previous screen without saving changes. Pressing Enter saves the configuration. A confirmation message shall be presented to the user.

Step 2

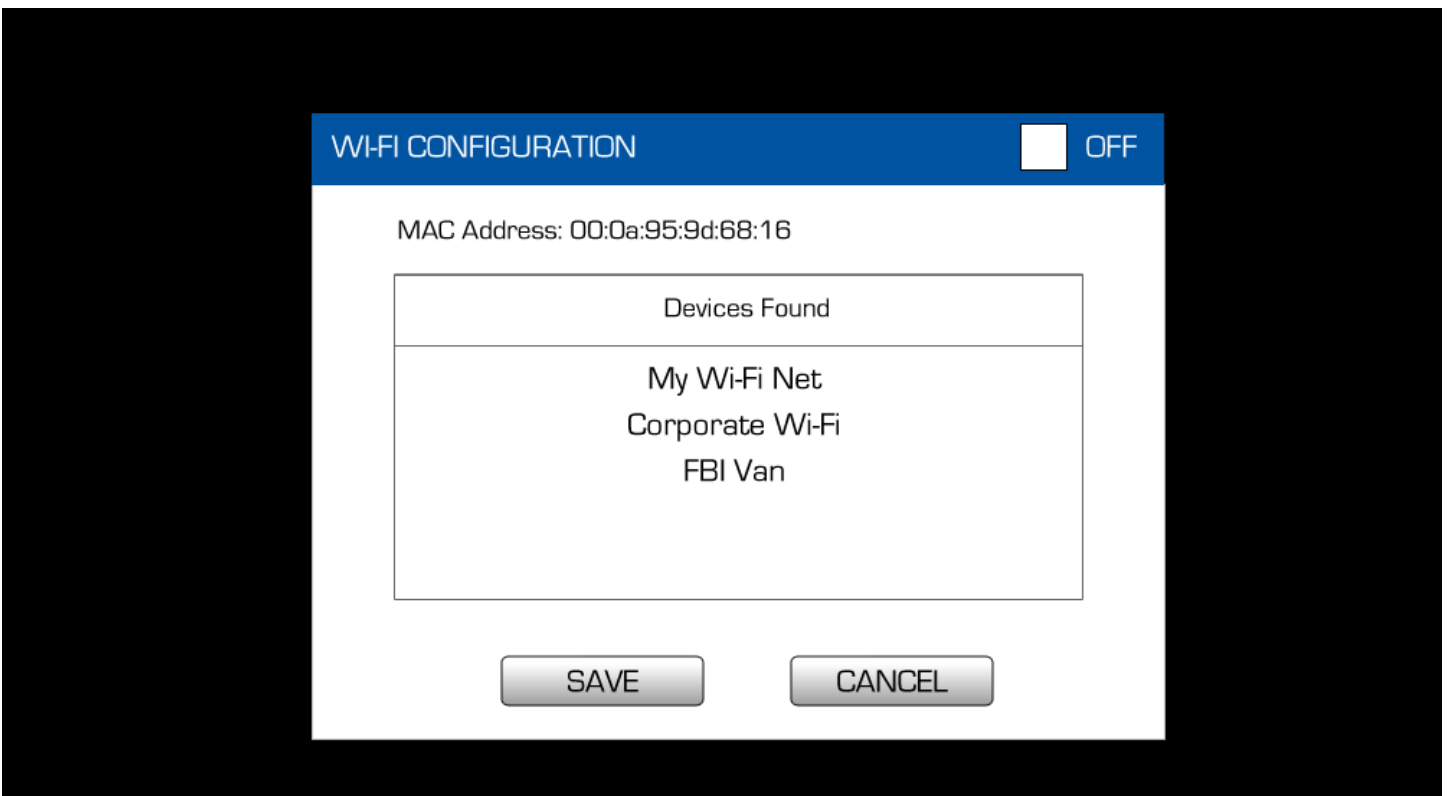
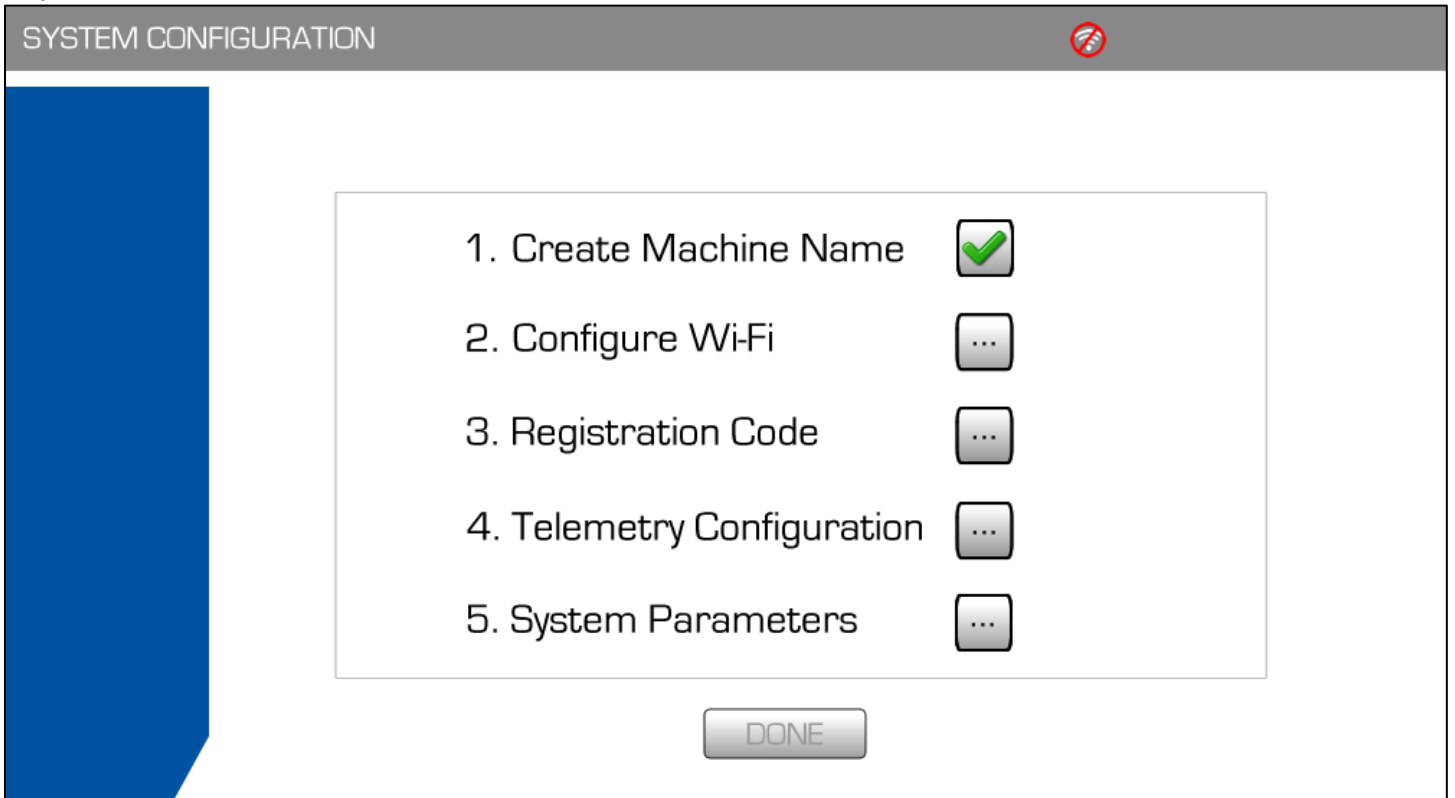



Enter Password:



Pressing  returns the user to the previous screen without saving changes.





Pressing Enter saves the configuration. A confirmation message shall be presented to the user.

Note: If the selected Wi-Fi (access point) don't have the password(Open Network) then the user should not fill anything under the Enter Password field (i.e. the field should be blank) and directly press the Enter button

IMPORTANT: The "Configure Wi-Fi" button needs to remain enabled, even after the user has completed this step, to allow the user to select a different Wi-Fi SSID in case the selected SSID blocks the data or otherwise does not allow the transmission to complete. A scenario would be a corporate wi-fi network that is available but blocks or otherwise meters connections.

Step 3



1. Create Machine Name 
2. Configure Wi-Fi 
3. Registration Code 
4. Telemetry Configuration 
5. System Parameters 

DONE



Enter Registration Code:



Pressing  returns the user to the previous screen without saving changes.

Pressing Enter saves the configuration. A confirmation message shall be presented to the user.

When the registration code is validated during initial setup, the machine will transmit the following information to the server:

- Registration code
- Machine Name
- Machine Serial Number

This data will be sent in one string with individual values separated by pipes using the format Registration Code|Machine Name|Serial Number

Example:

- Registration Code: Plvu55r1
- Machine Name: Station 1
- Machine Serial Number: 325AAA123

String to send to server: Plvu55r1|Station 1|325AAA123

Note: spaces in Machine Name will need to be URL encoded (%20)

Example service call (**Note – this endpoint URL will change**):

<http://pfservice.harrisproductsgroup.com/api/manifold/Plvu55r1|Station%201|325AAA123>

The server will return the expiration date of the subscription and the date/time for the machine. The machine date/time will be set using the values sent from the server. When the machine date reaches the subscription expiration date, the system will send the same call to the server to retrieve the updated subscription date.

Step 4

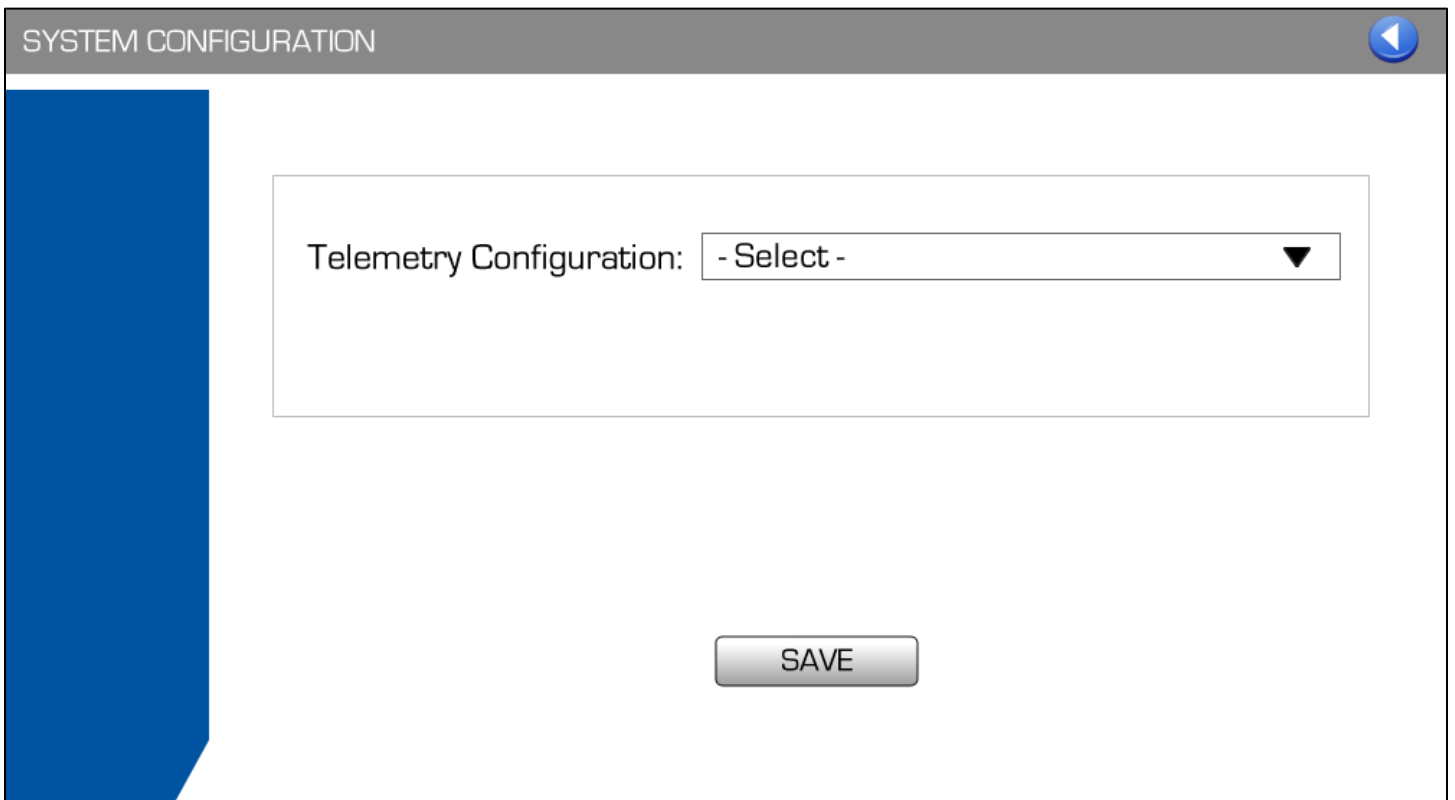
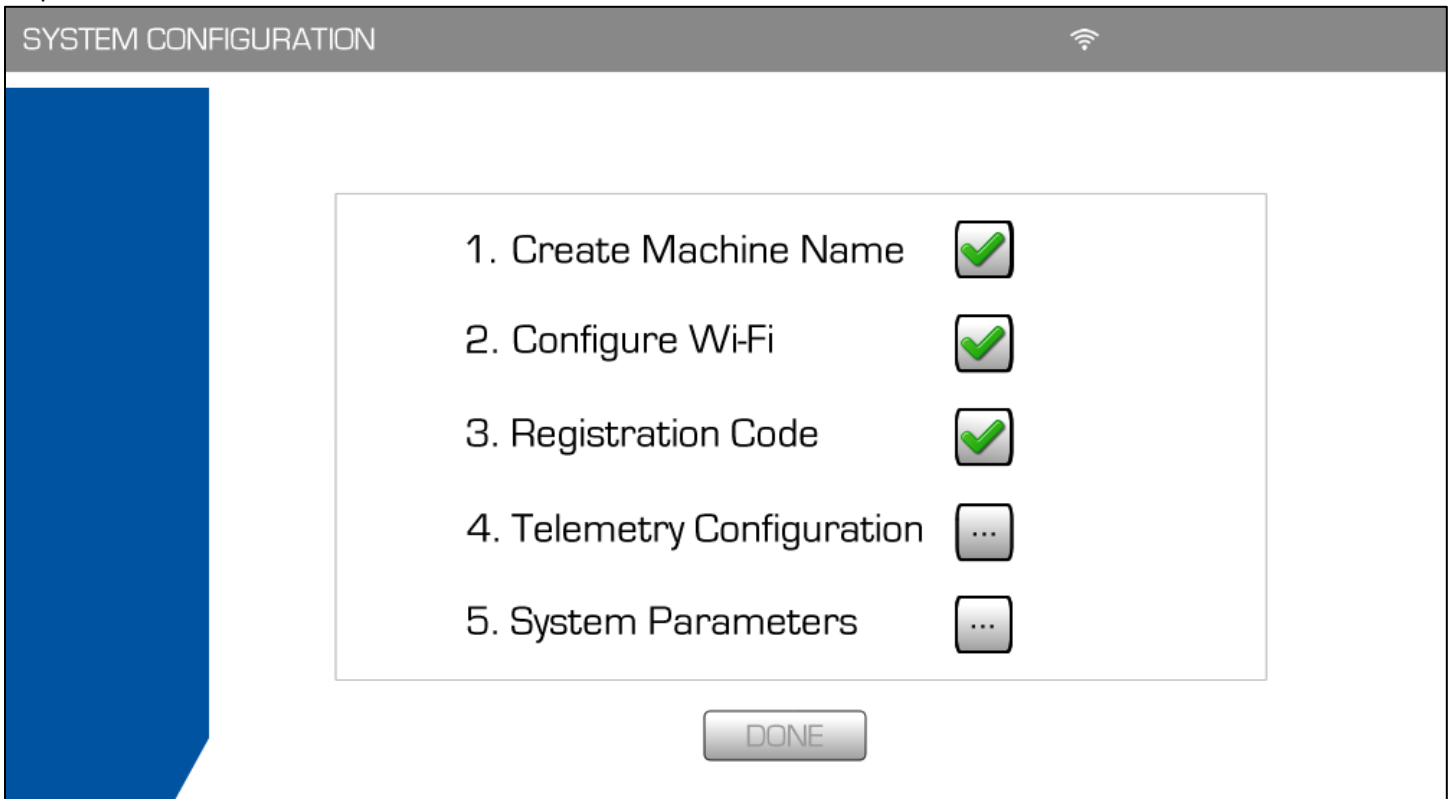

Telemetry Configuration selection options:

- Integrated system with Gas Block NG960
- Standalone telemetry with integrated sensor
- Standalone telemetry with end-user selected sensors

Note: The Telemetry configuration is settable through the Dip switch connected on the Control board and based on the Dip switch configuration setting the Telemetry type will be automatically available under the dropdown. User have to verify the telemetry type and press enter.

Dip Switch Configuration in below table:

| SINo | Dip Switch 1 Position | Dip Switch 2 Position | Telemetry Type |
|------|-----------------------|-----------------------|---|
| 1 | ON | ON | AMS with integration Solution with Gas Box |
| 2 | OFF | ON | AMS with integrated Solution (Standalone) |
| 3 | ON | OFF | AMS Telemetry with End user current sensor (Standalone) |
| 4 | OFF | OFF | AMS Telemetry with End user voltage sensor (Standalone) |

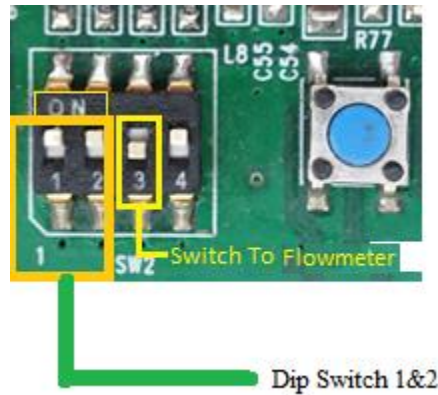

The final step is to configure the operation mode. The user must accept the disclaimer by pressing OK before proceeding to configuration.

SYSTEM PARAMETERS

IMPORTANT

All elements of this system must be fully assembled, pressurized and leak tested prior to starting parameter configuration.

System Parameters – initial screen

SYSTEM PARAMETERS

Unit of Measurement: US Standard
 Metric

Set System Priority: - Select - ▼

Left Bank: [...] COMPLETE

Right Bank: [...] COMPLETE

Delivery Pressure: [] CONFIRM ●

System must be pressurized
Green dot indicates pressure confirmed

DONE

The first step is to set the Unit of Measurement (radio buttons):

SYSTEM PARAMETERS

Unit of Measurement: US Standard
 Metric

Set System Priority: - Select - ▼

Left Bank: [...] COMPLETE

Right Bank: [...] COMPLETE

Delivery Pressure: [] CONFIRM ●

System must be pressurized
Green dot indicates pressure confirmed

DONE

If the user presses the Imperial/US radio button to change the Unit of measurement then new screen will popup as shown below



Select Pressure UoM:

PSIG ▼

Select Flow UoM:

SCFH ▼

CONFIRM

Available UoM in Imperial

For Pressure: PSIG only

For Flow

SCFH

SCFM

If the user press at the Metric radio button to change the Unit of measurement then new screen will popup as shown below

The screenshot shows a dialog box titled "UNIT OF MEASUREMENT: METRIC" with a back arrow in the top right corner. On the left side, there is a blue vertical bar. The main content area contains two rows of labels and dropdown menus. The first row is "Select Pressure UoM:" followed by a dropdown menu showing "Bar". The second row is "Select Flow UoM:" followed by a dropdown menu showing "LPH". At the bottom center of the dialog is a "CONFIRM" button.

Available UoM in Metrics

For Pressure:

BAR, kPa,MPa

For Flow

LPH, LPM,M3/h

The second step is to select System Priority:

- LEFT BANK
- RIGHT BANK
- FIRST IN FIRST OUT (FIFO)

When the user selects a bank (Left or Right), they will automatically be taken into the corresponding screen to configure. Upon pressing DONE they will then be taken to the opposite bank screen to configure. Upon pressing DONE they will be returned to the main configuration screen. If the user selects FIFO, the user will automatically be taken to the Left Bank to configure. Upon pressing DONE they will then be taken to the Right Bank screen to configure.

In the following scenario the user selects LEFT BANK as Primary. The first step is to select the gas source:

LEFT BANK CONFIGURATION

Select Gas Source: - Select -

Select Gas Type: - Select -

NEXT

Available Gas Sources:

- Pressure Cylinder
- Cylinder Bank
- Liquid Dewar
- Bulk System

Gas Type is dependent on Gas Source selection.

Pressure Cylinder and Cylinder Bank:

- Nitrogen
- Helium
- Hydrogen
- Oxygen
- Carbon Dioxide
- Argon
- Air
- Propane

- Ammonia
- Carbon Monoxide
- Methane
- Acetylene
- Nitrogen Dioxide

Liquid Dewar and Bulk System:

- Nitrogen
- Oxygen
- Carbon Dioxide
- Argon



Pressing  returns the user to the previous screen without saving changes.

Press NEXT to continue.

If the user selects Pressure Cylinder or Cylinder Bank with Telemetry option 1 (Integrated system with Gas Block NG960) or 2(Standalone telemetry with integrated sensor):

LEFT BANK CONFIGURATION

Gas Source: Pressure Cylinder
Gas Type: Nitrogen
Cylinder Capacity: - Select - ▼ PSIG

Set Switchover Pressure: 200 PSIG
- +

BACK DONE

If the user selects Pressure Cylinder or Cylinder Bank with Telemetry option 3 (Standalone telemetry with end-user selected sensors):

LEFT BANK CONFIGURATION

Gas Source: Pressure Cylinder
Gas Type: Nitrogen
Cylinder Capacity: - Select - ▼ PSIG
Sensor Reading @ 20MA: PSIG
Sensor Reading @ 4MA: PSIG
Set Switchover Pressure: 200 PSIG
- +



BACK DONE

- Cylinder Capacity
- 3000

- 4500
- 6000

Pressing BACK returns the user to the previous screen without saving changes.



Switchover pressure is changed by pressing  to decrease and  to increase. Pressure value increases and decreases in increments of 12. Default pressure is set to 200. Minimum allowable pressure is 70; maximum allowable pressure is 2400.

Cylinder Capacity and Sensor Readings are required fields. Default Switchover Pressure (200) can be used.

If the user selects Liquid Dewar or Bulk System with Telemetry option 1 (Integrated system with Gas Block NG960) or 2(Standalone telemetry with integrated sensor):

LEFT BANK CONFIGURATION

Gas Source: Liquid Dewar
Gas Type: Nitrogen
Container Size: PSIG
Daily Decay Venting Allowance % (x.x):
Set Switchover Pressure: **200** PSIG
- +

BACK DONE



If the user selects Liquid Dewar or Bulk System with Telemetry option 3 (Standalone telemetry with end-user selected sensors):

LEFT BANK CONFIGURATION

Gas Source: Liquid Dewar
Gas Type: Nitrogen
Container Size: PSIG
Sensor Reading @ 20MA: PSIG
Sensor Reading @ 4MA: PSIG
Daily Decay Venting Allowance % (x.x):
Set Switchover Pressure: **200** PSIG
- +

BACK DONE

Pressing BACK returns the user to the previous screen without saving changes.

Switchover pressure is changed by pressing  to decrease and  to increase. Pressure value increases and decreases in increments of 12. Default pressure is set to 200. Minimum allowable pressure is 70; maximum allowable pressure is 2400.

Container Size and Daily Decay Venting Allowance (and Sensor Readings for config 3) are required fields. Default Switchover Pressure (200) can be used.

When the user clicks DONE, the system shall save the configuration and start configuration for the Right Bank. The screen is the same, except the top title is changed to RIGHT BANK CONFIGURATION.

If the user exits out of the process by pressing BACK or  before bank configuration is complete, the system shall display the System Parameter configuration screen with the status of their progress. The user cannot click DONE until all steps are completed, and they would have to configure each bank independently.

If the touch is detected at any of the edit box (i.e. Sensor reading @ 20 mA: or at Sensor reading @ 4 mA) then the new screen will be popped-up as shown below, user will have to enter the corresponding values in the respective fields for the sensor readings and will press the enter.

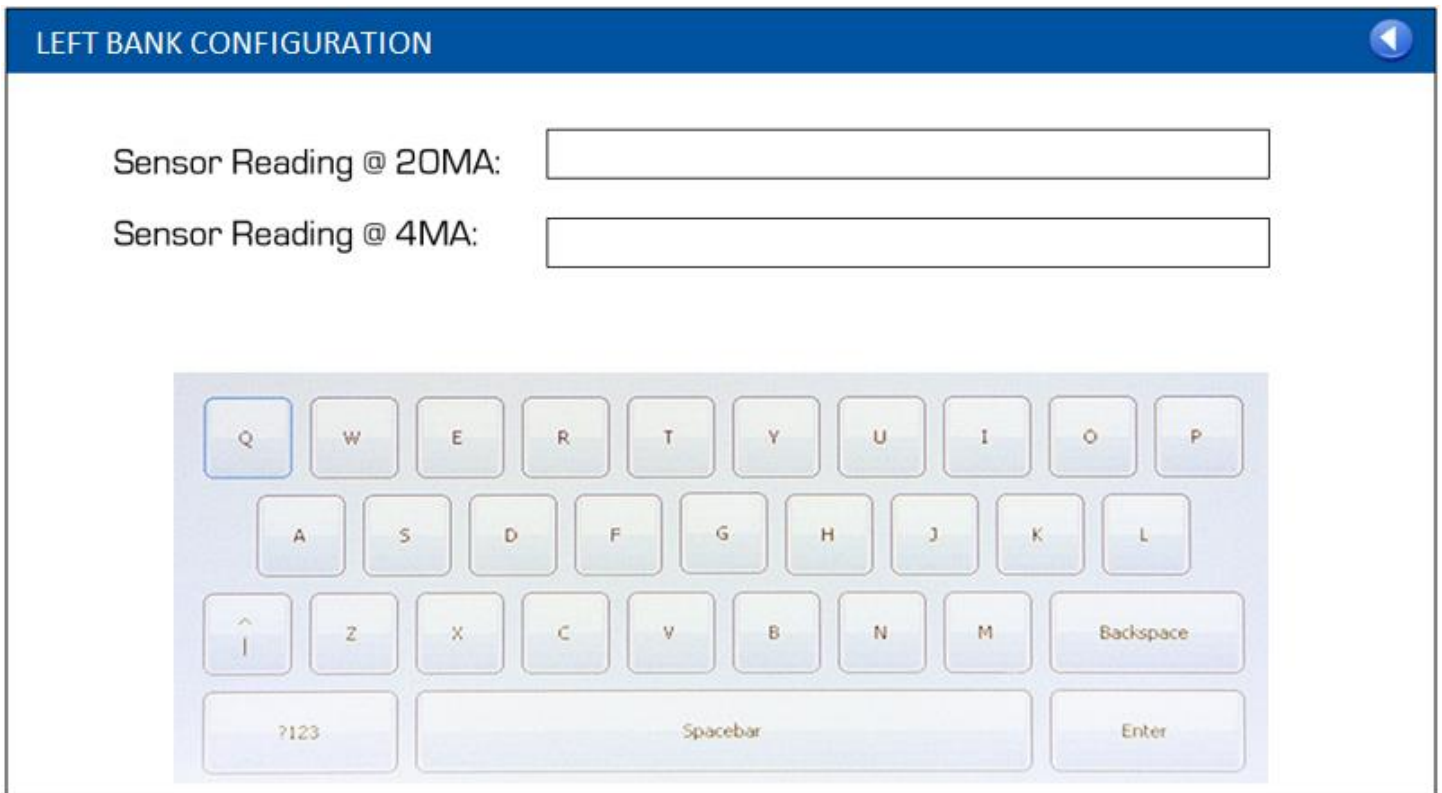

If the enter is pressed then value will be stored and screen will automatically go back to the previous screen. If the return button is pressed then the screen will automatically go back to the previous screen without updating the value for sensor reading

If the touch is detected at any of the edit box (Container Size: or at Daily Decay Venting Allowance%[x.x]:) then the new screen will pop up as shown below, user will enter the value corresponding to the container size and daily decay and will press the enter.

The screenshot displays a configuration screen titled "LEFT BANK CONFIGURATION" with a blue header bar containing a back arrow icon. Below the header, there are two input fields: "Container Size:" and "Daily Decay Venting Allowance % [x.x]:". Below these fields is a virtual keyboard with the following layout:

| | | | | | | | | | |
|-------|----------|---|---|---|---|---|---|-----------|---|
| Q | W | E | R | T | Y | U | I | O | P |
| A | S | D | F | G | H | J | K | L | |
| ^ | Z | X | C | V | B | N | M | Backspace | |
| ?123 | Spacebar | | | | | | | Enter | |

If the enter is pressed then value will be stored and screen will automatically go back to the previous screen. If the return button is pressed then the screen will automatically go back to the previous screen without updating the value for sensor reading

If the user selects a non-bulk gas source on the non-primary side, the user needs to be notified that it's not a desired setting. So, for example, the user selects LEFT BANK as primary, then selects Liquid Dewar or Bulk Cylinder as the gas source on the right side. The user must accept the following disclaimer to proceed:

BANK CONFIGURATION

IMPORTANT

If using a Bulk System or Liquid Dewar, that source should be set as primary.

OK

Until both Banks are configured, the system will reflect the bank status with a check mark:

SYSTEM PARAMETERS

Unit of Measurement: Imperial/US
 Metric

Set System Priority: LEFT BANK ▼

Left Bank: COMPLETE

Right Bank: COMPLETE

Delivery Pressure: CONFIRM ●

System must be pressurized
Green dot indicates pressure confirmed

DONE

Once the two banks are configured, the system will begin gas flow. Delivery Pressure will be displayed. The user must press CONFIRM to verify that the Delivery Pressure is correct:

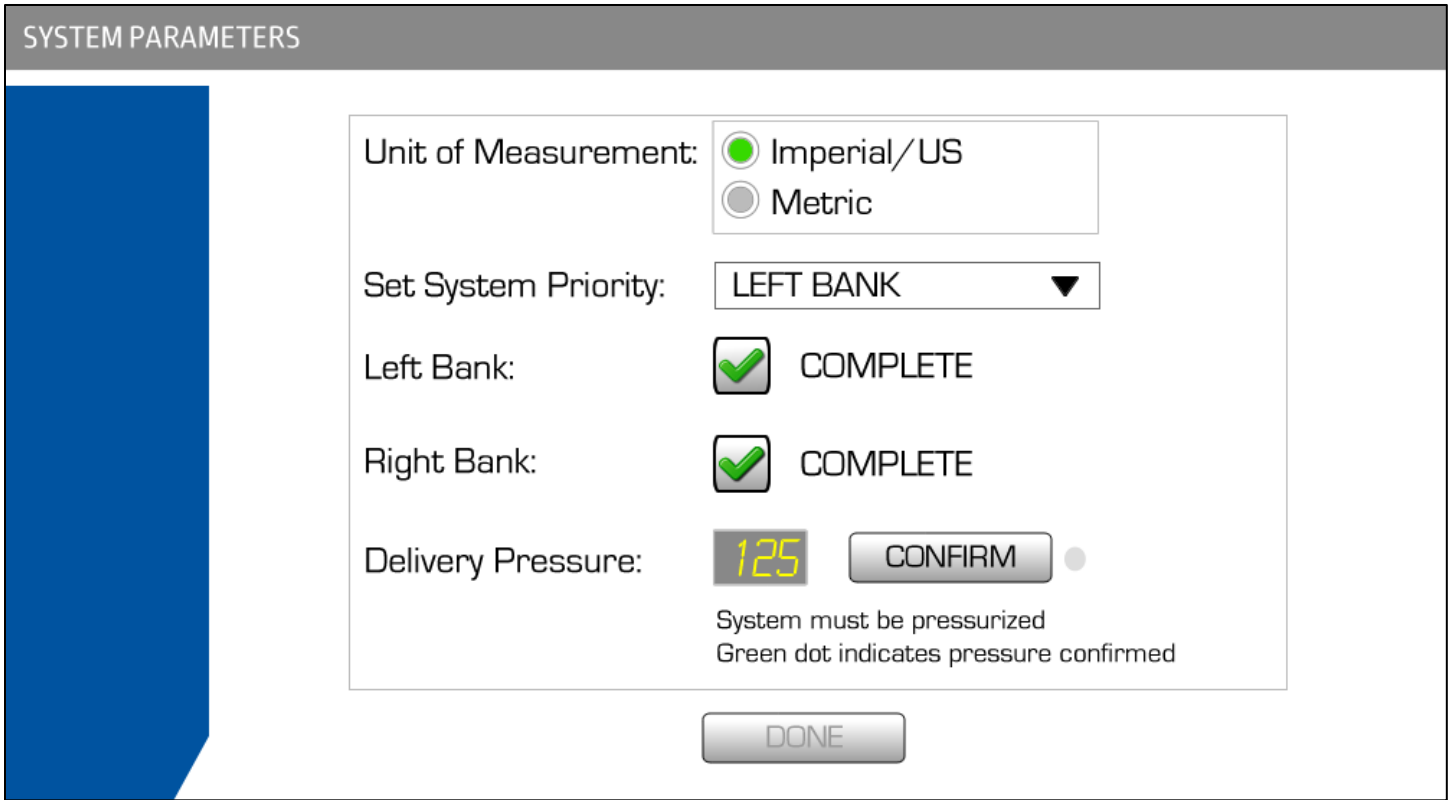

Once the Delivery Pressure has been confirmed, the confirmation light appears green; the configuration is complete and the DONE button is made available.

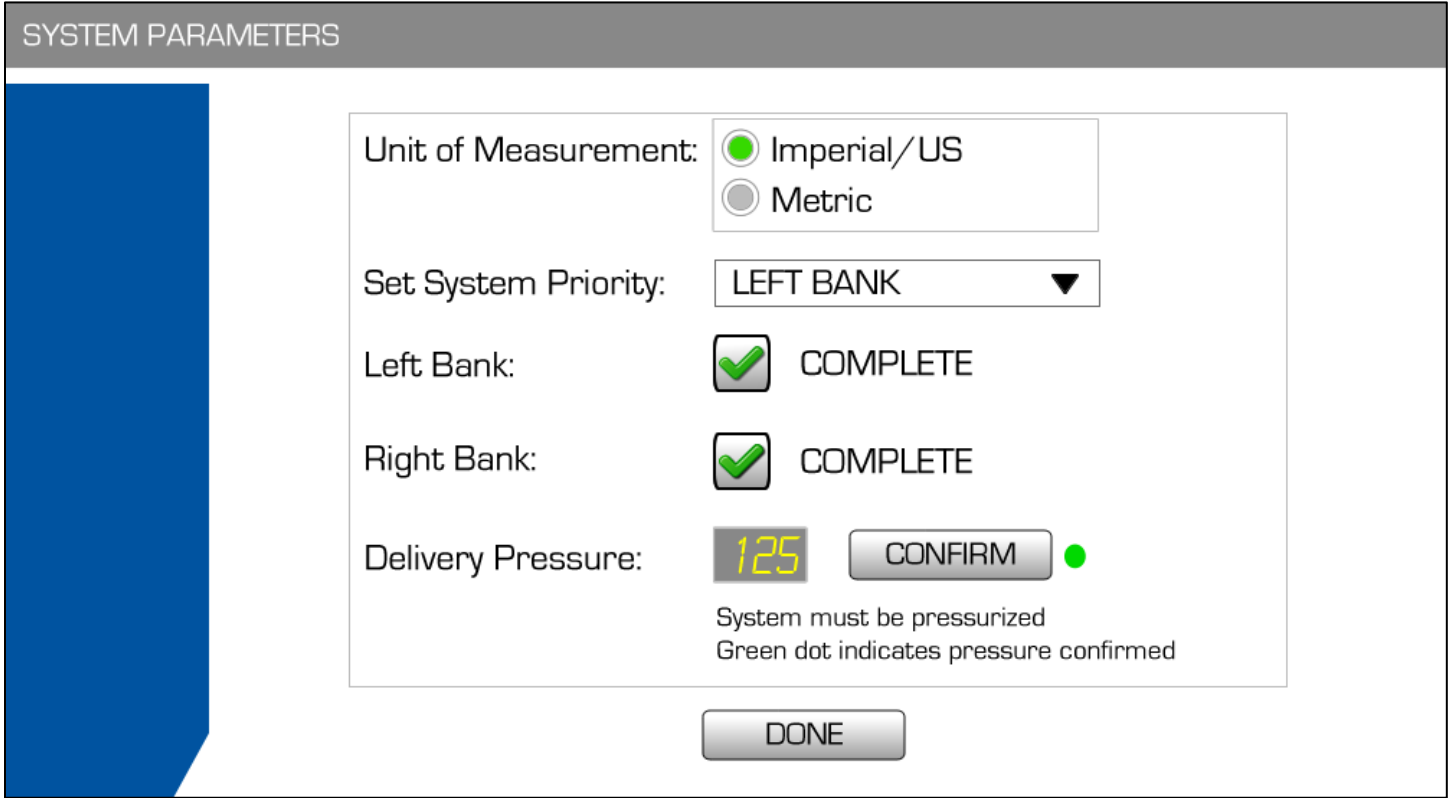

When the user presses DONE, the system shall save the configuration and return the user to the main "wizard" to close out system initiation.

The following steps must be completed to configure the system:

- 1. Create Machine Name
- 2. Configure Wi-Fi
- 3. Registration Code
- 4. Telemetry Configuration
- 5. System Parameters



DONE

Pressing DONE completes the process and directs to the Operation Mode screen.

Operation Mode

Showing Pressure Cylinder graphics

SYSTEM 1 Machine Name 11/11/2016 13:45

| | | | | | | |
|--|---|-----------|------------|----------|----------|---|
| <p>LEFT BANK Pressure Cylinder</p>  <p>● Active</p> | <p>Priority: LEFT BANK Gas Type: Nitrogen Delivery Pressure: 80 PSIG Intermediate Pressure: 80 PSIG Gas Flow: 30 SCFH</p> <table border="0"><tr><td>LEFT BANK</td><td>RIGHT BANK</td></tr><tr><td>200 PSIG</td><td>100 PSIG</td></tr></table> <p>EDIT SYSTEM CONFIG</p> <p>● Active</p> | LEFT BANK | RIGHT BANK | 200 PSIG | 100 PSIG | <p>RIGHT BANK Pressure Cylinder</p>  <p>● Active</p> |
| LEFT BANK | RIGHT BANK | | | | | |
| 200 PSIG | 100 PSIG | | | | | |

Cylinder Bank graphics

SYSTEM 1
Machine Name
📶 11/11/2016 13:45

LEFT BANK
Cylinder Bank

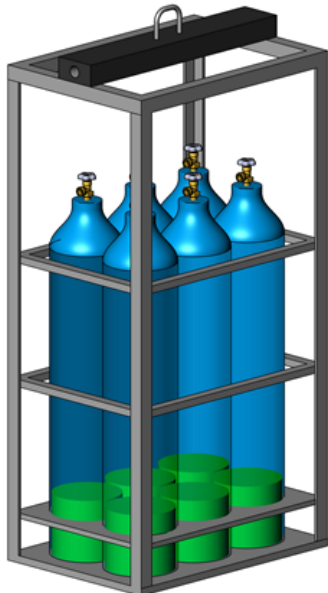

● Active

Priority: LEFT BANK

Gas Type: Nitrogen

Delivery Pressure: 80 PSIG

Intermediate Pressure: 80 PSIG

Gas Flow: 30 SCFH

| | |
|---|---|
| LEFT BANK | RIGHT BANK |
| 200 | 100 |
| PSIG | PSIG |

EDIT
SYSTEM CONFIG

RIGHT BANK
Cylinder Bank

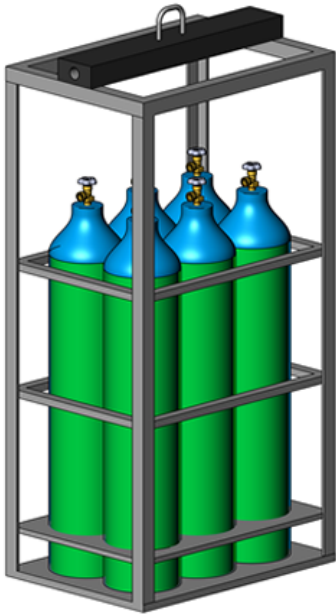

● Active

Liquid Dewar graphics

SYSTEM 1
Machine Name
📶 11/11/2016 13:45

LEFT BANK
Liquid Dewar



● Active

Priority: LEFT BANK

Gas Type: Nitrogen

Delivery Pressure: 80 PSIG

Intermediate Pressure: 80 PSIG

Gas Flow: 30 SCFH

| | |
|---|---|
| LEFT BANK | RIGHT BANK |
| 200 | 100 |
| PSIG | PSIG |

EDIT
SYSTEM CONFIG

RIGHT BANK
Liquid Dewar



● Active

Bulk System graphics

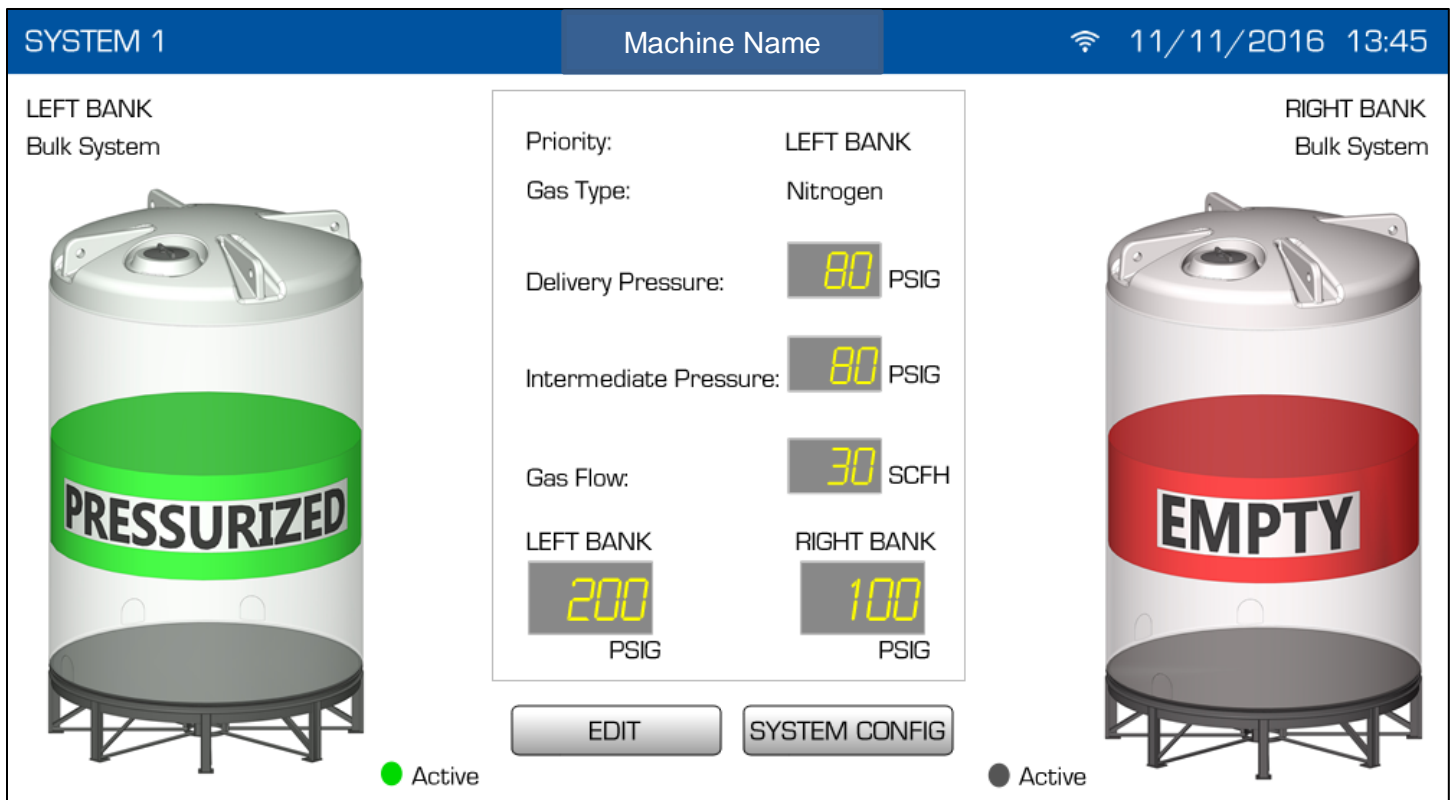

Operation Mode will display the configuration settings as set by the user: Priority; Gas Source for each bank. A graphic will display for each bank that will correspond to the approximate available gas in each bank: 0-20%; 21 – 40%; 41-60%; 61-80%; 81-100%. The active indicator will only be displayed if the bank is active; otherwise it will be hidden (right side shown as grey in this graphic for placement purposes only).

If the system is shut down, the user will be returned to the Operation Mode screen when it is restarted, using the same operating configuration that was in place at the time of shutdown.

If the user presses EDIT or SYSTEM CONFIG, they must use a user name/password combination to authenticate.

During the initial system setup, configuration values can be set without entering any credentials. After that initial setup is complete, the user must log in. User accounts will be set up through the web application, and will be pushed to the machine when saved in the web interface. The machine will store this user information (maximum of 10 users per any individual machine), and will authenticate using the local stored information.

Machine will have the default local user name and password stored in machine itself, user can change the default local user name and password if necessary. After the change of user name and password the default user name and password cannot be used. If the user forget the local user name and password then the default local user name and password can be retried by entering the wrong user name and password 10 times.

The user name and password setup at web application will not be stored in the machine, but those user name and password are accessible in the machine through web application.

Default Local UserName: HPG_AMS
 Default Local Password: HPG@123



Enter User Name:

Enter Password:



Pressing EDIT allows an authenticated user to change the System Priority and/or bank settings:



Unit of Measurement: Imperial/US
 Metric

Set System Priority: LEFT BANK ▼

Left Bank: ...

Right Bank: ...

Delivery Pressure: 125 CONFIRM ●

System must be pressurized
 Green dot indicates pressure confirmed

DONE

Pressing  returns the user to operation mode without saving changes. Pressing DONE saves the configuration and returns the user to the Operation Mode screen. Pressing either of the ellipsis buttons beside a bank edits the corresponding bank.

Note: Banks are edited independently once initial configuration is complete (a user may want to only edit one bank). The edit screens are the same as the initial config screens and the rules are the same. The only difference is that the configured values are displayed for the fields.

LEFT BANK CONFIGURATION

Select Gas Source: Pressure Cylinder ▼

Select Gas Type: Nitrogen ▼

NEXT

Pressing  returns the user to the previous screen without saving changes. Pressing NEXT moves to the next screen.

LEFT BANK CONFIGURATION

Gas Source: Pressure Cylinder

Gas Type: Nitrogen

Cylinder Capacity: 6000 ▼ PSIG

Sensor Reading @ 20MA: 6000 PSIG

Sensor Reading @ 4MA: 0 PSIG

Set Switchover Pressure: 200 PSIG

- +

BACK DONE

Press DONE to save the configuration and return to the main configuration screen.



Unit of Measurement: Imperial/US
 Metric

Set System Priority: LEFT BANK ▼

Left Bank: [...]

Right Bank: [...]

Delivery Pressure: 125 CONFIRM ●

System must be pressurized
Green dot indicates pressure confirmed

DONE

If the user presses SYSTEM CONFIG from the Operation Mode screen, they can change system configuration settings. Access to this area requires a valid user name/password.

Three updates are made

- 1- Username Password Update
- 2- Telemetry Configuration
- 3- Firmware Update

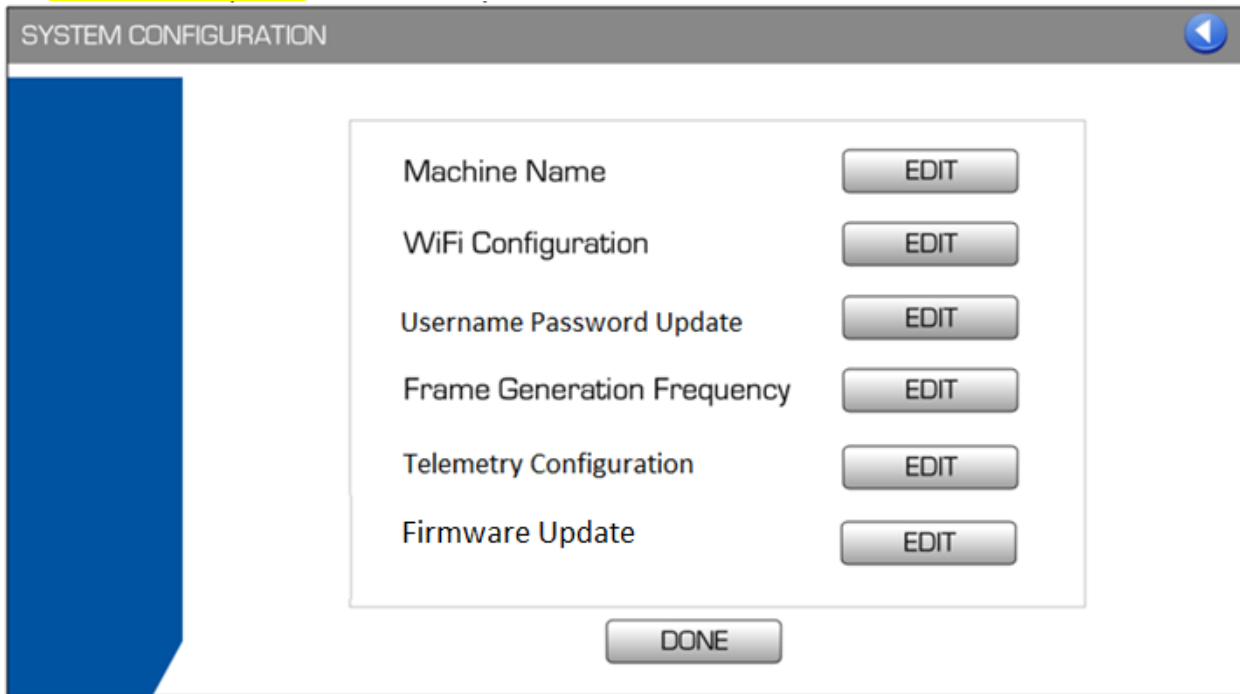

Press DONE to return to Operation Mode.

Note: The EDIT Button for firmware Update will be disabled until new firmware is available to upgrade

Edit Machine Name

There is no option in the system to check the serial number of the machine, hence the below screen is removed and previously used screen to enter the machine name is used here.

Below screen is not used

QA Mode Password: AMS\$QT#2019, Erase Code/Password(HPG\$ERASE#NFLASH)

EDIT MACHINE NAME

Current Machine Name:

Machine Serial Number:

Virtual keyboard layout:
Row 1: Q, W, E, R, T, Y, U, I, O, P
Row 2: A, S, D, F, G, H, J, K, L
Row 3: ^ |, Z, X, C, V, B, N, M, Backspace
Row 4: ?123, Spacebar, Enter

Edit WiFi Configuration:

WI-FI CONFIGURATION OFF

MAC Address: 00:0a:95:9d:68:16

Devices Found

- My Wi-Fi Net
- Corporate Wi-Fi
- FBI Van

SAVE CANCEL



Edit Username Password:

Edit Machine Username Password

Enter New Username

Enter New Password



Edit Frame Generation Frequency:

EDIT FRAME GENERATION FREQUENCY

Current Frequency: 05 Min

Set New Frequency: ▼ Min

Edit Telemetry Type:



Telemetry Configuration:

SAVE

Pressing  returns the user to the previous screen.

Firmware Update:

If the Edit button for firmware update is pressed then below screen will appear, and user have to press OK button in order to start the firmware download

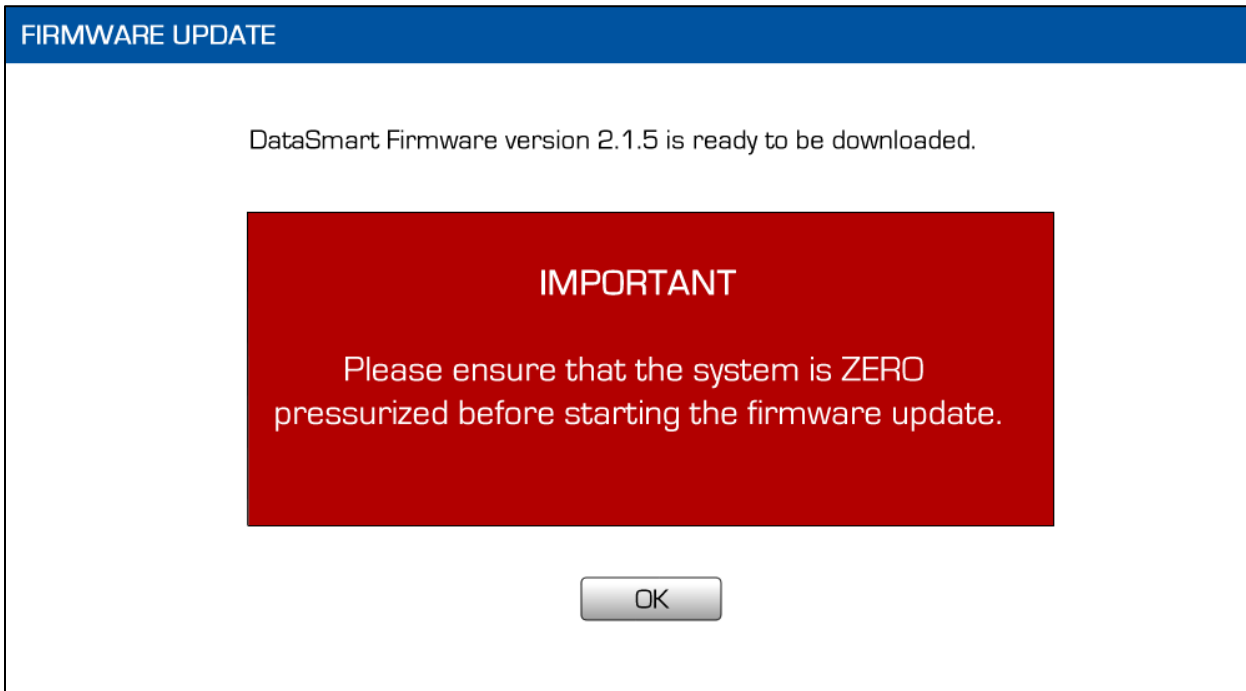

After press on the OK button below screen will appear with progress of the file being downloaded

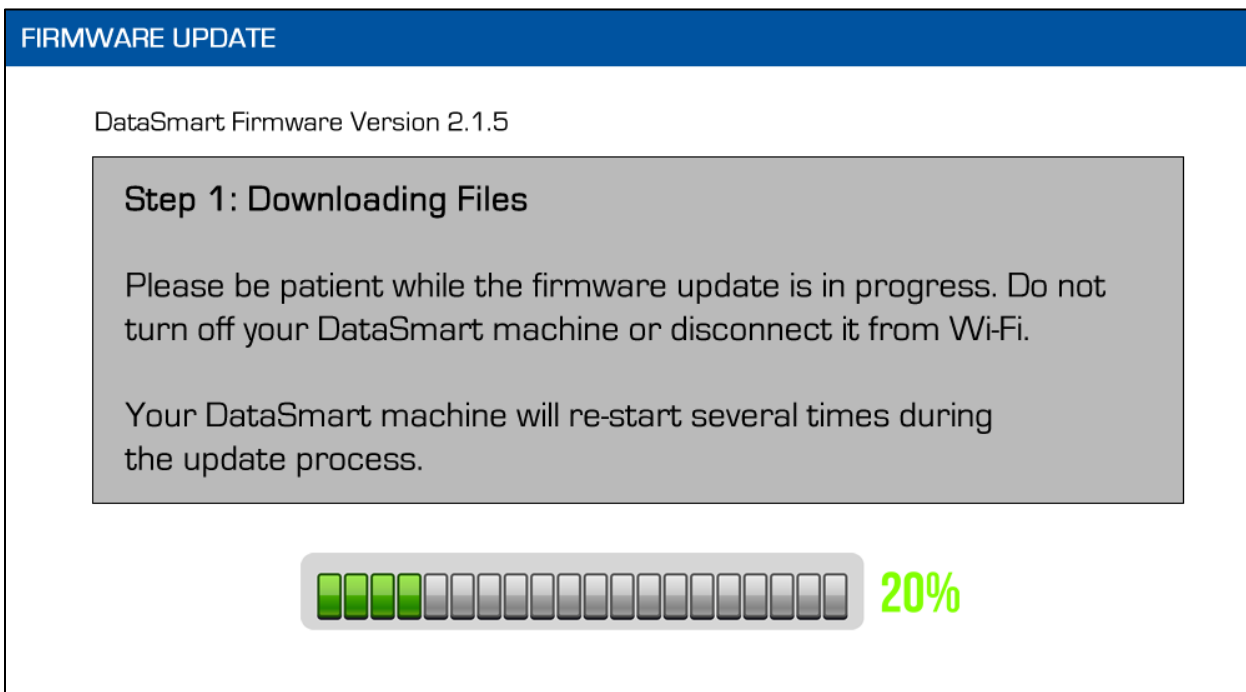

Once the file is downloaded then Machine will restart and below screen will appear with the progress of file being installed

FIRMWARE UPDATE

DataSmart Firmware Version 2.1.5

Step 2: Installing Files

The firmware update is now installing. Please be patient while the update is in process. Do not turn off your DataSmart machine.

The DataSmart machine will restart several times as the firmware is installed.

 60%

After the installation is completed then below screen will appear and user have to press on the Close Button in order to resume the firmware operation

FIRMWARE UPDATE

Update is complete

DataSmart Firmware Version 2.1.5 was installed successfully.

Fonts:

All text: Eurostile

Pressure indicators (digital number fonts): LCD Light (can be represented by equivalent digital number font)

Colors:

Blue: HEX #0053A0

Grey: HEX #888888