

# TOMAHAWK 1025 CCC & 1538 CCC

Spare Parts.....	1
Figure A: Machine Assembly.....	2
Figure B: Machine Assembly.....	4
Electrical Schematic.....	5
CODE: 52133.....	5
CODE: 52134.....	6
LC65, LC65M, LC105 & LC105M.....	7
LC65.....	7
LC65M, LC65M GEAR RACK.....	8
LC105.....	9
LC105M, LC105M GEAR RACK.....	10
LC65 & LC105 Circle Kit (optional).....	11
Torches Dimensions.....	12



# Spare Parts

SP52133/52134 REV01  
11/24

ASSEMBLY PAGE NAME			Machine Assembly Tomahawk 1025	Machine Assembly Tomahawk 1538				
CODE NO.:	K NO.:	FIGURE NO.:	A	B				
52133	K12048-6	TOMAHAWK 1025 CCC	1	-				
52134	K12039-6	TOMAHAWK 1538 CCC	-	1				

\*items highlighted in bold are recommended spare parts

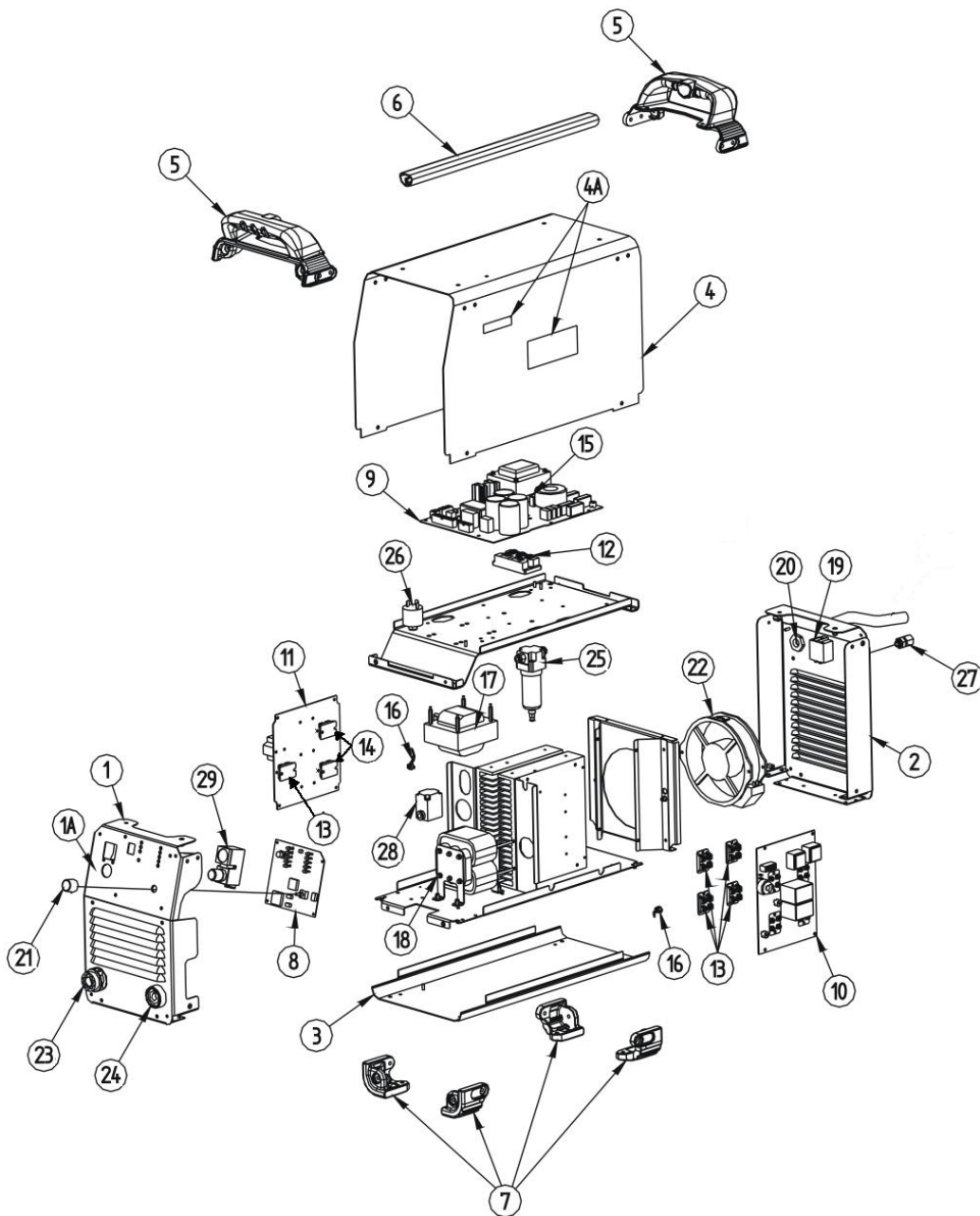

Figure A

**Figure A: Machine Assembly**

Item	Description	Part Number	QTY	1	2	3	4	5	6	7
1	FRONT FRAME	W93X1165R	1	X						
1A	+ FRONT NAMEPLATE	+ W07X0917R	1	X						
2	REAR FRAME	W93X1166R	1	X						
3	BOTTOM FRAME	W93X1134R	1	X						
4	WRAPAROUND	W93X1133R	1	X						
4A	+ KIT SIDE NAMEPLATES TOMAHAWK	+ W07X1117R	2	X						
5	FRONT / REAR HANDLE	W95X1146R	2	X						
6	CENTRAL HANDLE	W92X0228-5R	1	X						
7	KIT 4 ANTI-SLIP FOOT	W95X1147R	1	X						
8	CONTROL P.C. BOARD	W05X0859R	1	X						
<b>9</b>	<b>INPUT P.C. BOARD</b>	<b>W05X0855-1R</b>	<b>1</b>	<b>X</b>						
<b>10</b>	<b>INVERTER P.C. BOARD WITH IGBTs</b>	<b>W05X0857-1R</b>	<b>1</b>	<b>X</b>						
<b>11</b>	<b>OUTPUT P.C. BOARD WITH DIODEs AND IGBT</b>	<b>W05X0858-1R</b>	<b>1</b>	<b>X</b>						
12	POWER INPUT BRIDGE	W4100021R	1	X						
<b>13</b>	<b>POWER IGBTs</b>	<b>W43IA2210AR</b>	<b>5</b>	<b>X</b>						
14	POWER DIODEs	W4060100R	2	X						
15	AUXILIARY FUSE	W7300500R	1	X						
16	THERMOSTAT SENSOR	W9600071R	2	X						
17	OUT INDUCTOR	W58X0872R	1	X						
18	OUT TRANSFORMER	W59X0871R	1	X						
<b>19</b>	<b>SWITCH</b>	<b>W7500203R</b>	<b>1</b>	<b>X</b>						
20	CABLE CLAMP	W8400006R	1	X						
21	KNOB	W8700030R	1	X						
<b>22</b>	<b>FAN</b>	<b>W7200007R</b>	<b>1</b>	<b>X</b>						
23	TORCH SHROUD	W03X0935R	1	X						
24	DINSE CONNECTOR	W7600038R	1	X						
25	AIR FILTER	W8800200R	1	X						
26	PRESSURE SWITCH	W8800019R	1	X						
27	AIR INLET PASS-THROUGH	W8800215R	1	X						
28	SOLENOID VALVE	W8800202R	1	X						
29	PRESSURE GAUGE WITH PRESSURE REGULATOR	W8800203R	1	X						

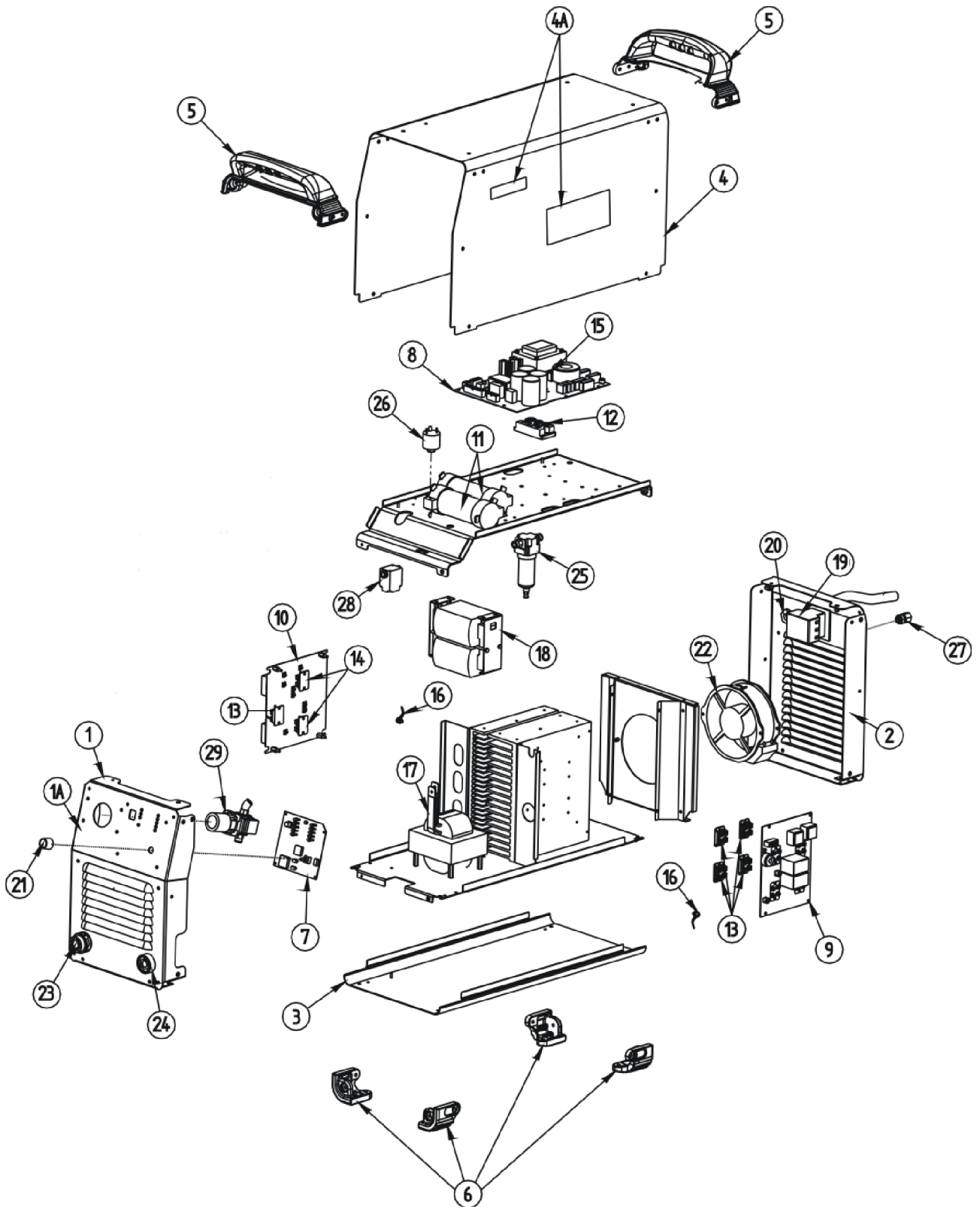

Figure B

**Figure B: Machine Assembly**

Item	Description	Part Number	QTY	1	2	3	4	5	6	7
1	FRONT FRAME	W93X1151R	1	X						
1A	+ FRONT NAMEPLATE	+ W07X1053R	1	X						
2	REAR FRAME	W93X1152R	1	X						
3	BOTTOM FRAME	W93X1142R	1	X						
4	WRAPAROUND	W93X1141R	1	X						
4A	+ KIT SIDE NAMEPLATES TOMAHAWK	+ W07X1117R	2	X						
5	FRONT / REAR HANDLE	W95X1150R	2	X						
6	KIT 4 ANTI-SLIP FOOT	W95X1147R	1	X						
7	CONTROL P.C. BOARD	W05X0859R	1	X						
8	<b>INPUT P.C. BOARD</b>	<b>W05X0855-2R</b>	<b>1</b>	<b>X</b>						
9	<b>INVERTER P.C. BOARD WITH IGBTs</b>	<b>W05X0857-2R</b>	<b>1</b>	<b>X</b>						
10	<b>OUTPUT P.C. BOARD WITH DIODEs AND IGBT</b>	<b>W05X0858-2R</b>	<b>1</b>	<b>X</b>						
11	D.C. BUS SCREW CAPACITOR	W3488222R	2	X						
12	POWER INPUT BRIDGE	W4100021R	1	X						
13	<b>POWER IGBTs</b>	<b>W43IA2210AR</b>	<b>5</b>	<b>X</b>						
14	POWER DIODEs	W4010010R	2	X						
15	AUXILIARY FUSE	W7300500R	1	X						
16	THERMOSTAT SENSOR	W9600070R	2	X						
17	OUT INDUCTOR	W58X1005R	1	X						
18	OUT TRANSFORMER	W59X1006R	1	X						
19	<b>SWITCH</b>	<b>W7511706R</b>	<b>1</b>	<b>X</b>						
20	CABLE CLAMP	W8403222R	1	X						
21	KNOB	W8700030R	1	X						
22	<b>FAN</b>	<b>W7200006R</b>	<b>1</b>	<b>X</b>						
23	TORCH SHROUD	W03X0935R	1	X						
24	DINSE CONNECTOR	W7600038R	1	X						
25	AIR FILTER	W8800200R	1	X						
26	PRESSURE SWITCH	W8800019R	1	X						
27	AIR INLET PASS-THROUGH	W8800315R	1	X						
28	SOLENOID VALVE	W8800302R	1	X						
29	PRESSURE GAUGE WITH PRESSURE REGULATOR	W8800303R	1	X						

# Electrical Schematic

CODE: 52133

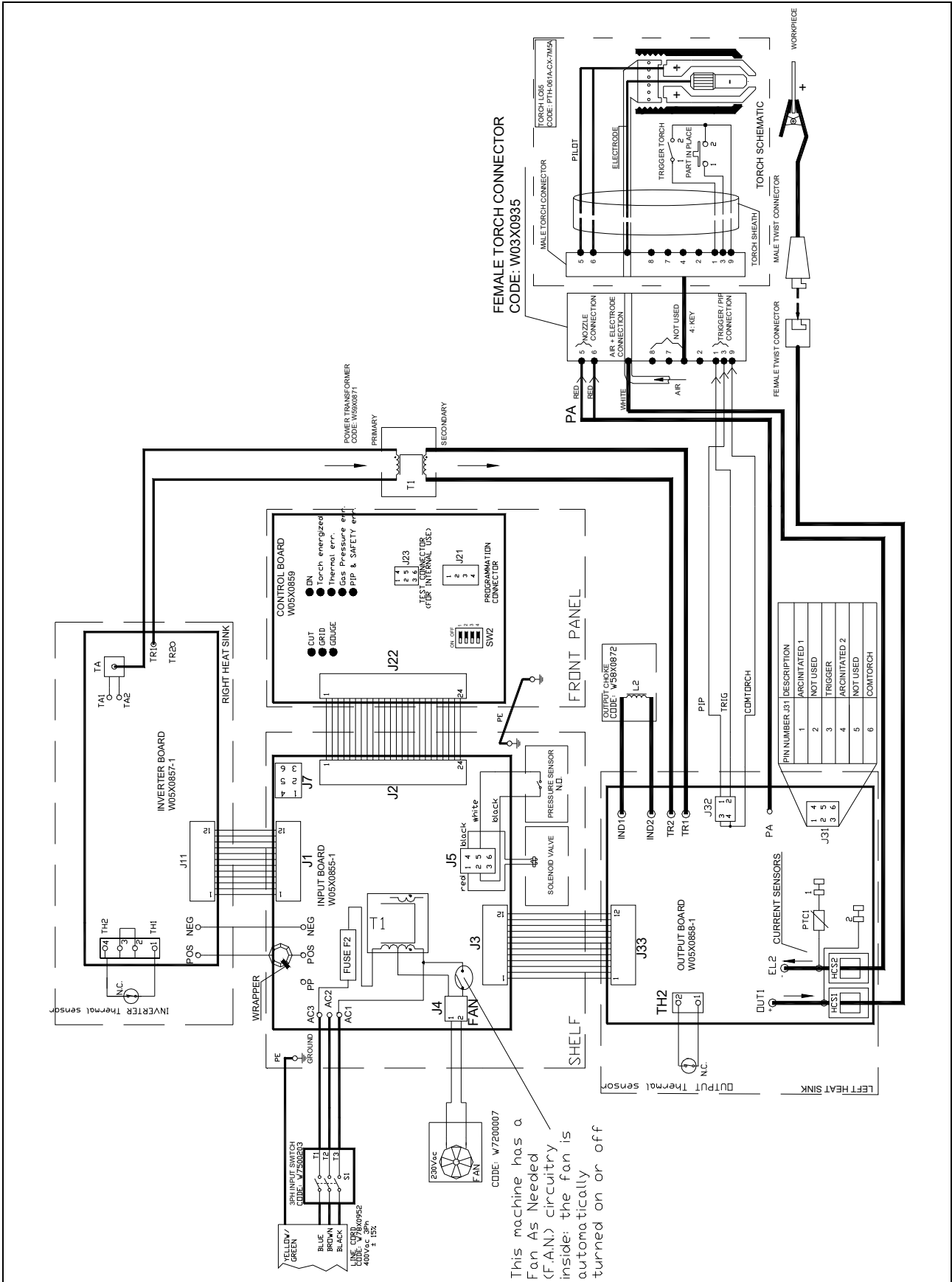

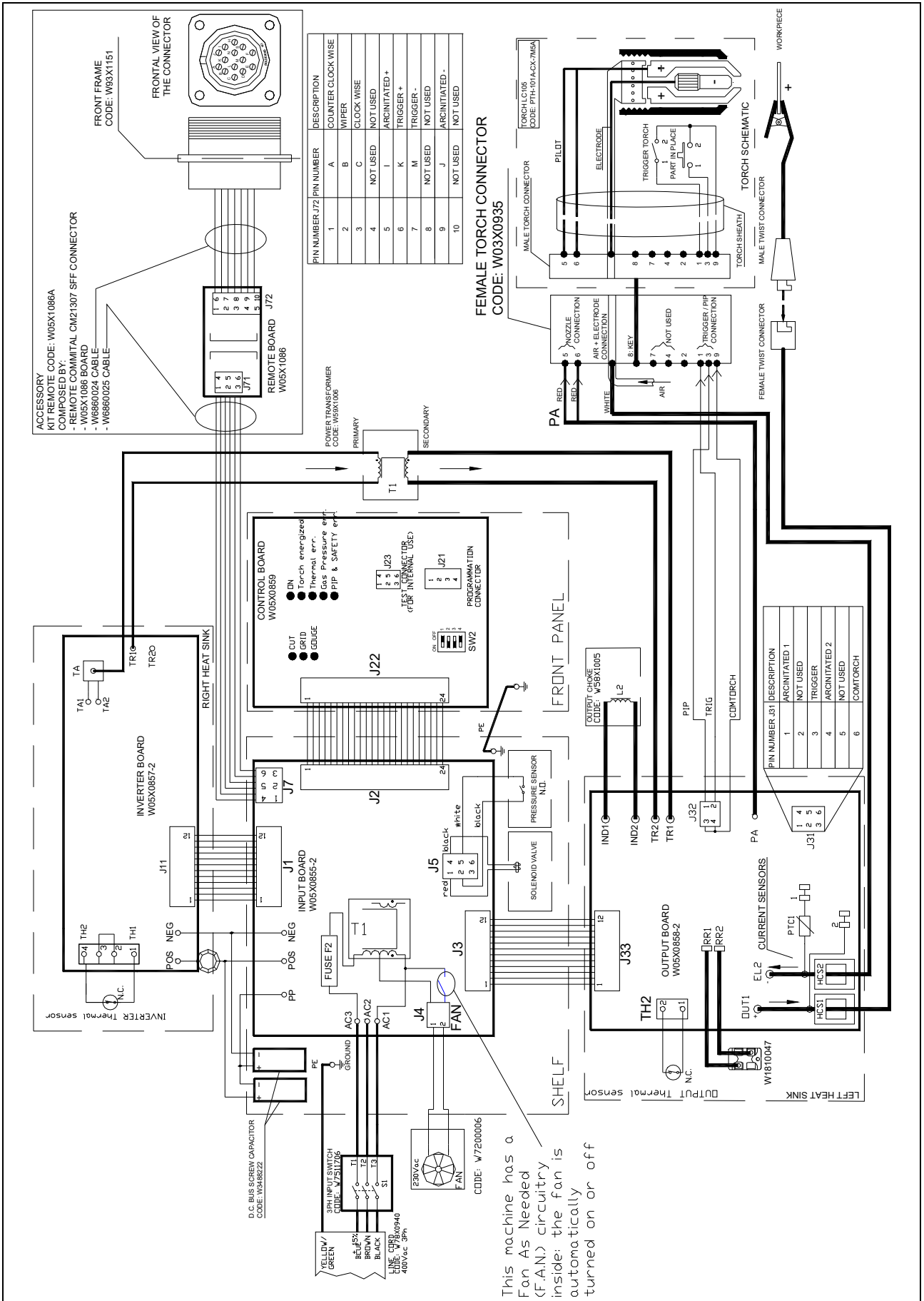

This machine has a Fan As Needed (FAN) circuitry inside: the fan is automatically turned on or off

# LC65, LC65M, LC105 & LC105M

## LC65

Torch (Hand 7.5m) (1pc)	PTH-061A-CX-7M5A
Torch (Hand 15m) (1pc)	PTH-061A-CX-15MA
Handle (1pc)	W0300609R
Head (1pc)	W0300608R

Cooling Kit (blister 1pc)	W03X0893-49R
Cable (7.5m) (1pc)	W0300604R
Cable (15m) (1pc)	W0300606R
Connector (1pc)	W03X0934-4R

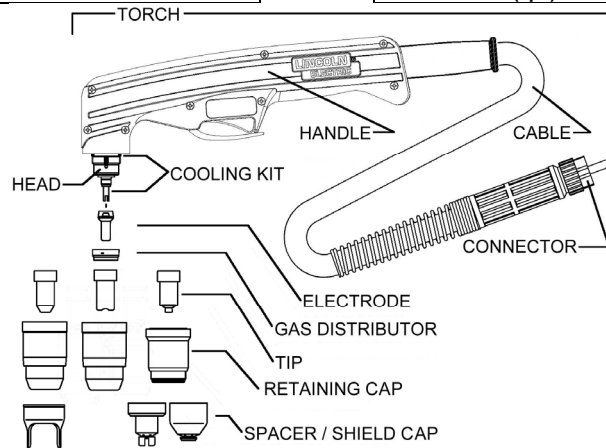

Cutting process	Electrode (blister 5pcs)		Gas Distr. (blister 3pcs)	Tip (blister 5pcs)			
40A	W03X0893-25A		W03X0893-50R	W03X0893-27A			
50A	W03X0893-25A		W03X0893-50R	W03X0893-28A			
60A	W03X0893-25A		W03X0893-50R	W03X0893-29A			
Dir Contact 40A	W03X0893-25A		W03X0893-50R		W03X0893-26A		
Contact 50A	W03X0893-25A		W03X0893-50R			W03X0893-33A	
Contact 60A	W03X0893-25A		W03X0893-50R			W03X0893-34A	
Ext Contact 40A		W03X0893-53A	W03X0893-50R				W03X0893-40A
Ext Contact 60A		W03X0893-53A	W03X0893-50R				W03X0893-54A
Gouging	W03X0893-25A		W03X0893-50R			W03X0893-39A	

Cutting process	Retaining Cap (blister 1pc)		Spacer (blister 2pcs)	Shield Cap (blister 2pcs)		
40A	W03X0893-41A		W03X0893-14R			
50A	W03X0893-41A		W03X0893-14R			
60A	W03X0893-41A		W03X0893-14R			
Dir Contact 40A	W03X0893-41A					
Contact 50A		W03X0893-43A		W03X0893-44A		
Contact 60A		W03X0893-43A		W03X0893-44A		
Ext Contact 40A		W03X0893-43A			W03X0893-21A	
Ext Contact 60A		W03X0893-43A			W03X0893-21A	
Gouging		W03X0893-43A				W03X0893-48A









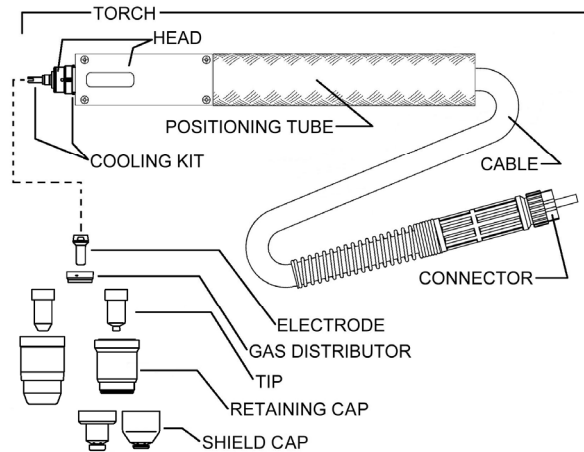

# LC65M, LC65M GEAR RACK

	LC65M	LC65M GEAR RACK
Torch (Machine 7.5m) (1pc)	PTM-061A-CX-7M5A	PTR-061A-CX-7M5A
Torch (Machine 15m) (1pc)	PTM-061A-CX-15MA	PTR-061A-CX-15MA
Positioning tube (1pc)	W0300603R	W0300624R

Head (1pc)	W0300610R
Cooling Kit (blister 1pc)	W03X0893-49R
Cable (7.5m) (1pc)	W0300605R
Cable (15m) (1pc)	W0300607R
Connector (1pc)	W03X0934-4R



Cutting process	Electrode (blister 5pcs)	Gas Distr. (blister 3pcs)	Tip (blister 5pcs)	
				
40A	W03X0893-25A	W03X0893-50R	W03X0893-27A	
50A	W03X0893-25A	W03X0893-50R	W03X0893-28A	
60A	W03X0893-25A	W03X0893-50R	W03X0893-29A	
Shielded 40A	W03X0893-25A	W03X0893-50R		W03X0893-52A
Shielded 50A	W03X0893-25A	W03X0893-50R		W03X0893-33A
Shielded 60A	W03X0893-25A	W03X0893-50R		W03X0893-34A
Gouging	W03X0893-25A	W03X0893-50R		W03X0893-39A

Cutting process	Retaining Cap (blister 1pc)		Shield Cap (blister 2pcs)	
				
40A	W03X0893-41A			
50A	W03X0893-41A			
60A	W03X0893-41A			
Shielded 40A		W03X0893-43A	W03X0893-46A	
Shielded 50A		W03X0893-43A	W03X0893-46A	
Shielded 60A		W03X0893-43A	W03X0893-46A	
Gouging		W03X0893-43A		W03X0893-48A

# LC105

Torch (Hand 7.5m) (1pc)	PTH-101A-CX-7M5A
Torch (Hand 15m) (1pc)	PTH-101A-CX-15MA
Handle (1pc)	W0300609R
Head (1pc)	W0300618R

Insulation Kit (blister 1pc)	W03X0893-71R
Cable (7.5m) (1pc)	W0300620R
Cable (15m) (1pc)	W0300621R
Connector (1pc)	W03X0934-8R

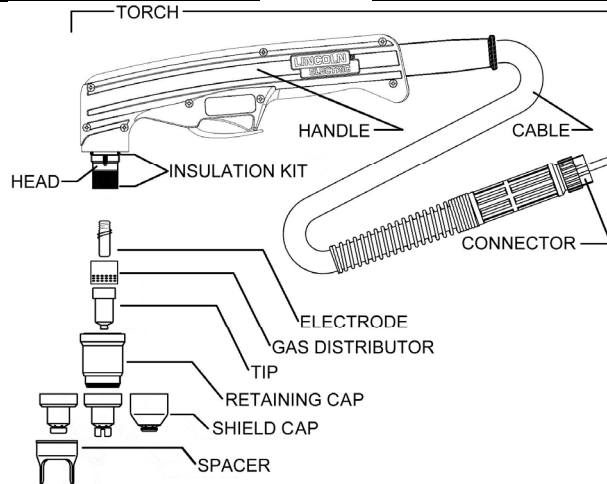

	Electrode (blister 5pcs)		Gas Distr. (blister 2pcs)	Tip (blister 5pcs)	
<b>Cutting process</b>					
40A	W03X0893-60A		W03X0893-70R	W03X0893-61A	
60A	W03X0893-60A		W03X0893-70R	W03X0893-62A	
80A	W03X0893-60A		W03X0893-70R	W03X0893-63A	
100A	W03X0893-60A		W03X0893-70R	W03X0893-64A	
Contact 40A	W03X0893-60A		W03X0893-70R	W03X0893-61A	
Contact 60A	W03X0893-60A		W03X0893-70R	W03X0893-62A	
Contact 80A	W03X0893-60A		W03X0893-70R	W03X0893-63A	
Contact 100A	W03X0893-60A		W03X0893-70R	W03X0893-64A	
Ext Contact 40A		W03X0893-57A	W03X0893-70R		W03X0893-58A
Ext Contact 60A		W03X0893-57A	W03X0893-70R		W03X0893-59A
Ext Contact 80A		W03X0893-57A	W03X0893-70R		W03X0893-72A
Ext Contact 100A		W03X0893-57A	W03X0893-70R		W03X0893-73A
Gouging	W03X0893-60A		W03X0893-70R	W03X0893-65A	



	Retaining Cap (blister 1pc)	Spacer (blister 2pcs)	Shield Cap (blister 2pcs)			
<b>Cutting process</b>						
40A	W03X0893-66A	W03X0893-14R	W03X0893-68A			
60A	W03X0893-66A	W03X0893-14R	W03X0893-68A			
80A	W03X0893-66A	W03X0893-14R	W03X0893-68A			
100A	W03X0893-66A	W03X0893-14R	W03X0893-68A			
Contact 40A	W03X0893-66A			W03X0893-67A		
Contact 60A	W03X0893-66A			W03X0893-67A		
Contact 80A	W03X0893-66A			W03X0893-67A		
Contact 100A	W03X0893-66A			W03X0893-67A		
Ext Contact 40A	W03X0893-66A				W03X0893-74A	
Ext Contact 60A	W03X0893-66A				W03X0893-74A	
Ext Contact 80A	W03X0893-66A				W03X0893-74A	
Ext Contact 100A	W03X0893-66A				W03X0893-74A	
Gouging	W03X0893-66A					W03X0893-69A

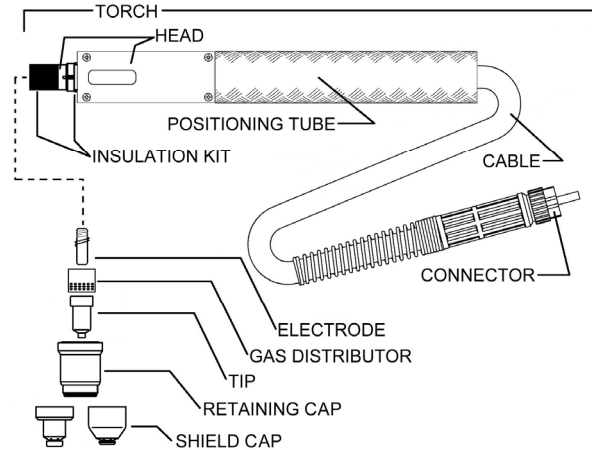

# LC105M, LC105M GEAR RACK

	LC105M	LC105M GEAR RACK
Torch (Machine 7.5m) (1pc)	PTM-101A-CX-7M5A	PTR-101A-CX-7M5A
Torch (Machine 15m) (1pc)	PTM-101A-CX-15MA	PTR-101A-CX-15MA
Positioning tube (1pc)	W0300603R	W0300624R

Head (1pc)	W0300619R
Insulation Kit (blister 1pc)	W03X0893-71R
Cable (7.5m) (1pc)	W0300622R
Cable (15m) (1pc)	W0300623R
Connector (1pc)	W03X0934-8R



	Electrode (blister 5pcs)	Gas Distr. (blister 2pcs)	Tip (blister 5pcs)
<b>Cutting process</b>			
<b>40A</b>	W03X0893-60A	W03X0893-70R	W03X0893-61A
<b>60A</b>	W03X0893-60A	W03X0893-70R	W03X0893-62A
<b>80A</b>	W03X0893-60A	W03X0893-70R	W03X0893-63A
<b>100A</b>	W03X0893-60A	W03X0893-70R	W03X0893-64A
<b>Gouging</b>	W03X0893-60A	W03X0893-70R	W03X0893-65A

	Retaining Cap (blister 1pc)	Shield Cap (blister 2pcs)
<b>Cutting process</b>		 
<b>40A</b>	W03X0893-66A	W03X0893-68A
<b>60A</b>	W03X0893-66A	W03X0893-68A
<b>80A</b>	W03X0893-66A	W03X0893-68A
<b>100A</b>	W03X0893-66A	W03X0893-68A
<b>Gouging</b>	W03X0893-66A	W03X0893-69A

**LC65 & LC105 Circle Kit (optional)**

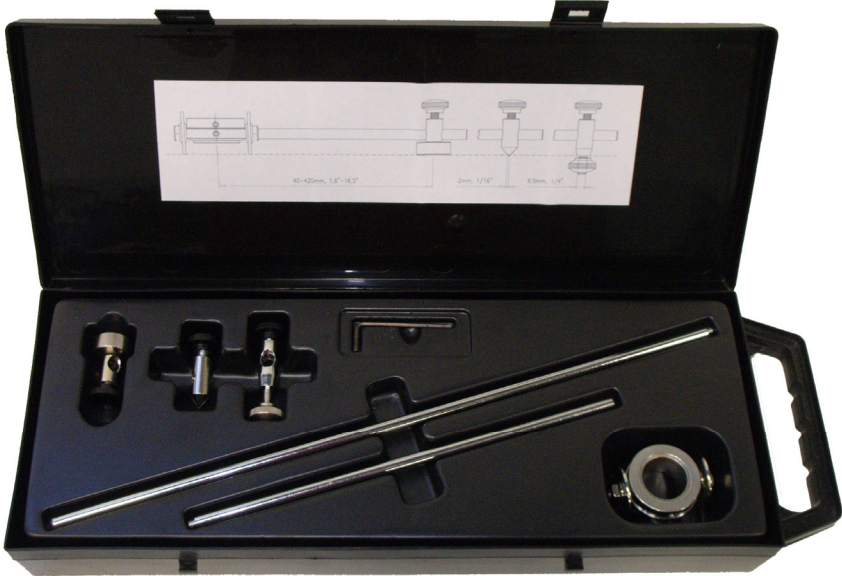

W0300699A LC Circle Kit (optional)

# Torches Dimensions

