

SWITCHBOARD

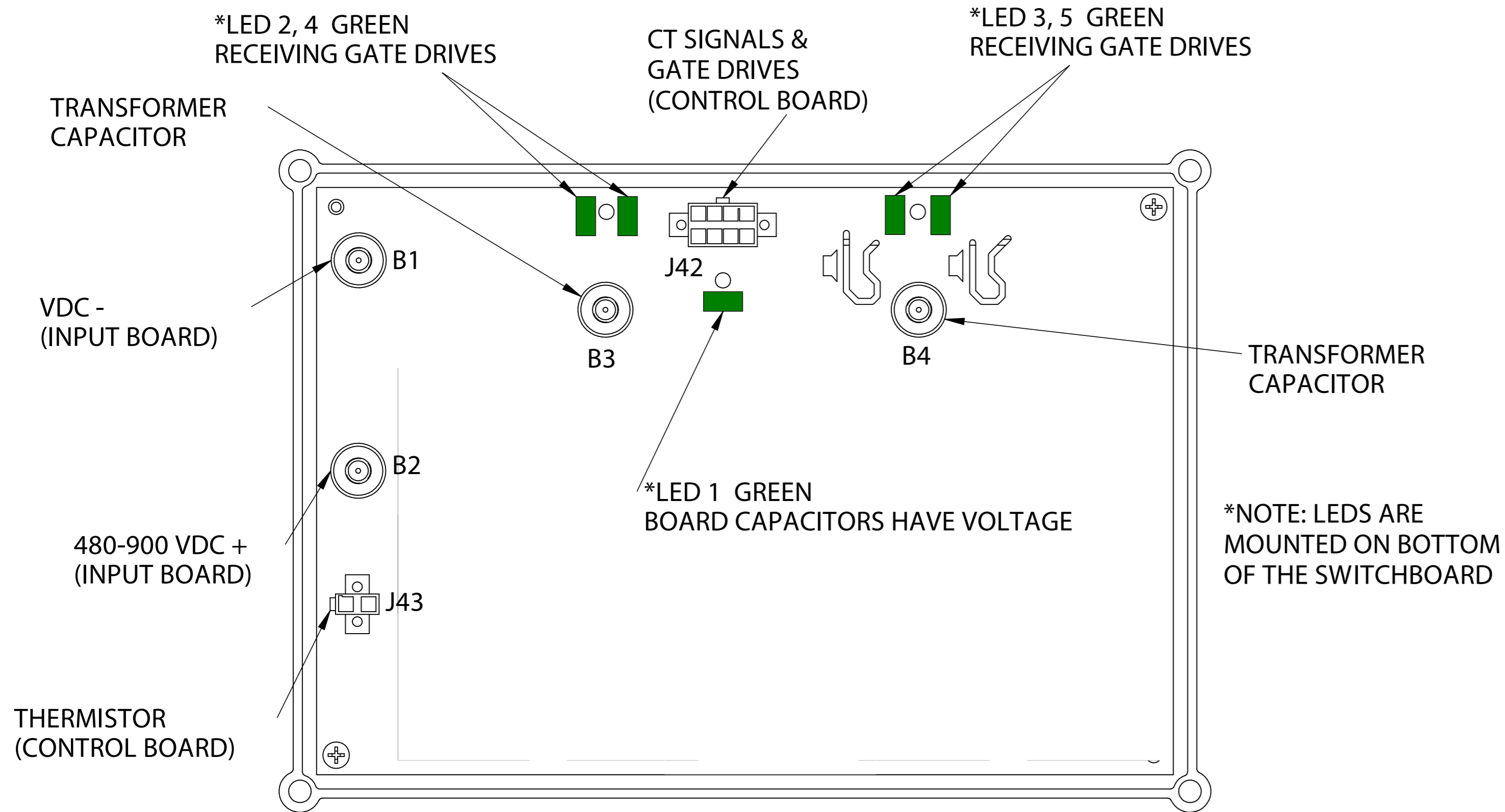

INPUT P.C. BOARD

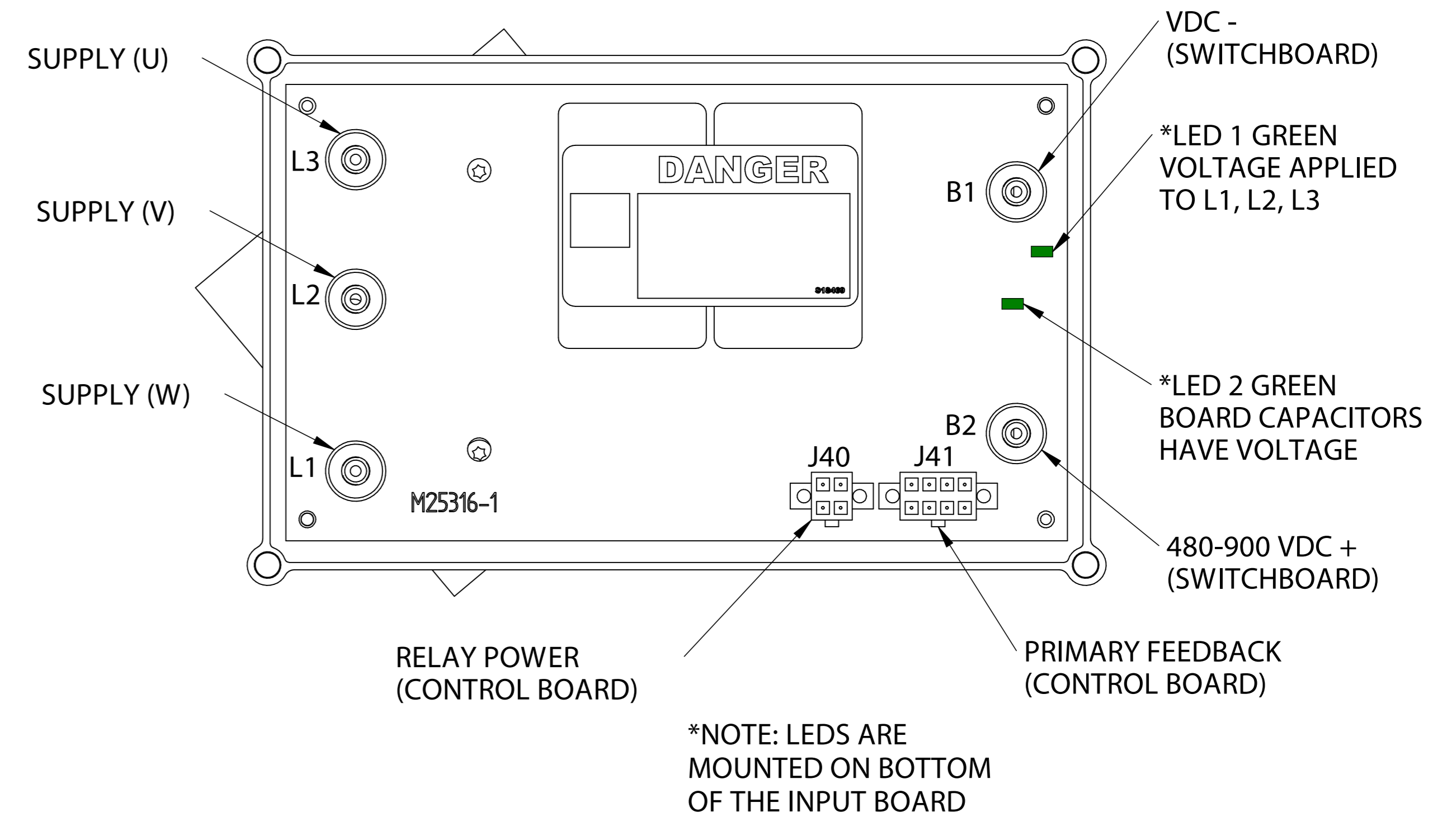

CONTROL BOARD

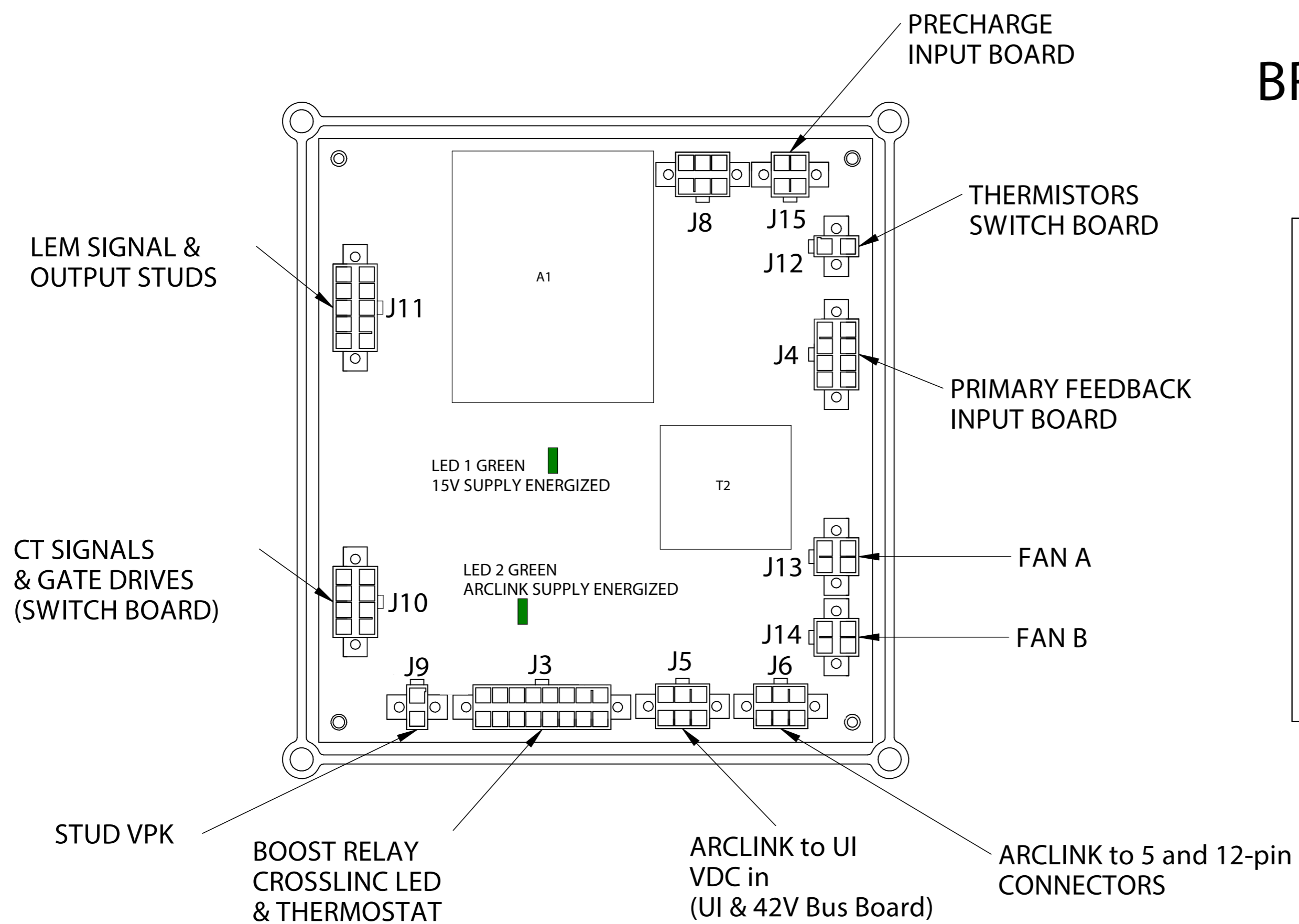

BRAIN BOARD (A1)

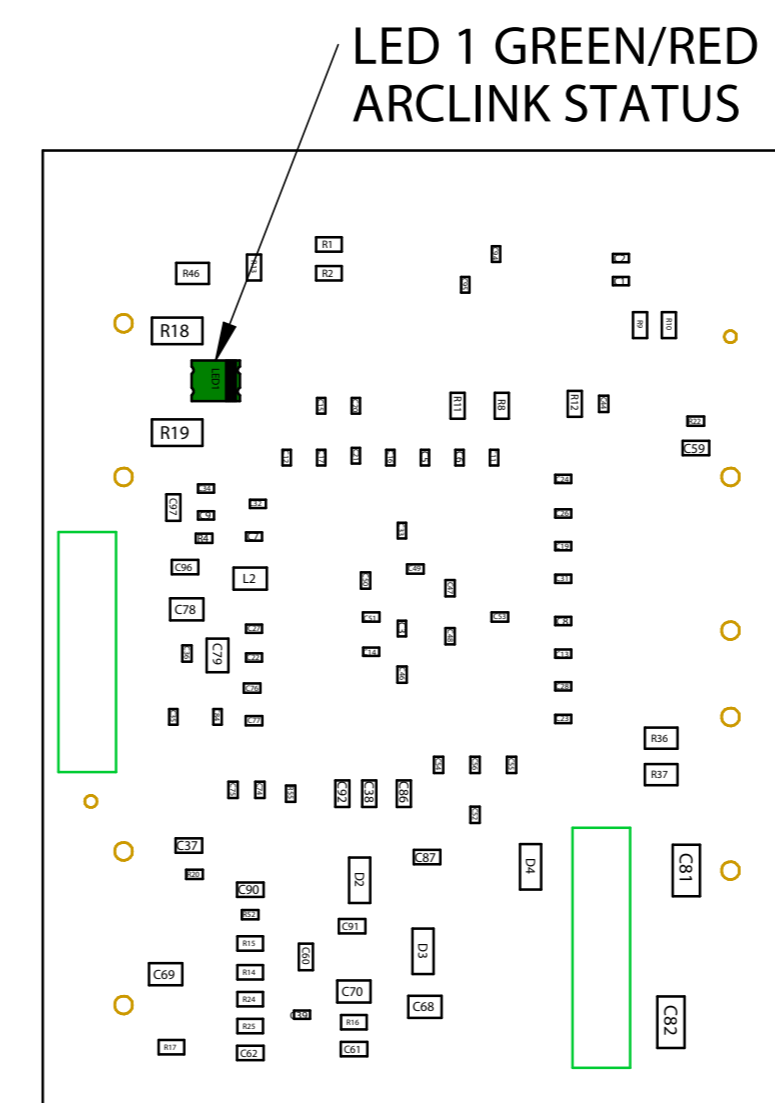

2:1

42V DC BUS BOARD

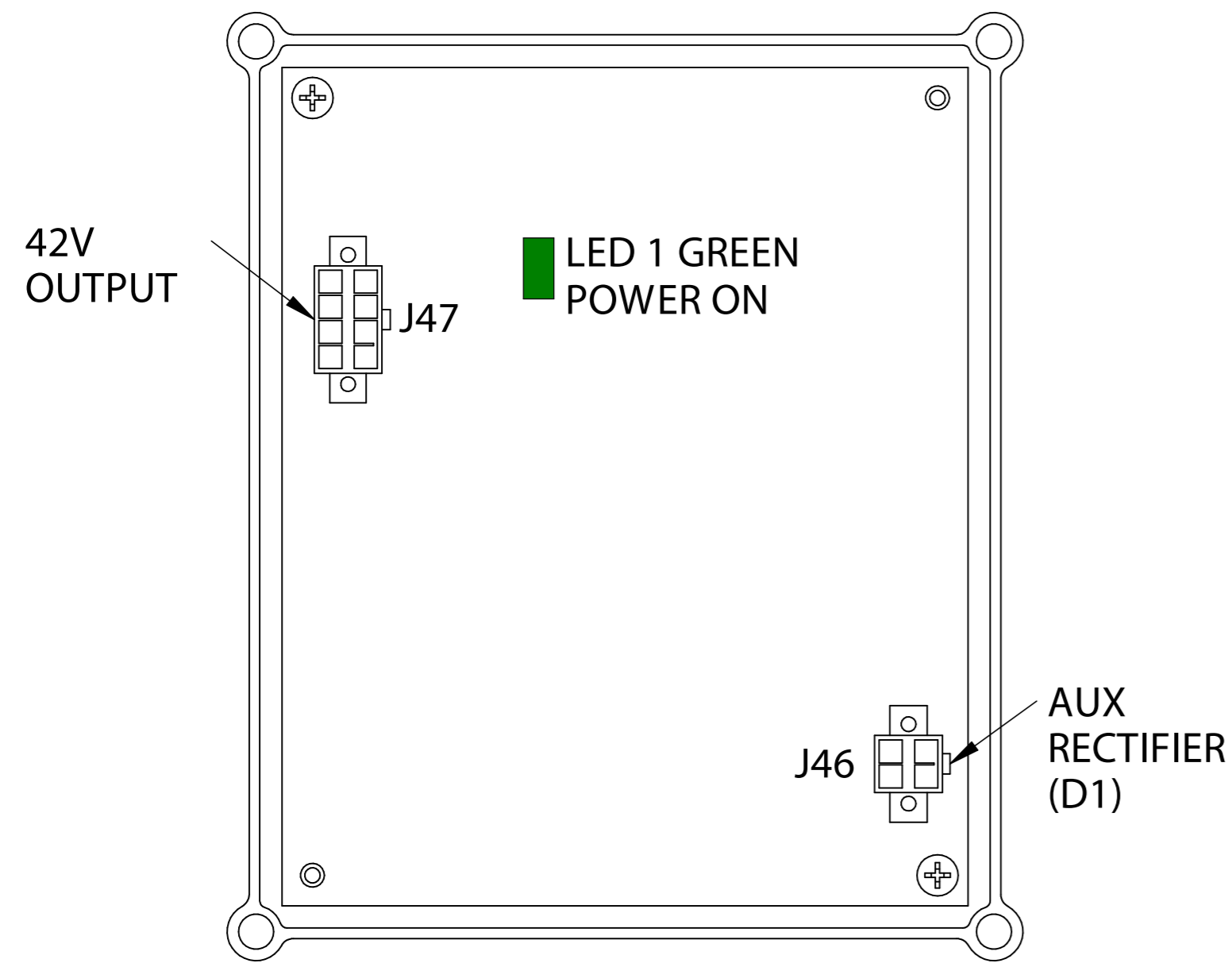

USER INTERFACE BOARD (FRONT)

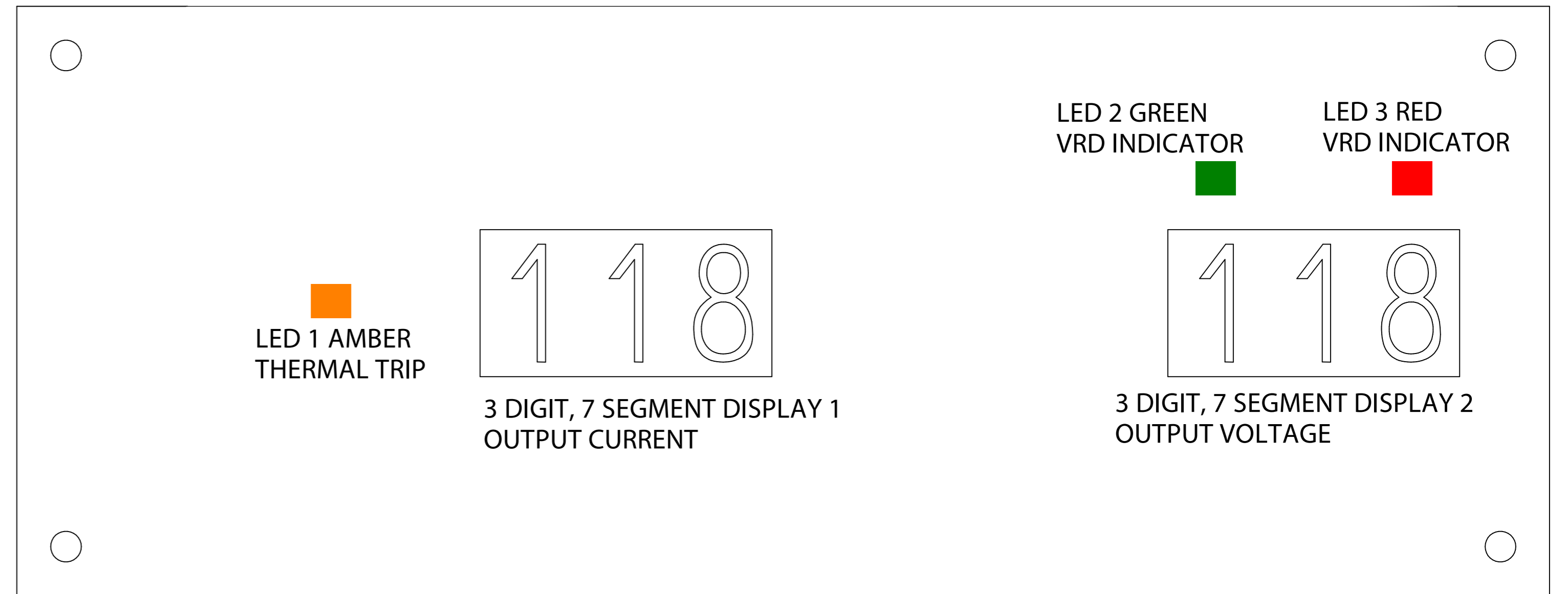

USER INTERFACE BOARD (BACK)

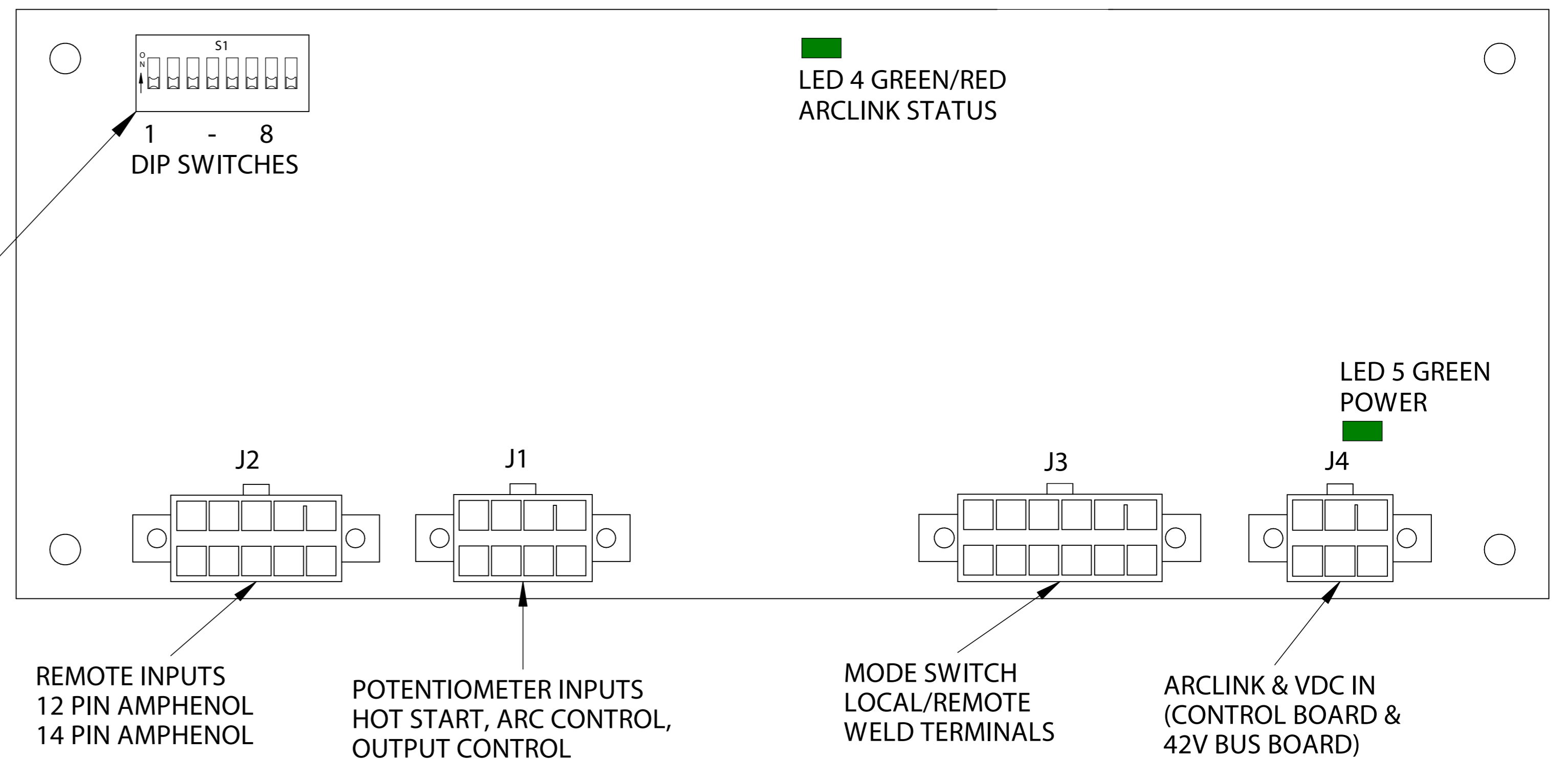

DIP SWITCH FUNCTIONS

SWITCH	FUNCTION	DEFAULT
1	CALIBRATION MODE	OFF
2	NOT USED	OFF
3	NOT USED	OFF
4	CC (MODE 200) & CV (MODE 201) TEST MODES	OFF
5	VRD	OFF
6	NOT USED	OFF
7	NOT USED	OFF
8	FRONT PANEL CHECK, SOFTWARE VERSION, & ERROR LOGS	OFF