



# FUME REDUCTION & EXTRACTION SOLUTIONS

[www.lincolnelectric.eu](http://www.lincolnelectric.eu)

**LINCOLN**<sup>®</sup>  
**ELECTRIC**



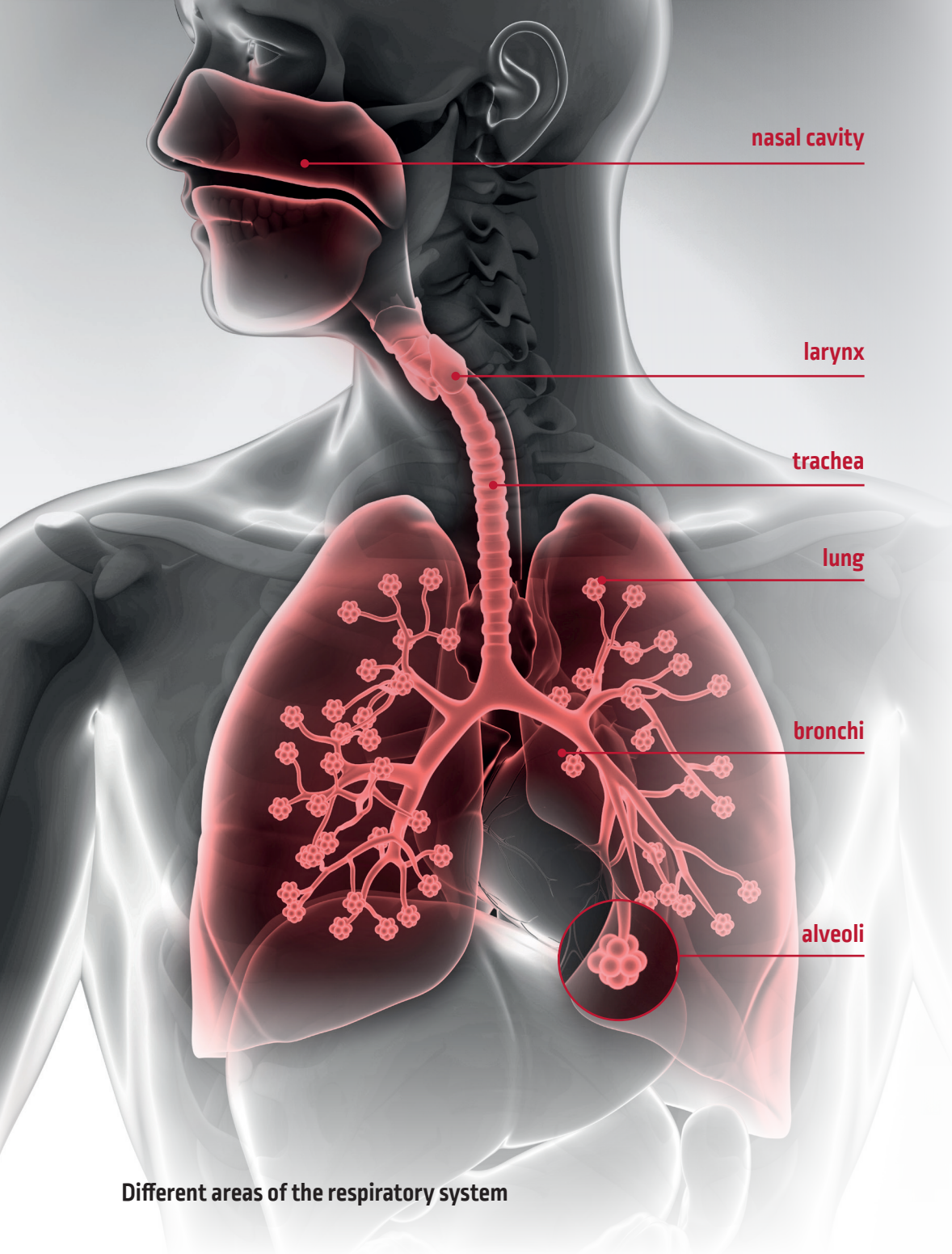

Different areas of the respiratory system

## IMPACT OF WELDING FUMES ON YOUR RESPIRATORY SYSTEM

### Inhalable, thoracic and respirable fractions

The respiratory system may be divided into three areas: upper airways, the tracheobronchial tree and the alveolar region.

Based on that division, three particle fractions have been defined according to their size, namely inhalable, thoracic and respirable fractions [according to standard AFNOR EN 481]. These provide indications about the penetration and settlement of particles in the respiratory system and their potential effects on health.

- Inhalable fraction: mass fraction of airborne particles that can enter the body through the mouth and nose and settle in the respiratory tract; it includes particles with an aerodynamic diameter<sup>1</sup> up to 100  $\mu\text{m}$ .
- Thoracic fraction: mass fraction of particles which, once inhaled, can pass beyond the larynx; it includes particles with an aerodynamic diameter up to 30  $\mu\text{m}$ .
- Respirable fraction: mass fraction of particles which, once inhaled, can reach the pulmonary alveoli; it includes particles with an aerodynamic diameter up to 10  $\mu\text{m}$ .

As particles emitted during welding and cutting work have an aerodynamic diameter below 1  $\mu\text{m}$ , the respirable fraction plays a central role from the viewpoint of the effects on health. Data about inhalable dust generally lead to an overestimation of exposure rather than an underestimation.

1. The aerodynamic diameter of a particle is the diameter of a spherical particle with a density of  $10^3 \text{ kgm}^{-3}$  and the same terminal velocity in undisturbed air as a particle in the same conditions of pressure, temperature and relative humidity. The aerodynamic diameter simultaneously refers to the size of the particle (and therefore its geometric dimensions), and its shape and density.

Source: Guide INRS ED 6132 welding fumes risk

## CLEAROSTA® STAINLESS STEEL RANGE

How can I reduce CrVI in welding fume? CLEAROSTA consumables reduce the CrVI emission rate. Use of CLEAROSTA products in conjunction with a fume control strategy to minimize worker exposure to CrVI in welding fume.



[THE BROCHURE](#)

### Comparative fume characteristics

Results generated by TWI (The Welding Institute Ltd), Cambridge UK, June 2016.

- Emission rate testing according to ISO 15011-1,4
- Fumes analysis according to ISO 16740:2005
- Welding performed with an inverter on degreased stainless steel (AISI 304)
- Welding conditions:
  - > Electrode: 115 A - 29V
  - > Flux cored wire: 200 A - 28V
  - > Shielding gas: M21
- A reduction up to -40% is also observed for fume rate using CLEAROSTA range
- Comparable results in fume emission and CrVI concentration between 308L, 316L and 309L

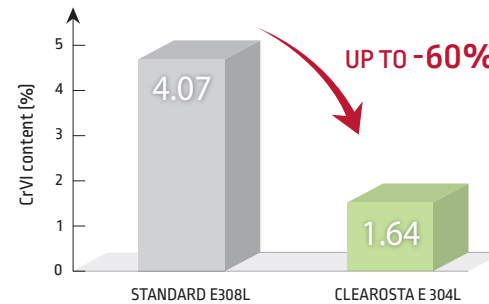

CrVI concentration - MMA  
CLEAROSTA E vs Standard 308L

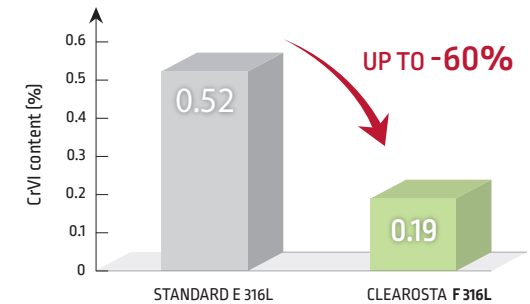

CrVI concentration - FCAW  
CLEAROSTA F vs Standard 316L

### ORDERING INFORMATION



PRODUCT NAME	Ø (mm)	LENGTH (mm)	QUANTITY		ITEM NUMBER
			PER PACK	PER BOX	
CLEAROSTA E 304L	2.5	300	90	540	710001
	3.2	350	55	330	710002
	4	350	40	240	710003
	5	350	20	120	710004
CLEAROSTA E 316L	2.5	300	90	540	710009
	3.2	350	55	330	710010
	4	350	40	240	710011
	5	350	20	120	710012
CLEAROSTA E 309L	2.5	300	90	540	710005
	3.2	350	55	330	710006
	4	350	40	240	710007
	5	350	20	120	710008

### ORDERING INFORMATION



PRODUCT NAME	AWS A5.22	ISO 17633	Ø (mm)	WEIGHT (kg)	REFERENCE
CLEAROSTA F 304L	E308LT1-1 E308LT1-4	17633-A: T 19 9 L P C 1	1.2	15	710013
		17633-A: T 19 9 L P M 1			
		17633-B: TS308L-FB1			
CLEAROSTA F 316L	E316LT1-1 E316LT1-4	17633-A: T 19 12 3 L P C 1	1.2	15	710015
		17633-A: T 19 12 3 L P M 1			
		17633-B: TS316L-FB1			
CLEAROSTA F 309L	E309LT1-1 E309LT1-4	17633-A: T 23 12 L P C 1	1.2	15	710014
		17633-A: T 23 12 L P M 1			
		17633-B: TS309L-FB1			

## OUTERSHIELD® MC710RF-H

To help reduce your welders' exposure to fume

### Productivity

- Very good mechanical properties [CVN >47] at -30°C

### Lower Fume Emission Rate

- 24% reduction in Fume Emission Rate (FER) comparing to Outershield® MC710-H
- FER : between 6 and 8 mg/s at most popular industrial welding parameters



 GET MORE DETAILS

### ORDERING INFORMATION

PRODUCT NAME	ITEM NUMBER	Ø (mm)	WEIGHT & CONDITIONING
OUTERSHIELD® MC710RF-H	901307	1.2	5 kg S200 SPOOL - AL BAG
	901300	1.2	16 kg B300 SPOOL
	901328	1.4	16 kg B300 SPOOL
	901314	1.6	16 kg B300 SPOOL

# ONE OF THE LOWEST FUME GENERATING METAL CORED WIRES IN ITS CLASS

### FUME EMISSION LEVEL (MG/S)

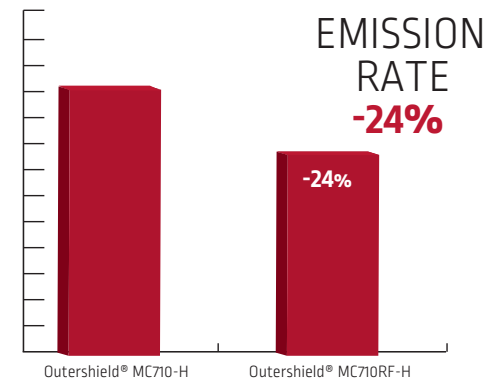
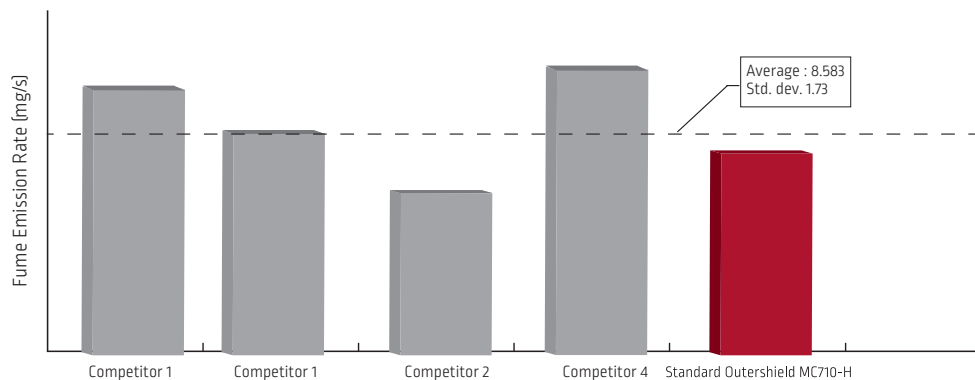

PERFORMANCE  
SIMILAR IN PA/PB/1F/1G &  
BETTER IN POSITIONAL  
WELDING



## LOW FUME PULSE™

A BETTER WELD. A BETTER WORK ENVIRONMENT



THE BROCHURE

### The Win-Win Solution

Lincoln Electric's Low Fume Pulse™ simplifies the balancing act between weld fume control and weld floor productivity. Developed to be a win-win solution, this advanced welding process combines maximum weld performance with low fume generation, allowing you to improve operator productivity and safety at the same time.

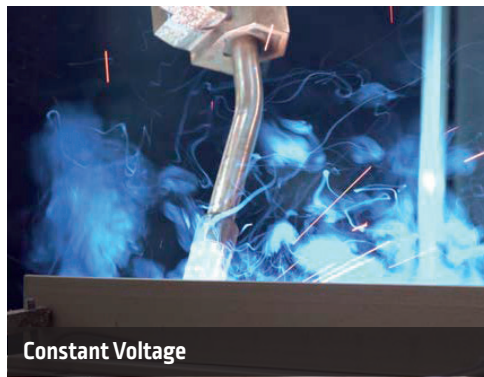

Constant Voltage

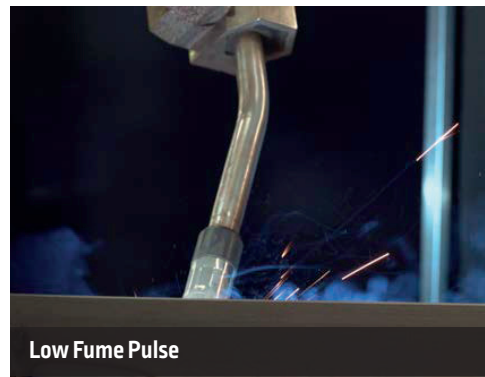

Low Fume Pulse

Process comparison: CV versus Low Fume Pulse using the same wire diameter, wire feed speed, and contact tip to work distance.

### Reduction at the Source

Unlike traditional Constant Voltage (CV) MIG, Low Fume Pulse utilizes patented Waveform Control Technology® for advanced arc performance, minimizing heat input and reducing weld fume generation directly at the arc.

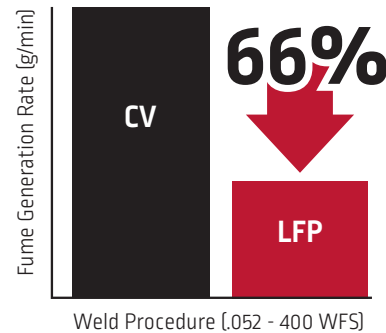

### The Starting Point of Fume Control

Engineered to be the first step to overall weld fume control, Low Fume Pulse allows you to control weld fumes right from the start, limiting the actual volume of weld fumes generated within the welding environment prior to entering additional stages of ventilation and extraction.



EQUIPMENT	WELD PROCESS*	ADDITIONAL WELD FUME CONTROL
Power Wave® 300C Advance, R450 with STT® Module or Advance Module	Low Fume Pulse	Local Extraction Units General Filtration Solutions On Torch
Power Feed® 84		

\* Available as a FREE weld set update for current Power Wave S500 owners. Download at [www.powerwavesoftware.com](http://www.powerwavesoftware.com)







## ZEPHYR LS / FLIPAIR LS

Bring the fume protection and filtered air directly to the operator working in difficult conditions.

- Large viewing area of 5 820 mm<sup>2</sup>.
- Lense switching speed: 0.04 ms.
- Four arc sensors.
- DIN 3/5-13.
- INFOTRACK & X-mode.
- Helmet with powered and filtered airflow.
- ZEPHIR LS: Grinding mode with external button.
- FLIPAIR LS: FLIP UP version.
- Flip-up LCD filter for grinding (Flipair LS).
- The ultimate welder protection.
- Delivered in a rugged carry bag with accessories.



THE BROCHURE

### Processes

Stick, TIG, Pulsed TIG, MIG, Pulsed MIG, Flux-Cored, Gouging, Plasma Cutting, Grinding

### Reference

Zephyr LS Helmet	W000403674
Zephyr LS LCD cell	W000402681
Flipair LS Helmet	W000403675
Flipair LS LCD cell	W000402682



## EUROPURE PLUS 5500 – TH3 PAPR

Powered Air Purifying Respirator TH3 Class



### Reference

W403676

### Features PAPR

- 5-6 hours working / 9-15 Extended battery
- 1 Hour Battery Charge
- Auto-alarm System
- Real-time Display Indicator
- Filter Efficiency ≥ 99.97%

Multi-layer filtration with particle box filtration provides efficiency of up to 99.99%. The TH3 filtration prevents siphoning in toxic particles, soot and other contaminants for a safe and refreshing breathing experience.

### Features ADF

- Optical class: 1/1/1
- Viewing area: 8 025 mm<sup>2</sup>
- Lens shade: 3.5/8-13
- Independent sensors: 4
- TIG Amp rating: ≥ 2A DC & ≤ 2A AC







# LOW VACUUM



# LOW-VACUUM PROCESS

Example of low-vacuum equipment:

- A** Digifilter
- B** Extraction panel
- C** Extraction arm
- D** Work table
- E** Extraction hood
- F** Down-draft table
- G** Down-draft work table
- H** Heavy-duty down-draft table
- I** Down-draft cutting table

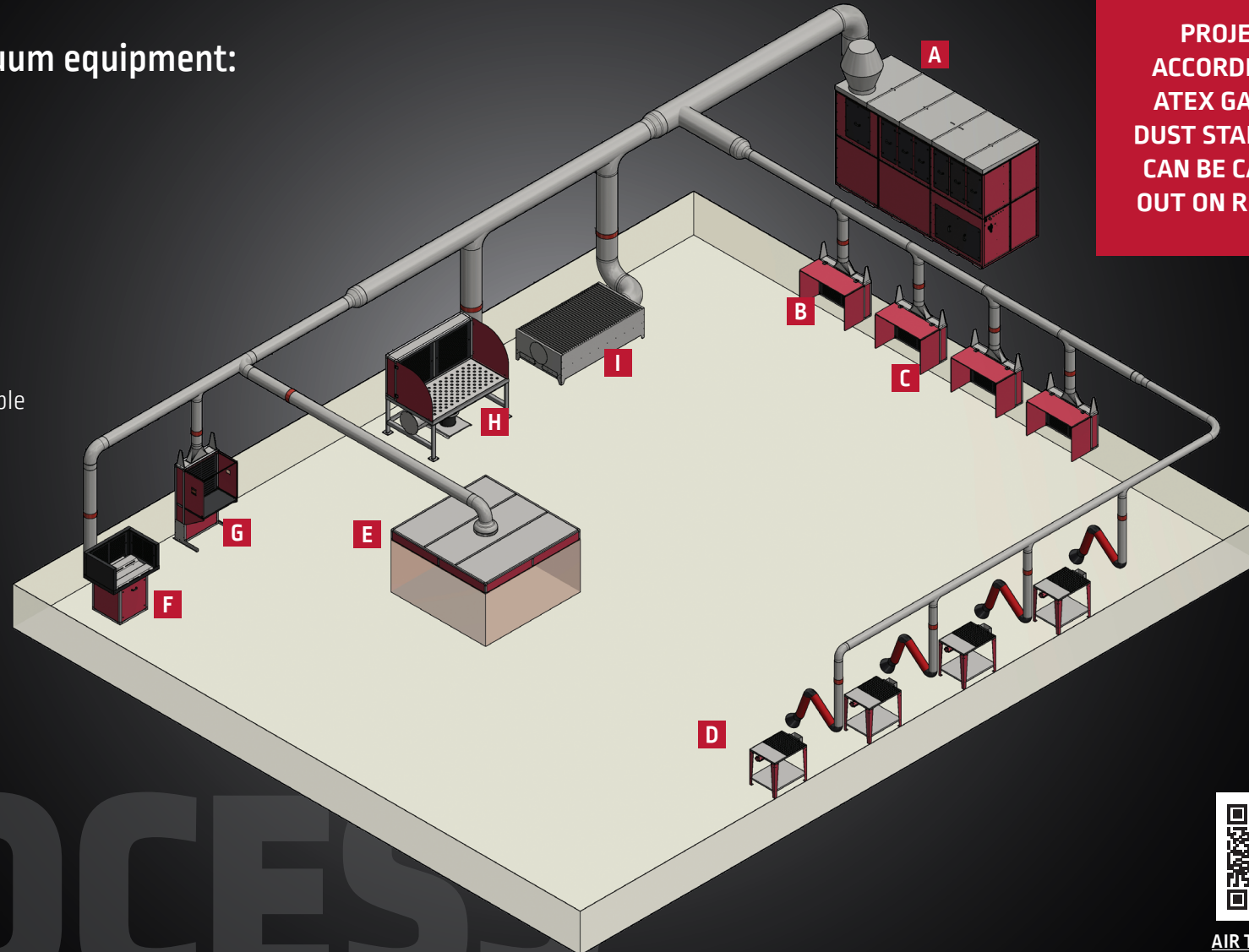

**PROJECTS  
ACCORDING TO  
ATEX GAS AND  
DUST STANDARDS  
CAN BE CARRIED  
OUT ON REQUEST**



**AIR TREATMENT  
CATALOGUE**

## LOW VACUUM CENTRAL UNITS

Applications dedicated chiefly to welding, cutting, grinding and sanding: Digifilter is suitable for all non-explosive dry dust and fumes.

### Specifications:

- High-efficiency self-cleaning filter.
- PLC management with remote control with a 5.7" touch screen HMI.
- High-efficiency backward centrifugal fan. Class EU2 metal pre-filter.
- Polyester medium filter cartridges with high-efficiency PTFE membrane, class H13.
- 40-litre drum(s) for dust recovery.
- Duct silencing to limit noise to 75 dB(A) from 1 metre.
- Rugged filter structure made in epoxy painted galvanised metal.

### Description of HMI functions

- Operating modes: manual/automatic/clock.
- Dynamic mode display of unit operating status.
- Threshold-based or continuous cleaning of filter cartridges.
- Real-time display of main parameters:
  - pressure difference of filter cartridges,
  - compressed air pressure. Weekly programming clock.
- Remote control with 15 m cable.
- Stack light showing On, Off, Safety alarm. Settings saved on USB stick.
- Filter cartridge pressure difference trend curve.
- Filter maintenance management:
  - hours of use,
  - cartridge replacement,
  - fan maintenance,
  - dust drum maintenance.



HMI home screen

### Operating principle

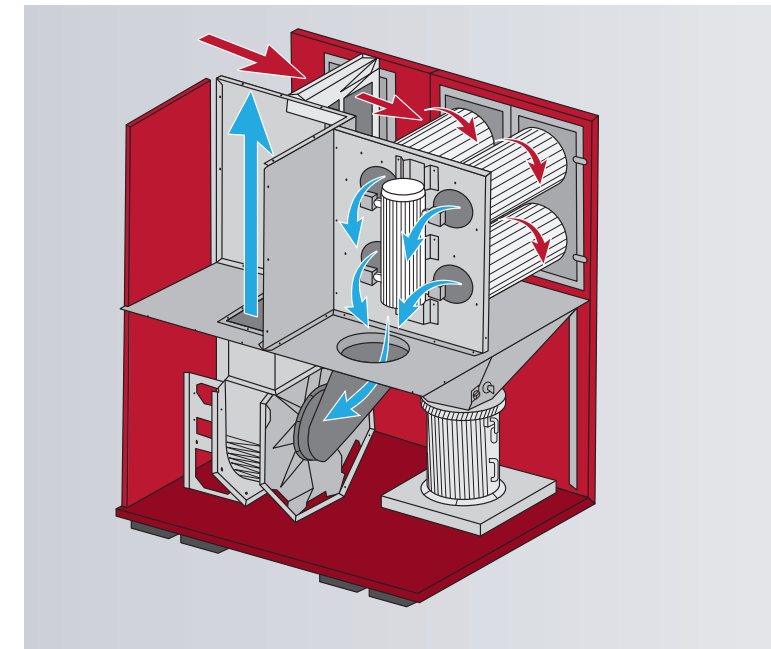
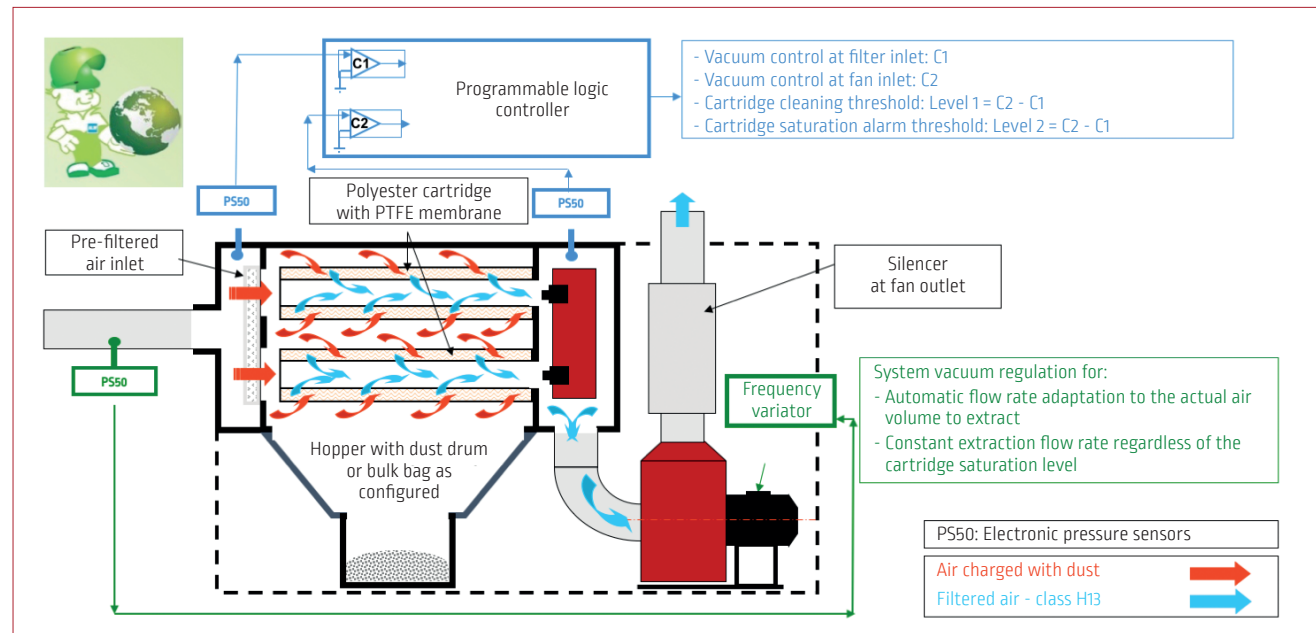



Conformity **CE**



NB: Upon request, we can also offer:

- DIGIFILTER with capacity 32,000, 40,000 and 50,000 m<sup>3</sup>/h.
- ATEX DIGIFILTER for explosive particles (zone 21 or 22 dust).

## ORDERING INFORMATION

DIGIFILTER COMPACT TYPE	PART NUMBER INLET ON THE RIGHT	PART NUMBER INLET ON THE LEFT
<b>DIGIFILTER - 2 CD</b> Operating point: 2,400 m <sup>3</sup> /h at 2,800 Pa Motor, 4 kW - 400 V - 3 Phases 2 x 15 m <sup>2</sup> filter cartridges	EM61000010	–
<b>DIGIFILTER - 4 CD</b> Operating point: 4,000 m <sup>3</sup> /h at 2,400 Pa Motor, 5.5 kW - 400 V - 3 Phases 4 x 15 m <sup>2</sup> filter cartridges	EM61000010	EM61000018
<b>DIGIFILTER - 6 CD</b> Operating point: 6,000 m <sup>3</sup> /h at 2,100 Pa Motor, 7.5 kW - 400 V - 3 Phases 6 x 15 m <sup>2</sup> filter cartridges	EM61000011	EM61000019
<b>DIGIFILTER - 8 CD</b> Operating point: 6,000 m <sup>3</sup> /h at 2,100 Pa Motor, 7.5 kW - 400 V - 3 Phases 6 x 15 m <sup>2</sup> filter cartridges	EM61000012	EM61000020
<b>DIGIFILTER - 6 CD</b> Operating point: 8,000 m <sup>3</sup> /h at 2,100 Pa Motor, 11 kW - 400 V - 3 Phases 8 x 15 m <sup>2</sup> filter cartridges	EM61000013	EM61000021
<b>DIGIFILTER - 12 CD</b> Operating point: 12,000 m <sup>3</sup> /h at 2,400 Pa Motor, 18.5 kW - 400 V - 3 Phases 12 x 15 m <sup>2</sup> filter cartridges	EM61000014	EM61000022
DIGIFILTER SEPARATE VERSION	PART NUMBER INLET ON THE RIGHT	PART NUMBER INLET ON THE LEFT
<b>DIGIFILTER - 16 CD</b> Operating point: 16,000 m <sup>3</sup> /h at 2,400 Pa Motor, 22 kW - 400 V - 3 Phases 16 x 15 m <sup>2</sup> filter cartridges	EM61000015	EM61000023
<b>DIGIFILTER - 20 CD</b> Operating point: 20,000 m <sup>3</sup> /h at 2,800 Pa Motor, 30 kW - 400 V - 3 Phases 20 x 15 m <sup>2</sup> filter cartridges	EM61000016	EM61000024
<b>DIGIFILTER - 24 CD</b> Operating point: 24,000 m <sup>3</sup> /h at 2,400 Pa Motor, 37 kW - 400 V - 3 Phases 24 x 15 m <sup>2</sup> filter cartridges	EM61000017	EM61000025

# AMSFM DOWN-DRAFT TABLE FOR WELDING AND GRINDING

The AMSFM down-draft table incorporates a fan and a fine mechanical filter. It captures fumes from all welding processes and occasional grinding work. Pollutants are captured by the work surface and 500 mm high lateral and front panels.

- Fan, 2.2 kW - 400 V - 3 phases - 50 Hz.
- Metal pre-filters - Quantity: 2  
Dimensions 610 x 610 x 24 mm (L x W x H).
- Class F8 fine filter - filter surface area 40 m<sup>2</sup>  
- Dimensions: 610 x 610 x 292 mm
- Collecting hopper with dust drum under the work surface.
- Work surface height: 920 mm.
- Complements: Wheel kit for mobile table and H13 high-performance filtration box.



AIR TREATMENT CATALOGUE

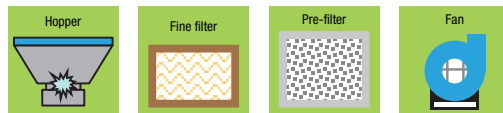

Conformity **CE**

see the full range at:

TABLE DIMENSIONS (mm)	RATE TO APPLY (m <sup>3</sup> /h)	PERMISSIBLE LOAD (kg/m <sup>2</sup> )	WORK SURFACE DIMENSIONS (mm)	OVERALL DIMENSIONS (mm)
1,200 x 800	2,000	200	1,070 x 740	1,850 x 810
2,000 x 800	3,000	200	1,870 x 740	2,000 x 810

## ORDERING INFORMATION

DESCRIPTION	PART NUMBER
AMSFM table, 1,200 x 800 mm	W000371223
AMSFM table, 2,000 x 800 mm	W000371222

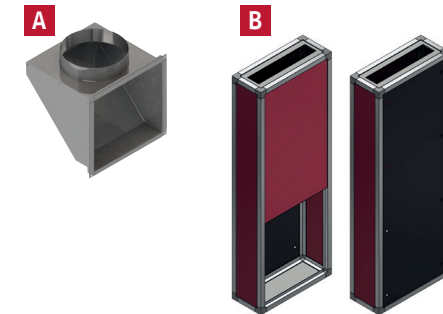

## Complements

DESCRIPTION	PART NUMBER
<b>A</b> Rear lateral or vertical outlet, Ø 250 mm	W000342588
<b>B</b> Vertical outlet with silencer box	W000273464
TRC Ø 250 mm for silencer, 1,200 x 800 table	W000380507
TRC Ø 315 mm for silencer, 2,000 x 800 table	W000380508
Wheel kit for mobile table	EM61000431
HEPA H13 filtration box	EM61000432

## Spare consumables

Metal pre-filter	W000379636
Fine filter, 42 m <sup>2</sup>	W000379637
HEPA H13 filter, 42 m <sup>2</sup>	W000373568



## MOBIFILTER 1600M

Mobifilter 1600 M is designed specially to extract and filter dry welding fumes from light or medium welding activities. It is simple to use and its large extraction capacity makes it particularly effective.

- Maximum capture rate at the arm: 1,400 m<sup>3</sup>/h.
- Cassette type mechanical filter.
- Metal pre-filter - Class EU2.
- Filter surface area 40 m<sup>2</sup> - Class F8.
- Motor 1.5 kW.
- Automatic control by the welding current.
- Vertical rear air outlet.
- Noise: 70 dB[A].
- Complements:
  - Polyarticulated or Ecoflex arm, 3 or 4 m long.
  - Outdoor discharge kit for Ø 160 mm hose.

**NB:** This type of device may not be used while welding in confined atmospheres. If it is to be used permanently, a fixed filter solution should be preferred, with a fixed collector or arm and discharge outside the building.



AIR TREATMENT  
CATALOGUE

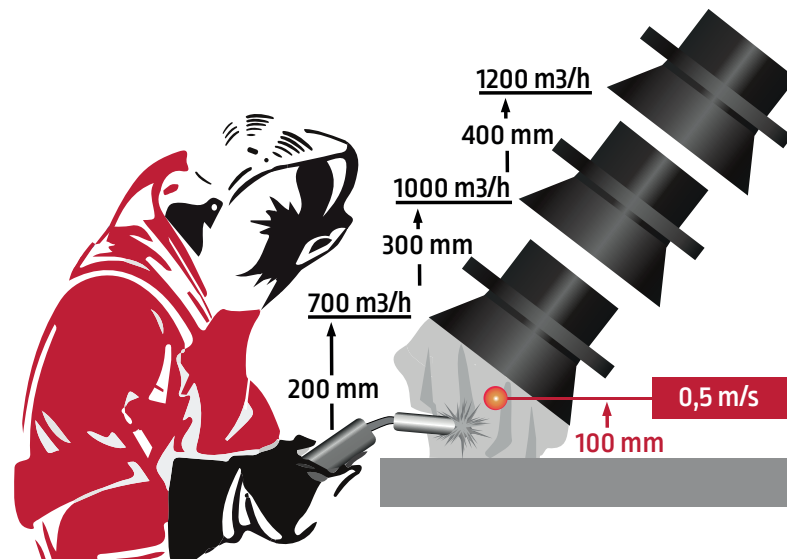

### ORDERING INFORMATION

DESCRIPTION	PART NUMBER
Mobifilter 1600M 400 V - 3 Ph - 50 Hz	W000377937
Mobifilter 1600M 230 V - 1 Ph - 50 Hz	W000377938
Mobifilter 1600M 110 V - 1 Ph - 50 Hz	W000377939

### Complement with one of the arms

3 m Ecoflex arm	W000341029
4 m Ecoflex arm	W000341031
3 m Polyarticulated arm	W000341032
4 m Polyarticulated arm	W000341033



## MOBIFLEX 200 M

Mobiflex 200 M is designed specially to extract and filter dry welding fumes from light or medium welding activities.

It is easy to use, and its high filtration capacity (50 m<sup>2</sup>) and efficiency give it a longer life.

- Maximum capture rate at the arm: 1,250 m<sup>3</sup>/h.
- Cassette type mechanical filter.
- Metal pre-filter - Class EU2.
- Filter surface area 50 m<sup>2</sup> - Class M.
- Cartridge saturation indicator.
- Motor 0.75 kW.
- Vertical air outlet.
- Noise: 69 dB(A).
- Complement:
  - 3 or 4 m long LFA arm.



Conformity **CE**

## MOBIFLEX 200 M/W3

Mobiflex 200 M/W3 has IFA W3 certification according to standard EN 15021/1.

- Maximum capture rate at the arm: 1,250 m<sup>3</sup>/h.
- Cassette type mechanical filter.
- Metal pre-filter - Class EU2.
- Mechanical filter, class MERV 16 under ASHRAE 52.2
  - Filter surface area: 50 m<sup>2</sup>.
- Cartridge saturation indicator
- Motor 0.75 kW.
- Vertical air outlet.
- Noise: 69 dB(A).



### ORDERING INFORMATION

DESCRIPTION	PART NUMBER
Mobiflex 200 M - 115 V - 1 Ph - 50 Hz*	EM7028100700
Mobiflex 200 M - 230 V - 1 Ph - 50 Hz*	EM7022110700
Mobiflex 200 M - 230 V - 3 Ph - 50 Hz*	EM7023100700
Mobiflex 200 M - 400 V - 3 Ph - 50 Hz*	EM7025100700
Mobiflex 200 M HC - 230 V - 1 Ph - 50 Hz	EM0000119512
Mobiflex 200 M HC - 400 V - 3 Ph - 50 Hz	EM0000119493

### Arm complement

LFA 3.0 arm - 3 m	EM7925160180
LFA 4.0 arm - 4 m	EM7925210180
LFA 3.1 arm - 3 m	EM7925170180
LFA 4.1 arm - 4 m	EM7925220180
Hose, Ø 200 mm L 5 m + magnetic stand collector	EM7900068030
Extension hose, Ø 200 mm L 5 m	EM7900068040



**AIR TREATMENT  
CATALOGUE**

### ORDERING INFORMATION

DESCRIPTION	PART NUMBER
Mobiflex 200 M/W3 - 230 V - 1 Ph - 50 Hz	EM0000119513
Mobiflex 200 M/W3 - 400 V - 3 Ph - 50 Hz	EM0000118478

### Arm complement and options

See Mobifilter 200 M



## WALLFLEX SC - W3 mechanical filter

The Wallflex mechanical wall-mounted self-cleaning filter is designed for applications that produce large quantities of non-explosive dry fumes.

- Equipment available in "compact" and "separate" version.
- Connection of 1 or 2 extraction arms of the 160 range.
- Maximum filter extraction rate for two arms: 2,400 m<sup>3</sup>/h.
- Polyester filter cartridge with PTFE membrane (filter surface area 20 m<sup>2</sup>).
- Wallflex SC complies with ISO EN 15012-1:2013 welding class W3.
- Offline cleaning (with the fan off) for better cartridge regeneration.
- Integrated compressed air pressure regulator.
- Remote control of filter.
- Easy maintenance of dust drum (capacity 18 l).
- Noise with silencer: 70 dB(A).
- Weight: 125 kg.

### WALLFLEX includes the following:

- Filter unit.
- Fan and outlet adapter.
- Check valve.
- Filter control electrical box.
- Dust drum + 5 plastic bags.
- Compressed air pressure regulator.

### ORDERING INFORMATION

DESCRIPTION	PART NUMBER
Wallflex Compact for 1 extraction arm - 1.1 kW - 400 V	
Wallflex 1200 CSC - W3	<b>EM61000376</b>
Wallflex Compact for 2 extraction arms - 2.2 kW - 400 V	
Wallflex 2400 CSC - W3	<b>EM61000377</b>
Wallflex Separate for 1 extraction arm - 1.1 kW - 400 V	
Wallflex 1200 SC - W3	<b>EM61000378</b>
Wallflex Separate for 2 extraction arms - 2.2 kW - 400 V	
Wallflex 2400 SC - W3	<b>EM61000379</b>

### Specifications

- Filter cartridge with highly efficient PTFE membrane on polyester support
- Self-cleaning system with pulse amplifier

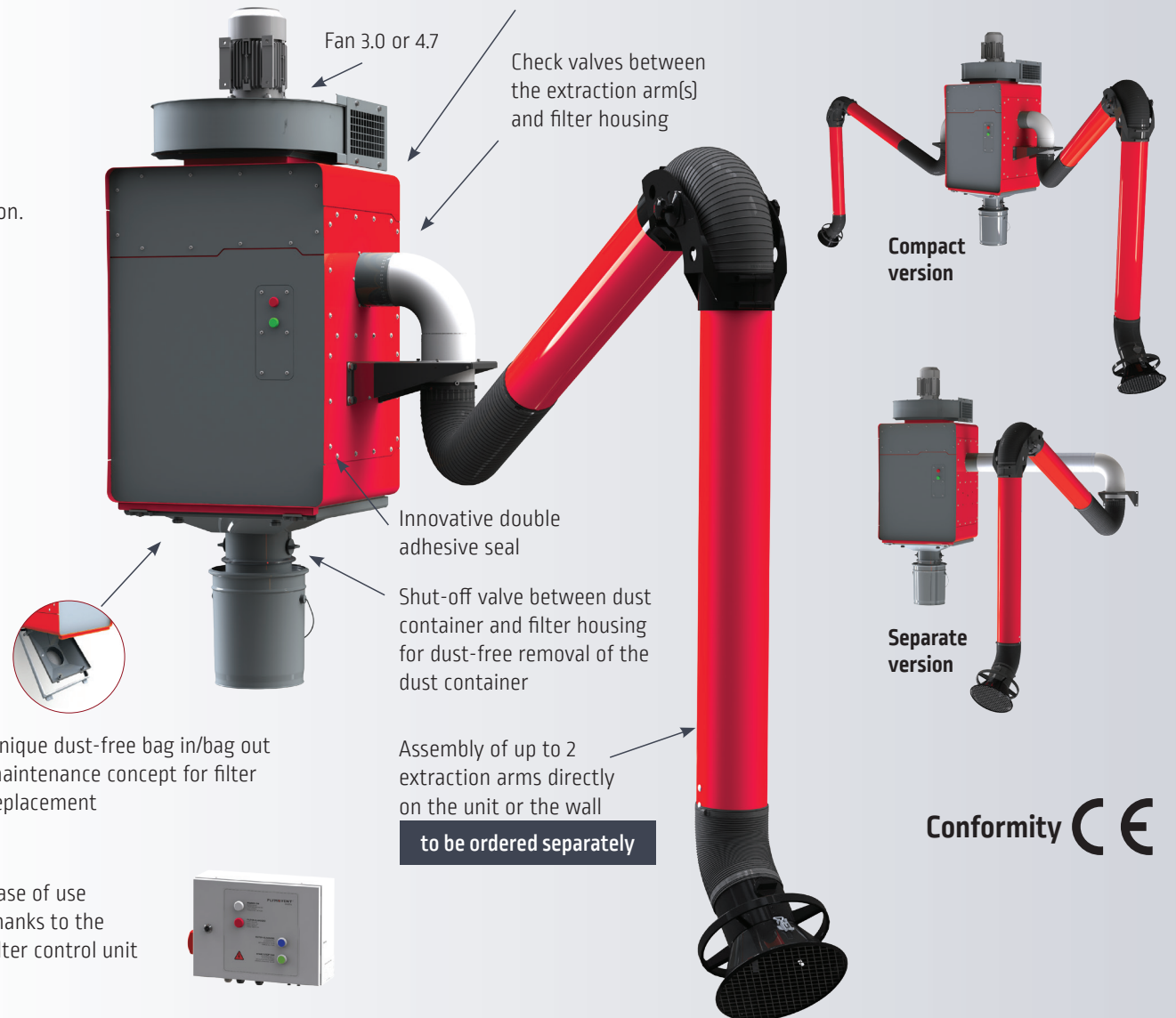

Conformity 

## STATIFLEX 200 M mechanical filter

The Statiflex 200 M filter is designed for filtering non-abundant non-explosive dry particles and fumes. It offers a simple and cost-effective solution.

- Maximum capture rate with two extraction arms: 2,400 m<sup>3</sup>/h .
- Cassette type mechanical filter.
- Metal pre-filter - Class EU2.
- Fine filter of the cartridge type Class M - Filter surface area: 50 m<sup>2</sup>.
- Filter cartridge saturation indicator.
- Noise: 69 dB(A).
- To be used with one 28 fanper arm.
- Complement:
  - 1 or 2 LTA or LFA arms.

Conformity 



### ORDERING INFORMATION

DESCRIPTION	PART NUMBER
Statiflex 200 M	EM7435000700

### Complement for fan per arm

28 fan - 230 V - 1 Ph - 0.75 kW	EM7905220710
28 fan - 400 V - 3 Ph - 0.75 kW	EM7905220740
Circuit breaker or disconnecting box	
Check valve	EM7900030810

### Consumables

Metal pre-filter	EM9820310110
Filter cartridge, 50 m <sup>2</sup>	EM9850060050



### Specifications

Air outlet to the left or right of the machine

Air inlet to the left or right of the machine

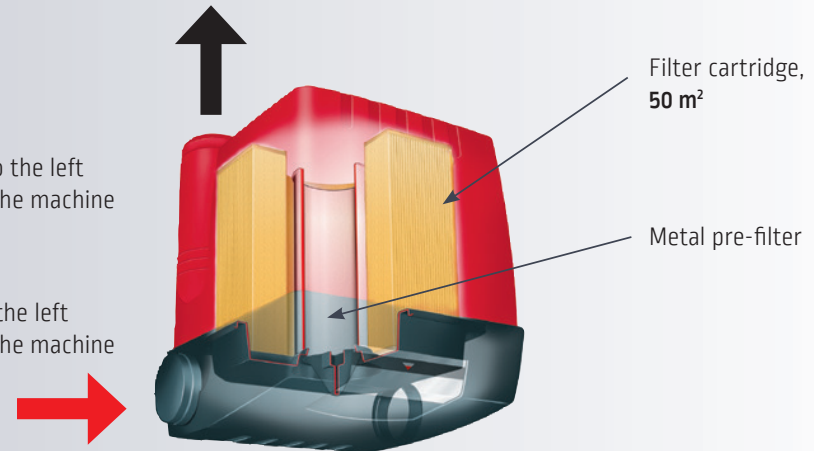

AIR TREATMENT  
CATALOGUE





# HIGH VACUUM



## HIGH VACUUM

The high-vacuum (HV) process is used for extraction at source of welding fume emissions using a number of collectors. The most common are extraction torches, extraction jigs, extraction nozzles or laminar collectors.

The vacuum to be applied by the collector ranges from 11,000 to 15,000 Pa. To that end, Lincoln Electric has developed a range of independent turbines and high-efficiency high-vacuum units.

The minimum components of a system are:

- Collector (out of those named below),
- An individual high-vacuum turbine or central unit,
- A centralised system if the choice of a central high-vacuum unit is made,
- Filtration is strongly recommended.

### Example of high-vacuum equipment:

- A** High-vacuum central unit
- B** Extraction torch
- C** Laminar collector – extraction nozzle
- D** Floor-standing extraction device



**OUR TEAM OF FUME CONTROL SPECIALISTS WILL PREPARE A PROJECT THAT WILL ADDRESS YOUR REQUIREMENTS**

# PROCESS



**AIR TREATMENT CATALOGUE**



## HIGH VACUUM CENTRAL UNITS

Our range of central units covers extraction needs from 1,000 to 4,000 m<sup>3</sup>/h at vacuum values from 20,000 to 25,000 Pascals. These units have horizontal air flow characteristics, which means that the vacuum is constant regardless of the required flow rate. Thus, we can guarantee the total efficiency of the extraction collector. The choice will thus be made based on the required maximum flow rate. The central unit is available in a compact version with filtration or a separate version with optional filtration.

Applications that are mainly dedicated to welding with the help of fume extraction torches, extraction jigs, extraction nozzles, laminar collectors or systems for extracting dust from the floor.

Central units are adapted for all non-explosive dry dust or fumes.

### Specifications:

- Extraction capacity 1,000 to 4,000 m<sup>3</sup>/h, or 5 to 30 welders simultaneously using fume extraction torches.
- Constant nominal working vacuum from 20,000 to 25,000 Pa.
- PLC management with remote control with HMI screen.
- High-efficiency high-pressure backward centrifugal fan.
- Power consumption optimised for the number of torches in operation.
- Frequency variator to allow the gradual starting up of the turbine.
- High-performance self-cleaning cyclone filter. Polyester medium filter cartridges with high-efficiency PTFE membrane, class H13.
- 40- litre drum(s) for dust recovery.
- Podded duct silencer and vertical discharge kit to limit noise to 75 dB(A) at 1 metre.
- Rugged soundproofing box in epoxy painted galvanised metal plates. EU2 class metal pre-filter if the cyclone filter is not selected.

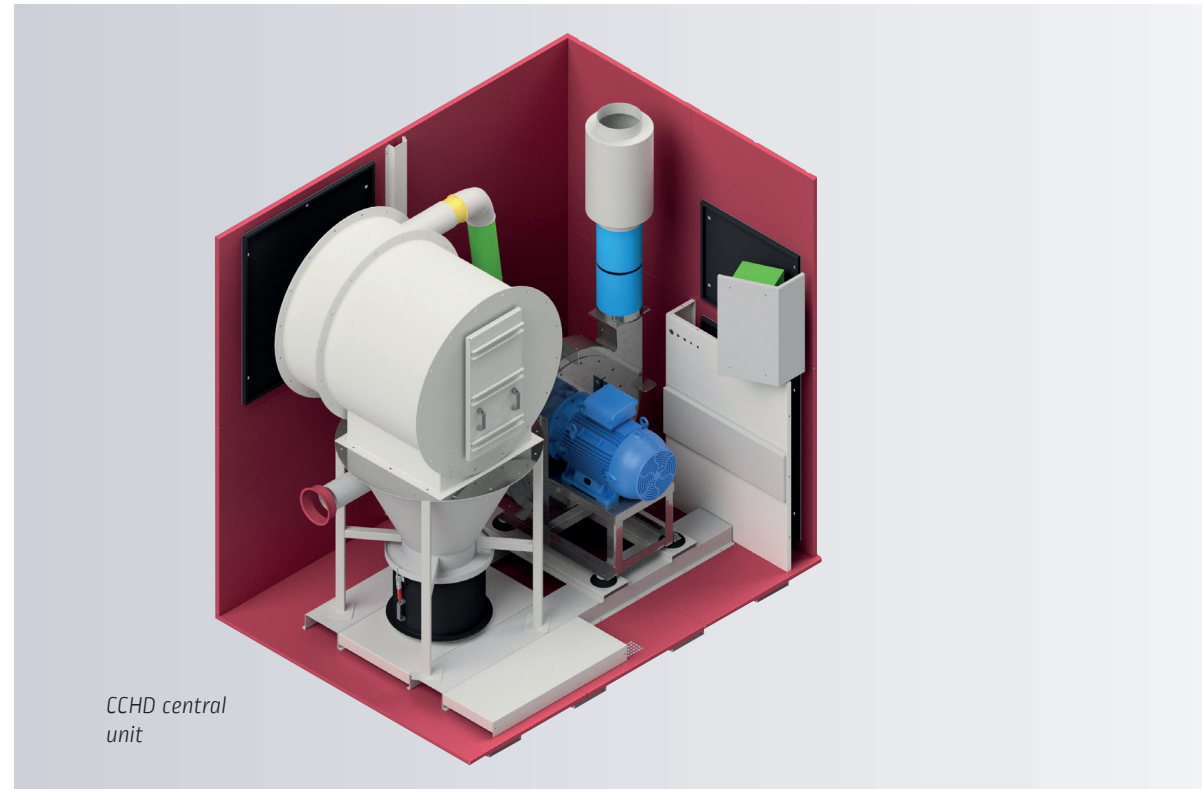

*CCHD central unit*

### Description of 5.7" touch screen HMI functions:

- Operating modes: manual/automatic/clock.
- Dynamic mode display of unit operating status.
- Threshold-based or continuous cleaning of filter cartridges.
- Real-time display of main parameters:
  - filter cartridge pressure difference,
  - fan power consumption,
  - working frequency,
  - compressed air pressure.
- Weekly programming clock.
- Remote control with 15 m cable.
- Stack light showing On, Off, Safety alarm.
- Settings saved on USB stick.
- Filter cartridge pressure difference trend curve.
- Filter maintenance management:
  - hours of use,
  - cartridge replacement,
  - fan maintenance,
  - dust drum maintenance.

## HIGH VACUUM CENTRAL UNITS cd.



Conformity **CE**

### ORDERING INFORMATION

CCHD - COMPACT TYPE	PART NUMBER
<b>CCHD 1000 - 20000</b> Operating point: <b>1,000 m<sup>3</sup>/h at 20,000 Pa</b> 5 fume extraction torches operating simultaneously Fan, 15 kW - 400 V - 3 phases Cyclone filter 2 CD incorporated	EM61000140
<b>CCHD 1000 - 25000</b> Operating point: <b>1,000 m<sup>3</sup>/h at 25,000 Pa</b> 8 fume extraction torches operating simultaneously Fan, 22 kW - 400 V - 3 phases Cyclone filter 2 CD incorporated	EM61000141
<b>CCHD 2000 - 25000</b> Operating point: <b>2,000 m<sup>3</sup>/h at 25,000 Pa</b> 14 fume extraction torches operating simultaneously Fan, 37 kW - 400 V - 3 phases Cyclone filter 2 CD incorporated	EM61000142
<b>CCHD 3000 - 25000</b> Operating point: <b>3,000 m<sup>3</sup>/h at 25,000 Pa</b> 22 fume extraction torches operating simultaneously Fan, 45 kW - 400 V - 3 phases Cyclone filter 4 CD incorporated	EM61000143
<b>CCHD 4000 - 25000</b> Operating point: <b>4,000 m<sup>3</sup>/h at 25,000 Pa</b> 30 fume extraction torches operating simultaneously Fan, 55 kW - 400 V - 3 phases Cyclone filter 4 CD incorporated	EM61000144

DESCRIPTION	PART NUMBER
Roof for CHD 1000 - 2000 - 3000 - 4000	EM61000239
Roof for CCHD 1000 - 2000 - 3000 - 4000	EM61000145
Filter cartridge with PTFE membrane - surface 15 m <sup>2</sup>	EM61000155
Metal pre-filter, 500 x 500 x 24 mm (LxWxH) - Class EU2	W000379647



## LINC GUN FX fume extraction torches

LINC GUN FX fume extraction torches from Lincoln Electric benefit from the experience acquired ever since these products were added to the range. As a result, LINC GUN FX torches are extraction tools offering high engineering quality for MIG-MAG welding.

They use the indirect capture technique which ensures very high efficiency without altering the quality of the weld bead.

We offer a complete range from 225 to 410 A with water or air cooling.

The developments of the LGFX torch combined with our ergonomic booms mean that our products offer very high manoeuvrability and accessibility to the different points of the part to weld.

### Features:

- Large capture sphere, efficiency percentage close to 80%.
- Fixed fume collector.
- Tellurium-copper (Cu Te) screw-in nozzle - Ø 12, 15 or 19 mm.
- Rotating steel fitting at the handle outlet for greater manoeuvrability.
- Manual air flow adjustment valve.
- Single-section (Ø 40 mm) bundle or double section (40/50) depending on the model.
- Protective leather sleeve on the bundle - length 1.5 m.
- Connection diameter on 50 mm hose.
- Dual Flow version for modulating the torch extraction rate depending on the type of part to weld.
- LN version (gooseneck, 50 mm longer) for specific parts to weld and complex access.



AIR



WATER

MINIMUM CAPTURE PERFORMANCE					
For speed 0.25 m/s	Flow m <sup>3</sup> /h	92			
	Vacuum Pa	11,500			
For speed 0.35 m/s	Flow m <sup>3</sup> /h		80	80	80
	Vacuum Pa		13,300	13,500	13,600

		AIR		WATER	
		LGFX 2R	LGFX 4R	LGFX 4W	LGFX 5W
Contact tip		M6	M8 x 30	M8 x 30	M8 x 30
Ø Nozzle		12 mm	15 - 19 mm	15 - 19 mm	15 - 19 mm
Gooseneck angle		45°	45°	45°	45°
Bundle diameter (mm)		40	40	40/50	40/50
Duty factor		60%	60%	100%	100%
Connecting hose diameter (mm)		50	50	50	50
Welding intensity	CO <sub>2</sub>	250 A	400 A	360 A	450 A
	Ar/CO <sub>2</sub>	225 A	320 A	320 A	410 A
Weight (g) according to standard		1,180	1,465	1,540	1,595

## MODULO MD2 unit

The Modulo MD2 turbine is the leader in the area of high-vacuum turbines designed for extracting welding fumes from fume extraction torches.

- Turbine, 3 kW - 230/400 V - 3 Ph - 50 Hz.
- Automatic starting by current sensor or outside contact.
- Diameter of connection to extraction: 50 mm.
- Metal pre-filter - Class EU2.
- Fine polyester filter, Class M  
Filter surface area: 5 m<sup>2</sup> (not supplied as standard).
- Cleaning by manual compressed air pulses.
- Dust recovery drawer.
- 5 m long power cable.
- Ø 80 mm connection to an outdoor discharge or collecting system.
- Mobile assembly with two large wheels.
- Noise: 70 dB(A).
- No-load flow rate: 310 m<sup>3</sup>/h at 30,000 Pa maximum.
- A second torch may be connected in some conditions.
- Weight 97 kg.
- Dimensions: 520 x 515 x 1,060 mm (LxWxH).

Conformity 

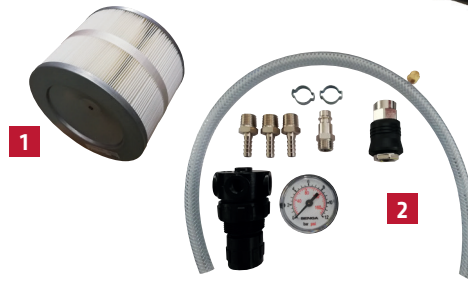

**AIR TREATMENT  
CATALOGUE**

### ORDERING INFORMATION

DESCRIPTION	PART NUMBER
Modulo MD2 turbine, 230/400 V - 3 Ph - 50 Hz	W000401385
Filter cartridge [Reference 1]	W000382775

#### Option

Pressure reducer filter + compressed air connection hose [Reference 2]	W000401386
Additional connection for connecting a hose, Ø 50 mm	W000403083

#### Consumables

Metal pre-filter, 355 x 445 x 24 mm	W000340600
-------------------------------------	------------

### ORDERING INFORMATION

DESCRIPTION	PART NUMBER	
<b>Air cooled torch</b>		
LGFX 4W	3 m	EM61000329
	4 m	EM61000330
	5 m	EM61000331
LGFX 5W	3 m	EM61000332
	4 m	EM61000333
	5 m	EM61000334
LGFX 4W LN	4 m	EM61000335
LGFX 5W LN	4 m	EM61000336

DESCRIPTION	PART NUMBER	
<b>Air cooled torch</b>		
LGFX 2R	3 m	EM61000322
	4 m	EM61000323
	5 m	EM61000324
LGFX 4R	3 m	EM61000325
	4 m	EM61000326
	5 m	EM61000327
LGFX 4R LN	4 m	EM61000328



## CONFIGURATION OF A TYPICAL INSTALLATION

If the dimensions of the workshop are larger than those stated opposite, a combination of several AMBICLEAN units will be needed. Technical study on request.

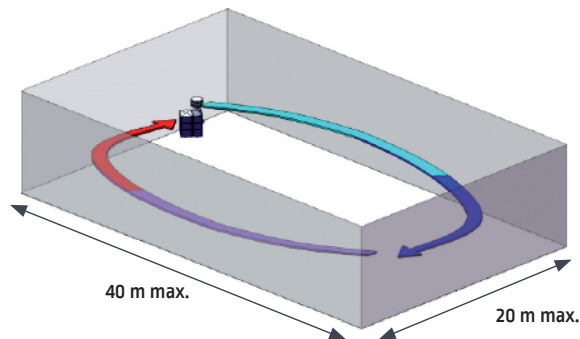

### ORDERING INFORMATION

DESCRIPTION	PART NUMBER
<b>AMBICLEAN 8000</b> Blowing flow rate adjustable from 5,000 to 90,00 m <sup>3</sup> /h - Motor 75 kW - 400 V - 3 Phases 8 x 15 m <sup>2</sup> filter cartridges - W3	EM61000074
<b>AMBICLEAN 12000</b> Blowing flow rate adjustable from 6,000 to 13,000 m <sup>3</sup> /h - Motor 15 kW - 400 V - 3 Phases 12 x 15 m <sup>2</sup> filter cartridges - W3	EM61000075
<b>AMBICLEAN 16000</b> Blowing flow rate adjustable from 8,000 to 18,000 m <sup>3</sup> /h - Motor 18.5 kW - 400 V - 3 Phases 16 x 15 m <sup>2</sup> filter cartridges - W3	EM61000076

## AMBICLEAN W3 is innovative, economical and easy to use

The Ambiclean puts into motion the cloud of fumes stagnating in the workshop. It captures, filters and recycles it into the workshop through blowing nozzles.

The system is simple and does not make it necessary to use a ducting system.

It does not generate heat loss or drafts that could disturb welding.

### Specifications:

- High-performance self cleaning.
- PLC management with remote control with a 5.7" touch screen HMI.
- High-efficiency backward centrifugal fan.
- Class EU2 metal pre-filter.
- Polyester medium filter cartridges with high-efficiency PTFE membrane, class H13.
- Complies with European standard W3 EN 15012-1.
- 40-litre drum(s) for dust recovery.
- Rugged filter structure made in epoxy painted galvanised metal.



**AIR TREATMENT  
CATALOGUE**

#### **CUSTOMER ASSISTANCE POLICY**

The business of The Lincoln Electric Company® is manufacturing and selling high quality welding equipment, consumables, and cutting equipment. Our challenge is to meet the needs of our customers and to exceed their expectations. On occasion, purchasers may ask Lincoln Electric for information or advice about their use of our products. Our employees respond to inquiries to the best of their ability based on information provided to them by the customers and the knowledge they may have concerning the application. Our employees, however, are not in a position to verify the information provided or to evaluate the engineering requirements for the particular weldment. Accordingly, Lincoln Electric does not warrant or guarantee or assume any liability with respect to such information or advice. Moreover, the provision of such information or advice does not create, expand, or alter any warranty on our products. Any express or implied warranty that might arise from the information or advice, including any implied warranty of merchantability or any warranty of fitness for any customers' particular purpose is specifically disclaimed.

Lincoln Electric is a responsive manufacturer, but the selection and use of specific products sold by Lincoln Electric is solely within the control of, and remains the sole responsibility of the customer. Many variables beyond the control of Lincoln Electric affect the results obtained in applying these types of fabrication methods and service requirements.

Subject to Change – This information is accurate to the best of our knowledge at the time of printing. Please refer to [www.lincolnelectric.eu](http://www.lincolnelectric.eu) for any updated information.



[www.lincolnelectriceurope.com](http://www.lincolnelectriceurope.com)

