

POWERTEC® i250C & i320C STANDARD POWERTEC® i250C & i320C ADVANCED POWERTEC® i380C & i450C ADVANCED

OPERATOR'S MANUAL



ENGLISH





THANK YOU! For choosing the **QUALITY** of the Lincoln Electric products.

- Please check packaging and equipment for damage. Claims for material damaged in shipment must be notified immediately to the dealer.
- For ease of use, please enter your product identification data in the table below. Model Name, Code & Serial Number can be found on the machine rating plate.

Model Name:	
.....	
Code & Serial number:	
.....	
Date & Where Purchased:	
.....	

ENGLISH INDEX

Technical Specifications.....	1
ECO design information.....	4
Electromagnetic Compatibility (EMC).....	6
Safety.....	7
Introduction.....	9
Installation and Operator Instructions.....	9
WEEE.....	26
Spare Parts.....	26
Authorized Service Shops Location.....	26
Electrical Schematic.....	26
Accessories.....	27
Dimension Diagram.....	29

Technical Specifications

NAME		INDEX			
POWERTEC® i250C STANDARD		K14284-1			
POWERTEC® i250C ADVANCED		K14285-1			
POWERTEC® i320C STANDARD		K14286-1			
POWERTEC® i320C ADVANCED		K14287-1			
POWERTEC® i380C ADVANCED		K14288-1			
POWERTEC® i450C ADVANCED		K14289-1			
INPUT					
	Input Voltage U ₁	EMC Class	Frequency		
i250C STANDARD	400V ± 15%, 3-phase	A	50/60Hz		
i250C ADVANCED					
i320C STANDARD					
i320C ADVANCED					
i380C ADVANCED					
i450C ADVANCED					
	Input Power at Rated Cycle	Input Amperes I _{1max}	PF		
i250C STANDARD	10,3 kVA @ 60% Duty Cycle (40°C)	14,7 A	0,85		
i250C ADVANCED					
i320C STANDARD	13,6 kVA @ 40% Duty Cycle (40°C)	19,6 A	0,90		
i320C ADVANCED					
i380C ADVANCED	17,1 kVA @ 40% Duty Cycle (40°C)	26 A	0,92		
i450C ADVANCED	20,7 kVA @ 80% Duty Cycle (40°C)	30 A	0,92		
RATED OUTPUT					
i250C STANDARD i250C ADVANCED	Process	Open Circuit Voltage	Duty Cycle 40°C (based on a 10 min. period)	Output Current	Output Voltage
	GMAW	49Vdc	60%	250A	26,5Vdc
			100%	195A	23,8Vdc
			60%	250A	26,5Vdc
			100%	195A	23,8Vdc
	FCAW		60%	250A	30Vdc
			100%	195A	27,8Vdc
			GMAW	40%	320A
60%				250A	26,5Vdc
100%	195A	23,8Vdc			
FCAW	40%	320A		30Vdc	
	60%	250A		26,5Vdc	
	100%	195A		23,8Vdc	
	SMAW	40%		320A	32,8Vdc
60%		250A		30Vdc	
100%		195A	27,8Vdc		
i320C STANDARD i320C ADVANCED		49Vdc	40%	320A	30Vdc
	60%		250A	26,5Vdc	
	100%		195A	23,8Vdc	
	40%		320A	30Vdc	
	60%		250A	26,5Vdc	
	100%		195A	23,8Vdc	
	40%		320A	32,8Vdc	
	60%		250A	30Vdc	
100%	195A	27,8Vdc			

i380C ADVANCED	GMAW	54Vdc (peak) 48Vdc (RMS)	40%	380A	33,0Vdc
			60%	320A	30,0Vdc
			100%	240A	26,0Vdc
	FCAW		40%	380A	33,0Vdc
			60%	320A	30,0Vdc
			100%	240A	26,0Vdc
	SMAW		40%	380A	35,2Vdc
			60%	320A	32,8Vdc
			100%	240A	29,6Vdc
i450C ADVANCED	GMAW	60Vdc (peak) 49Vdc (RMS)	80%	450A	36,5Vdc
			100%	420A	35,0Vdc
	FCAW		80%	450A	36,5Vdc
			100%	420A	35,0Vdc
	SMAW		80%	450A	38,0Vdc
			100%	420A	36,8Vdc
WELDING CURRENT RANGE					
	GMAW		FCAW		SMAW
i250C STANDARD	10A÷250A		10A÷250A		10A÷250A
i250C ADVANCED	10A÷250A		10A÷250A		10A÷250A
i320C STANDARD	10A÷320A		10A÷320A		10A÷320A
i320C ADVANCED	10A÷320A		10A÷320A		10A÷320A
i380C ADVANCED	20A÷380A		20A÷380A		10A÷380A
i450C ADVANCED	20A÷450A		20A÷450A		10A÷450A
RECOMMENDED INPUT CABLE AND FUSE SIZES					
	Fuse Type gR or Circuit Breaker Type Z			Power Lead	
i250C STANDARD	16A, 400V AC			4 Conductor, 2,5mm ²	
i250C ADVANCED	16A, 400V AC			4 Conductor, 2,5mm ²	
i320C STANDARD	20A, 400V AC			4 Conductor, 2,5mm ²	
i320C ADVANCED	20A, 400V AC			4 Conductor, 2,5mm ²	
i380C ADVANCED	25A, 400V AC			4 Conductor, 2,5mm ²	
i450C ADVANCED	32A, 400V AC			4 Conductor, 4,0mm ²	
WELDING VOLTAGE REGULATION RANGE					
	GMAW		FCAW		
i250C STANDARD	10V÷ 28,5V		10V÷ 28,5V		
i250C ADVANCED					
i320C STANDARD	10V÷ 32V		10V÷ 32V		
i320C ADVANCED					
i380C ADVANCED	10V÷ 35V		10V÷ 35V		
i450C ADVANCED	10V÷ 38,5V		10V÷ 38,5V		

WIRE FEED SPEED RANGE / WIRE DIAMETER				
	WFS Range	Drive Rolls	Drive roll diameter	
i250C STANDARD	1,5 ÷ 20,32m/min	4	Ø37	
i250C ADVANCED				
i320C STANDARD				
i320C ADVANCED				
i380C ADVANCED				
i450C ADVANCED				
	Solid Wires	Aluminum Wires	Cored Wires	
i250C STANDARD	0,8 ÷ 1,2 mm	1,0 ÷ 1,2 mm	0,9 ÷ 1,2 mm	
i250C ADVANCED				
i320C STANDARD				
i320C ADVANCED				
i380C ADVANCED	0,8 ÷ 1,4 mm	1,0 ÷ 1,2 mm	0,9 ÷ 1,4 mm	
i450C ADVANCED	0,8 ÷ 1,6 mm	1,0 ÷ 1,6 mm	0,9 ÷ 1,6 mm	
DIMENSION				
	Weight	Height	Width	Length
i250C STANDARD	69 kg	878 mm	560 mm	935 mm
i250C ADVANCED	70 kg			
i320C STANDARD	69 kg			
i320C ADVANCED	70 kg			
i380C ADVANCED	70 kg			
i450C ADVANCED	82 kg			
OTHERS				
	Protection Rating	Maximum Gas Pressure	Operating Humidity (t=20°C)	
i250C STANDARD	IP23	0,5MPa (5 bar)	≤ 90 %	
i250C ADVANCED				
i320C STANDARD				
i320C ADVANCED				
i380C ADVANCED				
i450C ADVANCED				
	Operating Temperature	Storage Temperature		
i250C STANDARD	from -10°C to +40°C	from -25°C to 55°C		
i250C ADVANCED				
i320C STANDARD				
i320C ADVANCED				
i380C ADVANCED				
i450C ADVANCED				

ECO design information

The equipment has been designed in order to be compliant with the Directive 2009/125/EC and the Regulation 2019/1784/EU.

Efficiency and idle power consumption:

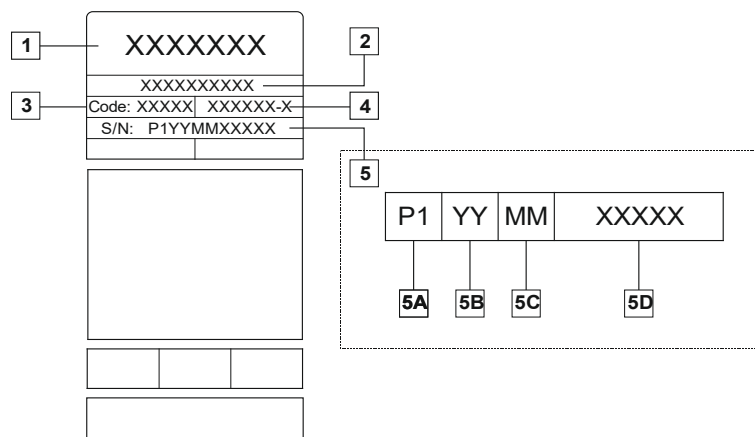
Index	Name	Efficiency when max power consumption / Idle power consumption	Equivalent model
K14284-1	POWERTEC® i250C STANDARD	87,2% / 27W	No equivalent model
K14285-1	POWERTEC® i250C ADVANCED	87,2% / 27W	No equivalent model
K14286-1	POWERTEC® i320C STANDARD	87,2% / 27W	No equivalent model
K14287-1	POWERTEC® i320C ADVANCED	87,2% / 27W	No equivalent model
K14288-1	POWERTEC® i380C ADVANCED	86,2% / 29W	No equivalent model
K14289-1	POWERTEC® i450C ADVANCED	88,3% / 29W	No equivalent model

Idle state occurs under the condition specified in below table

IDLE STATE	
Condition	Presence
MIG mode	X
TIG mode	
STICK mode	
After 30 minutes of non-working	
Fan off	X

The value of efficiency and consumption in idle state have been measured by method and conditions defined in the product standard EN 60974-1:20XX.

Manufacturer's name, product name, code number, product number, serial number and date of production can be read from rating plate.



Where:

- 1- Manufacturer name and address
- 2- Product name
- 3- Code number
- 4- Product number
- 5- Serial number
 - 5A- country of production
 - 5B- year of production
 - 5C- month of production
 - 5D- progressive number different for each machine

Typical gas usage for **MIG/MAG** equipment:

Material type	Wire diameter [mm]	DC electrode positive		Wire Feeding [m/min]	Shielding Gas	Gas flow [l/min]
		Current [A]	Voltage [V]			
Carbon, low alloy steel	0,9 ÷ 1,1	95 ÷ 200	18 ÷ 22	3,5 – 6,5	Ar 75%, CO ₂ 25%	12
Aluminium	0,8 ÷ 1,6	90 ÷ 240	18 ÷ 26	5,5 – 9,5	Argon	14 ÷ 19
Austenitic stainless steel	0,8 ÷ 1,6	85 ÷ 300	21 ÷ 28	3 - 7	Ar 98%, O ₂ 2% / He 90%, Ar 7,5% CO ₂ 2,5%	14 ÷ 16
Copper alloy	0,9 ÷ 1,6	175 ÷ 385	23 ÷ 26	6 - 11	Argon	12 ÷ 16
Magnesium	1,6 ÷ 2,4	70 ÷ 335	16 ÷ 26	4 - 15	Argon	24 ÷ 28

Tig Process:

In TIG welding process, gas usage depends on cross-sectional area of the nozzle. For commonly used torches:

Helium: 14-24 l/min

Argon: 7-16 l/min

Notice: Excessive flow rates causes turbulence in the gas stream which may aspirate atmospheric contamination into the welding pool.

Notice: A cross wind or draft moving can disrupt the shielding gas coverage, in the interest of saving of protective gas use screen to block air flow.



End of life

At end of life of product, it has to be disposal for recycling in accordance with Directive 2012/19/EU (WEEE), information about the dismantling of product and Critical Raw Material (CRM) present in the product, can be found at <https://www.lincolnelectric.com/en-gb/support/Pages/operator-manuals-eu.aspx>

Electromagnetic Compatibility (EMC)

01/11

This machine has been designed in accordance with all relevant directives and standards. However, it may still generate electromagnetic disturbances that can affect other systems like telecommunications (telephone, radio, and television) or other safety systems. These disturbances can cause safety problems in the affected systems. Read and understand this section to eliminate or reduce the amount of electromagnetic disturbance generated by this machine.



This machine has been designed to operate in an industrial area. To operate in a domestic area it is necessary to observe particular precautions to eliminate possible electromagnetic disturbances. The operator must install and operate this equipment as described in this manual. If any electromagnetic disturbances are detected the operator must put in place corrective actions to eliminate these disturbances, if necessary with assistance from

Lincoln Electric.

WARNING

Provided that the public low voltage system impedance at the point of common coupling is lower than:

- 56,4 mΩ for the **POWERTEC® I250C STANDARD**
- 56,4 mΩ for the **POWERTEC® I250C ADVANCED**
- 56,4 mΩ for the **POWERTEC® I320C STANDARD**
- 56,4 mΩ for the **POWERTEC® I320C ADVANCED**
- 56,4 mΩ for the **POWERTEC® I380C ADVANCED**
- 23 mΩ for the **POWERTEC® I450C ADVANCED**

This equipment is compliant with IEC 61000-3-11 and IEC 61000-3-12 and can be connected to public low voltage systems. It is the responsibility of the installer or user of the equipment to ensure, by consultation with the distribution network operator if necessary, that the system impedance complies with the impedance restrictions.

Before installing the machine, the operator must check the work area for any devices that may malfunction because of electromagnetic disturbances. Consider the following.

- Input and output cables, control cables, and telephone cables that are in or adjacent to the work area and the machine.
- Radio and/or television transmitters and receivers. Computers or computer controlled equipment.
- Safety and control equipment for industrial processes. Equipment for calibration and measurement.
- Personal medical devices like pacemakers and hearing aids.
- Check the electromagnetic immunity for equipment operating in or near the work area. The operator must be sure that all equipment in the area is compatible. This may require additional protection measures.
- The dimensions of the work area to consider will depend on the construction of the area and other activities that are taking place.

Consider the following guidelines to reduce electromagnetic emissions from the machine.

- Connect the machine to the input supply according to this manual. If disturbances occur it may be necessary to take additional precautions such as filtering the input supply.
- The output cables should be as short as possible and positioned together as close as possible to each other. If possible connect the work piece to ground in order to reduce the electromagnetic emissions. The operator must check that connecting the work piece to ground does not cause problems or unsafe operating conditions for personnel and equipment.
- Shielding of cables in the work area can reduce electromagnetic emissions. This may be necessary for special applications.

WARNING

EMC classification of this product is class A in accordance with electromagnetic compatibility standard EN 60974-10 which means that the product is designed to be used in an industrial environment only.







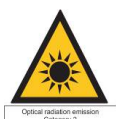

WARNING







The Class A equipment is not intended for use in residential locations where the electrical power is provided by the public low-voltage supply system. There may be potential difficulties in ensuring electromagnetic compatibility in those locations, due to conducted as well as radiated disturbances.



WARNING

This equipment have to be used by qualified personnel. Be sure that all installation, operation, maintenance and repair procedures are performed only by qualified person. Read and understand this manual before operating this equipment. Failure to follow the instructions in this manual could cause serious personal injury, loss of life, or equipment damage. Read and understand the following explanations of the warning symbols. Lincoln Electric is not responsible for damages caused by improper installation, improper care or abnormal operation.

	<p>WARNING: This symbol indicates that instructions must be followed to avoid serious personal injury, loss of life, or equipment damage. Protect yourself and others from possible serious injury or death.</p>
	<p>READ AND UNDERSTAND INSTRUCTIONS: Read and understand this manual before operating this equipment. Arc welding can be hazardous. Failure to follow the instructions in this manual could cause serious personal injury, loss of life, or equipment damage.</p>
	<p>ELECTRIC SHOCK CAN KILL: Welding equipment generates high voltages. Do not touch the electrode, work clamp, or connected work pieces when this equipment is turned on. Insulate yourself from the electrode, work clamp, and connected work pieces.</p>
	<p>ELECTRICALLY POWERED EQUIPMENT: Turn off the input power using the disconnect switch at the fuse box before working on this equipment. Ground this equipment in accordance with local electrical regulations.</p>
	<p>ELECTRICALLY POWERED EQUIPMENT: Regularly inspect the input, electrode, and work clamp cables. If any insulation damage exists replace the cable immediately. Do not place the electrode holder directly on the welding table or any other surface in contact with the work clamp to avoid the risk of accidental arc ignition.</p>
	<p>ELECTROMAGNETIC FIELD MAY BE DANGEROUS: Electric current flowing through any conductor creates electromagnetic field (EMF). EMF fields may interfere with some pacemakers, and welders having a pacemaker shall consult their physician before operating this equipment.</p>
	<p>CE COMPLIANCE: This equipment complies with the European Community Directives.</p>
 <p style="font-size: small;">Optical radiation emission Category 2 (EN 12185)</p>	<p>ARTIFICIAL OPTICAL RADIATION: According with the requirements in 2006/25/EC Directive and EN 12198 Standard, the equipment is a category 2. It makes mandatory the adoption of Personal Protective Equipment (PPE) having filter with a protection degree up to a maximum of 15, as required by EN169 Standard.</p>
	<p>FUMES AND GASES CAN BE DANGEROUS: Welding may produce fumes and gases hazardous to health. Avoid breathing these fumes and gases. To avoid these dangers the operator must use enough ventilation or exhaust to keep fumes and gases away from the breathing zone.</p>
	<p>ARC RAYS CAN BURN: Use a shield with the proper filter and cover plates to protect your eyes from sparks and the rays of the arc when welding or observing. To protect the skin, use suitable clothing made of durable, fireproof material. Protect other nearby personnel with suitable, non-flammable screening and warn them not to watch the arc nor expose themselves to the arc.</p>

	<p>WELDING SPARKS CAN CAUSE FIRE OR EXPLOSION: Remove fire hazards from the welding area and have a fire extinguisher easily accessible. Welding sparks and hot materials from the welding process can easily go through small cracks and openings to adjacent areas. Do not weld on any tanks, drums, containers, or material until the proper steps have been taken to insure that no flammable or toxic vapors will be present. Never use this equipment when flammable gases, vapors or flammable liquids are present.</p>
	<p>WELDED MATERIALS CAN BURN: Welding generates a large amount of heat. Hot surfaces and materials in work area can cause serious burns. Use gloves and pliers when touching or moving materials in the work area.</p>
	<p>CYLINDER MAY EXPLODE IF DAMAGED: Use only certificate, compressed gas cylinders containing the correct shielding gas for the process used and properly operating regulators designed for the gas and pressure used. Always keep cylinders in an upright position securely chained to a fixed support. Do not move or transport gas cylinders with the protection cap removed. Do not allow the electrode, electrode holder, work clamp or any other electrically live part to touch a gas cylinder. Gas cylinders must be located away from areas where they may be subjected to physical damage or the welding process including sparks and heat sources.</p>
	<p>MOVING PARTS ARE DANGEROUS: There are moving mechanical parts in this machine, which can cause serious injury. Keep your hands, body and clothing away from those parts during machine starting, operating and servicing.</p>
	<p>HOT COOLANT CAN BURN SKIN: Always be sure coolant is NOT HOT before servicing the cooler.</p>
	<p>SAFETY MARK: This equipment is suitable for supplying power for welding operations carried out in an environment with increased risk of electric shock.</p>

The manufacturer reserves the right to make changes and/or improvements in design without upgrade at the same time the operator's manual.

Introduction

The welding machines **POWERTEC® i250C STANDARD**, **POWERTEC® i250C ADVANCED**, **POWERTEC® i320C STANDARD**, **POWERTEC® i320C ADVANCED**, **POWERTEC® i380C ADVANCED**, **POWERTEC® i450C ADVANCED** enables welding:

- GMAW (MIG/MAG),
- FCAW (Flux-Cored),
- SMAW (MMA),

The complete package contains:

- Work lead – 3m,
- Gas hose – 2m,
- Driving roll V1.0/V1.2 for solid wire (mounted in the wire feeder).

Recommended equipment, which can be bought by user, was mentioned in the chapter "Accessories".

Installation and Operator Instructions

Read this entire section before installation or operation of the machine.

Location and Environment

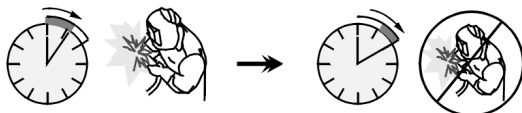
This machine will operate in harsh environments. However, it is important that simple preventative measures are followed to assure long life and reliable operation.

- Do not place or operate this machine on a surface with an incline greater than 15° from horizontal.
- Do not use this machine for pipe thawing.
- This machine must be located where there is free circulation of clean air without restrictions for air movement to and from the air vents. Do not cover the machine with paper, cloth or rags when switched on.
- Dirt and dust that can be drawn into the machine should be kept to a minimum.
- This machine has a protection rating of IP23. Keep it dry when possible and do not place it on wet ground or in puddles.
- Locate the machine away from radio controlled machinery. Normal operation may adversely affect the operation of nearby radio controlled machinery, which may result in injury or equipment damage. Read the section on electromagnetic compatibility in this manual.
- Do not operate in areas with an ambient temperature greater than 40°C.

Duty cycle and Overheating

The duty cycle of a welding machine is the percentage of time in a 10 minute cycle at which the welder can operate the machine at rated welding current.

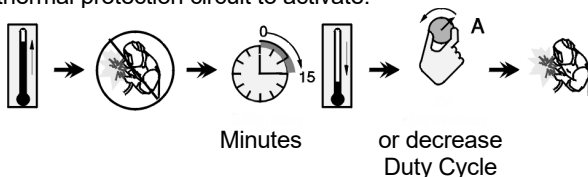
Example: 60% duty cycle



Welding for 6 minutes.

Break for 4 minutes.

Excessive extension of the duty cycle will cause the thermal protection circuit to activate.



Minutes

or decrease
Duty Cycle

Input Supply Connection

⚠ WARNING

Only a qualified electrician can connect the welding machine to the supply network. Installation had to be made in accordance with the appropriate National Electrical Code and local regulations.

Check the input voltage, phase and frequency supplied to this machine before turning it on. Verify the connection of ground wires from the machine to the input source. The welding machine **POWERTEC® i250C STANDARD / ADVANCED**, **POWERTEC® i320C STANDARD / ADVANCED**, **POWERTEC® i380C ADVANCED**, **POWERTEC® i450C ADVANCED** must be connected to a correctly installed plug-in socket with an earth pin. Input voltage is 400 Vac 50/60 Hz. For more information about input supply refer to the technical specification section of this manual and to the rating plate of the machine.

Make sure that the amount of mains power available from the input supply is adequate for normal operation of the machine. The necessary delayed fuse or circuit breaker and cable sizes are indicated in the technical specification section of this manual.

⚠ WARNING

The welding machine can be supplied from a power generator of output power at least 30% larger than input power of the welding machine.

⚠ WARNING

When powering the machine from a generator be sure to turn off welder first, before generator is shut down, in order to prevent damage to welder!

Output Connections

Refer to points [2], [3] and [4] of the Figures below.

Controls and Operational Features

Front panel POWERTEC® i250C&i320C Standard Version

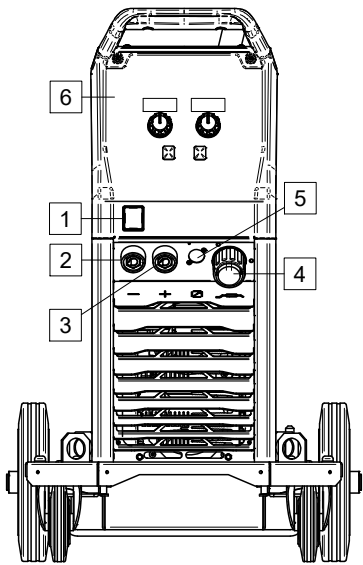


Figure 1

Front panel POWERTEC® i250C&i320C Advanced Version

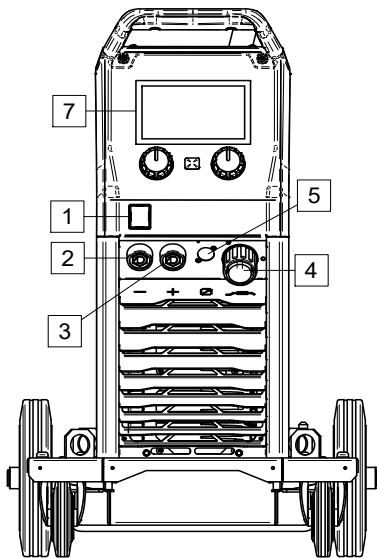


Figure 2

Front panel POWERTEC® i380C&i450C Advanced Version

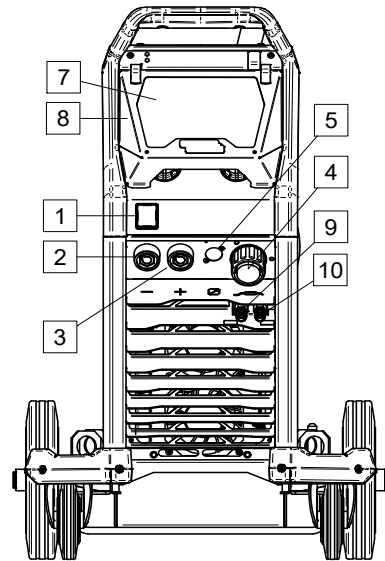






Figure 3

1. Power Switch ON/OFF (I/O): Controls the input power to the machine. Be sure the power source is connected to the mains supply before turning power on ("I"). After input power is connected and the power switch is turned on, the indicator will light up.
2. Negative Output Socket for the Welding Circuit: For connecting an electrode holder with lead / work lead depending on the require configuration. 
3. Positive Output Socket for the Welding Circuit: For connecting an electrode holder with lead / work lead depending on the require configuration. 
4. EURO Socket: For connecting a welding gun (for GMAW / FCAW process).
5. Remote Control Connector Plug: To install Remote Control Kit. This connector allows connection Remote Control. See "Accessories" chapter.
6. U22 User Interface: See "User Interfaces" Chapter.
7. U7 User Interface: See User Interfaces chapter
8. Display Cover. Display protection for U7.
9. Quick Connect Coupling: Coolant outlet (supplies cool coolant to the torch/gun). 
10. Quick Connect Coupling: Coolant inlet (takes warm coolant from torch/gun). 

Rear Panel POWERTEC® i250C&i320C

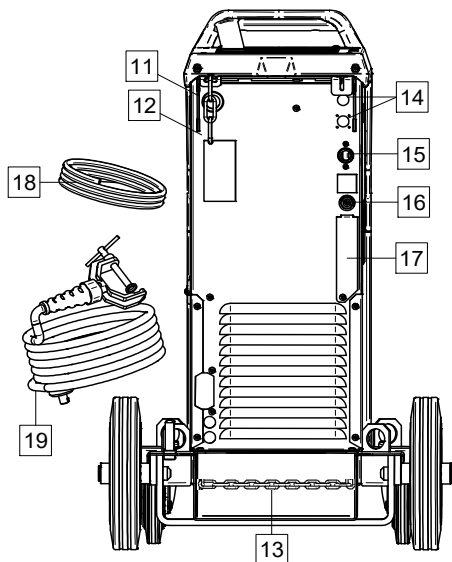


Figure 4

Rear Panel POWERTEC® i380C&i450C

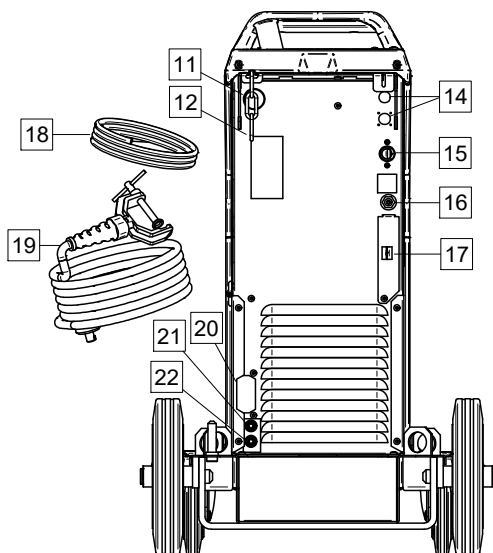



Figure 5


11. Wire Liner Entry: Enables installing liner for welding wire delivered in drum package.
12. Top Chain: To protect gas bottle.
13. Bottom chain: For properly securing the gas cylinder
14. Supply Plug: For gas heater kit (see "Accessories" chapter).
15. Power Lead (5 m): Connect the supply plug to the existing input cable that is rated for the machine as indicated in this manual, and conforms to all applicable standards. This connection shall be performed by a qualified person only.
16. Gas Connector: Connection for gas line.
17. Gas Flow Regulator Plug: Gas flow regulator can be purchased separately (see "Accessories" chapter).

18. Gas hose

19. Work Lead

20. Cover bracket: To install **COOL ARC® 26** power supply and control cable (see "Accessories Suggested" chapter).

21. Quick Connect Coupling: Coolant inlet (supplies cool coolant to the torch/gun). 

22. Quick Connect Coupling: Coolant outlet (takes warm coolant from torch/gun). 

Internal Controls

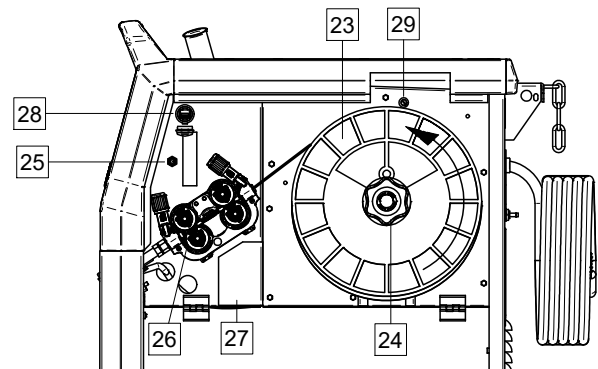


Figure 6

23. Spooled Wire (for GMAW / FCAW): Not supplied as standard.

24. Wire Spool Holder: Maximum 16kg spools. Holder allows mounting plastic, steel and fiber spools onto 51 mm spindle.

Note: Plastic Brake Nut has a Left-hand thread.

25. Switch: Cold Inch / Gas Purge: This switch allows wire feeding (wire test) and gas flow (gas test) without switching on the output voltage.

26. Wire drive: 4-rolls wire drive.

27. Terminal Block of Changing Polarity Plug (for GMAW / FCAW-SS process): This terminal block enables to set the welding polarity (+ ; -), which will be given at the welding gun.

28. USB Receptacle Type A: For USB memory stick connection. For machine software update and service purpose, video playing.

29. Fuse F1: Use the low blow fuse:

POWERTEC®			
i250C	i320C	i380C	i450C
1A / 400V (6,3x32mm)	1A / 400V (6,3x32mm)	2A / 400V (6,3x32mm)	2A / 400V (6,3x32mm)

User Interface U22

The **POWERTEC® i250C & i320C STANDARD** uses the U22 interface based on two separate LED displays for operation.

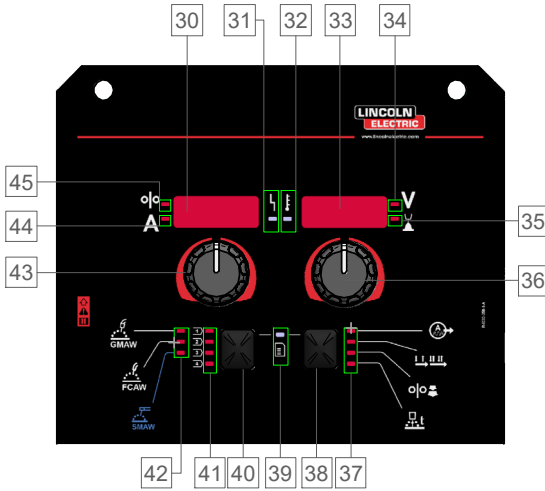


Figure 7

30. **Left Display:** Shows wire feed speed or welding current. During welding shows the actual welding current value.

31. **Status LED:** A two color light that indicates system errors. Normal operation is steady green light. Error conditions are indicated, per Table 1.

Note: The status light will flash green for up to one minute when the machine is turned on for the first time. When the power source is powered it can take as long as up to 60 seconds for the machine to be ready to weld. This is a normal situation as the machine goes through the initialization.




Table 1

LED Light Condition	Meaning
	Only for machines using protocol for communication
Steady Green	Power source is operational, and is communicating normally with all healthy peripheral equipment.
Blinking Green	Occurs during power up or a system reset, and indicates the power source is mapping (identifying) each component connect to the system. This behavior occurs for first after power is turned on, or if the system configuration is changed during operation.
Alternating Green and Red	<p>If the status lights are flashing any combination of red and green color, it means that errors are present in the power source.</p> <p>Each digit of the code corresponds to the number of red flashes of the indicator lamp. Individual code digits are flashed in red with a long pause between digits. If more than one code is present, the codes will be separated by green light. Read the error code before the machine is turned off.</p> <p>To clear the errors try to turn off the machine and wait for a few seconds, then turn on again. If the error remains, a it maintenance is required. Please contact the nearest authorized technical service center or Lincoln Electric and report the error code.</p>
Steady Red	Indicate no communication between the power source and device which has been connected to this power source.

32. Thermal Overload Indicator: It indicates that the machine is overloaded or that the cooling is not sufficient.
33. Right Display: Depending on the source welding and the welding program shows the welding voltage in volts or Trim value. During welding shows the actual welding voltage value.
34. LED Indicator: Informs that the value on the right display is in volts unit and during welding, it blinks and the display shows the measured voltage.
35. LED Indicator: Informs that the value on the right display is Trim. Trim is adjustable from 0.50 to 1.50. 1.00 is the nominal setting.
36. Right Control: Adjusts values on the right display.
37. LED Indicator: Quick Access Menu.
38. Right Button: Enables selecting, changing and setting welding parameters. Quick Access Menu.
39. LED Indicator: Indicates that the Settings and Configuration Menu is activated.
40. Left Button: Enables:
 - Checking the active program number. To check the program number, press the left button once.
 - Changing the Welding Process.
41. Welding Programs Indicators (customizable): Four user programs can be stored in the user memory. Shine LED indicates that the program is active.
42. Welding Programs Indicators (uncustomizable): LED indicates the program for non-synergic process is active. See the table 2.
43. Left Control: Adjusts values on the left display.
44. LED Indicator: Informs that the value on the left display is in ampere units, blinks during welding and the display shows current measured.
45. LED Indicator: Informs that the wire feed speed is on the left display.

Changing the Welding Process or Program

Table 2 . Unchangeable Welding Programs

Symbol	Process	Program Number
	GMAW (non-synergic)	2
	FCAW-GS	7
	SMAW	1

It is possible to quick recall one of the seven welding programs. Three programs are fixed and cannot be changed - Table 2. Four programs can be changed and assigned to one of four user memory. By default, user memories store the first available welding program.

To change the welding process:

- Press the left button [40]. "Pr" is shown on the left display [30] and the actual program number on the right display [33].
- Again, press the left button [40] the welding programs indicator (41 or 42) will pass to the next program in the sequence shown in Figure 8.

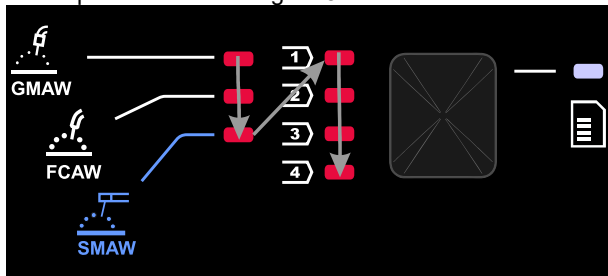






Figure 8

- Press the left button [40] until the LED Indicator (41 or 42) will indicate desired welding program.

WARNING

After the device has been restarted remembers the last selected welding program with its parameters.

U22 User Memory

- 1  In user memory only four welding programs can be stored.
- 2 
- 3 
- 4 

To assign the weld program to user memory:

- Use the left button [40] to select the user memory number (1, 2, 3 or 4) - LED Indicator [41] will light up selected memory.
- Press and hold the left button [40] it until LED Indicator [41] will blink.
- Use the right control [36] to select the welding program.
- To save the selected program, press and hold the left button [40] until LED Indicator will stop blinking.

Quick Access Menu

The user has access to the arc parameters as well as start and end process parameters according to Table 3 and 4.

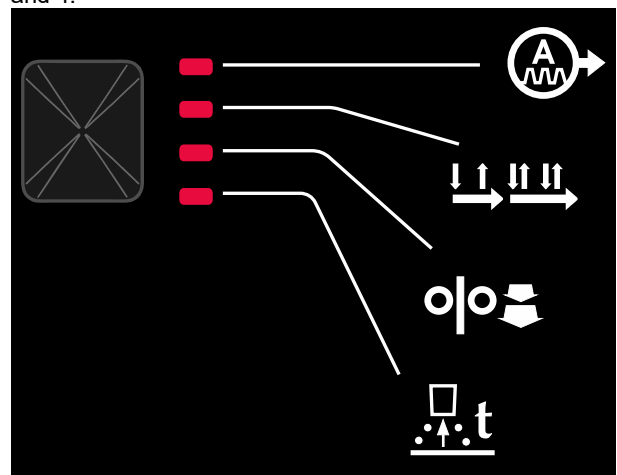


Figure 9

To enter the menu:

- Press the Right Button [38] until the LED Indicator [37] illuminates the required parameter.
- Set the parameter value by the Right Control [36]. The set value is automatically saved.
- The parameter value is shown on the right display [33].
- Press the right button [38] to go to the next parameter.
- Press the left button [40] to exit.

WARNING

Access to the menu is not available under welding, or if there is a fault (status LED [31] is not solid green).

Availability of the parameters in the Quick Access Menu depend on the selected welding program / welding process.

Table 3 Wave Controls





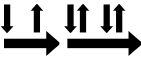



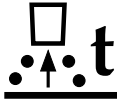

	Parameter	Definition
		<p>Pinch – controls the arc characteristics during short-arc welding. Increasing Pinch value results in a crisper arc (more spatter) while decreasing provides a softer arc (less spatter). Regulation range: from -10.0 to +10.0. Default value: 0.</p>
		<p>ARC FORCE - the output current is temporarily increased prevents the electrode from sticking and facilitates the welding process. Lower values will provided less short circuit current and a softer arc. Higher settings will provided a higher short circuit current, more forceful arc and possibly of more spatter. Default value: 0. Regulation range: from -10.0 to +10.0</p>
		<p>HOT START - regulation of increasing nominal current value during arc start with electrode. It cause temporarily increased of output current and made easy arc start with electrode. Default value: +5. Regulation range: from 0 to +10.0. This parameter is only for SMAW.</p>

Table 4 Process start and end parameters

	Parameter	Definition
		<p>Torch trigger mode (2-step / 4-step) - change the function of the torch trigger.</p> <ul style="list-style-type: none"> • 2 Step trigger operation turns welding on and off as direct response to the trigger. Welding process starts when the torch trigger is press. • 4-Step mode allows to continue welding, when the torch trigger is released. To stop welding, the torch trigger should be pressed again.4-step model facilitates to make long welds. • Default settings: 2-step
		<p>Run-in WFS – sets the wire feed speed from the time the torch trigger is pressed until an arc is established.</p> <ul style="list-style-type: none"> • Regulation range: from 1,49 m/min (59 in/min) to 3,81 m/min (150 in/min). • Default settings for non-synergic mode: OFF. • Default settings for synergic mode: AUTO mode.
		<p>Burnback Time – amount of time that the welding is continued after the wire stops feeding. It prevents the wire from sticking in the puddle and prepares the end of the wire for the next arc ignition.</p> <ul style="list-style-type: none"> • Regulation range: from OFF to 0,25 seconds. • Default settings for non-synergic mode: 0,07s. • Default settings for synergic mode: AUTO mode.

Setting and Configuration Menu

To access the menu, press the left [40] and the right [38] buttons simultaneously.

Parameter Selection Mode – the Parameter Name on the left display [30] blinking.

Parameter Change Value Mode – the parameter value on the right display [33] blinking.

WARNING

To exit the menu with changes saved, press the left [40] and the right [38] buttons simultaneously. After one minute of inactivity the Menu without saving will also exit.

Table 5 Interface Components and functions when the Settings and Configuration Menu is active.

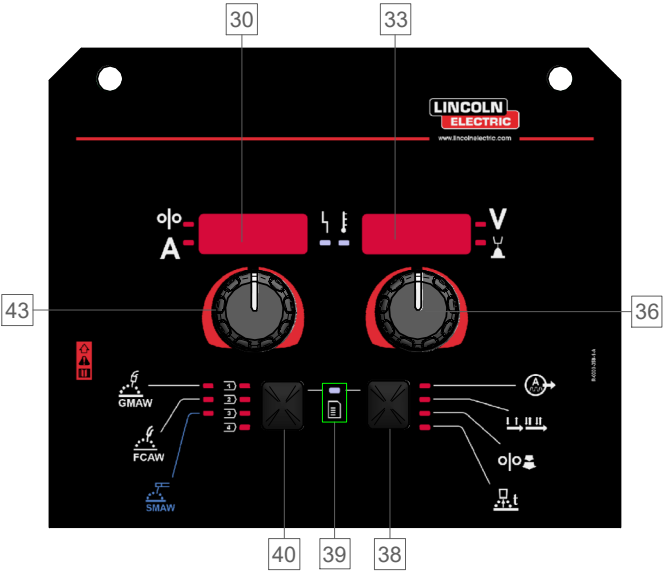
	Functions of Interface Components
	30. Parameter Name. 33. Parameter Value. 36. Changing Parameter Value. 38. Entering to parameter edition. Confirm Parameter Value change. 39. Setting and Device Configuration Menu is active. 40. Cancellation / Exit. 43. Parameter Selection.

Figure 10

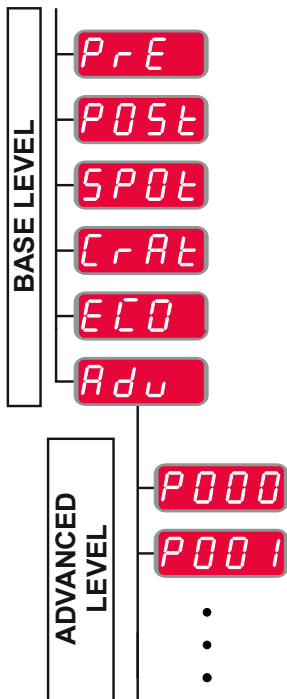


Figure 11

User has access to two menu levels:

- Basic Level – basic menu which is connected with settings of Welding Parameters.
- Advanced Level – advanced menu, configure device menu.

Note: The availability parameters in the Setting and Configuration Menu depend on the selected welding program / welding process.

Note: After the device has been restarted remembers the last selected welding program with its parameters.

Basic Menu (settings related to the welding parameters)

The Basic Menu includes the parameters described in Table 6.

Table 6 The default settings of Basic Menu

Parametr	Definicja
<p>The image shows a digital display with two sections. The left section displays 'PRE' in red LEDs, with 'V' and 'A' indicators above and below it. The right section displays '0.2' in red LEDs, with 'V' and 'A' indicators above and below it. There are also some small icons between the two sections.</p>	<p>Preflow Time – time that shielding gas flows after the torch trigger was pressed before prior to wire feeding.</p> <ul style="list-style-type: none"> • Regulation range: from 0 seconds (OFF) to 25 seconds. • Default settings for non-synergic mode: 0,2s. • Default settings for synergic mode: AUTO mode.
<p>The image shows a digital display with two sections. The left section displays 'POST' in red LEDs, with 'V' and 'A' indicators above and below it. The right section displays '0.5' in red LEDs, with 'V' and 'A' indicators above and below it. There are also some small icons between the two sections.</p>	<p>Postflow Time – time that shielding gas flows after stop welding.</p> <ul style="list-style-type: none"> • Regulation range: from 0 seconds (OFF) to 25 seconds. • Default settings for non-synergic mode: 0,5s. • Default settings for synergic mode: AUTO mode.
<p>The image shows a digital display with two sections. The left section displays 'SPOT' in red LEDs, with 'V' and 'A' indicators above and below it. The right section displays 'OFF' in red LEDs, with 'V' and 'A' indicators above and below it. There are also some small icons between the two sections.</p>	<p>Spot Timer – sets the total welding time even if the torch trigger is still pressed. This function does not work in 4-Step Trigger Mode.</p> <ul style="list-style-type: none"> • Regulation range: from 0 second (OFF) to 120 seconds. • Default settings: OFF. <p>Note: Spot Timer has no effect in 4-Step Trigger Mode.</p>
<p>The image shows a digital display with two sections. The left section displays 'CRAT' in red LEDs, with 'V' and 'A' indicators above and below it. The right section displays 'OFF' in red LEDs, with 'V' and 'A' indicators above and below it. There are also some small icons between the two sections.</p>	<p>Crater Procedure controls the WFS (or value in ampere) and Volts (or Trim) for a specified time at the end of the welding after the trigger was released. During the crater time, the machine will ramp up or down from the Weld Procedure to the Crater Procedure.</p> <ul style="list-style-type: none"> • Adjust time range: from 0 seconds (OFF) to 10 seconds. • Default settings: OFF. <p>Crater parameters:</p> <ul style="list-style-type: none"> • Crater time • Wire feed speed or welding current. • Voltage Trim value. <p>To set a crater for a selected process:</p> <ul style="list-style-type: none"> • Press the right button [38]. • "SEC" appears on the left display [30]. • On the right display [33] the value in seconds flashes. • Set the crater time with the right control [36]. • Confirm the setting of the crater time with the right button [38]. • The left display [30] shows the value of the wire feed speed or welding current, the right display [33] shows the voltage or the Trim value. • Set the value on the left display [30] by the left control [43]. • Set the value on the right display [33] with the right control [36]. • Confirm the settings - press the right button [38].



Green Mode – is a power management feature that enables welding equipment to switch to low power state and reduce power consumption while is not using.

Display Configuration Settings:

- Standby
- Shutdown

Standby – this option allows you to reduce energy consumption to the level below 50W when the welding equipment is unused.

- Default value: OFF.

To set the time for Standby option:

- Press right control [36] to enter in to Standby menu
- By the right control [36] set require time from 10-300min range or Off this function.
- Press right control [36] to confirm.
- When machine is under Standby mode any action on user interface or trigger activates normal work of welding machine.

Shutdown – this option allows you to reduce energy consumption to the level below 10W when the welding equipment is unused.

- Default value: OFF.

To set the time when Shutdown option will be turn on:

- Press right control [36] to enter in to Shutdown menu
- By the right control [36] set require time from 10-300min range or Off this function.
- Press right control [36] to confirm.
- Operating system inform you 15s before activate Shutdown Mode by time counter.

Note: When machine is under Shutdown mode it is required to switch the machine off and on to activate normal operation.

Note: Under Standby and Shutdown displays are disabled.

Advanced Menu – Device Configuration Menu.









Note: To access to advanced menu:

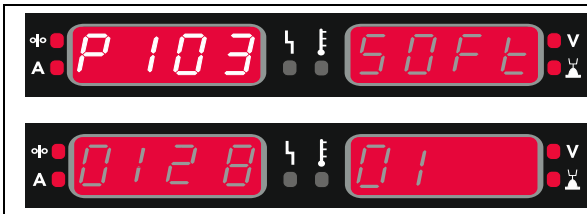
- In Base Menu select the Advanced Menu (Adv).
- Use the right button to confirm the selection.

Advanced Menu (Device Configuration Menu)

The Advanced Menu includes the parameters described in Table 7.

Table 7 The default settings of Advanced Menu

Parametr	Definicija
	<p>The Menu Exit – enables exit from menu.</p> <p>Note: This parameter cannot be edited.</p> <p>To exit from menu:</p> <ul style="list-style-type: none"> In Advanced Menu select P000. Confirm the selection, push the right button.
	<p>Wire Feed Speed (WFS) units – enables change WFS units:</p> <ul style="list-style-type: none"> CE (factory default) = m/min; US = in/min.
	<p>Crater Delay - this option is used to skip the Crater sequence when making short tack welds. If the trigger is released before the timer expires, Crater will be bypassed and the weld will end. If the trigger is released after the timer expires, the Crater sequence will function normally (if enabled).</p> <ul style="list-style-type: none"> OFF (0) to 10.0 seconds (default = OFF)
	<p>Arc Start/Loss Error Time - This option can be used to optionally shut off output if an arc is not established, or is lost for a specified of time. Error 269 will be displayed if the machine times out. If the value is set to OFF, machine output will not be turned off if an arc is not established or arc is lost. The trigger can be used to hot feed the wire (default). If a value is set, the machine output will shut off if an arc is not established within the specified amount of time after the trigger is pulled or if the trigger remains pulled after an arc is lost. To prevent nuisance errors, set Arc Start/Loss Error Time to an appropriate value after considering all welding parameters (run-in wire feed speed, weld wire feed speed, electrical stick out, etc).</p> <ul style="list-style-type: none"> OFF (0) to 10.0 seconds (default = Off) <p>Note: This parameter is disabled while welding in Stick, TIG or Gouge.</p>
	<p>Feedback Persist – determines how feedback values are displayed following a weld:</p> <ul style="list-style-type: none"> "No" (factory default) – last recorded feedback values will blink for 5 seconds following a weld, then return to present display mode. "Yes" – last recorded feedback values will blink indefinitely following a weld until a Control or Button is touched, or an arc is struck.
	<p>Brightness Control - enables the brightness level.</p> <ul style="list-style-type: none"> Adjust range: from 1 to +10, where 5 is default.
	<p>Restore Factory Settings – to restore Factory Settings:</p> <ul style="list-style-type: none"> Use the right button to confirm the selection. Use the right control to select "YES". Use the right button to confirm the selection. <p>Note: After the device has been restarted the P097 is "NO".</p>
	<p>Show Test Modes– uses for calibration and tests. To use the Test Modes:</p> <ul style="list-style-type: none"> On the right display is shown "LOAD". Use the right button to confirm the selection. On the right display is shown "DONE" <p>Note: After the device has been restarted the P099 is "LOAD".</p>



View Software Version Info – used for viewing the software versions for user interface.

To read the software version:

- In Advanced Menu select P103.
- Confirm the selection, push the right button.
- The displays will show the software version.

Note: P103 is a diagnostic parameter, to read only.

User Interface Advanced (U7)

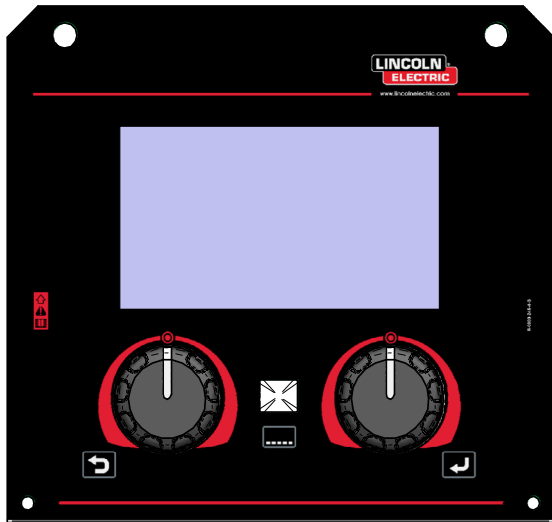


Figure 12

Detailed operation of User Interface U7 can be found in the Advanced (U7) IM3170 user manual.

Welding SMAW Process

POWERTEC® i250C STANDARD / ADVANCED, POWERTEC® i320C STANDARD / ADVANCED, POWERTEC® i380C ADVANCED, POWERTEC® i450C ADVANCED does not include the electrode holder with lead necessary for SMAW welding, but the one can be purchased separately (see "Accessories" chapter).

Procedure of begin welding of SMAW process:

- First turn the machine off.
- Determine the electrode polarity for the electrode to be used. Consult the electrode data for this information.
- Depending on the polarity of using electrode, connect the work lead [19] and the electrode holder with lead to output socket [2] or [3] and lock them. See the Table 8.

Table 8 Polarity

		Output Socket		
POLARITY	DC (+)	The electrode holder with lead to SMAW	[3]	+
		Work lead	[2]	-
	DC (-)	The electrode holder with lead to SMAW	[2]	-
		Work lead	[3]	+

- Connect the work lead to the welding piece with the work clamp.
- Install the proper electrode in the electrode holder.
- Turn the machine on.
- Set the SMAW welding program.
- Set the welding parameters.
- The welding machine is now ready to weld.
- By applying the principle of occupational health and safety at welding, welding can be begun.

For SMAW process user can set:

- Welding Current
- Switch on / switch off the output voltage on the output lead.
- Wave Control:
 - Arc Force
 - Hot Start

Welding GMAW and FCAW Process in non-synergic mode

During non-synergic mode wire feed speed and welding voltage are independent parameters and must be set by the user.

Procedure of begin welding of GMAW or FCAW-SS process:

- Determine the wire polarity for the wire to be used. Consult the wire data for this information.
- Connect output the gas-cooled gun to GMAW / FCAW process to Euro Socket [4].
- Depending on the using wire, connect the work lead [19] to output socket [2] or [3]. See [27] point – terminal block of changing polarity.
- Connect the work lead [19] to the welding piece with the work clamp.
- Install the proper wire.
- Install the proper drive rolls.
- Make a sure if it is needed (GMAW, FACW-GS process), that the gas shield has been connected.
- Turn the machine on.
- Push the gun trigger to feed the wire through the gun liner until the wire comes out of the threaded end.
- Install a proper contact tip.
- Depending on the welding process and the type of the gun, install the nozzle (GMAW process) or protection cap (FCAW process).
- Check gas flow with Gas Purge Switch [25].
- Close the side panel.
- Set the welding parameters.

WARNING

The side panel has to be completely closed during welding.

WARNING

Never use defected gun.

WARNING

Keep the gun cable as straight as possible when welding or loading electrode through cable.

WARNING

Do not kink or pull cable around sharp corners.

- The welding machine is now ready to weld.
- By applying the principle of occupational health and safety at welding, welding can be begun.

For non-synergic mode can set:

- Wire Feed Speed, WFS
- The welding voltage
- Burnback Time
- Run-in WFS
- Preflow Time/ Postflow Time
- Spot Time
- 2-Step/4-Step
- Start Procedure
- Crater Procedure
- Wave Control: Pinch

Welding GMAW and FCAW Process in synergic mode CV

In synergic mode, the welding voltage is not set by user. The correct welding voltage will be set by the machine software. Optimal voltage value depends of input data:

- Wire Feed Speed, WFS.

If it is needed, the welding voltage can be adjusted by the right knob [36]. When the right knob is rotated, the display will show a positive or negative bar that indicates if the voltage is above or below the optimal voltage.

Additionally user can manually set:

- Burnback Time
- Run-in WFS
- Preflow Time
- Postflow Time
- Spot Welding Settings
- 2-Step/4-Step
- Start Procedure
- Crater Procedure
- Wave Control: Pinch

Loading the Electrode Wire

Depending on the type of wire spool it can be installed on the wire spool support without adapter or installed with use applicable adapter that must be purchased separately (see "Accessories" chapter).

WARNING

Turn the input power OFF at the welding power source before installation or changing a wire spool.

- Turn the input power OFF.
- Open the side panel of the machine.
- Unscrew the Locking Nut [46] and remove it from the Spindle.
- Place the spool [23] on the Spindle [24] making certain the Spindle Brake Pin is put in the hole in back side of spool.

If using adapter (see "Accessories" chapter), place it on the spindle [24] making certain the spindle brake pin is put in the hole in back side of the adapter.

WARNING

Position the spool so that it will rotate in the same direction as wire feed and electrode wire should feed from the bottom side of the spool.

- Install the Locking Nut [46]. Make sure that the Locking Nut is tightened.

Adjustments of Brake Torque of Sleeve

To avoid spontaneous unrolling of the welding wire the sleeve is fitted with a brake.

Adjustment is carried by rotation of its screw M10, which is placed inside of the sleeve frame after unscrewing the brake locking nut.

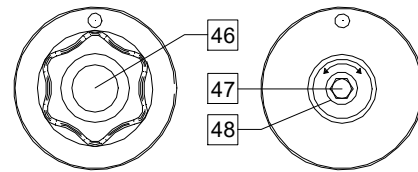


Figure 13

- 46. Locking Nut.
- 47. Adjusting Screw M10.
- 48. Pressing Spring.

Turning the M10 screw clockwise increases the spring tension and increase the brake torque

Turning the M10 screw anticlockwise decreases the spring tension and decrease the brake torque.

After finishing of adjustment, you should screw brake locking nut again.

Adjusting of Pressure Roll Force

The pressure arm controls the amount of force the drive rolls exert on the wire. Pressure force is adjusted by turning the adjustment nut clockwise to increase force, counterclockwise to decrease force. Proper adjustment of pressure arm gives the best welding performance.

WARNING

If the roll pressure is too weak the roll will slide on the wire. If the roll pressure is set too heavy the wire may be deformed, which cause feeding problems in the welding. The pressure force should be set properly. For this purpose decrease the pressure force slowly until the wire just begins to slide on the drive roll and then increase the force slightly by turning of the adjustment nut by one turn.

Inserting Electrode Wire into Welding Torch

- Turn the welding machine off.
- Depending of welding process connect proper welding torch to the euro socket. Rated parameters of the torch and welding machine should be matched.
- Depends on type of gun must be remove the nozzle from the gun and contact tip or protection cap and contact tip.
- Turn the welding machine on.
- Hold the Cold Inch / Gas Purge Switch [25] or use torch trigger until wire appear over threaded end of the gun.
- When the Cold Feed switch or torch trigger is released spool of wire should not unwind.
- Adjust wire spool brake accordingly.
- Turn the welding machine off.
- Install a proper contact tip.
- Depending on the welding process and the type of the gun, install the nozzle (GMAW process) or protection cap (FCAW process).

WARNING

Take precaution to keep eyes and hands away from the end of the gun while the wire is being come out of the threaded end.

Changing Driving Rolls

WARNING

Turn the input power off before installation or changing drive rolls.

POWERTEC® i250C STANDARD, POWERTEC® i250C ADVANCED, POWERTEC® i320C STANDARD, POWERTEC® i320C ADVANCED, POWERTEC® i380C ADVANCED, POWERTEC® i450C ADVANCED are equipped with drive roll V1.0/V1.2 for steel wire. For others wires and sizes it is required to install proper drive rolls kit (see "Accessories" chapter) and follow instruction:

- Turn the input power OFF.
- Unlock 4 rolls by turning 4 Quick-Change Carrier Gear [53].
- Release the pressure roll levers [54].
- Change the drive rolls [52] corresponding to the used wire.

WARNING

Be sure that the gun liner and contact tip are also size to match the selected wire size.

WARNING

For wires with the diameter larger than 1.6mm, the following parts have to be changed:

- The guide tube of the feeding console [50] and [51].
- The guide tube of the Euro Socket [49].
- Lock 4 new rolls by turning 4 Quick-Change Carrier Gear [53].
- Insert the wire through the guide tube, over the roller and through the guide tube of Euro Socket into liner of gun. The wire can be pushed into the liner manually for a few centimeters, and should feed easily and without any force.
- Lock the pressure roll levers [54].

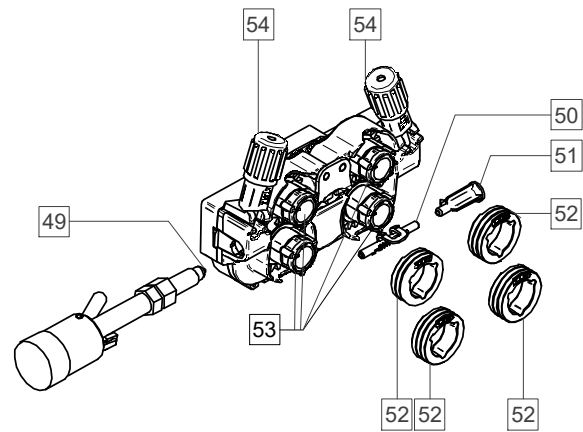


Figure 14

Gas Connection

WARNING



- CYLINDER may explode if damaged.
- Always fix the gas cylinder securely in an upright position, against a cylinder wall rack or purpose-made cylinder cart.
- Keep cylinder away from areas where it may be damaged, heated or electrical circuits to prevent possible explosion or fire.
- Keep cylinder away from welding or other live electrical circuits.
- Never lift welder with cylinder attached.
- Never allow welding electrode to touch cylinder.
- Build up of shielding gas may harm health or kill. Use in a well-ventilated area to avoid gas accumulation.
- Close the gas cylinder valves thoroughly when not in use to avoid leaks.

WARNING

Welding machine supports all suitable shielding gases at a maximum pressure of 5,0 bar.

WARNING

Before use, make sure that the gas cylinder contains gas suitable for the intended purpose.

- Turn off input power at the welding power source.
- Install a proper gas flow regulator to the gas cylinder.
- Connect the gas hose to the regulator using the hose clamp.
- The other end of gas hose connect to the gas connector on the power source rear panel.
- Turn on input power at the welding power source.
- Open the gas cylinder valve.
- Adjust the shielding gas flow of the gas regulator.
- Check gas flow with Gas Purge Switch [25].

WARNING

To weld GMAW process with CO₂ shielding gas, CO₂ gas heater should be used.

Transport & Lifting



! WARNING

Falling equipment can cause injury and damage to unit.

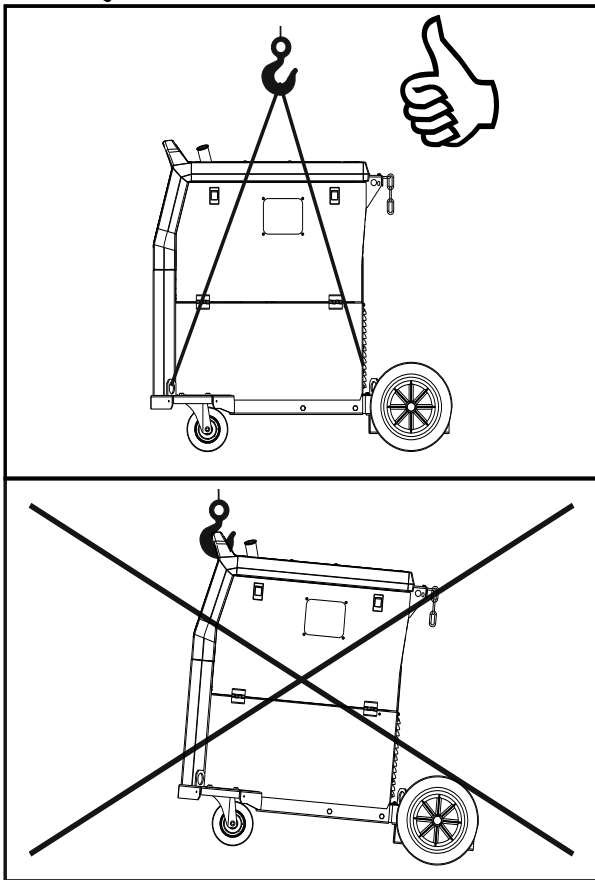


Figure 15.

During transportation and lifting with a crane, adhere to the following rules:

- The device contains elements adapted for transport.
- For lifting a suitable lifting equipment capacity.
- For lifting and transport use minimum four belts.
- Lift and transport only power source without gas cylinder, cooler, or/and any other accessories.

Maintenance

! WARNING

For any repair operations, modifications or maintenances, it is recommended to contact the nearest Technical Service Center or Lincoln Electric. Repairs and modifications performed by unauthorized service or personnel will cause, that the manufacturer's warranty will be lost.

Any noticeable damage should be reported immediately and repaired.

Routine maintenance (everyday)

- Check condition of insulation and connections of the work leads and insulation of power lead. If any insulation damage exists replace the lead immediately.
- Remove the spatters from the welding gun nozzle. Spatters could interfere with the shielding gas flow to the arc.
- Check the welding gun condition: replace it, if necessary.
- Check condition and operation of the cooling fan. Keep clean its airflow slots.

Periodic maintenance (every 200 working hours but at least once a year)

Perform the routine maintenance and, in addition:

- Keep the machine clean. Using a dry (and low pressure) airflow, remove the dust from the external case and from the cabinet inside.
- If it is required, clean and tighten all weld terminals.

The frequency of the maintenance operations may vary in accordance with the working environment where the machine is placed.

! WARNING

Do not touch electrically live parts.

! WARNING

Before removed case, machine has to be turned off and the power lead has to be disconnected from mains socket.

! WARNING

Mains supply network must be disconnected from the machine before each maintenance and service. After each repair, perform proper tests to ensure safety.

Customer Assistance Policy

The business of The Lincoln Electric Company is manufacturing and selling high quality welding equipment, consumables, and cutting equipment. Our challenge is to meet the needs of our customers and to exceed their expectations. On occasion, purchasers may ask Lincoln Electric for advice or information about their use of our products. We respond to our customers based on the best information in our possession at that time. Lincoln Electric is not in a position to warrant or guarantee such advice, and assumes no liability, with respect to such information or advice. We expressly disclaim any warranty of any kind, including any warranty of fitness for any customer's particular purpose, with respect to such information or advice. As a matter of practical consideration, we also cannot assume any responsibility for updating or correcting any such information or advice once it has been given, nor does the provision of information or advice create, expand or alter any warranty with respect to the sale of our products.

Lincoln Electric is a responsive manufacturer, but the selection and use of specific products sold by Lincoln Electric is solely within the control of, and remains the sole responsibility of the customer. Many variables beyond the control of Lincoln Electric affect the results obtained in applying these types of fabrication methods and service requirements.

Subject to Change – This information is accurate to the best of our knowledge at the time of printing. Please refer to www.lincolnelectric.com for any updated information.

WEEE

07/06



Do not dispose of electrical equipment together with normal waste!

In observance of European Directive 2012/19/EC on Waste Electrical and Electronic Equipment (WEEE) and its implementation in accordance with national law, electrical equipment that has reached the end of its life must be collected separately and returned to an environmentally compatible recycling facility. As the owner of the equipment, you should get information on approved collection systems from our local representative.

By applying this European Directive you will protect the environment and human health!

Spare Parts

12/05

Part List reading instructions

- Do not use this part list for a machine if its code number is not listed. Contact the Lincoln Electric Service Department for any code number not listed.
- Use the illustration of assembly page and the table below to determine where the part is located for your particular code machine.
- Use only the parts marked "X" in the column under the heading number called for in the assembly page (# indicate a change in this printing).

First, read the Part List reading instructions above, then refer to the "Spare Part" manual supplied with the machine that contains a picture-descriptive part number cross-reference.

Authorized Service Shops Location

09/16

- The purchaser must contact a Lincoln Authorized Service Facility (LASF) about any defect claimed under Lincoln's warranty period.
- Contact your local Lincoln Sales Representative for assistance in locating a LASF or go to www.lincolnelectric.com/en-gb/Support/Locator.

Electrical Schematic

Refer to the "Spare Part" manual supplied with the machine.

Accessories

K14201-1	CABLE MANAGEMENT KIT
K14325-1	DISPLAY COVER KIT LE
K14328-1	BUMPERS
K10095-1-15M	REMOTE CONTROL
K2909-1	6-PIN/12-PIN ADAPTER
K14290-1	12PIN REMOTE HARNESS KIT
K14173-1	POLARITY CHANGE KIT
K14175-1	GAS FLOW METER KIT
K14176-1	GAS HEATER KIT
K14182-1	COOLER COOLARC 26
K14204-1	WIRE FEEDER DRUM QUICK CONNECTOR
K14325-1	CONTROL PANEL COVER KIT
R-1019-125-1/08R	ADAPTER FOR SPOOL S200
K10158-1	ADAPTER FOR SPOOL TYPE B300
K10158	ADAPTER FOR SPOOL 300mm
E/H-300A-50-XM	WELDING CABLE WITH ELECTRODE HOLDER 300A (X=5, 10m)
E/H-400A-70-XM	WELDING CABLE WITH ELECTRODE HOLDER 400A (X=5, 10m)
MIG/MAG TORCHES	
W10429-36-3M	LGS2 360 G-3.0M MIG GUN AIR COOLED
W10429-36-4M	LGS2 360 G-4.0M MIG GUN AIR COOLED
W10429-36-5M	LGS2 360 G-5.0M MIG GUN AIR COOLED
W10429-505-3M	LGS2 505W 3.0M MIG GUN WATER COOLED
W10429-505-4M	LGS2 505W 4.0M MIG GUN WATER COOLED
W10429-505-5M	LGS2 505W 5.0M MIG GUN WATER COOLED
ROLL KIT FOR SOLID WIRES	
KP14150-V06/08	ROLL KIT 0.6/0.8VT FI37 4PCS GREEN/BLUE
KP14150-V08/10	ROLL KIT 0.8/1.0VT FI37 4PCS BLUE/RED
KP14150-V10/12	ROLL KIT 1.0/1.2VT FI37 4PCS RED/ORANGE
KP14150-V12/16	ROLL KIT 1.2/1.6VT FI37 4PCS ORANGE/YELL
KP14150-V16/24	ROLL KIT 1.6/2.4VT FI37 4PCS YELL/GREY
KP14150-V09/11	ROLL KIT 0.9/1.1VT FI37 4PCS
KP14150-V14/20	ROLL KIT 1.4/2.0VT FI37 4PCS
ROLL KIT FOR ALUMINIUM WIRES	
KP14150-U06/08A	ROLL KIT 0.6/0.8AT FI37 4PCS GREEN/BLUE
KP14150-U08/10A	ROLL KIT 0.8/1.0AT FI37 4PCS BLUE/RED
KP14150-U10/12A	ROLL KIT 1.0/1.2AT FI37 4PCS RED/ORANGE
KP14150-U12/16A	ROLL KIT 1.2/1.6AT FI37 4PCS ORANGE/YELL
KP14150-U16/24A	ROLL KIT 1.6/2.4AT FI37 4PCS YELL/GREY
ROLL KIT FOR CORED WIRES	
KP14150-V12/16R	ROLL KIT 1.2/1.6RT FI37 4PCS ORANGE/YELL
KP14150-V14/20R	ROLL KIT 1.4/2.0RT FI37 4PCS
KP14150-V16/24R	ROLL KIT 1.6/2.4RT FI37 4PCS YELL/GREY
KP14150-V09/11R	ROLL KIT 0.9/1.1RT FI37 4PCS
KP14150-V10/12R	ROLL KIT 1.0/1.2RT FI37 4PCS -/ORANGE

WIRE GUIDES	
0744-000-318R	WIRE GUIDE SET BLUE Ø0.6-1.6
0744-000-319R	WIRE GUIDE SET RED Ø1.8-2.8
D-1829-066-4R	EURO WIRE GUIDE Ø0.6-1.6
D-1829-066-5R	EURO WIRE GUIDE Ø1.8-2.8

Dimension Diagram

