

CRX COBOT CART



THANK YOU FOR SELECTING A QUALITY PRODUCT BY LINCOLN ELECTRIC.

PLEASE EXAMINE CARTON AND EQUIPMENT FOR DAMAGE IMMEDIATELY

When this equipment is shipped, title passes to the purchaser upon receipt by the carrier. Consequently, claims for material damaged in shipment must be made by the purchaser against the transportation company at the time the shipment is received.

SAFETY DEPENDS ON YOU

Lincoln arc welding and cutting equipment is designed and built with safety in mind. However, your overall safety depends upon proper installation and thoughtful operation on your part. **DO NOT INSTALL, OPERATE OR REPAIR THIS EQUIPMENT WITHOUT READING THIS MANUAL AND THE SAFETY PRECAUTIONS CONTAINED THROUGHOUT.** And, most importantly, think before you act and be careful.

WARNING

This statement appears where the information must be followed exactly to avoid serious personal injury or loss of life.

CAUTION

This statement appears where the information must be followed to avoid minor personal injury or damage to this equipment.

KEEP YOUR HEAD OUT OF THE FUMES.

DON'T get too close to the arc. Use corrective lenses if necessary to stay a reasonable distance away from the arc.

READ and obey the Safety Data Sheet (SDS) and the warning label that appear on all containers of welding materials.

USE ENOUGH VENTILATION or exhaust at the arc, or both, to keep the fumes and gases from your breathing zone and the general area.

If you have questions about safe working procedures or develop unusual symptoms, see your supervisor. Regularly check and maintain equipment and exhaust systems.



WEAR CORRECT EYE, EAR & BODY PROTECTION



PROTECT your eyes and face with welding helmet properly fitted and with proper grade of filter plate (See ANSI Z49.1).

PROTECT your body from welding spatter and arc flash with protective clothing including woolen clothing, flame-proof apron and gloves, leather leggings, and high boots.

PROTECT others from splatter, flash, and glare with protective screens or barriers.

IN SOME AREAS, protection from noise may be appropriate.

BE SURE protective equipment is in good condition.  Also, wear safety glasses in work areas **AT ALL TIMES.**

SPECIAL SITUATIONS

DO NOT WELD OR CUT containers or materials which previously had been in contact with hazardous substances unless they are properly cleaned. This is extremely dangerous.

DO NOT WELD OR CUT painted or plated parts unless special precautions with ventilation have been taken. They can release highly toxic fumes or gases.

Additional precautionary measures

PROTECT compressed gas cylinders from excessive heat, mechanical shocks, and arcs; fasten cylinders so they cannot fall.

BE SURE cylinders are never grounded or part of an electrical circuit.

REMOVE all potential fire hazards from welding area.

ALWAYS HAVE FIRE FIGHTING EQUIPMENT READY FOR IMMEDIATE USE AND KNOW HOW TO USE IT.

REFER TO AND FOLLOW NFPA 51B.





SECTION A: WARNINGS



CALIFORNIA PROPOSITION 65 WARNINGS



WARNING: Breathing diesel engine exhaust exposes you to chemicals known to the State of California to cause cancer and birth defects, or other reproductive harm.

- Always start and operate the engine in a well-ventilated area.
- If in an exposed area, vent the exhaust to the outside.
- Do not modify or tamper with the exhaust system.

WARNING: This product, when used for welding or cutting, produces fumes or gases which contain chemicals known to the State of California to cause birth defects and, in some cases, cancer. (California Health & Safety Code § 25249.5 *et seq.*)



WARNING: Cancer and Reproductive Harm www.P65warnings.ca.gov



ARC WELDING CAN BE HAZARDOUS. PROTECT YOURSELF AND OTHERS FROM POSSIBLE SERIOUS INJURY OR DEATH. KEEP CHILDREN AWAY. PACEMAKERS AND OTHER MEDICAL IMPLANT DEVICES WEARERS SHOULD CONSULT WITH THEIR DOCTOR BEFORE OPERATING.

Read and understand the following safety highlights. For additional safety information, it is strongly recommended that you purchase a copy of "Safety in Welding & Cutting - ANSI Standard Z49.1" from the American Welding Society, P.O. Box 351040, Miami, Florida 33135 or CSA Standard W117.2-1974. A Free copy of "Arc Welding Safety" booklet E205 is available from the Lincoln Electric Company, 22801 St. Clair Avenue, Cleveland, Ohio 44117-1199.



BE SURE THAT ALL INSTALLATION, OPERATION, MAINTENANCE AND REPAIR PROCEDURES ARE PERFORMED ONLY BY QUALIFIED INDIVIDUALS.



FOR ENGINE POWERED EQUIPMENT.

- 1.a. Turn the engine off before troubleshooting and maintenance work unless the maintenance work requires it to be running. 
- 1.b. Operate engines in open, well-ventilated areas or vent the engine exhaust fumes outdoors.
- 1.c. Do not add the fuel near an open flame welding arc or when the engine is running. Stop the engine and allow it to cool before refueling to 

prevent spilled fuel from vaporizing on contact with hot engine parts and igniting. Do not spill fuel when filling tank. If fuel is spilled, wipe it up and do not start engine until fumes have been eliminated.

- 1.d. Keep all equipment safety guards, covers and devices in position and in good repair. Keep hands, hair, clothing and tools away from V-belts, gears, fans and all other moving parts when starting, operating or repairing equipment. 
- 1.e. In some cases it may be necessary to remove safety guards to perform required maintenance. Remove guards only when necessary and replace them when the maintenance requiring their removal is complete. Always use the greatest care when working near moving parts.
- 1.f. Do not put your hands near the engine fan. Do not attempt to override the governor or idler by pushing on the throttle control rods while the engine is running.
- 1.g. To prevent accidentally starting gasoline engines while turning the engine or welding generator during maintenance work, disconnect the spark plug wires, distributor cap or magneto wire as appropriate.
- 1.h. To avoid scalding, do not remove the radiator pressure cap when the engine is hot. 



ELECTRIC AND MAGNETIC FIELDS MAY BE DANGEROUS



- 2.a. Electric current flowing through any conductor causes localized Electric and Magnetic Fields (EMF). Welding current creates EMF fields around welding cables and welding machines
- 2.b. EMF fields may interfere with some pacemakers, and welders having a pacemaker should consult their physician before welding.
- 2.c. Exposure to EMF fields in welding may have other health effects which are now not known.
- 2.d. All welders should use the following procedures in order to minimize exposure to EMF fields from the welding circuit:
 - 2.d.1. Route the electrode and work cables together - Secure them with tape when possible.
 - 2.d.2. Never coil the electrode lead around your body.
 - 2.d.3. Do not place your body between the electrode and work cables. If the electrode cable is on your right side, the work cable should also be on your right side.
 - 2.d.4. Connect the work cable to the workpiece as close as possible to the area being welded.
 - 2.d.5. Do not work next to welding power source.



ELECTRIC SHOCK CAN KILL.



- 3.a. The electrode and work (or ground) circuits are electrically “hot” when the welder is on. Do not touch these “hot” parts with your bare skin or wet clothing. Wear dry, hole-free gloves to insulate hands.
- 3.b. Insulate yourself from work and ground using dry insulation. Make certain the insulation is large enough to cover your full area of physical contact with work and ground.

In addition to the normal safety precautions, if welding must be performed under electrically hazardous conditions (in damp locations or while wearing wet clothing; on metal structures such as floors, gratings or scaffolds; when in cramped positions such as sitting, kneeling or lying, if there is a high risk of unavoidable or accidental contact with the workpiece or ground) use the following equipment:
 - Semiautomatic DC Constant Voltage (Wire) Welder.
 - DC Manual (Stick) Welder.
 - AC Welder with Reduced Voltage Control.
- 3.c. In semiautomatic or automatic wire welding, the electrode, electrode reel, welding head, nozzle or semiautomatic welding gun are also electrically “hot”.
- 3.d. Always be sure the work cable makes a good electrical connection with the metal being welded. The connection should be as close as possible to the area being welded.
- 3.e. Ground the work or metal to be welded to a good electrical (earth) ground.
- 3.f. Maintain the electrode holder, work clamp, welding cable and welding machine in good, safe operating condition. Replace damaged insulation.
- 3.g. Never dip the electrode in water for cooling.
- 3.h. Never simultaneously touch electrically “hot” parts of electrode holders connected to two welders because voltage between the two can be the total of the open circuit voltage of both welders.
- 3.i. When working above floor level, use a safety belt to protect yourself from a fall should you get a shock.
- 3.j. When not welding, make certain no part of the electrode circuit is touching the work or ground. Accidental contact can cause overheating and create a fire hazard. Also refer to paragraph 8.



ARC RAYS CAN BURN.



- 4.a. Use a shield with the proper filter and cover plates to protect your eyes from sparks and the rays of the arc when welding or observing open arc welding. Headshield and filter lens should conform to ANSI Z87.1, Section 4 standards.
- 4.b. Use suitable clothing made from durable flame-resistant material to protect your skin and that of your helpers from the arc rays.
- 4.c. Protect other nearby personnel with suitable, non-flammable screening and/or warn them not to watch the arc nor expose themselves to the arc rays or to hot spatter or metal.
- 4.d. The International Agency for Research on Cancer (IARC) has determined that ultraviolet radiation from welding are carcinogenic to humans.



FUMES AND GASES CAN BE DANGEROUS.

- 5.a. FUMES AND GASES can be hazardous to your health.
 - Fumes from the normal use of this product contain significant quantities of potentially hazardous compounds. See consumable product label/insert.
 - Keep your head out of fumes.
 - An approved respirator should be used unless exposure assessments are below applicable exposure limits.
 - The International Agency for Research on Cancer (IARC) has determined that welding fumes and ultraviolet radiation from welding are carcinogenic to humans.
- Welding may produce fumes and gases hazardous to health. Avoid breathing these fumes and gases. When welding, keep your head out of the fume. Use enough ventilation and/or exhaust at the arc to keep fumes and gases away from the breathing zone and keep exposure within applicable limits such as the OSHA PEL and ACGIH TLV. Wear a respirator and use local exhaust or mechanical ventilation unless exposure assessments indicate otherwise. Specific circumstances, such as confined spaces, could also require a respirator.**
- 5.b. The International Agency for Research on Cancer (IARC) has determined that welding fumes are carcinogenic to humans.
 - 5.c. The operation of welding fume control equipment is affected by various factors including proper use and positioning of the equipment, maintenance of the equipment and the specific welding procedure and application within applicable limits, such as the OSHA PEL and ACGIH TLV limits. Worker exposure level should be checked upon installation and periodically thereafter to be certain it is within applicable OSHA PEL and ACGIH TLV limits.
 - 5.d. Do not weld in locations near chlorinated hydrocarbon vapors coming from degreasing, cleaning or spraying operations. The heat and rays of the arc can react with solvent vapors to form phosgene, a highly toxic gas, and other irritating products.

- 5.e. Welding hardfacing (see instructions on container or SDS) or on lead or cadmium plated steel and other metals or coatings, can produce highly toxic fumes, and it is especially important to keep exposure as low as possible and within applicable OSHA PEL and ACGIH TLV limits. Additional precautions are also required when welding on galvanized steel.
- 5.f. Shielding gases used for arc welding and gases created during welding, can displace air and cause injury or death. Always use enough ventilation, especially in confined areas, to insure breathing air is safe.
- 5.g. Read and understand the manufacturer's instructions for this equipment and the consumables to be used, including the Safety Data Sheet (SDS) and follow your employer's safety practices. SDS forms are available from your welding distributor or from the manufacturer.
- 5.h. Do not add the fuel near an open flame welding arc or when the engine is running. Stop the engine and allow it to cool before refueling to prevent spilled fuel from vaporizing on contact with hot engine parts and igniting. Do not spill fuel when filling tank. If fuel is spilled, wipe it up and do not start engine until fumes have been eliminated.



WELDING AND CUTTING SPARKS CAN CAUSE FIRE OR EXPLOSION.

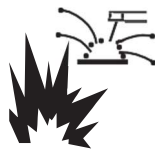

- 6.a. Remove fire hazards from the welding area. If this is not possible, cover them to prevent the welding sparks from starting a fire. Remember that welding sparks and hot materials from welding can easily go through small cracks and openings to adjacent areas. Avoid welding near hydraulic lines. Have a fire extinguisher readily available.
- 6.b. Where compressed gases are to be used at the job site, special precautions should be used to prevent hazardous situations. Refer to "Safety in Welding and Cutting" (ANSI Standard Z49.1) and the operating information for the equipment being used.
- 6.c. When not welding, make certain no part of the electrode circuit is touching the work or ground. Accidental contact can cause overheating and create a fire hazard.
- 6.d. Do not heat, cut or weld tanks, drums or containers until the proper steps have been taken to insure that such procedures will not cause flammable or toxic vapors from substances inside. They can cause an explosion even though they have been "cleaned". For information, purchase "Recommended Safe Practices for the Preparation for Welding and Cutting of Containers and Piping That Have Held Hazardous Substances", AWS F4.1 from the American Welding Society (see address above).
- 6.e. Vent hollow castings or containers before heating, cutting or welding. They may explode.
- 6.f. Sparks and spatter are thrown from the welding arc. Wear oil free protective garments such as leather gloves, heavy shirt, cuffless trousers, high shoes and a cap over your hair. Wear ear plugs when welding out of position or in confined places. Always wear safety glasses with side shields when in a welding area.
- 6.g. Connect the work cable to the work as close to the welding area as practical. Work cables connected to the building framework or other locations away from the welding area increase the possibility of the welding current passing through lifting chains, crane cables or other alternate circuits. This can create fire hazards or overheat lifting chains or cables until they fail.
- 6.h. Also see item 1.c.
- 6.i. Read and follow NFPA 51B "Standard for Fire Prevention During Welding, Cutting and Other Hot Work", available from NFPA, 1 Batterymarch Park, PO box 9101, Quincy, MA 022690-9101.
- 6.j. Do not use a welding power source for pipe thawing.



CYLINDER MAY EXPLODE IF DAMAGED.



- 7.a. Use only compressed gas cylinders containing the correct shielding gas for the process used and properly operating regulators designed for the gas and pressure used. All hoses, fittings, etc. should be suitable for the application and maintained in good condition.
- 7.b. Always keep cylinders in an upright position securely chained to an undercarriage or fixed support.
- 7.c. Cylinders should be located:
 - Away from areas where they may be struck or subjected to physical damage.
 - A safe distance from arc welding or cutting operations and any other source of heat, sparks, or flame.
- 7.d. Never allow the electrode, electrode holder or any other electrically "hot" parts to touch a cylinder.
- 7.e. Keep your head and face away from the cylinder valve outlet when opening the cylinder valve.
- 7.f. Valve protection caps should always be in place and hand tight except when the cylinder is in use or connected for use.
- 7.g. Read and follow the instructions on compressed gas cylinders, associated equipment, and CGA publication P-1, "Precautions for Safe Handling of Compressed Gases in Cylinders," available from the Compressed Gas Association, 14501 George Carter Way Chantilly, VA 20151.



FOR ELECTRICALLY POWERED EQUIPMENT.



- 8.a. Turn off input power using the disconnect switch at the fuse box before working on the equipment.
- 8.b. Install equipment in accordance with the U.S. National Electrical Code, all local codes and the manufacturer's recommendations.
- 8.c. Ground the equipment in accordance with the U.S. National Electrical Code and the manufacturer's recommendations.

For additional safety information refer to
<http://www.lincolnelectric.com/safety>



Electric Shock



Fumes & Gases



Fire & Explosions



Misc Welding Safety

Personal Protective
Equipment

ELECTROMAGNETIC COMPATIBILITY (EMC)

Conformance

Products displaying the CE mark are in conformity with European Community Council Directive of 15 Dec 2004 on the approximation of the laws of the Member States relating to electromagnetic compatibility, 2004/108/EC. It was manufactured in conformity with a national standard that implements a harmonized standard: EN 60974-10 Electromagnetic Compatibility (EMC) Product Standard for Arc Welding Equipment. It is for use with other Lincoln Electric equipment. It is designed for industrial and professional use.

Introduction

All electrical equipment generates small amounts of electromagnetic emission. Electrical emission may be transmitted through power lines or radiated through space, similar to a radio transmitter. When emissions are received by other equipment, electrical interference may result. Electrical emissions may affect many kinds of electrical equipment; other nearby welding equipment, radio and TV reception, numerical controlled machines, telephone systems, computers, etc.

Warning: This Class A equipment is not intended for use in residential locations where the electrical power is provided by the public low-voltage supply system. There may be potential difficulties in ensuring electro-magnetic compatibility in those locations, due to conducted as well as radiated disturbances.

Installation and use

The user is responsible for installing and using the welding equipment according to the manufacturer's instructions. If electromagnetic disturbances are detected then it shall be the responsibility of the user of the welding equipment to resolve the situation with the technical assistance of the manufacturer. In some cases this remedial action may be as simple as earthing (grounding) the welding circuit, see Note. In other cases it could involve constructing an electromagnetic screen enclosing the power source and the work complete with associated input filters. In all cases electromagnetic disturbances must be reduced to the point where they are no longer troublesome.

Note: The welding circuit may or may not be earthed for safety reasons. Follow your local and national standards for installation and use. Changing the earthing arrangements should only be authorized by a person who is competent to assess whether the changes will increase the risk of injury, e.g., by allowing parallel welding current return paths which may damage the earth circuits of other equipment.

Assessment of area

Before installing welding equipment the user shall make an assessment of potential electromagnetic problems in surrounding area. The following shall be taken into account:

- a) Other supply cables, control cables, signaling and telephone cables; above, below and adjacent to the welding equipment;
- b) Radio and television transmitters and receivers;
- c) Computer and other control equipment;
- d) Safety critical equipment, e.g., guarding of industrial equipment;
- e) The health of the people around, e.g., the use of pacemakers and hearing aids;
- f) Equipment used for calibration or measurement;

g) The immunity of other equipment in the environment. The user shall ensure that other equipment being used in the environment is compatible. This may require additional protection measures;

h) The time of day that welding or other activities are to be carried out. The size of the surrounding area to be considered will depend on the structure of the building and other activities that are taking place. The surrounding area may extend beyond the boundaries of the premises.

Methods of reducing emissions

Public supply system

Welding equipment should be connected to the public supply system according to the manufacturer's recommendations. If interference occurs, it may be necessary to take additional precautions such as filtering of the system. Consideration should be given to shielding the supply cable of permanently installed welding equipment, in metallic conduit or equivalent. Shielding should be electrically continuous throughout its length. The shielding should be connected to the welding power source so that good electrical contact is maintained between the conduit and the welding power source enclosure.

Maintenance of the welding equipment

The welding equipment should be routinely maintained according to the manufacturer's recommendations. All access and service doors and covers should be closed and properly fastened when the welding equipment is in operation. The welding equipment should not be modified in any way except for those changes and adjustments covered in the manufacturer's instructions. In particular, the spark gaps of arc striking and stabilizing devices should be adjusted and maintained according to the manufacturer's recommendations.

Welding cables

The welding cables should be kept as short as possible and should be positioned close together, running at or close to the floor level.

Equipotential bonding

Bonding of all metallic components in the welding installation and adjacent to it should be considered. However, metallic components bonded to the work piece will increase the risk that the operator could receive a shock by touching these metallic components and the electrode at the same time. The operator should be insulated from all such bonded metallic components.

Earthing of the workpiece

Where the workpiece is not bonded to earth for electrical safety, nor connected to earth because of its size and position, e.g., ship's hull or building steelwork, a connection bonding the workpiece to earth may reduce emissions in some, but not all instances. Care should be taken to prevent the earthing of the workpiece increasing the risk of injury to users, or damage to other electrical equipment. Where necessary, the connection of the workpiece to earth should be made by a direct connection to the workpiece, but in some countries where direct connection is not permitted, the bonding should be achieved by suitable capacitance, selected according to national regulations.

Screening and shielding

Selective screening and shielding of other cables and equipment in the surrounding area may alleviate problems of interference. Screening of the entire welding installation may be considered for special applications.

Table of Contents

Introduction	9
Intended or Proper use of the Equipment	9
Reasonably foreseeable misuse of the Equipment	10
Modification of This System	10
When Reading This Manual	10
Equipment Layout	12
Installation and Setup	17
Robot Operating Space	18
Power-up procedure and status indicator	19
Smart Torch Features	20
Home robot position and TP program	22
System Operation	23
Safety Features	31
Troubleshooting	32
Maintenance	33
Parts List	35
Optional Software and PAC processing	36
Customer Assistance Policy	45
Risk Assessment Definitions	46
CRX COBOT CART Risk Assessment	49

Introduction

CRX COBOT CART is a mobile robotic welding pushcart that incorporates FANUC CRX-10iA or 10iA/L collaborative robot. The system is designed to meet ANSI/RIA 15.06-2012 (ISO10218-2) specifications for equipment safety, employing a single operating zone. The robot has force sensors that trigger an immediate safety stop at the touch of a human body or any other object.

Intended or Proper use of the Equipment

This equipment is intended for use exclusively as a robotic system for metal inert gas shielded (MIG) welding of steel or aluminum components. These components are held in welding position by specifically designed tooling fixtures.

This equipment is intended to be used only in indoor environments. Models with casters should only be used in a leveled position, with all casters firmly on the floor in the locked/braked position. Certain models may be configured for transportation by cranes and/or forklifts, however, this system should never be operated while suspended or elevated.

Measures need to be taken to safeguard people who work with the system. The relevant safety measures that are taken must consider all risks and hazards that may arise when working with the robotic welding system. The end user has the responsibility to ensure a proper risk assessment of the System is performed prior to use. Lincoln Electric's risk assessment covering the foreseeable hazards of this System is attached at the end of this manual. The end user must consider all hazards and risks present in workplace where the System is operated and take appropriate safety measures, including those that may arise when working with this System.

End users must observe all safety guidelines instructions in the operating manual for this System, and in any component instruction manuals. Inspections and maintenance work should only be done by qualified individuals, who are also familiar with the safety and instruction literature.

Reasonably foreseeable misuse of the Equipment

Any procedure, other than what is specified in the “Intended or Proper use of the Equipment” section that goes beyond the above-mentioned “Intended or Proper use of the Equipment” is considered improper use. This includes, but not limited to, loading the robot at a higher weight and volume, providing different than what is specified incoming voltage, power feeder protection and capacity, attempts to weld with different materials other than steel or aluminum, or welding using different weld processes other than MIG.

No changes are permitted to be made to any part of this equipment if they would enable any type of misuse versus what is defined in the “Intended or Proper use of the Equipment” section.

Modification of This System

The system shall not be modified in any way. Modifications could affect its performance, safety or durability, increase risks of serious injury and/or death, and possibly violate ANSI/RIA 15.06-2012 safety requirements. In addition, damage or performance problems resulting from modification will not be covered under the Lincoln Electric warranties.

When Reading This Manual

This manual includes information for all options available on this type of equipment. Therefore, you may find some information that does not apply to your system. All information, specifications and illustrations in this manual are those in effect at the time of printing. Lincoln Electric reserves the right to change specifications or design at any time without notice.

Service and Technical Phone Support

	Hotline (8-5PM EST) 1-888-935-3878 (Ext3)
	After-Hours Hotline 1-888-532-8001 (Ext3)

Technical Specifications

Electrical Power Requirements:

Lincoln PowerWave R450 Welding Power Source:

Universal 3-phase self-adjusting power – this table has to be followed for cable sizing and protection devices selection:

RECOMMENDED INPUT WIRE AND FUSE SIZES ¹			
INPUT VOLTAGE / PHASE/ FREQUENCY	MAXIMUM INPUT AMPERE RATING AND DUTY CYCLE	CORD SIZE ³ AWG SIZES (mm²)	TIME DELAY FUSE OR BREAKER ² AMPERAGE
200-208/3/50/60	80A, 40%	4 (21)	100
230/3/50/60	73A, 40%	4 (21)	90
380-415/3/50/60	41A, 40%	8 (10)	60
460/3/50/60	37A, 40%	8 (10)	45
575/3/50/60	29A, 40%	10 (7)	35

Fanuc R-30iB PLUS MINI Robot Controller:

120 Volt single-phase power – plugged into a standard 15 or 20 Amperes utility outlet.

.....

A5003603 Lincoln Electric Automation Single Power Disconnect/Distribution box (if provided):

460 Volt 3-phase 60 Amperes power feed fused at 45 Amperes.

Provides power to:

- Lincoln PowerWave welder
- Fanuc robot controller
- Lincoln fume extractor

Equipment Layout

View 1 – Top:

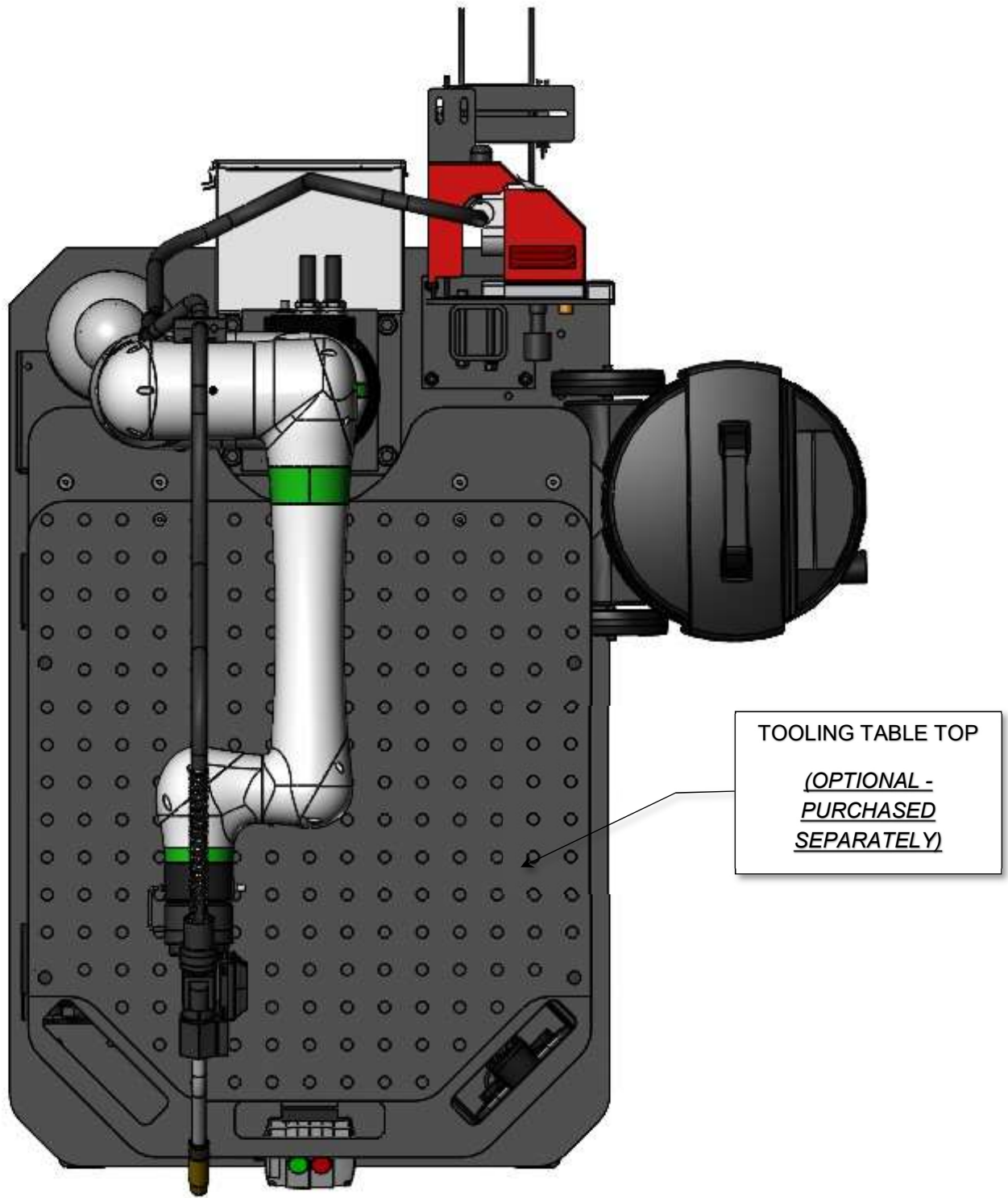

View 2 - Front:

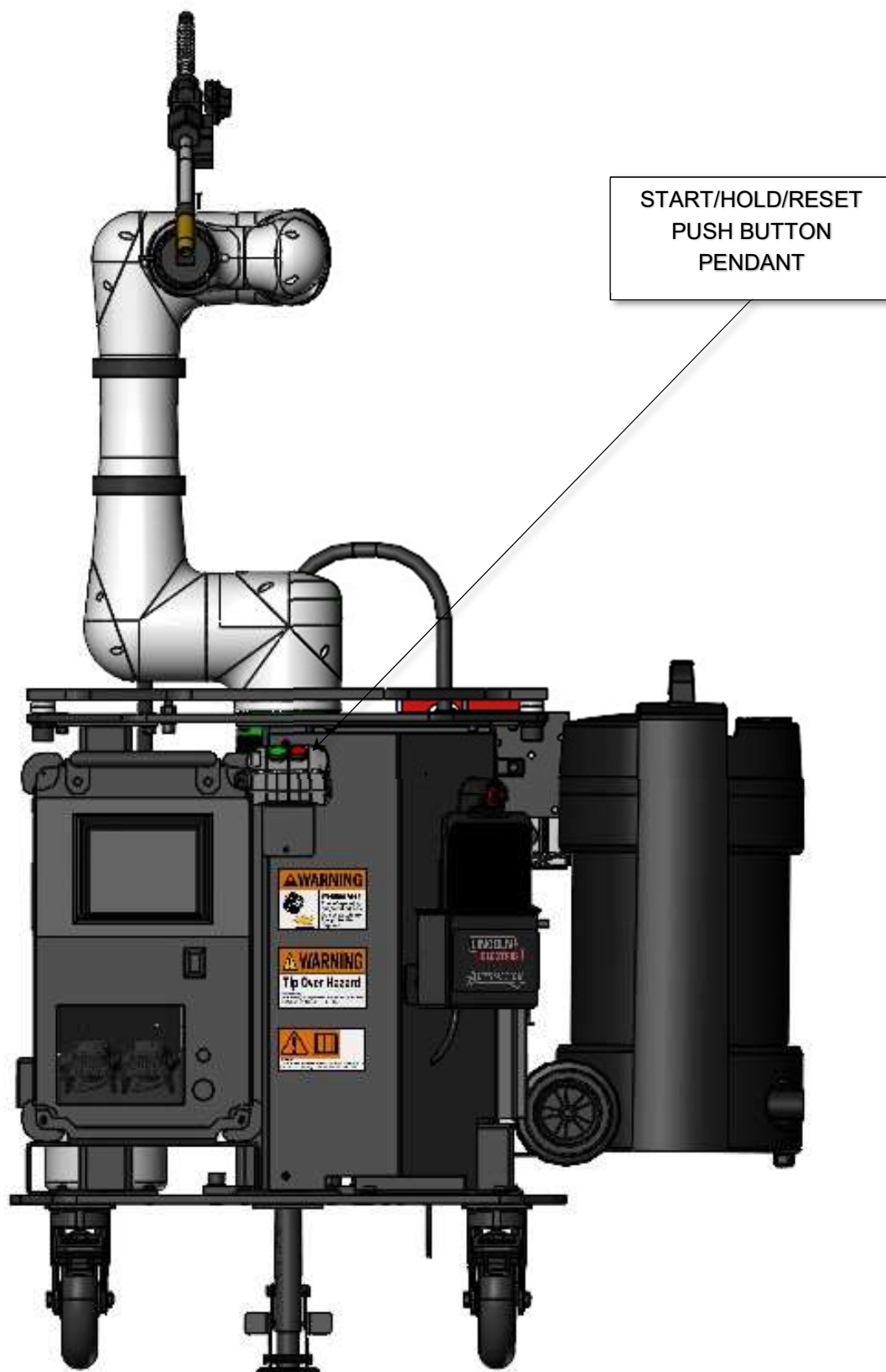

View 3 - Back:

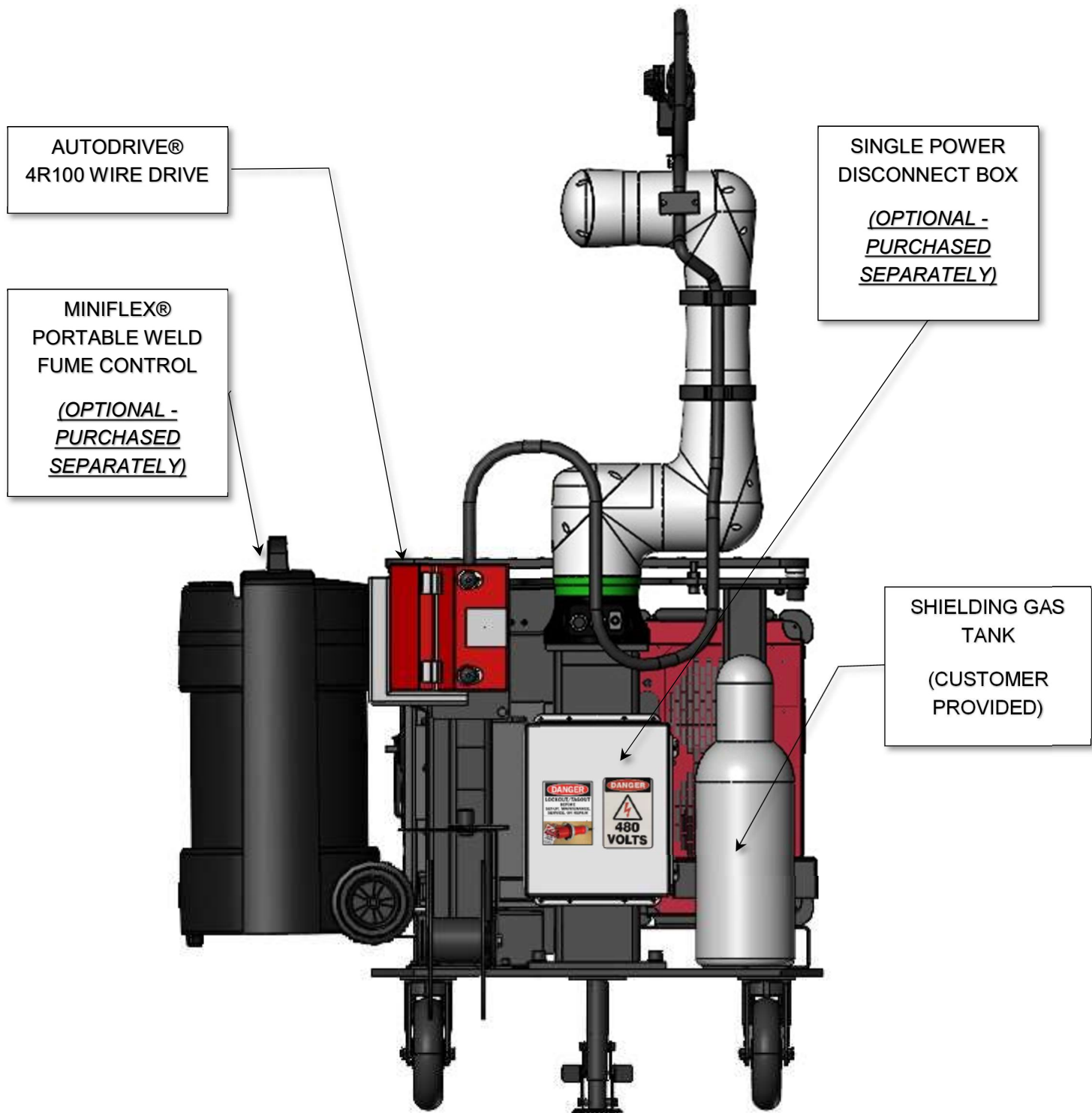

*Optional fume extraction unit is available for purchase. Follow unit's operating manual for proper use. End users are responsible for ensuring appropriate ventilation is in place.

View 4 – Right side:

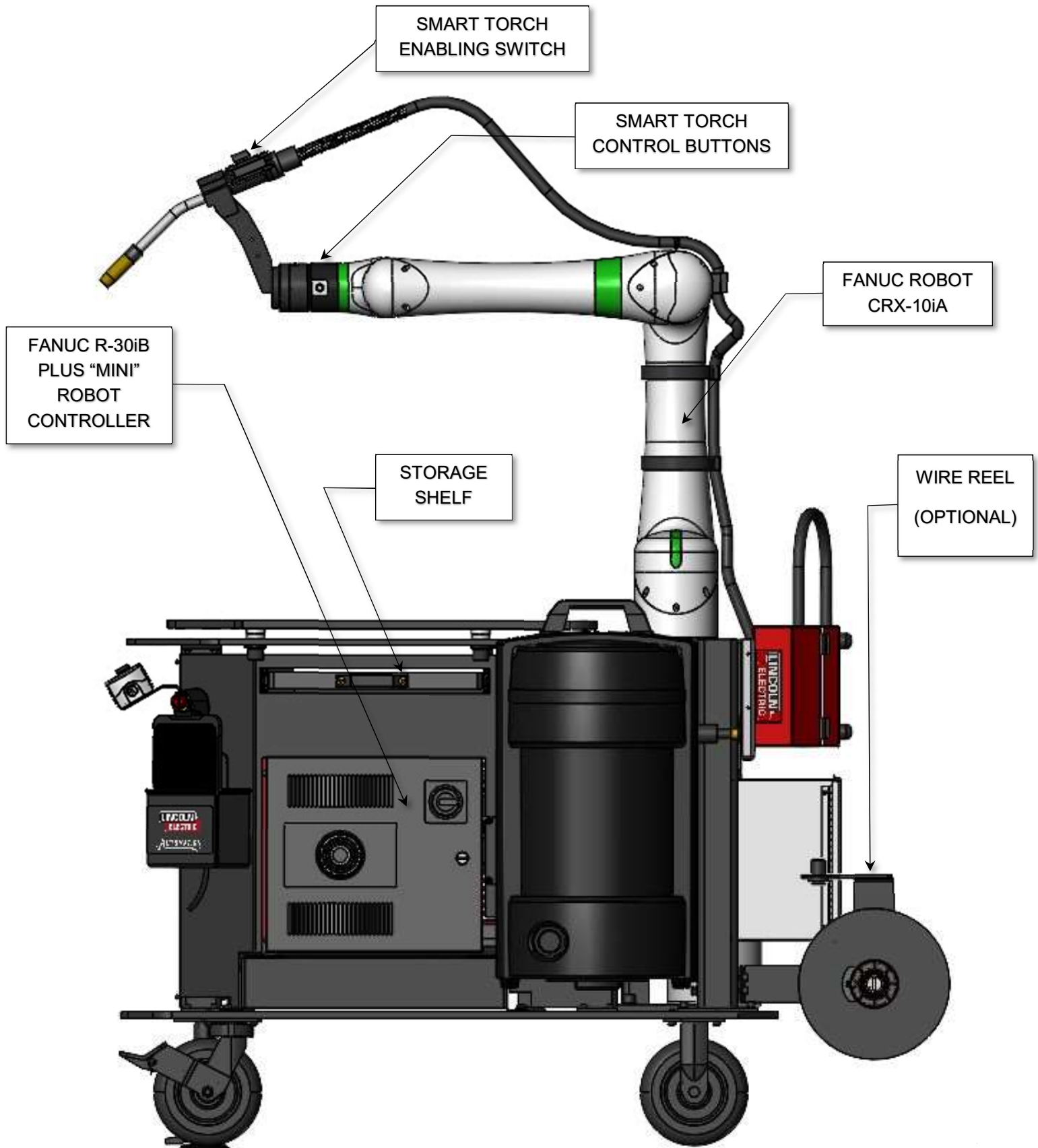

View 5 – Left side:

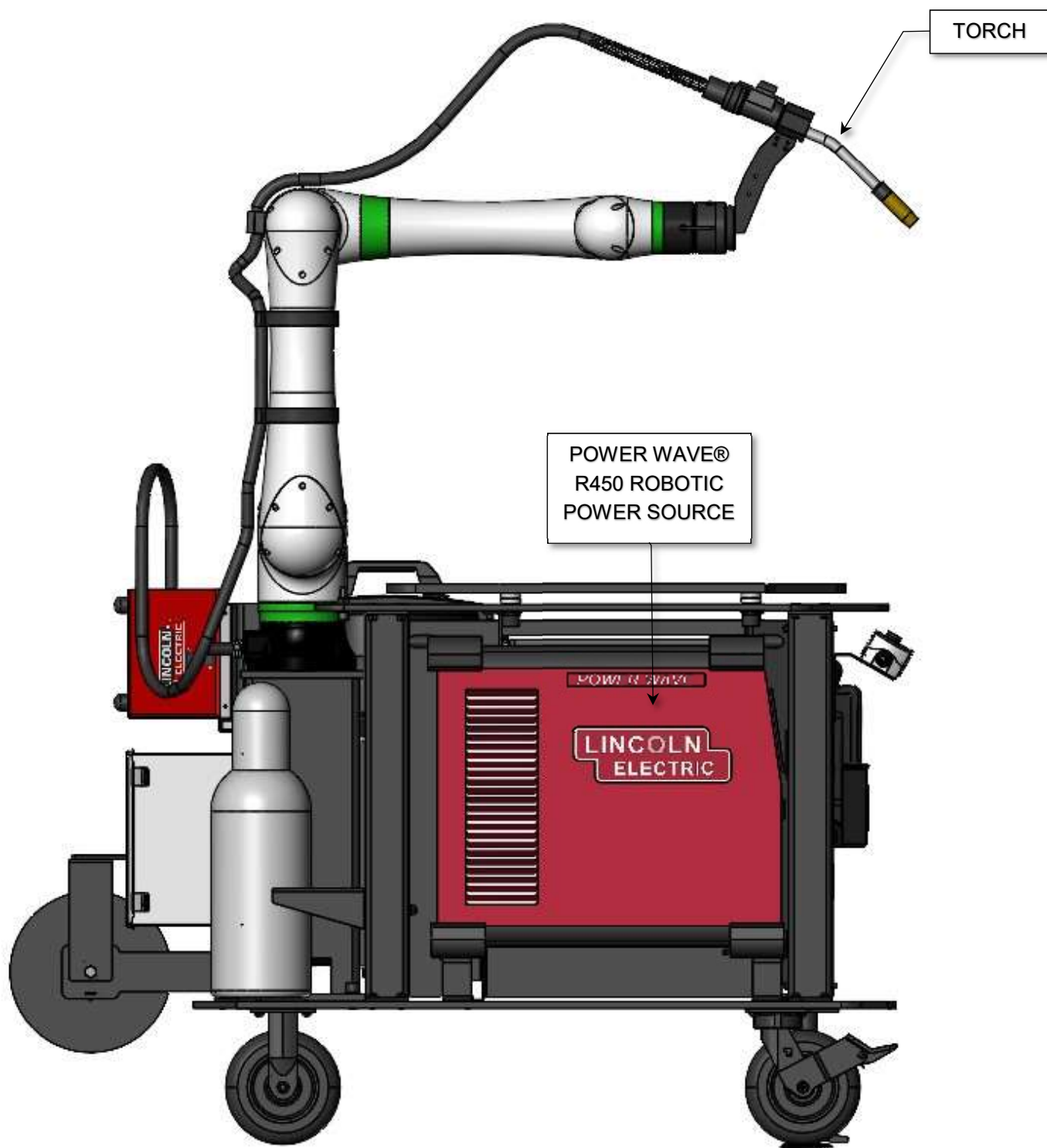

Installation and Setup

Unloading/Handling:

Care should be taken when unloading the equipment from the truck. Components may be mounted on the outside of the structures and therefore may be exposed and unprotected.

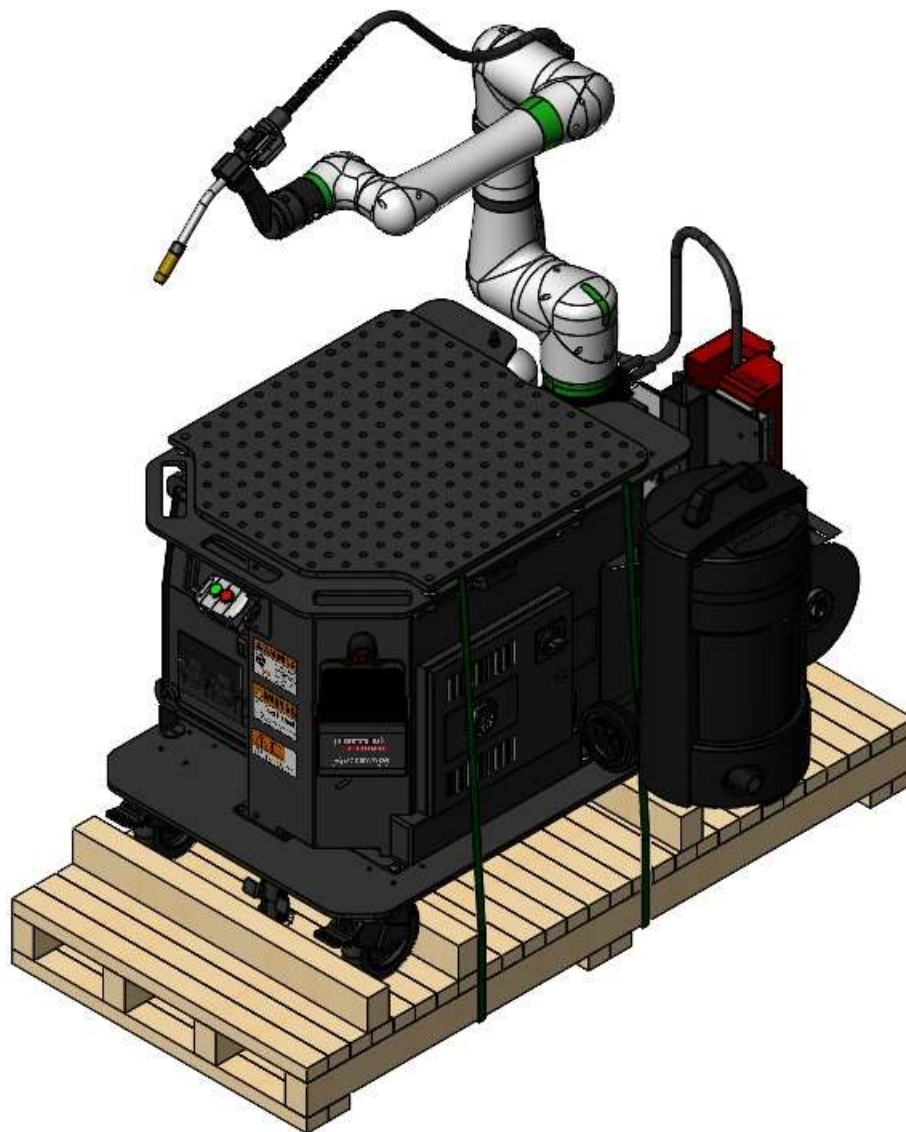

Inspection:

Before setting up the system, be sure to unpack and identify all the items. Ensure all items on the order have been received. Inspect the system and all components for damage.

Robot Operating Space

The entire blue bubble below is a collaborative area of CRX COBOT operation accordingly to part 5.11 of ANSI RIA R15.06-2012 (ISO10218-2) Robots and robotic devices. That means that safe and collaborative operation of the robot is not limited to the tabletop of the cart, but can be extended to any other part within the robot and the end effector (torch) reach area. The end user, at this point, is solely responsible for electrical and welding bonding of the external to the cart structures. To ensure safe and reliable operation, it is the responsibility of the end-user to follow all the assembly instructions and to train all operators, maintenance personnel, and all other employees involved with the system. All respective personnel shall study, based on their respective duties, the "RISK ASSESSMENT" document at the end of this manual. The risk assessment should consider, and operators should have a heightened awareness of, objects and individuals located within the Robot Reach Area during System set-up and operation. All individuals, including the operator, should be outside the RIA Operating Space while the robot is moving in AUTO mode. Welding should only occur within the RIA Operating Space.

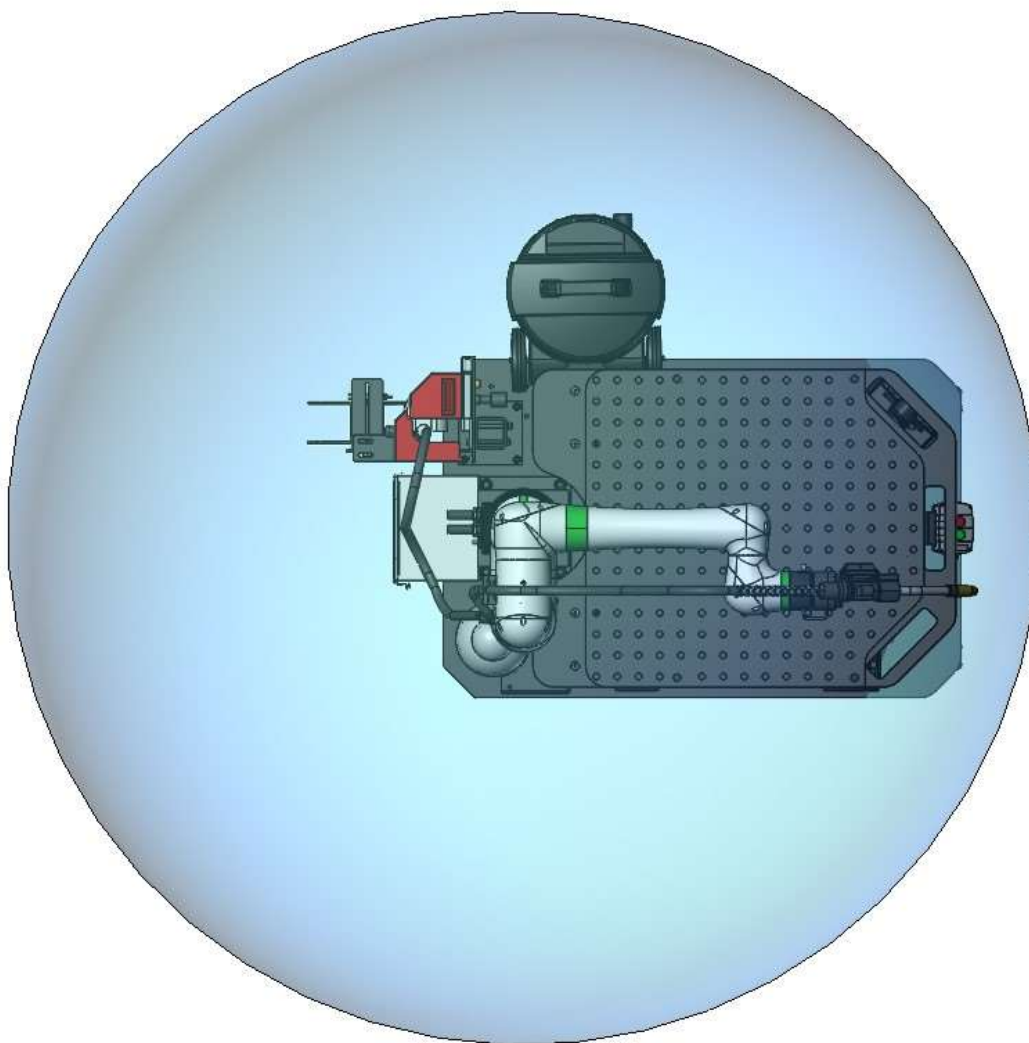

Power-up procedure and status indicator

At power up, the indicating light on top of robot J2 joint is red and the user is asked to confirm the payload by verifying the conditions and answering a few questions on the tablet's popup screens:

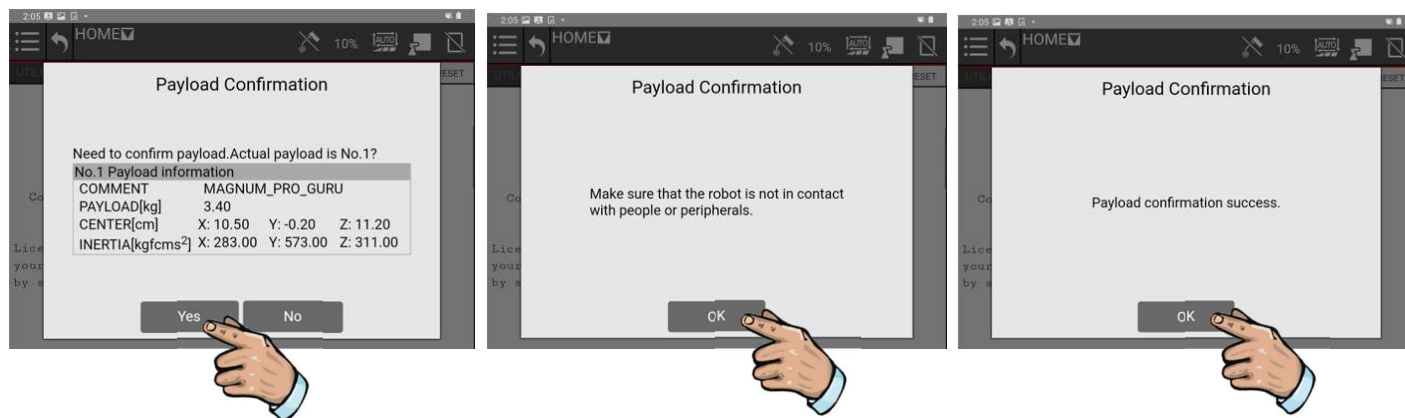

The indicating light is still red at this point, but the robot now is ready for manual or auto modes of operation. Touching the AUTO/MANUAL icon toggles the mode and touching the RESET button permitting robot moves. The indicating light turns from red to green:

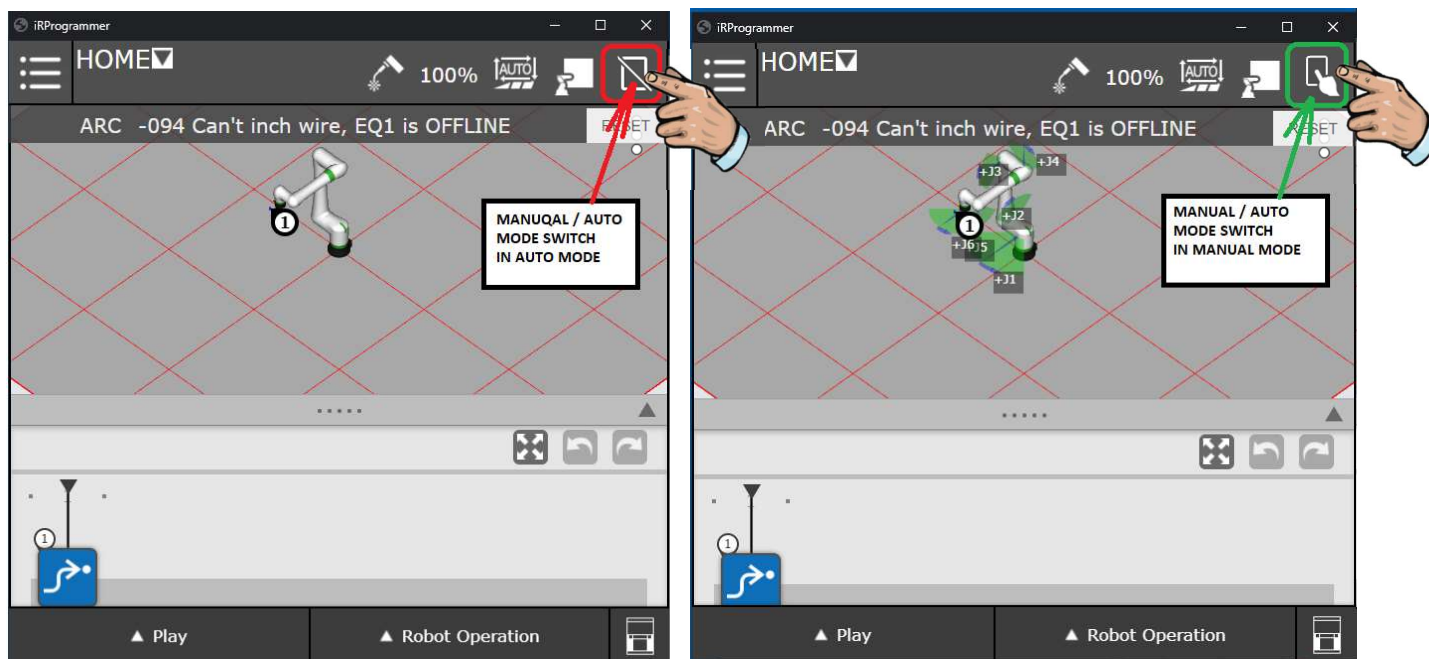

Smart Torch Features

Smart Torch feature 1 – torch-mounted enabling switch:

1. Press and hold this 3-position enabling switch half way, the green light on the robot base starts blinking and the robot can be freely moved by hand
2. Release the switch, the green light on the robot base becomes solid, the robot stops and no further movements by hand allowed
3. Pressing the switch all the way in (panic mode) stops the robot and no further movements by hand allowed; the switch now has to be released all the way back up and pressed half-way again in order to re-initiate movements

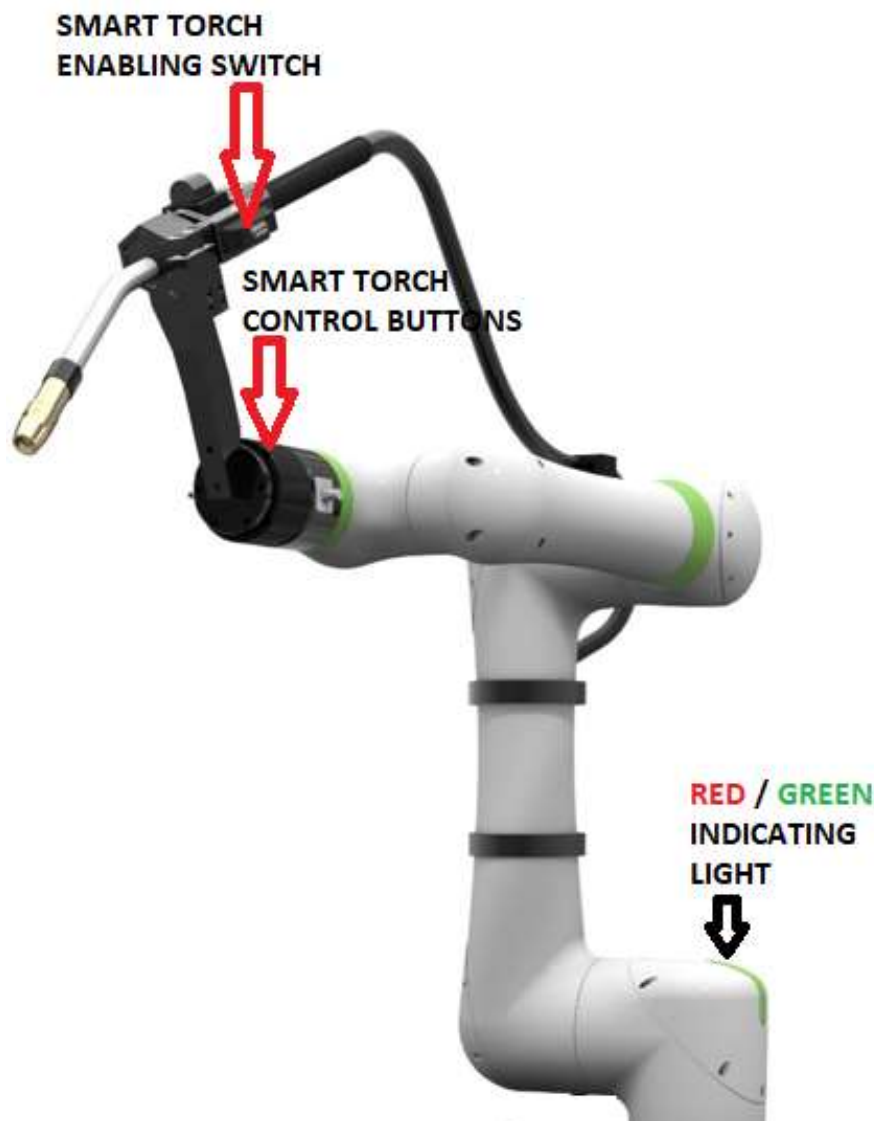

Smart Torch feature 2 – torch-mounted program control push buttons:

Left Smart Button “A”:

1. Move the robot to the starting point and briefly press the button – robot position point is recorded
2. Move the robot to the weld start position, press and hold the button for three seconds – welding ARC START is recorded and the button illuminates GREEN
3. Move the robot to the weld end position, press and hold the button for three seconds – welding ARC STOP is recorded and the button GREEN light turns OFF
4. Move the robot to an escape position and briefly press the button – robot position point is recorded

Right Smart Button “B”:

1. Not pressed – robot is in free mode and can be moved by hand freely in any direction and orientation
2. Pressed once – robot is in translation mode – only linear XYZ moves allowed
3. Pressed once again – robot is in rotation mode – no XYZ moves allowed, only rotation around TCP
4. Pressed once again – robot is back to a free mode and can be moved by hand freely in any direction and orientation

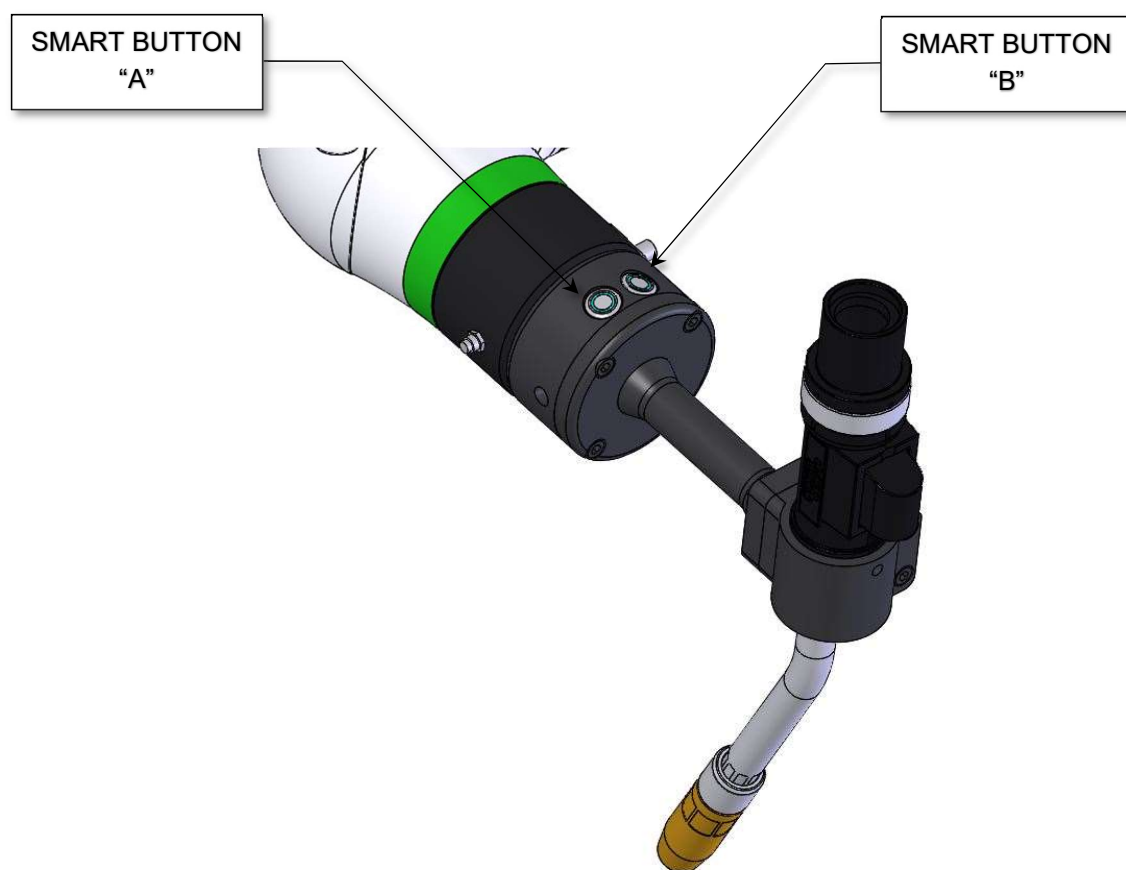

Home robot position and TP program

HOME program provided as part of core software is a one-line sequence that is the main reference position (HOME) for all six axes of the robotic arm. This point will clear the robot off the working zone and any other obstruction within the system. It is strongly recommended that all user created programs end with the HOME program called. This will return the robot to a known safe point when finished. To run the robot to its HOME position at any time, make sure HOME program is selected (shown in the upper left corner of the tablet) switch it to AUTO mode (1), touch Play field (2) to call Run / Stop operation and touch Run button (3) – the robot will move to its HOME position.

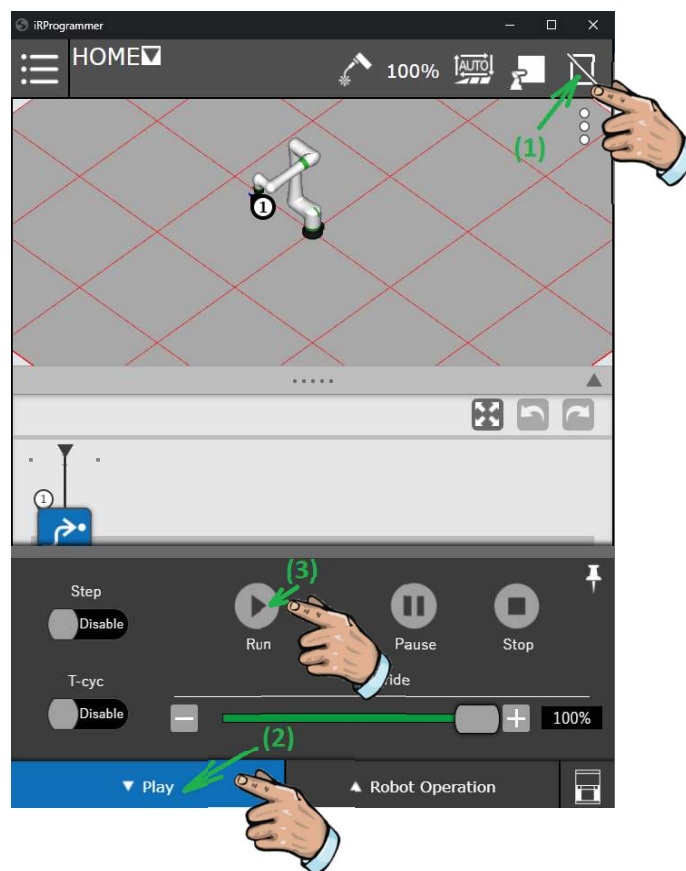
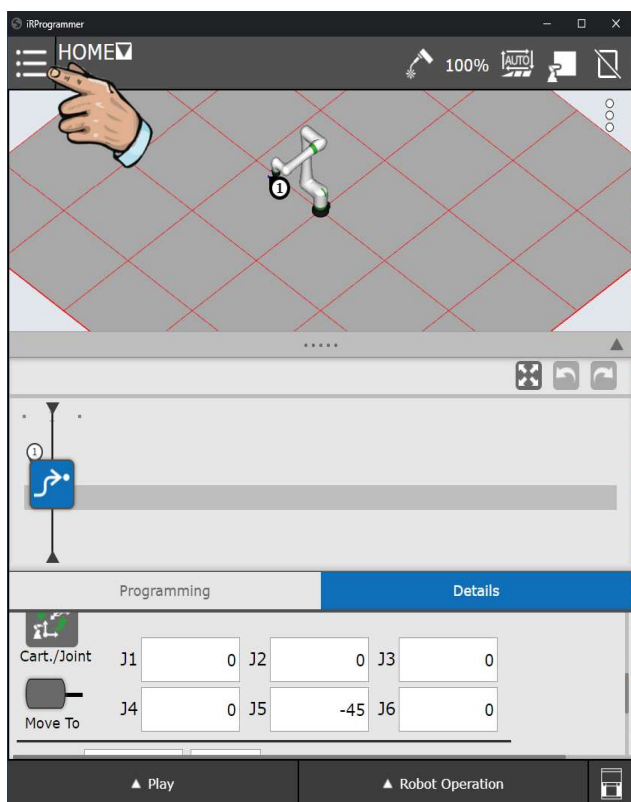

This (or any other program) will run by pressing green START button on the external push button station.

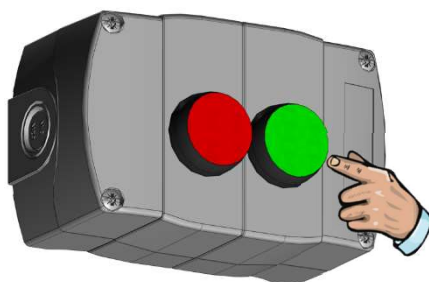



System Operation

Program Mode:

This mode is used to program parts and “touch-up” existing programs as well as for various maintenance procedures. Review sample programs from the robot manufacturer for programming examples and proper sequence of operations. Prior to programming, verify that all parts are properly mounted and secured.

Sequence of Program Cycle:

Turn the MODE switch to manual: 

Touch the RESET button: 

To create a new program, touch the pull-down menu, touch Select Program, then touch  New icon, enter program name and touch OK button. AAA program has been created and automatically selected for an immediate programming and usage:

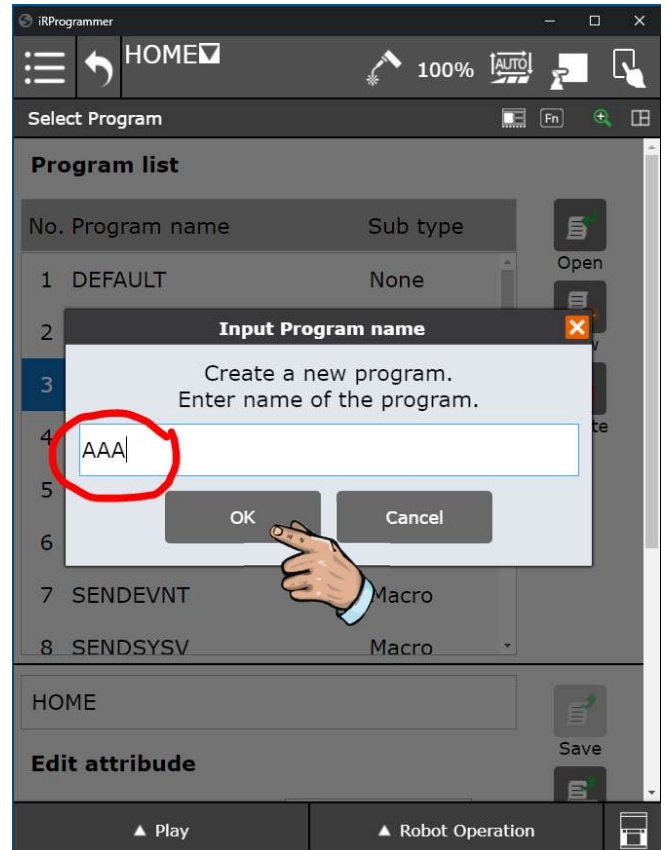
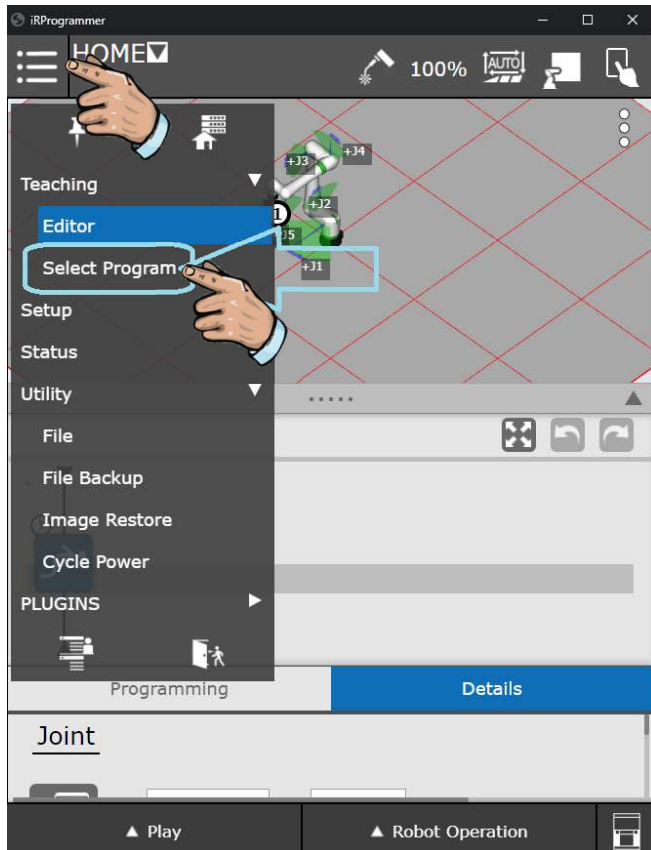

This screen shows the program's time line and instructions in the form of an icon string. Touch ArcTool selection and drag the Arc Handle Teaching icon up onto the time line. Touch the check box to begin manually teaching program points.

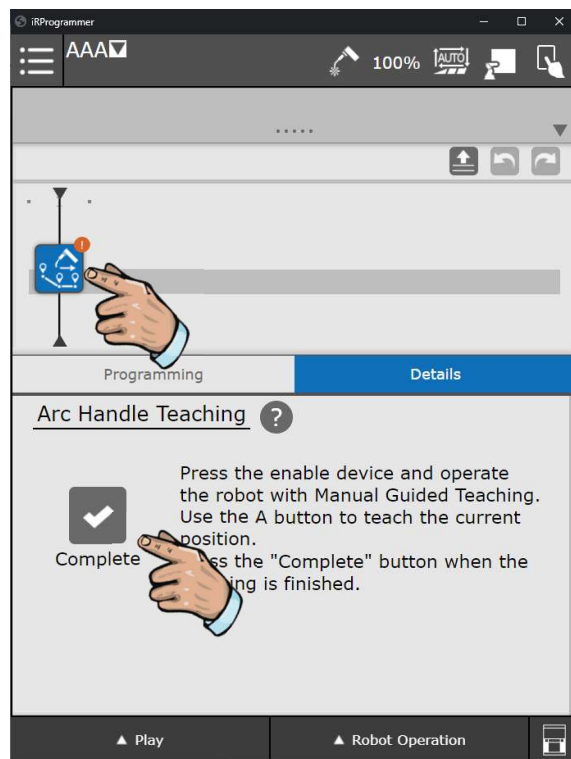
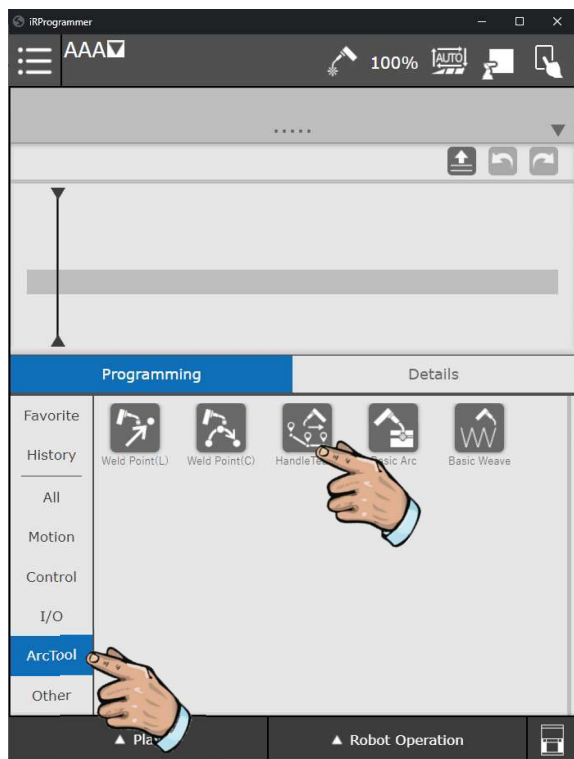

Press the 3-way enabling switch located on the smart torch to its middle position, manually move the robot to its first point, and briefly press left "A" button on the base of the torch. A move icon will appear on the program's time line. Continue this process until you are ready to teach your Weld Start point:

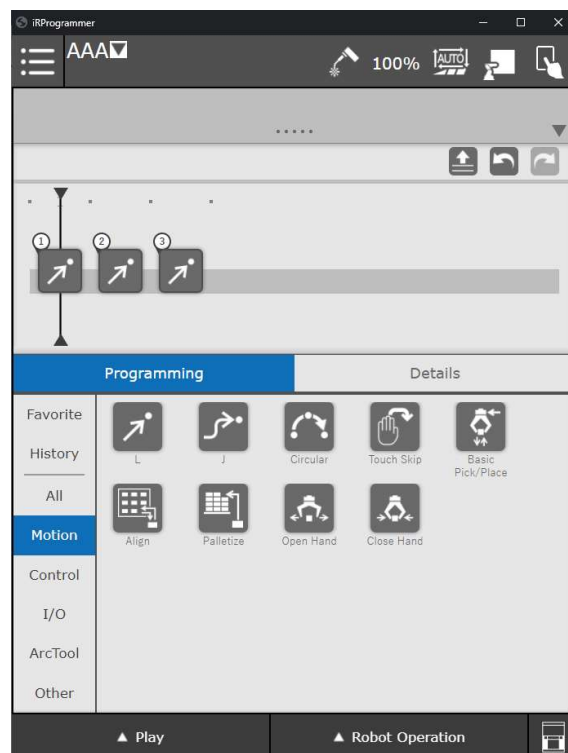
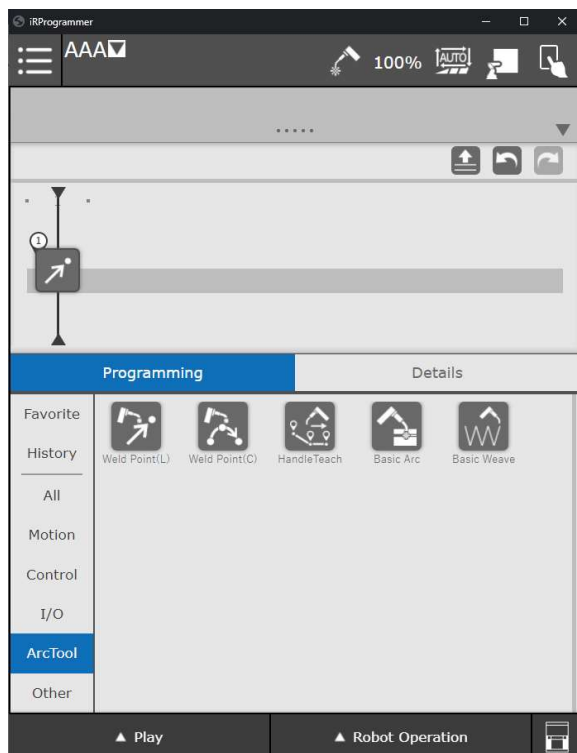

When robot moved to the Weld Start point, press and hold the “A” button on the Smart Torch for 3 seconds. A green light will surround the A button indicating that Weld Point and Weld Start are being recorded. A Weld Start icon will appear on the program’s time line:

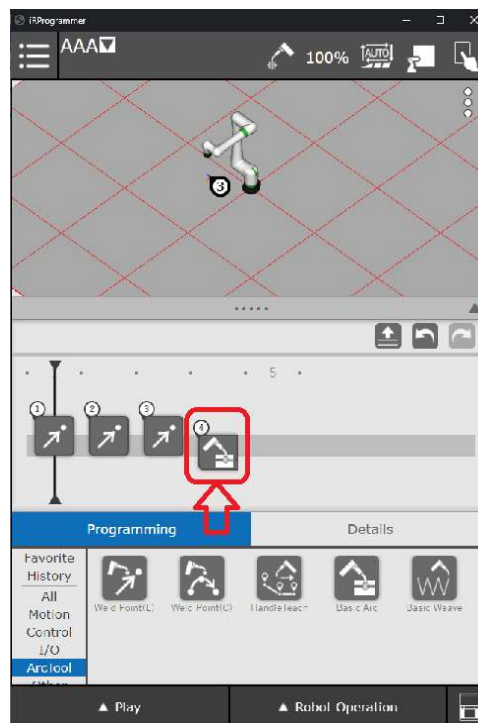

Now move the robot to the Weld End point, press and hold the “A” button on the Smart Torch for 3 seconds. A green light surrounding the “A” button turns off, indicating that the Weld End point is being recorded. A Weld End icon will appear on the program’s time line. Move the robot to its Escape Point and other desired points briefly pressing the “A” button to record those points:

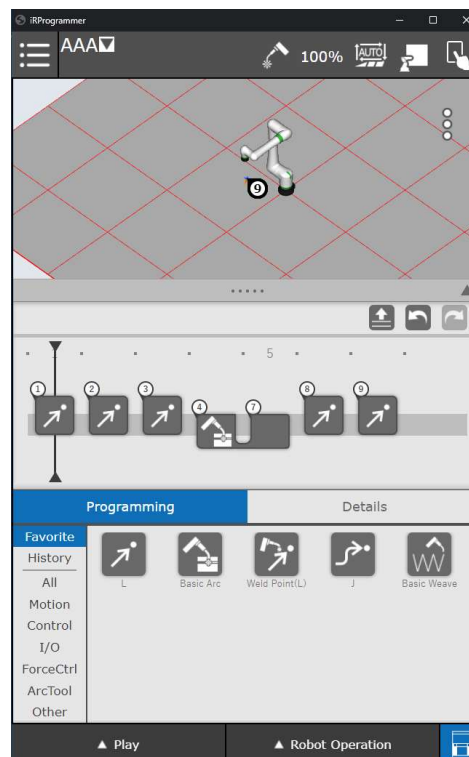
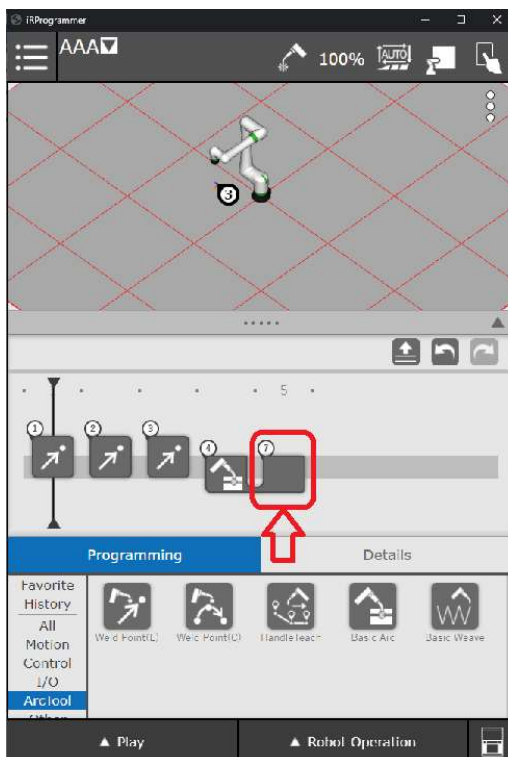

To automatically run programs at full speed – use Code **OVERRIDE=100%**
To always end up programs at a known position – use Call **HOME** program

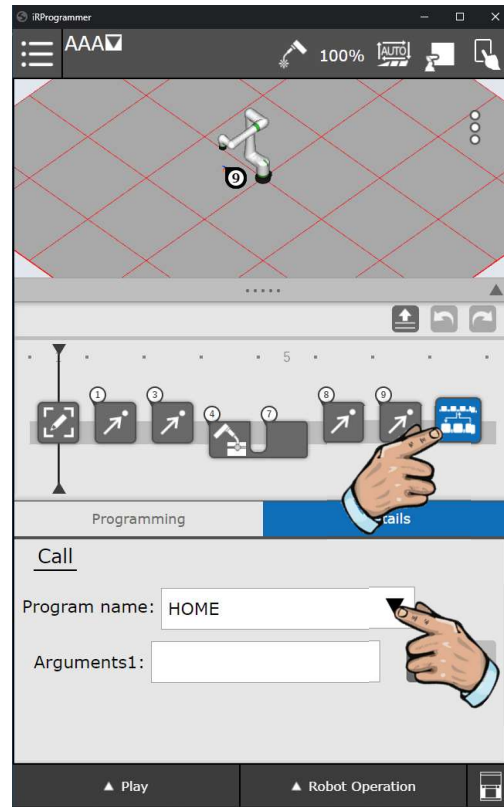
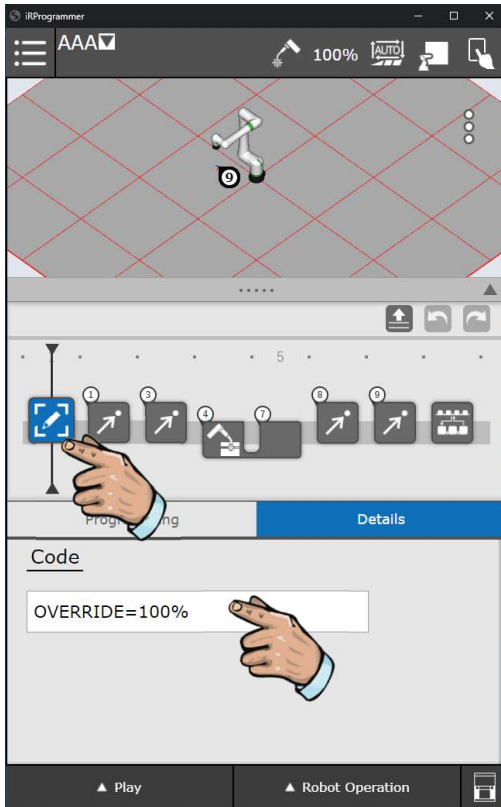

Touch the WELD icon in your new program and touch Details then; scroll down to enter desired weld parameters:

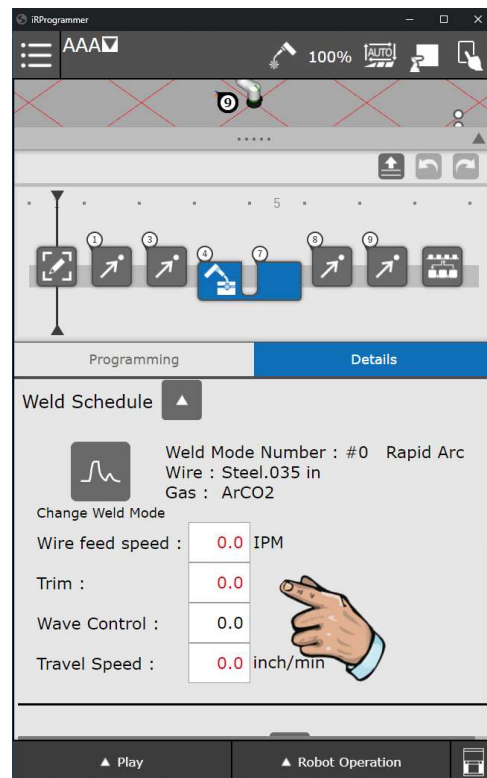
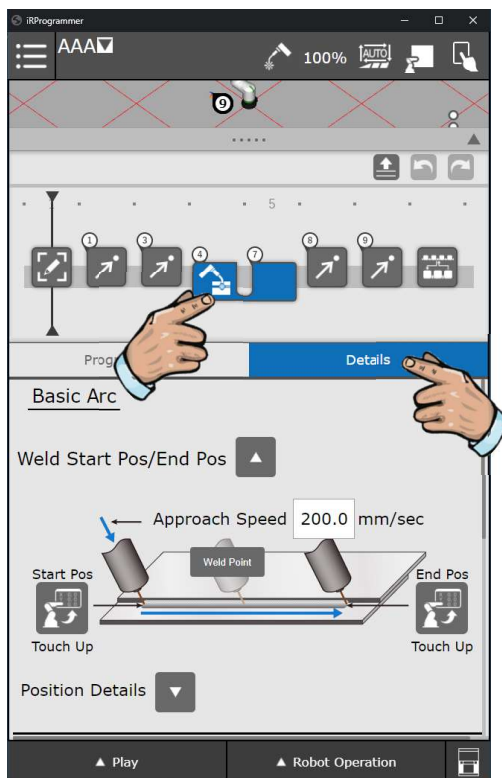

THE LINCOLN ELECTRIC COMPANY

Production Mode initiated from robot tablet pendant

WARNING - PRIOR TO OPERATION IN AUTO MODE, VERIFY:

1. **Robot is clear of obstructions and all foreign objects are removed;**
2. **Operators have proper PPE and are not positioned between the welds and the fume extraction or other ventilation equipment**

This mode is used for production and automatic operation of the system. After all parts have been programmed and welds examined to meet specifications, this welding system can be used for continuous operation.

Sequence of Auto Cycle:

1. Turn Teach Pendant **OFF**
2. Press **RESET** button
3. Touch **WELD** symbol and enable weld

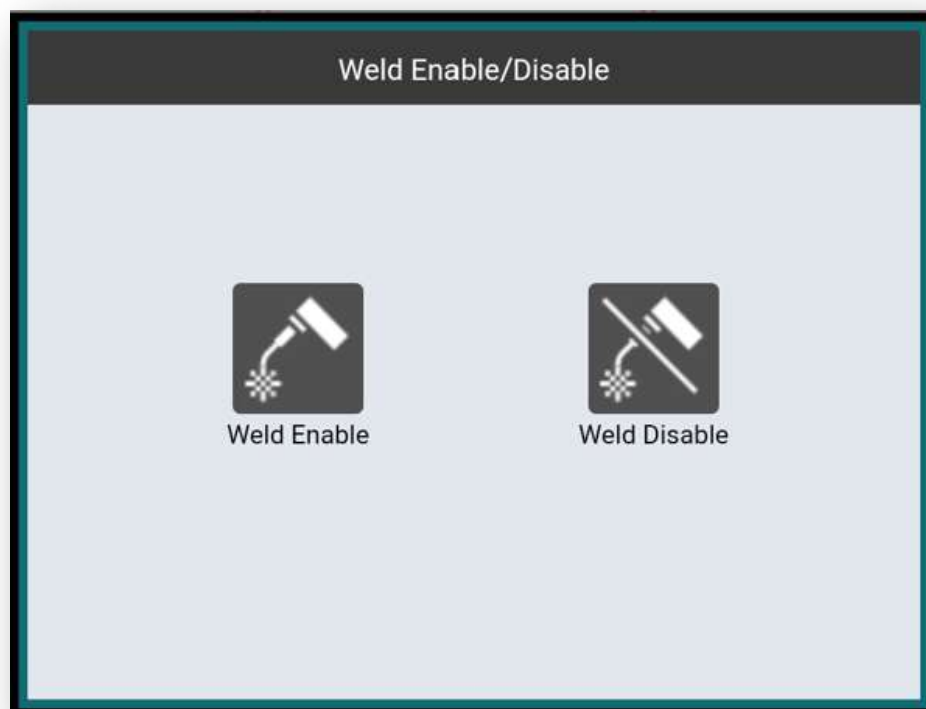

4. Touch **Play (1)**, move speed slide to 100% **(2)** and press **RUN** button **(3)**

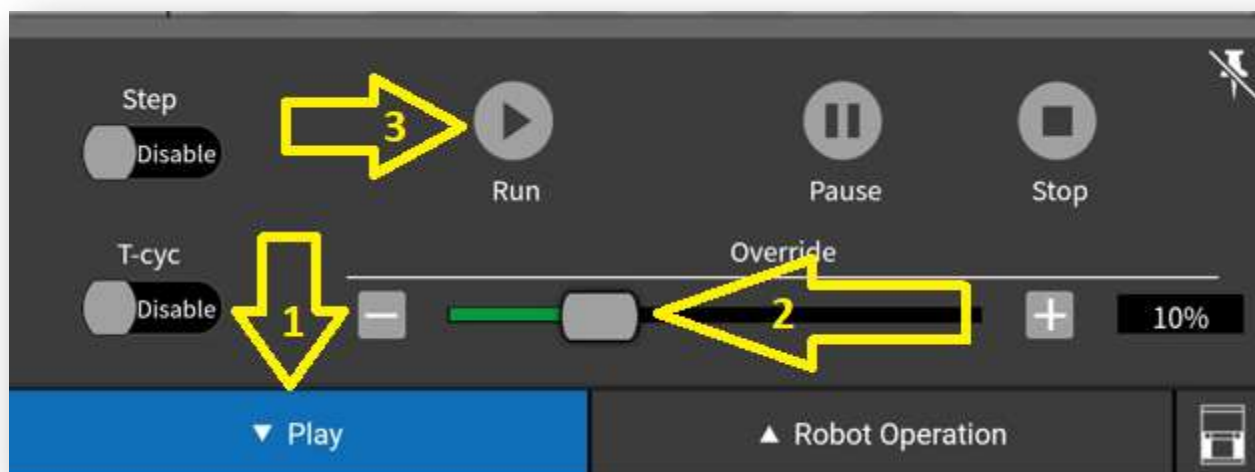

5. Robot will run the user selected program. The program can be interrupted at any time by touching **PAUSE** button or stopping the robot movement simply by touching it.
6. At the end of a production program, the robot goes back to its **HOME** position.

NOTE: If the program is interrupted for any reason, clear the fault condition, touch RESET and then touch RUN in order to restart

Production Mode with START-HOLD-RESET push button console

WARNING - PRIOR TO OPERATION IN AUTO MODE, VERIFY:

1. **Robot is clear of obstructions and all foreign objects are removed;**
2. **Operators have proper PPE and are not positioned between the welds and the fume extraction or other ventilation equipment**

This mode is used for production and automatic operation of the system. After all parts have been programmed and welds examined to meet specifications, this welding system can be used for continuous operation.

Sequence of Auto Cycle:

1. Turn Teach Pendant **OFF**
2. Touch **RESET** on tablet or press red **RESET** push button
3. Touch **WELD** symbol and enable weld

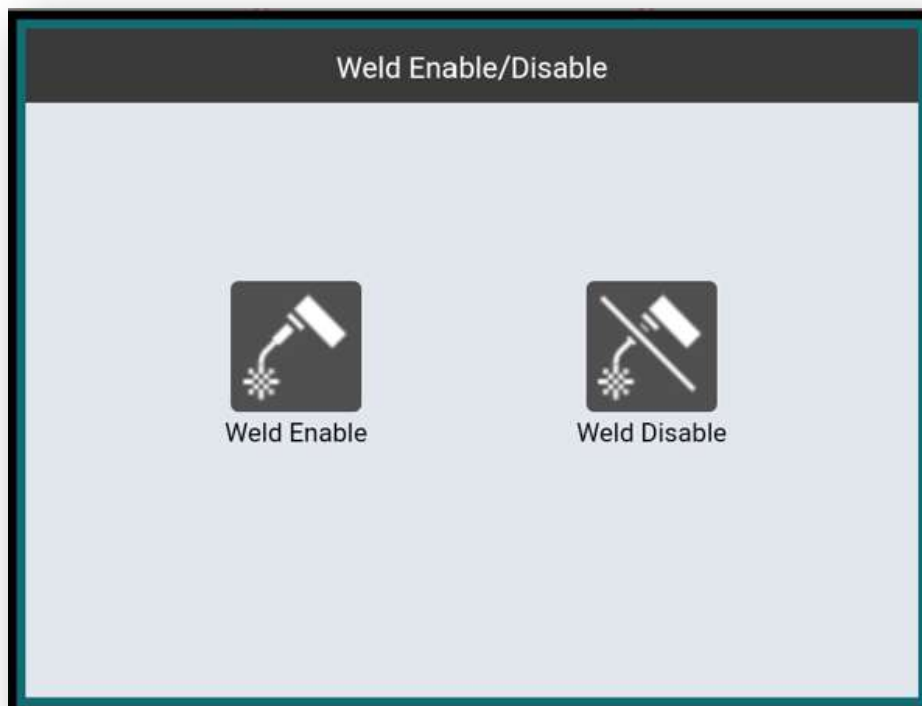

4. Press red **RESET** button if illuminated and then press green **START** button – it will lit indicating that program is running and the robot will run the user selected program:

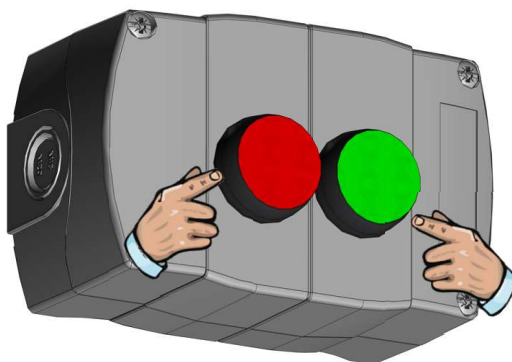

5. At the end of a production program, the robot goes back to its **HOME** position.

NOTE-1: *The program can be paused at any time by pressing red button. Green button light will turn off. Pressing the green button while program is paused will immediately resume the program from the point it was halted at and the green button light will lit.*

NOTE-2: *If the program is interrupted for any reason, clear the fault condition, press red RESET button (red light turns OFF) and then press green RUN button in order to restart (green light turns ON).*

Safety Features

CRX COBOT CART is equipped with several safety features to help protect the operator from injury caused by the robot motion. The following components are used in the safety scheme of this system:

- Power and Force Limiting robot constructed in accordance with ISO/TS 15066:2016 Robots and robotic devices — Collaborative robots.
- 3-position safety rated enabling switch located on smart torch.
- 3-position safety rated enabling switch located on the tablet holder.
- Tablet holder integrated E-STOP button.

Fault Recovery

If a fault occurs during automatic operation, the system will stop, the indicating light in the base of the robot will turn red and the tablet will indicate fault conditions.

To recover from fault:

1. First, determine and correct the fault condition(s). The tablet displays an error message, which defines the cause of the fault.
2. Touch RESET button on tablet or press red illuminated RESET button on the remote push button console. If all faults have been cleared, the system will be ready to resume operation. Press the Run button on tablet or press green START button on the remote push button console to resume operation.

Troubleshooting

To access the Alarm screen, touch the pull-down menu and select “Status” – “Alarm Status”. “Active” tab will show active alarms [if any] in an order they occurred, History tab will show alarm history:

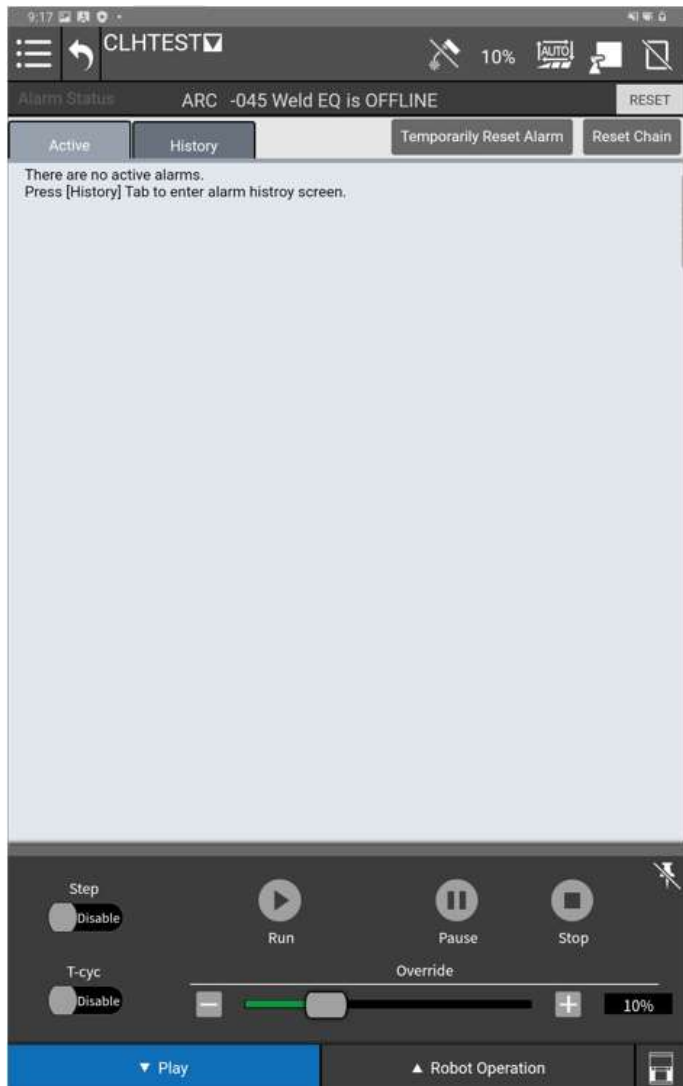

Refer to manual B-83284EN-1 “Fanuc Robot Series R-30iB Mini Plus Controller Operator’s Manual (Alarm Code List)” for detailed alarm definitions and remedies.

Maintenance

This section provides general maintenance guidelines for the system. It does not provide maintenance guidelines for the system's individual components. Be sure to follow the appropriate maintenance procedures for the different components of the system (robot, welding power source, etc.).

Refer to manual B-84175EN/0x "FANUC R-30iB Mini Plus Controller Maintenance Manual" for detailed information on robot controller maintenance.

Refer to manual B-84194EN/0x "FANUC Robot CRX-10iA, CRX-10iA/L Mechanical Unit Operator's Manual" for robot arm maintenance.

WARNING: FAILURE TO PROPERLY CONDUCT PREVENTATIVE MAINTENANCE CAN LEAD TO MACHINE DAMAGE AND/OR PREMATURE FAILURE OF COMPONENTS AND MAY CREATE HAZARDS THAT COULD RESULT IN PROPERTY DAMAGE OR INJURY.

Recommended Maintenance Schedule:

Daily:

- Check equipment and remove any object not required for operation.
- Check any exposed cables for defect.
- Check for loose connections or improper operation of equipment functions.
- Check for oil seepage on the sealed part of each joint.
- Check for abnormal noises or vibration.
- Check welding torch for tip, nozzle, or cable wear.

Weekly:

- Verify proper operation of all safety components.
- Test peripheral devices for proper operation.
- Clean robot, power source, operating equipment, and all peripheral devices.

Monthly:

- Inspect welding torch body and components.
- Inspect teach pendant cable.
- Check that the cooling fan rotating quietly; if the fan has dust buildup, clean the fan.
- Clean wire feeder assembly.

Every 4 Years:

- Change CPU Lithium battery on front panel of main control PC Board.

When BZAL alarm appears, replace the backup batteries following these steps:

THE LINCOLN ELECTRIC COMPANY

1. Keep the power on.
2. Press the ESTOP button on tablet holder fixture.
3. Remove the bolts and the J2 arm root side cover.
4. Unplug the cable connector of the batteries.
5. Remove the bolt and the cover plate of the battery.
6. Take out the batteries (2 pcs) from the battery case.
7. Install fresh batteries (2 pcs) in place.
8. Reinstall J2 cover and tighten the bolts.

Note – the J2 cover gasket is reusable.

Warning – replacing the batteries with power turned off will cause current position data of all the axes to be lost and, therefore, Zero Position mastering procedure will have to be performed (refer to manual B-84194EN/0x “FANUC Robot CRX-10iA, CRX-10iA/L Mechanical Unit Operator’s Manual”).

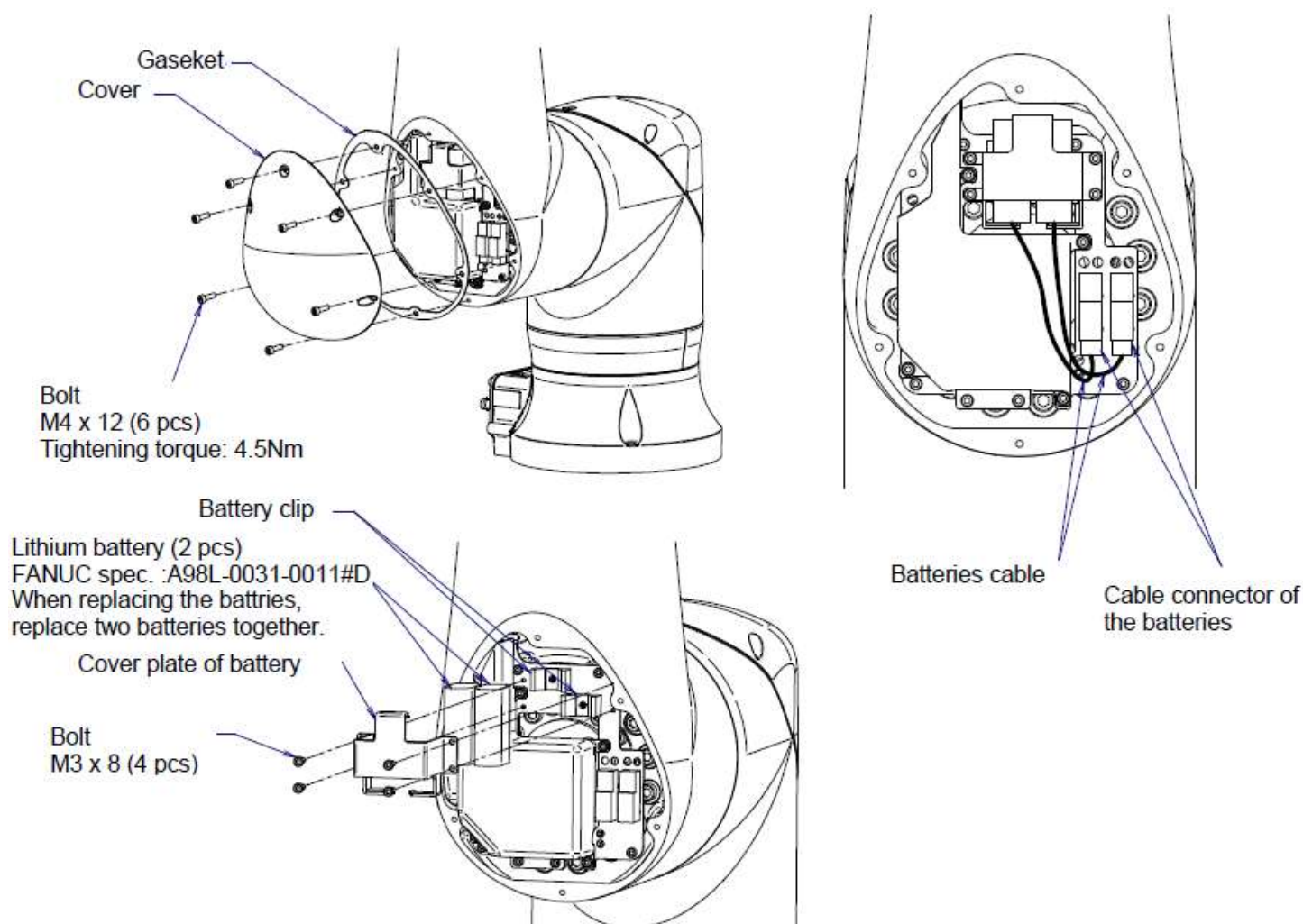

Parts List

DESCRIPTION	P.N.	Q-TY	COMMENTS
S18453-3 GAS LINE ASBLY-25FT	S18453-3/12-15	1	
WIRE DRIVE CABLE (12FT)	K2709-12	1	
AUTODRIVE 4R100 WIRE FEEDER	K3560-1	1	
DRIVE ROLL KIT (.045, 4 ROLL)	KP1505-045S	1	
CONTACT TIP 550, .045	KP2745-045	10	
DRIVE ROLL KIT (.035, 4 ROLL)	KP1505-035S	1	
CONTACT TIP 550, .035	KP2745-035	10	
A/C ROBOTIC TORCH	K2647-11	1	
LINER, 035-045,10/12/15' GUN(45-3545-15)	KP45-3545-15	1	
300 X 460 POLY CONDUIT 25FT	AD1329-453	1	
ADAPTER INSULATOR CRX TORCH	A3040021	1	
22D TORCH MOUNTING ARM	A3045996	1	
CPU BATTERY	S22320-16	1	
ENCODER BATTERY	S22317-1034	2	
TABLET TEACH PENDANT	AD1253-838	1	
CRX TP CABLE 10M	A2025593	1	
R30IB MINI+ SPARE FUSE KIT	A2025507	1	
CRX START STOP RESET PB STATION W/CORD	A5003611	1	
ENABLING DEVICE CRX, AC TORCH	A4015601	1	
HARNESS, CTRL BUTTONS CRX	A3048271	1	
CRX LOTO POWER DISTRIBUTION BOX	AD2498-5	1	* IF OPTION PURCHASED
SWIVEL CASTER	A2017371	2	
RIGID CASTER	A2017370	2	
LOCKING KICKSTAND	A2017372	1	
XTRACTOR UNIT	K3972-5	1	* IF OPTION PURCHASED
WIRE REEL KIT	AD2498-1	1	* IF OPTION PURCHASED

Optional Software and PAC processing

DESCRIPTION	P.N.	COMMENTS
THICK PLATE BUNDLE	A2020787-R877	Includes Touch Sensing and TAST with MP /RPM
PASSWORD PROTECTION	A2020787-J541	

Optional software packages offered as Product Authorization Code (PAC) and can be purchased and added at any time. In order to process PAC request, robot data has to be obtained following these steps - Touch MENU => NEXT => STATUS => TYPE => Version ID:

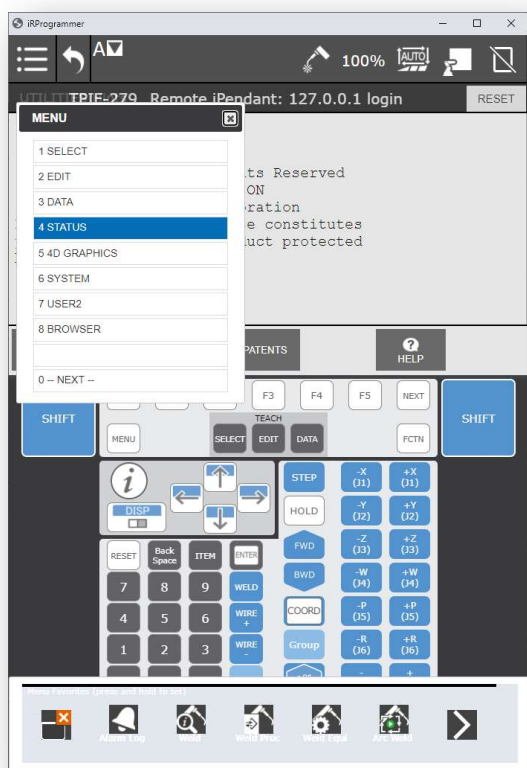

Record robot information (or take a picture) and send it to LE AUTO representative:

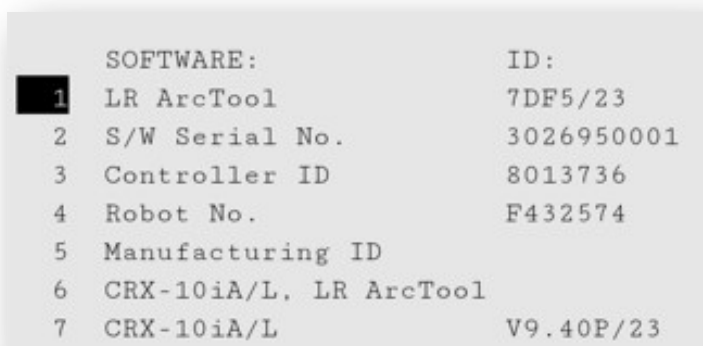

After receiving PAC number(s), insert the original USB software stick into USB port on the side of COBOT MINI controller:



Go to CONTROLLED START - touch FN button => NEXT => START MODE => CTRL:

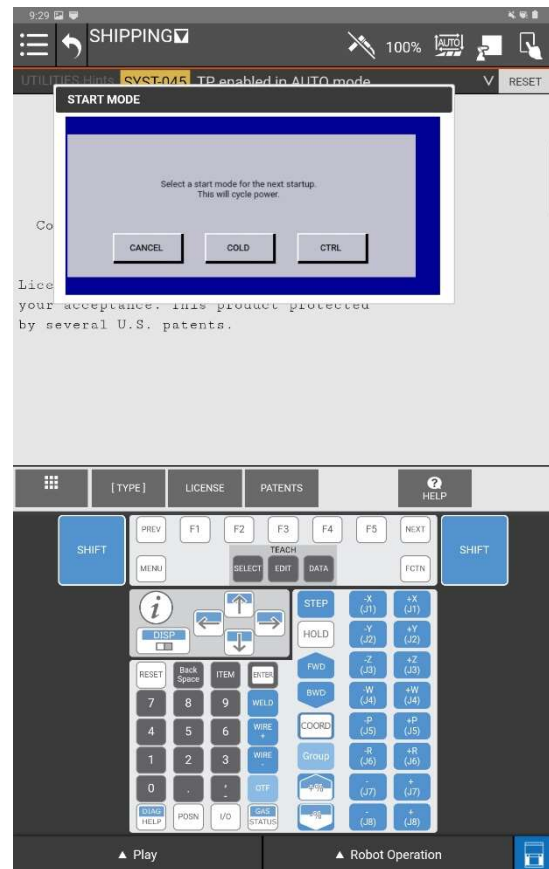
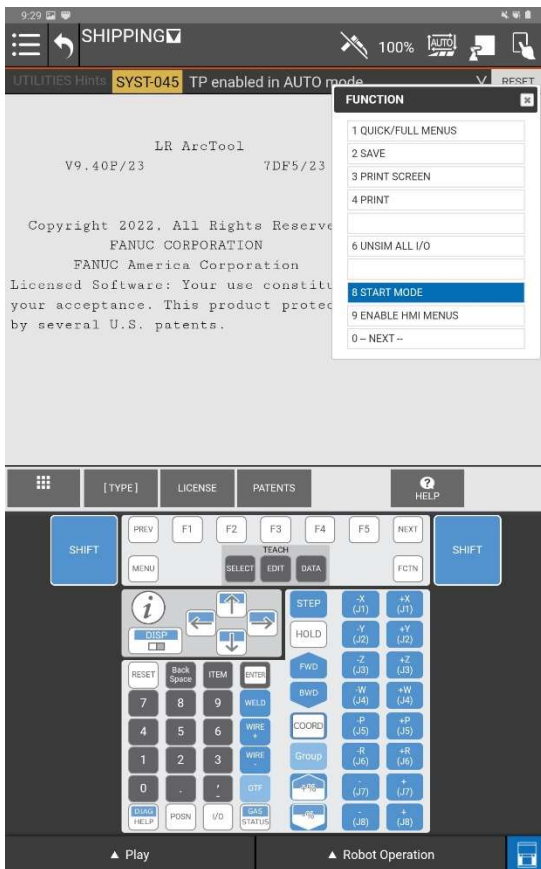

Wait for this message to pop up and turn power switch to Off position; wait 5 seconds and turn power switch back to ON position – wait for the robot controller to reconnect to the tablet:

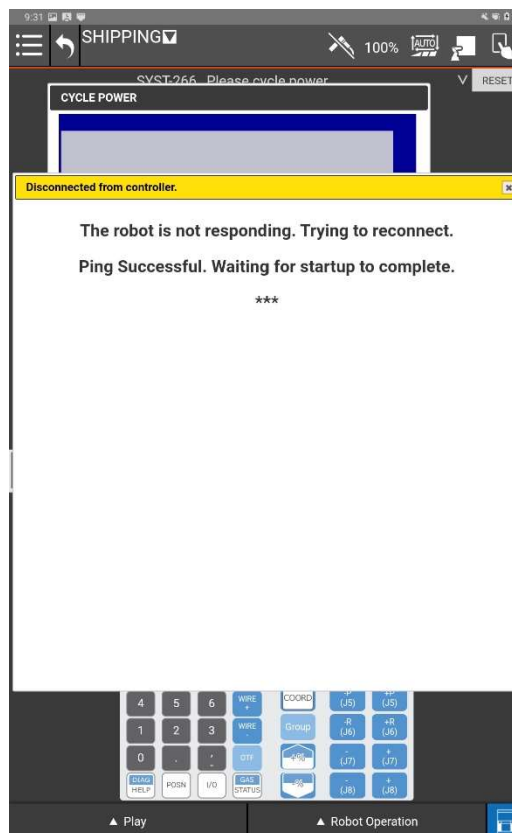
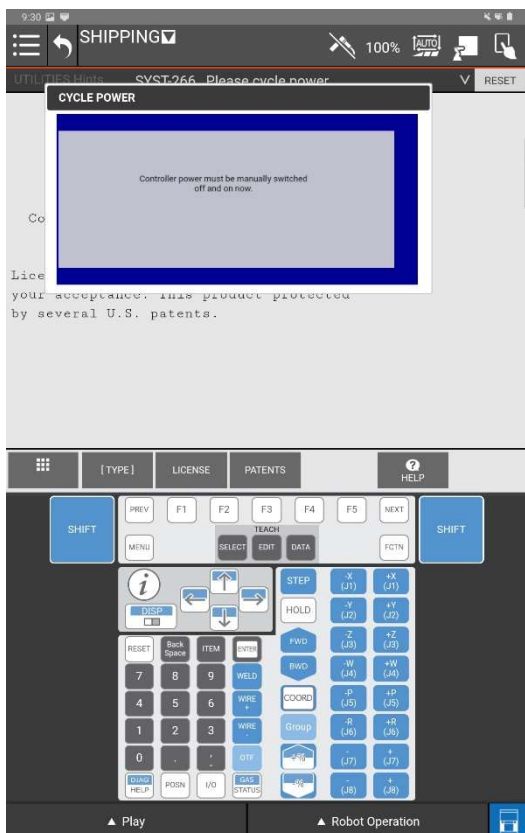

After startup completed, touch MENU => S/W INSTALL => Option / Robot Library:

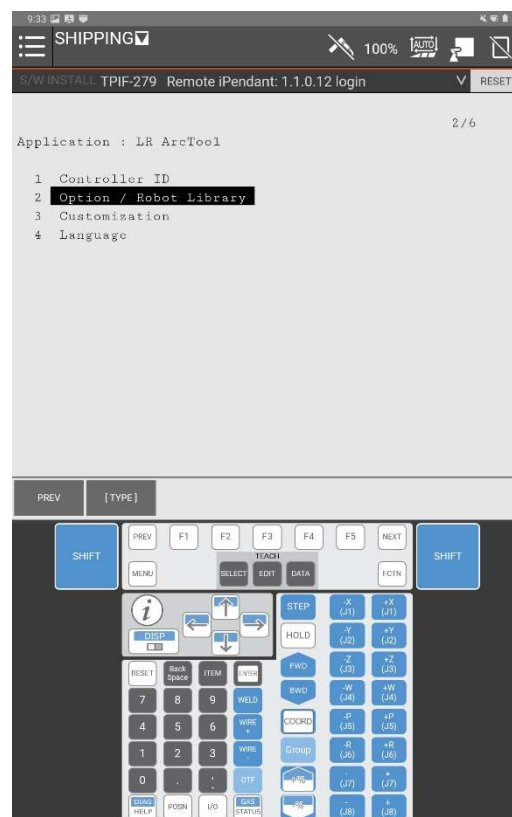

THE LINCOLN ELECTRIC COMPANY

Scroll down to USB(UD1) => CHOICE => USB(UD1) => DONE:

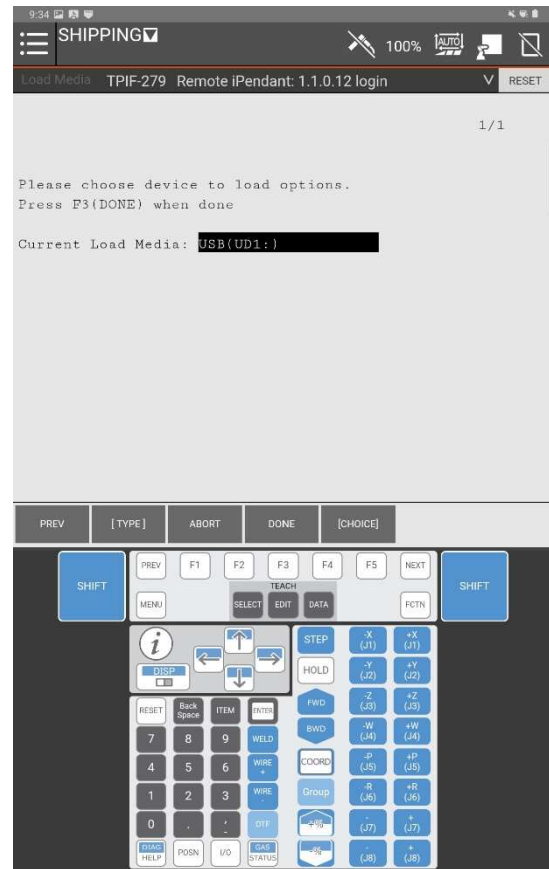
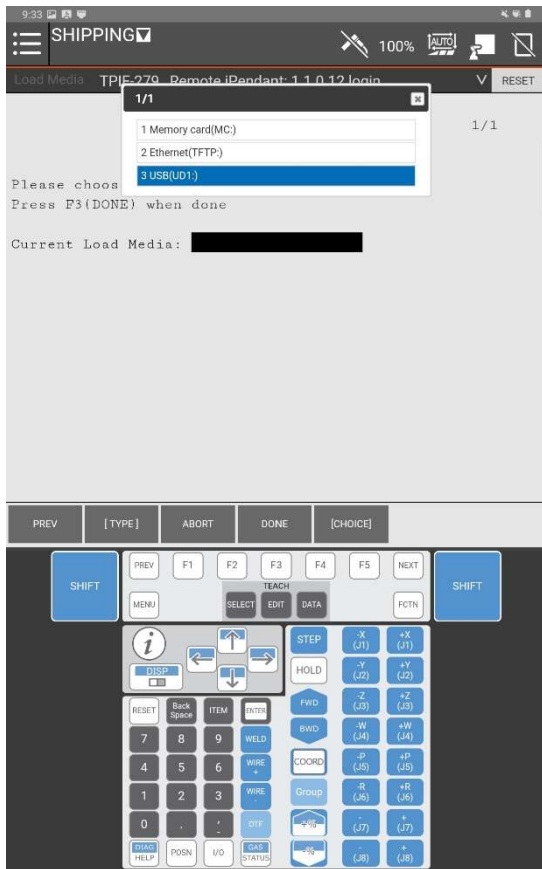

From the scroll-down menu on the left, select the option to install, type the PAC number and touch AUTH; wait for Option Status line to show Authorized:

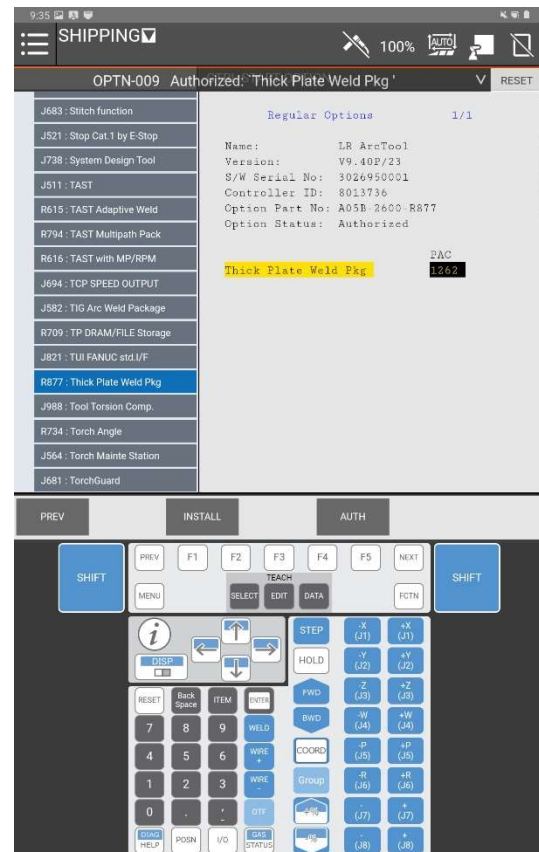
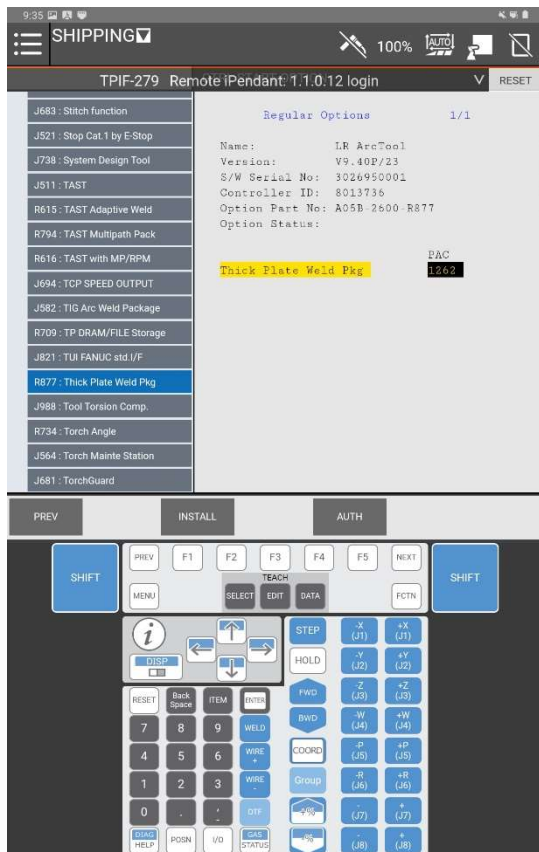

Touch **INSTALL** and wait for the Option Status line to show **Installed** (this might take a few minutes):

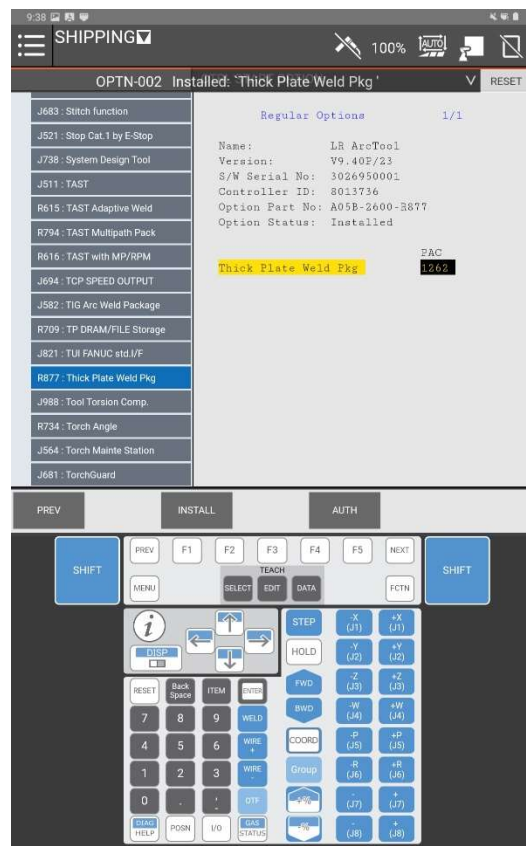
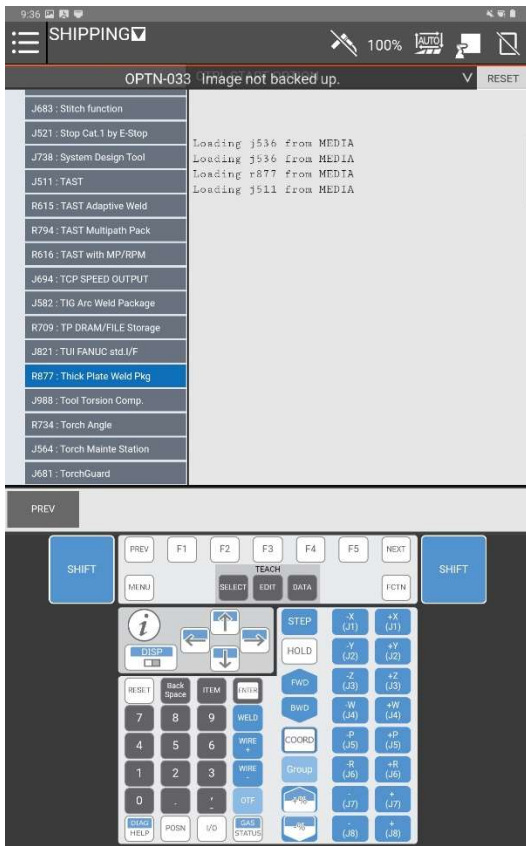

Repeat PAC installations for other SFTW packages (the PAC numbers will be different for each); when done, touch **FN => START (COLD)** – robot controller will go to its normal run mode with all new SAFTW packages installed and functional:

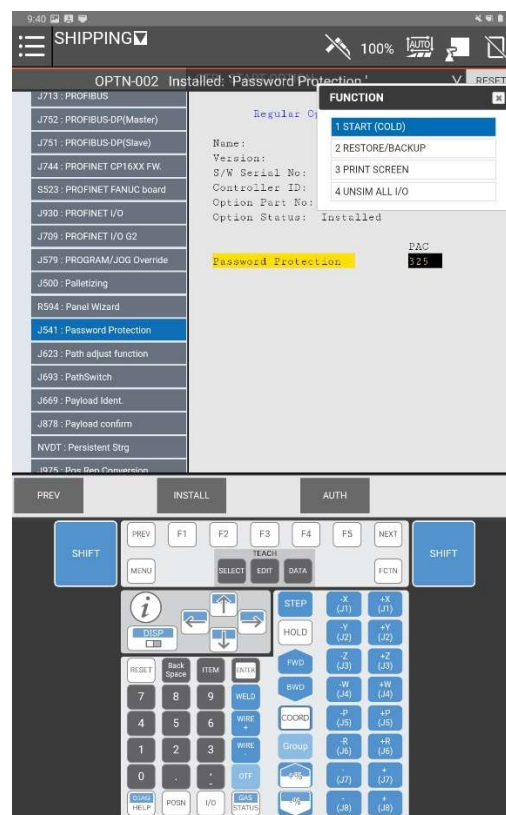
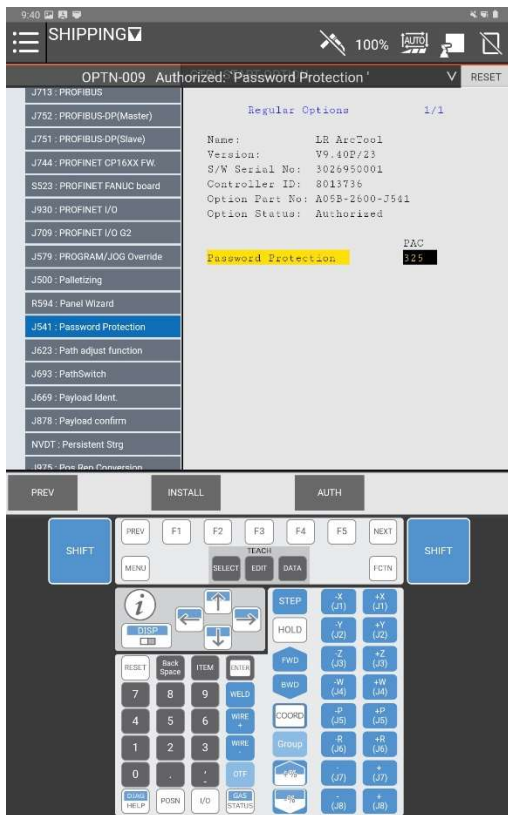

THE LINCOLN ELECTRIC COMPANY

Optional Equipment

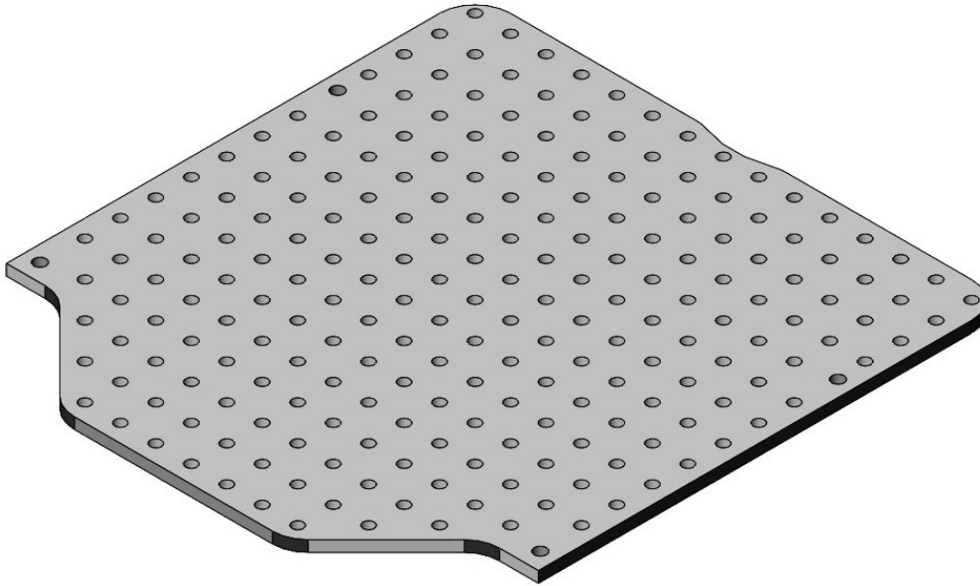

TOOLING TABLE TOP		
ITEM NUMBER	PART NUMBER	DESCRIPTION
1	AD2498-2	MOUNTED ON TOP SURFACE OF CART



X-TRACTOR® MINI		
ITEM NUMBER	PART NUMBER	DESCRIPTION
1	K3972-5	MOUNTED ON LEFT SIDE OF CART

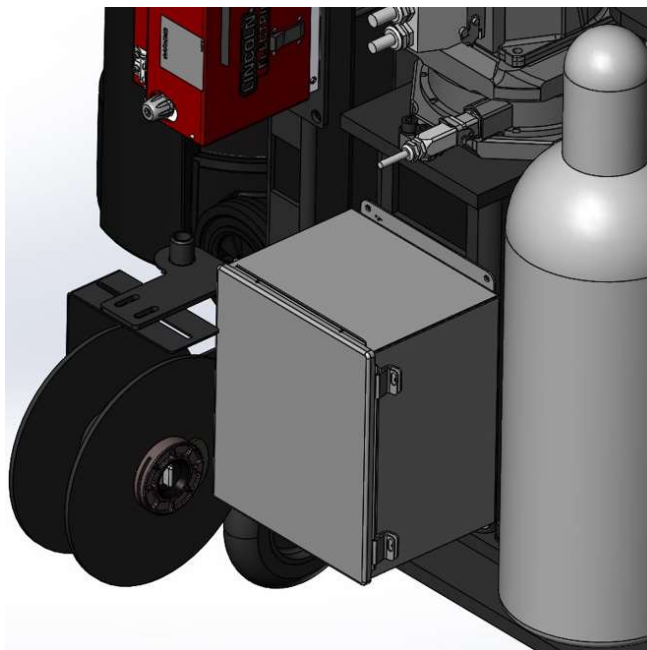
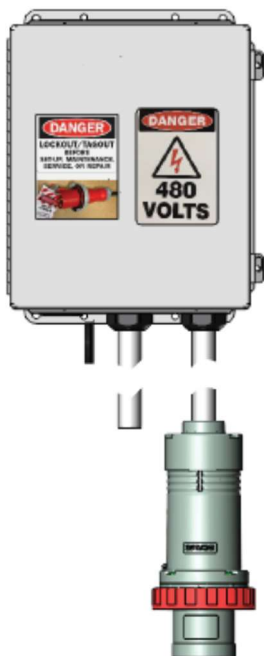

CRX POWER DISCONNECT BOX		
ITEM NUMBER	PART NUMBER	DESCRIPTION
1	AD2498-5	MOUNTED ON BACK OF CART

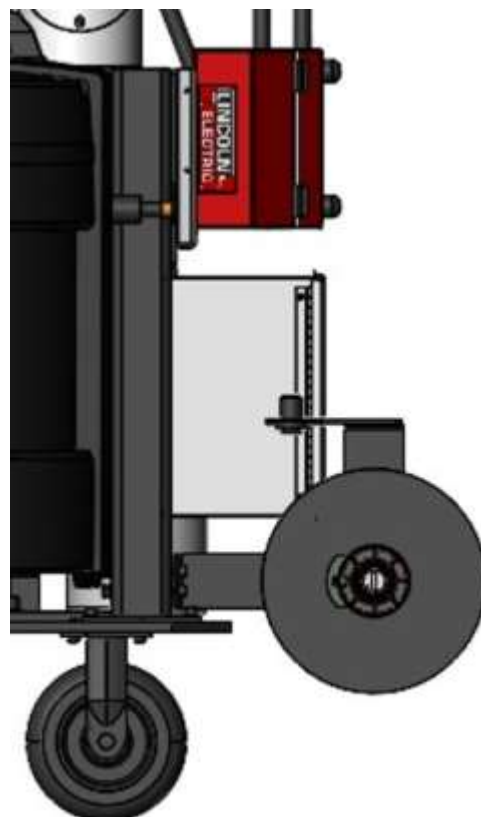

WIRE REEL KIT		
ITEM NUMBER	PART NUMBER	DESCRIPTION
1	AD2498-1	MOUNTED ON BACK OF CART

Customer Assistance Policy

The business of Lincoln Electric is manufacturing and selling high quality welding equipment, automated welding systems, consumables, and cutting equipment. Our challenge is to meet the needs of our customers, who are experts in their fields, and to exceed their expectations. On occasion, purchasers may ask Lincoln Electric for information or technical information about their use of our products. Our employees respond to inquiries to the best of their ability based on information and specifications provided to them by the customers and the knowledge they may have concerning the application. Our employees, however, are not in a position to verify the information provided or to evaluate the engineering requirements for the particular weldment, or to provide engineering advice in relation to a specific situation. Accordingly, Lincoln Electric does not warrant or guarantee or assume any liability with respect to such information or communications. Moreover, the provision of such information or technical information does not create, expand, or alter any warranty on our products. Any express or implied warranty that might arise from the information or technical information, including any implied warranty of merchantability or any warranty of fitness for any customers' particular purpose or any other equivalent or similar warranty is specifically disclaimed.

Lincoln Electric is a responsive manufacturer, but the definition of specifications, and the selection and use of specific products sold by Lincoln Electric is solely within the control of, and remains the sole responsibility of the customer. Many variables beyond the control of Lincoln Electric affect the results obtained in applying these types of fabrication methods and service requirements.

Risk Assessment Definitions

System risk assessment performed per the requirements of ANSI RIA R15.06-2012 (ISO10218-2) Robots and robotic devices — Safety requirements for industrial robots — Part 2: Robot systems and integration, Article 5.11.2a Collaborative robot operation general requirements.

System risk assessment conducted accordingly to RIA TR R15.306-2016 Task-Based Risk Assessment Methodology and centered on the risk level decision matrix with subsequent risk mitigation and reduction:

Severity of Injury	Exposure to the Hazard	Avoidance of the Hazard	Risk Level
S1 - Minor	E0 - Prevented		NEGLIGIBLE
	E1 - Low	A1 - Likely	
	E2 - High	A2/A3 - Not likely/ Not possible	LOW
S2 - Moderate	E0 - Prevented		MEDIUM
	E1 - Low		
	E2 - High	A1 - Likely A2/A3 - Not likely/ Not possible	HIGH
S3 - Serious	E0 - Prevented		LOW
	E1 - Low		HIGH
	E2 - High	A1/A2 - Likely/Not likely A3 - Not possible	

FANUC CRX-10iA and CRX-10iA/L robotic arms used on this equipment are Power and Force Limiting devices constructed in accordance with ISO/TS 15066:2016 Robots and robotic devices — Collaborative robots. It only allows movements at slower speeds and limited force in order to stay within the collaborative mode of operation based on onset of Pain Study centered on Transient and Quasi-Static values of Contact Speed Limits based on these thresholds:

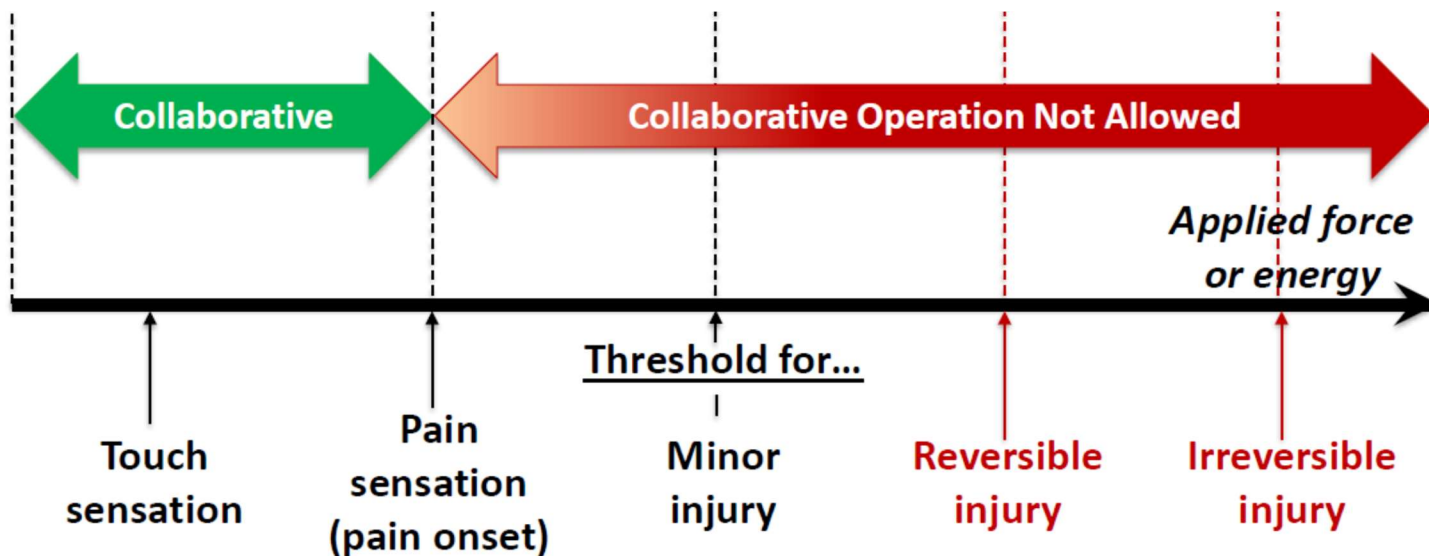

The thresholds are established on acceptable and unacceptable forces or pressures:

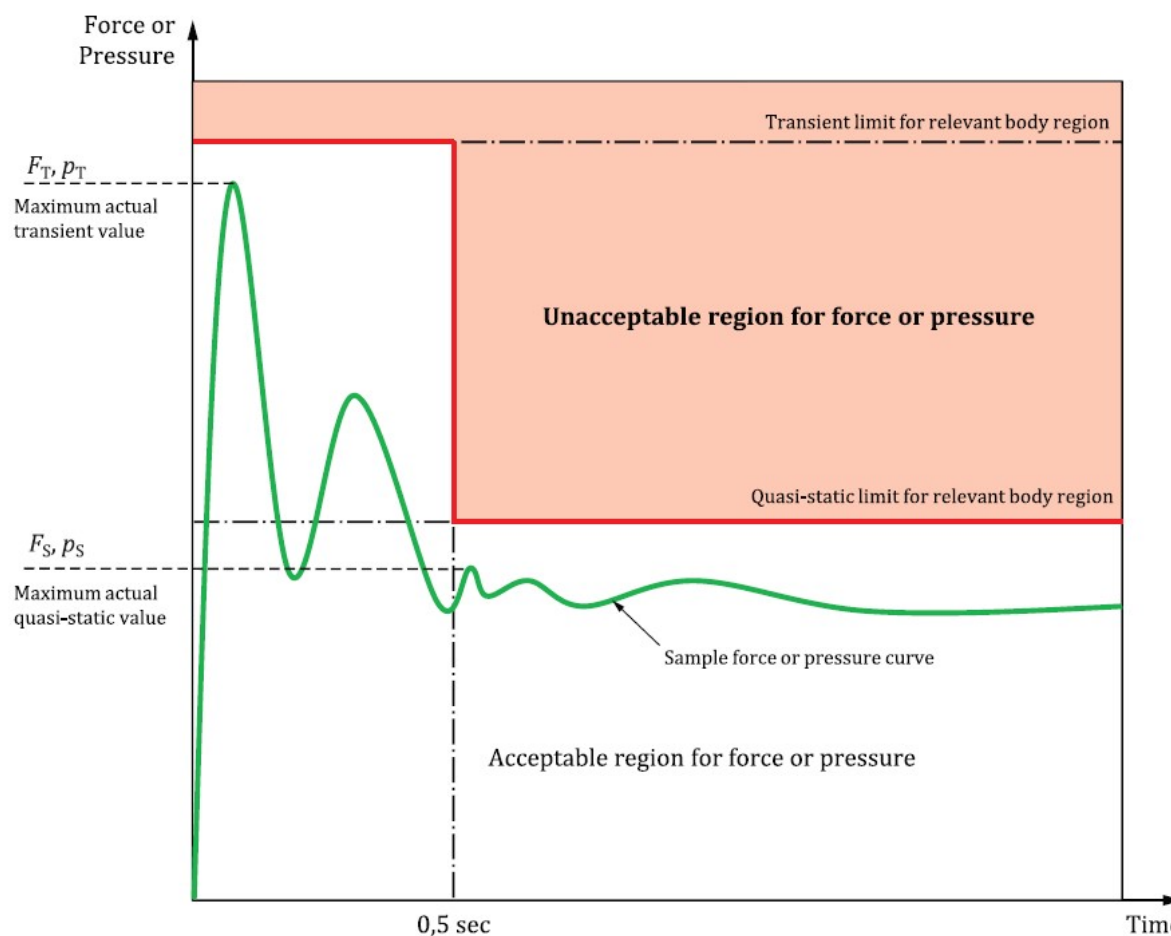

Acceptable and unacceptable forces or pressures are recognized upon calculated speed limit based on a human body model:

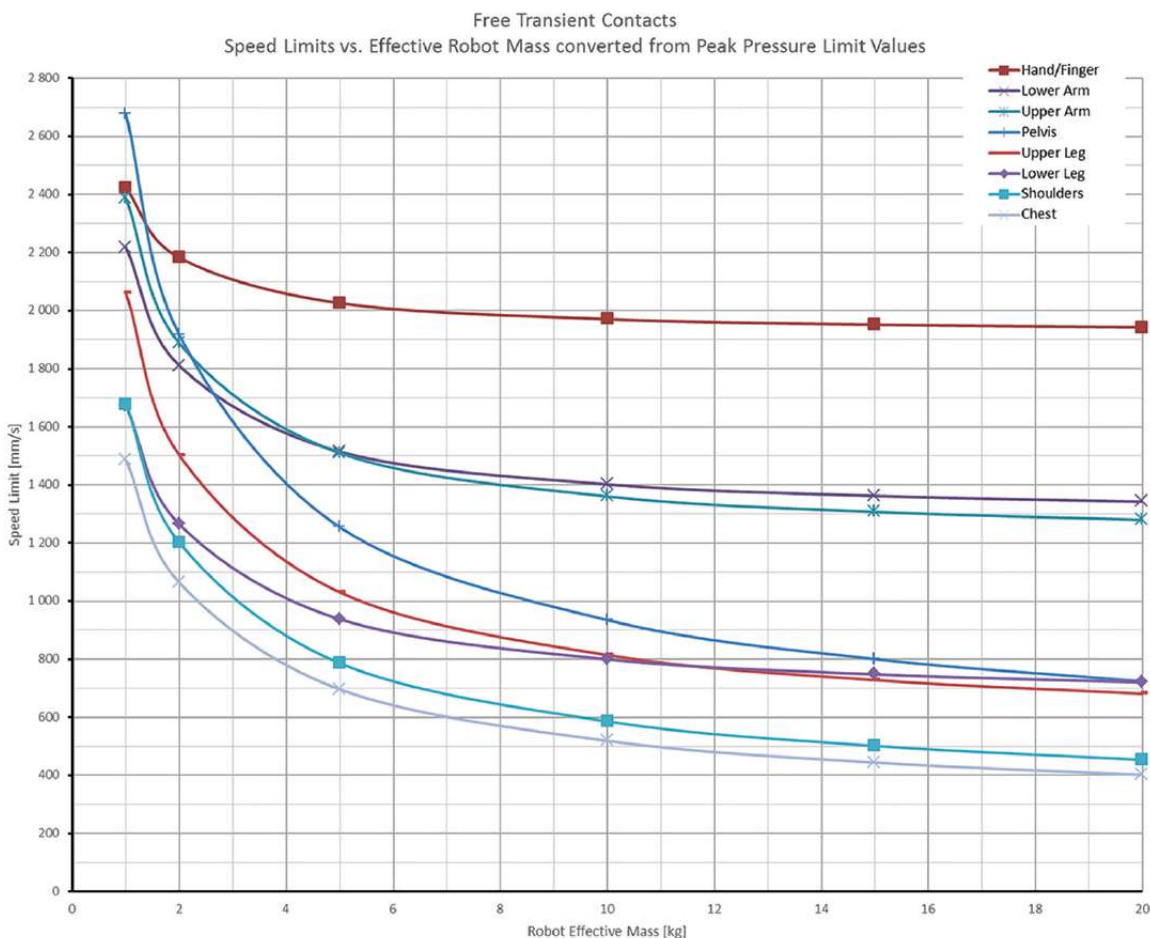

Human body regions tested for the acceptable thresholds of forces and pressures:

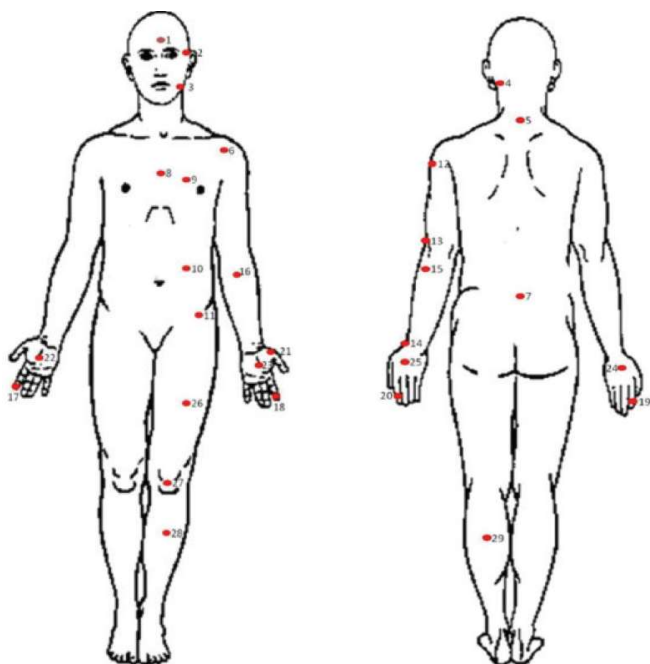

Body Region	Specific Body Area	
Skull and forehead	1	Middle of forehead
	2	Temple
Face	3	Masticatory muscle
Neck	4 to 5	multiple
Back and shoulders	6 to 7	multiple
Chest	8 to 9	multiple
Abdomen	10	Abdominal muscle
Pelvis	11	Pelvic bone
Upper arms & elbow joints	12 to 16	multiple
Lower arms and wrist joints	14 and 15	multiple
Hands and fingers	17 to 25	multiple
Thighs and knees	26 to 27	multiple
Lower legs	28 to 29	multiple

CRX COBOT CART Risk Assessment

Risk Assessment Document													
Customer:	END USER	Safety Lead: LE AUTO CLE					Limitations/Exclusions/Comments:			Collaborative Welding Robotic Cart.			
Job Number:	COOPER™ COBOT CART	Lead Mechanical Engineer: LE AUTO CLE					Risk Scoring System:			ANSI RIA R15.06-2012 5.11 (ISO10218-2), RIA TR 15.306-2016			
Project Manager:	LE AUTO CLE	Lead Electrical Engineer: LE AUTO CLE											
Date of Origin:	2/15/2022												

USER	TASK	EQUIPMENT	TYPE	HAZARD		INITIAL RISK MATRIX				SAFETY RECOMMENDATIONS	SAFEGUARD(S) USED	MITIGATED RISK				COMMENTS		
				POTENTIAL CONSEQUENCES	ORIGIN	S	E	A	Risk Level			PL	Cat.	S	E		A	Risk Level
All Users	Feeding, filling, loading of raw material	Robot	Mechanical	Moving Elements	Entanglement	S1	E1	A2	Low	c	2	Enabling Switch Robot Safety Software Using Correct Operating Procedures Collaborative Robot Status Display Power and Force Limited Robot	Enabling Switch Robot Safety Software Using Correct Operating Procedures Collaborative Robot Status Display Power and Force Limited Robot	S1	E1	A1	Negligible	End-user responsibilities are to conduct operational, ergonomic and safety-related training courses, provide appropriate to welding robotic processes PPE, maintenance and operating procedures, LOTO hardware and procedures, to keep the equipment in clean conditions.
All Users	Feeding, filling, loading of raw material	Torch (Robot End Effector)	Thermal	Objects or Materials with a High or Low Temperature	Burn	S1	E1	A1	Negligible	c	1	Hard Guarding Weld Screens PPE Visual Warning Using Correct Operating Procedures	Visual Warning Using Correct Operating Procedures Labels on Fixtures/Electrical connections	S1	E1	A1	Negligible	
All Users	Feeding, filling, loading of raw material	Torch (Robot End Effector)	Electrical	Arc	Shock	S1	E1	A1	Negligible	c	1	Hard Guarding Reduced Welding Voltages Shields on Tooling Fixtures Low Voltage on Fixtures	Reduced Welding Voltages	S1	E1	A1	Negligible	Weld wire spool to be fully enclosed. Uninterrupted conduit for wire going to feeder. Provided welding gear with output voltage less than 100 Volt per OSHA 1910.254(b)(3)(ii)(B) Automatic (machine or mechanized) arc welding and cutting
All Users	Feeding, filling, loading of raw material	Weld Cell Floor Area	Environmental	Surface Finish	Slipping or tripping	S1	E1	A1	Negligible	c	1	Hard Guarding Safety Scanner Safety Light Curtain Roll Up Door Lift Assist Equipment Weld Screens PPE Visual Warning Lighting Using Correct Operating Procedures Shields on Tooling Fixtures Daily Floor Cleaning	PPE Daily Floor Cleaning	S1	E1	A1	Negligible	End-user responsibilities are to conduct operational, ergonomic and safety-related training courses, provide appropriate to welding robotic processes PPE, maintenance and operating procedures, LOTO hardware and procedures, to keep the equipment in clean conditions.
All Users	Manual loading/unloading	Robot	Mechanical	Moving Elements	Entanglement	S1	E1	A2	Low	c	2	Enabling Switch Robot Safety Software Using Correct Operating Procedures Collaborative Robot Status Display Power and Force Limited Robot	Enabling Switch Robot Safety Software Using Correct Operating Procedures Collaborative Robot Status Display Power and Force Limited Robot	S1	E1	A1	Negligible	End-user responsibilities are to conduct operational, ergonomic and safety-related training courses, provide appropriate to welding robotic processes PPE, maintenance and operating procedures, LOTO hardware and procedures, to keep the equipment in clean conditions.
All Users	Manual loading/unloading	Torch (Robot End Effector)	Thermal	Objects or Materials with a High or Low Temperature	Burn	S1	E1	A1	Negligible	c	1	Hard Guarding Weld Screens PPE Visual Warning Using Correct Operating Procedures	Visual Warning Using Correct Operating Procedures Labels on Fixtures/Electrical connections	S1	E1	A1	Negligible	
All Users	Manual loading/unloading	Torch (Robot End Effector)	Electrical	Arc	Shock	S1	E1	A1	Negligible	c	1	Hard Guarding Reduced Welding Voltages Shields on Tooling Fixtures Low Voltage on Fixtures	Reduced Welding Voltages	S1	E1	A1	Negligible	Weld wire spool to be fully enclosed. Uninterrupted conduit for wire going to feeder. Provided welding gear with output voltage less than 100 Volt per OSHA 1910.254(b)(3)(ii)(B) Automatic (machine or mechanized) arc welding and cutting
All Users	Manual loading/unloading	Weld Cell Floor Area	Environmental	Surface Finish	Slipping or tripping	S1	E1	A1	Negligible	c	1	Hard Guarding Safety Scanner Safety Light Curtain Roll Up Door Lift Assist Equipment Weld Screens PPE Visual Warning Lighting Using Correct Operating Procedures Shields on Tooling Fixtures Daily Floor Cleaning	PPE Daily Floor Cleaning	S1	E1	A1	Negligible	End-user responsibilities are to conduct operational, ergonomic and safety-related training courses, provide appropriate to welding robotic processes PPE, maintenance and operating procedures, LOTO hardware and procedures, to keep the equipment in clean conditions.
All Users	Verification of parts, components, devices	Robot	Mechanical	Moving Elements	Entanglement	S1	E1	A2	Low	c	2	Enabling Switch Robot Safety Software Using Correct Operating Procedures Collaborative Robot Status Display Power and Force Limited Robot	Enabling Switch Robot Safety Software Using Correct Operating Procedures Collaborative Robot Status Display Power and Force Limited Robot	S1	E1	A1	Negligible	End-user responsibilities are to conduct operational, ergonomic and safety-related training courses, provide appropriate to welding robotic processes PPE, maintenance and operating procedures, LOTO hardware and procedures, to keep the equipment in clean conditions.
All Users	Verification of parts, components, devices	Torch (Robot End Effector)	Thermal	Objects or Materials with a High or Low Temperature	Burn	S1	E1	A1	Negligible	c	1	Hard Guarding Weld Screens PPE Visual Warning Using Correct Operating Procedures	Visual Warning Using Correct Operating Procedures Labels on Fixtures/Electrical connections	S1	E1	A1	Negligible	
All Users	Verification of parts, components, devices	Torch (Robot End Effector)	Electrical	Arc	Shock	S1	E1	A1	Negligible	c	1	Hard Guarding Reduced Welding Voltages Shields on Tooling Fixtures Low Voltage on Fixtures	Reduced Welding Voltages	S1	E1	A1	Negligible	Weld wire spool to be fully enclosed. Uninterrupted conduit for wire going to feeder. Provided welding gear with output voltage less than 100 Volt per OSHA 1910.254(b)(3)(ii)(B) Automatic (machine or mechanized) arc welding and cutting
All Users	Verification of parts, components, devices	Weld Equipment	Custom	Weld Flash	Damage to eyes by visible light; damage to skin and eyes by UV radiation; skin cancer (ARC).	S2	E1	A1	Medium	d	2	Hard Guarding Roll Up Door(s) Weld Screens PPE Visual Warning Using Correct Operating Procedures Shields on Tooling Fixtures	PPE Visual Warning	S2	E1	A1	Medium	End-user responsibilities are to conduct operational and safety-related training courses, provide safety glasses, welding helmets or shields and screens, and advise near-by personnel of welding operations.
All Users	Verification of parts, components, devices	Weld Equipment	Custom	Weld Sparks and Spatter	burns, damage to eyes and to skin	S2	E1	A1	Medium	d	2	Hard Guarding Roll Up Door(s) Weld Screens PPE Visual Warning Using Correct Operating Procedures Shields on Tooling Fixtures	PPE Visual Warning	S2	E1	A1	Medium	End-user responsibilities are to conduct operational, ergonomic and safety-related training courses, provide appropriate to welding robotic processes PPE, maintenance and operating procedures, LOTO hardware and procedures, to keep the equipment in clean conditions.
All Users	Verification of parts, components, devices	Weld Equipment	Custom	Weld Fumes	Chronic Overexposure: potential impaired pulmonary function, kidney and nervous system effects, and lung cancer. Acute Overexposure: potential metal	S2	E1	A1	Medium	d	2	Adequate Fume Extraction PPE/Respiratory Protection Keep Head Out of Fume Using Correct Operating Procedures	PPE Visual Warning	S2	E1	A1	Medium	End-user responsibilities are to conduct periodic exposure assessments and testing to ensure personnel are not overexposed to welding fume, provide appropriate fume extraction/ventilation equipment and respiratory protection unless exposure assessments indicate otherwise. Conduct safety-related training courses.
All Users	Verification of parts, components, devices	Weld Equipment	Custom	Welding Gases	nausea, dizziness, or eye, nose and throat irritation	S2	E1	A1	Medium	d	2	Adequate Fume Extraction PPE/Respiratory Protection Keep Head Out of Fume Using Correct Operating Procedures	PPE Visual Warning	S2	E1	A1	Medium	End-user responsibilities are to conduct periodic exposure assessments and testing to ensure personnel are not overexposed to welding fume, provide appropriate fume extraction/ventilation equipment and respiratory protection unless exposure assessments indicate otherwise. Conduct safety-related training courses.
All Users	Verification of parts, components, devices	Weld Cell Floor Area	Environmental	Surface Finish	Slipping or tripping	S1	E1	A1	Negligible	c	1	Hard Guarding Safety Scanner Safety Light Curtain Roll Up Door Lift Assist Equipment Weld Screens PPE Visual Warning Lighting Using Correct Operating Procedures Shields on Tooling Fixtures Daily Floor Cleaning	PPE Daily Floor Cleaning	S1	E1	A1	Negligible	End-user responsibilities are to conduct operational, ergonomic and safety-related training courses, provide appropriate to welding robotic processes PPE, maintenance and operating procedures, LOTO hardware and procedures, to keep the equipment in clean conditions.
All Users	Cleaning, disinfection	Robot	Mechanical	Moving Elements	Entanglement	S1	E1	A2	Low	c	2	Enabling Switch Robot Safety Software Using Correct Operating Procedures Collaborative Robot Status Display Power and Force Limited Robot	Enabling Switch Robot Safety Software Using Correct Operating Procedures Collaborative Robot Status Display Power and Force Limited Robot	S1	E1	A1	Negligible	End-user responsibilities are to conduct operational, ergonomic and safety-related training courses, provide appropriate to welding robotic processes PPE, maintenance and operating procedures, LOTO hardware and procedures, to keep the equipment in clean conditions.

Risk Assessment Document																	
Customer: END USER		Safety Lead: LE AUTO CLE				Limitations/Exclusions/Comments:				Collaborative Welding Robotic Cart.							
Job Number: COOPER™ COBOT CART		Lead Mechanical Engineer: LE AUTO CLE				Risk Scoring System:				ANSI RIA R15.06-2012 5.11 (ISO10218-2), RIA TR R15.306-2016							
Project Manager: LE AUTO CLE		Lead Electrical Engineer: LE AUTO CLE															
Date of Origin: 2/15/2022																	
USER	TASK	EQUIPMENT	TYPE	ORIGIN	HAZARD	POTENTIAL CONSEQUENCES	INITIAL RISK MATRIX				SAFETY RECOMMENDATIONS	SAFEGUARD(S) USED	MITIGATED RISK				COMMENTS
							S	E	A	Risk Level			PLR	Cat.	S	E	

All Users	Cleaning, disinfection	Torch (Robot End Effector)	Thermal	Objects or Materials with a High or Low Temperature	Burn	S1	E1	A1	Negligible	c	1	Hard Guarding Weld Screens PPE Visual Warning Using Correct Operating Procedures	Visual Warning Using Correct Operating Procedures Labels on Features/Electrical connections	S1	E1	A1	Negligible	
All Users	Cleaning, disinfection	Weld Equipment	Custom	Weld Flash	Damage to eyes by visible light; damage to skin and eyes by UV radiation; skin cancer (ARC).	S2	E1	A1	Medium	d	2	Hard Guarding Roll Up Door(s) Weld Screens PPE Visual Warning Using Correct Operating Procedures Shields on Tooling Features	PPE Visual Warning	S2	E1	A1	Medium	End-user responsibilities are to conduct operational and safety-related training courses, provide safety glasses, welding helmets or shields and screens, and advise near-by personnel of welding operations.
All Users	Cleaning, disinfection	Weld Equipment	Custom	Weld Sparks and Spatter	burns, damage to eyes and to skin	S2	E1	A1	Medium	d	2	Hard Guarding Roll Up Door(s) Weld Screens PPE Visual Warning Using Correct Operating Procedures Shields on Tooling Features	PPE Visual Warning	S2	E1	A1	Medium	End-user responsibilities are to conduct operational, ergonomic and safety-related training courses, provide appropriate to welding robotic processes PPE, maintenance and operating procedures, LOTO hardware and procedures, to keep the equipment in clean conditions.
All Users	Cleaning, disinfection	Weld Equipment	Custom	Weld Fumes	Chronic Overexposure: potential impaired pulmonary function, kidney and nervous system effects; and lung cancer. Acute Overexposure: potential metal	S2	E1	A1	Medium	d	2	Adequate Fume Extraction Adequate Ventilation PPE/Respiratory Protection Keep Head Out of Fume Using Correct Operating Procedures	PPE Visual Warning	S2	E1	A1	Medium	End-user responsibilities are to conduct periodic exposure assessments and testing to ensure personnel are not overexposed to welding fume, provide appropriate fume extraction/ventilation equipment and respiratory protection unless exposure assessments indicate otherwise. Conduct safety-related training courses.
All Users	Cleaning, disinfection	Weld Equipment	Custom	Welding Gases	nausea, dizziness, or eye, nose and throat irritation	S2	E1	A1	Medium	d	2	Adequate Fume Extraction PPE/Respiratory Protection Keep Head Out of Fume Using Correct Operating Procedures	PPE Visual Warning	S2	E1	A1	Medium	End-user responsibilities are to conduct periodic exposure assessments and testing to ensure personnel are not overexposed to welding fume, provide appropriate fume extraction/ventilation equipment and respiratory protection unless exposure assessments indicate otherwise. Conduct safety-related training courses.
All Users	Cleaning, disinfection	Weld Cell Floor Area	Environmental	Surface Finish	Slipping or tripping	S1	E1	A1	Negligible	c	1	Hard Guarding Safety Scanner Safety Light Curtain Roll Up Door Lift Assist Equipment Weld Screens Visual Warning Lighting Using Correct Operating Procedures Shields on Tooling Features Daily Floor Cleaning	PPE Daily Floor Cleaning	S1	E1	A1	Negligible	End-user responsibilities are to conduct operational, ergonomic and safety-related training courses, provide appropriate to welding robotic processes PPE, maintenance and operating procedures, LOTO hardware and procedures, to keep the equipment in clean conditions.
All Users	Minor interventions during operation	Robot	Mechanical	Moving Elements	Entanglement	S1	E1	A2	Low	c	2	Enabling Switch Robot Safety Software Using Correct Operating Procedures Collaborative Robot Status Display Power and Force Limited Robot	Enabling Switch Robot Safety Software Using Correct Operating Procedures Collaborative Robot Status Display Power and Force Limited Robot	S1	E1	A1	Negligible	End-user responsibilities are to conduct operational, ergonomic and safety-related training courses, provide appropriate to welding robotic processes PPE, maintenance and operating procedures, LOTO hardware and procedures, to keep the equipment in clean conditions.
All Users	Minor interventions during operation	Torch (Robot End Effector)	Mechanical	Moving Elements	Puncturing	S1	E2	A1	Low	c	2	Hard Guarding Safety Scanner(s) Safety Light Curtain(s) Interlocked Door/Gate(s) Muting Circuit(s) Using Correct Operating Procedures FLC/PMC Interlock	PPE Robot Safety Software Using Correct Operating Procedures	S1	E2	A1	Low	End-user responsibilities are to conduct operational, ergonomic and safety-related training courses, provide appropriate to welding robotic processes PPE, maintenance and operating procedures, LOTO hardware and procedures, to keep the equipment in clean conditions.
All Users	Minor interventions during operation	Torch (Robot End Effector)	Radiation	Weld Flash	Damage to Eyes	S1	E2	A1	Low	c	2	Hard Guarding Weld Screens PPE Visual Warning Using Correct Operating Procedures	PPE Visual Warning Using Correct Operating Procedures	S1	E2	A1	Low	Machine builder is not fully capable of reducing the risk of exposure because there is no guarantee that PPE is used at all times and the operator follows operating procedures.
All Users	Minor interventions during operation	Torch (Robot End Effector)	Thermal	Objects or Materials with a High or Low Temperature	Burn	S1	E1	A1	Negligible	c	1	Hard Guarding Weld Screens PPE Visual Warning Using Correct Operating Procedures	Visual Warning Using Correct Operating Procedures Labels on Features/Electrical connections	S1	E1	A1	Negligible	
All Users	Minor interventions during operation	Torch (Robot End Effector)	Electrical	Arc	Shock	S1	E1	A1	Negligible	c	1	Hard Guarding Reduced Welding Voltages Shields on Tooling Features Low Voltage on Features	Reduced Welding Voltages	S1	E1	A1	Negligible	Weld wire spool to be fully enclosed. Uninterrupted conduit for wire going to feeder. Provided welding gear with output voltage less than 100 Volt per OSHA 1910.254(b)(3)(i)(B) Automatic (machine or mechanized) arc welding and cutting
All Users	Minor interventions during operation	Weld Cell Floor Area	Environmental	Surface Finish	Slipping or tripping	S1	E1	A1	Negligible	c	1	Hard Guarding Safety Scanner Safety Light Curtain Roll Up Door Lift Assist Equipment Weld Screens PPE Visual Warning Lighting Using Correct Operating Procedures Shields on Tooling Features Daily Floor Cleaning	PPE Daily Floor Cleaning	S1	E1	A1	Negligible	End-user responsibilities are to conduct operational, ergonomic and safety-related training courses, provide appropriate to welding robotic processes PPE, maintenance and operating procedures, LOTO hardware and procedures, to keep the equipment in clean conditions.
All Users	Walking By	Robot	Mechanical	Moving Elements	Crushing	S1	E1	A2	Low	c	2	Enabling Switch Visual Warning Lighting Robot Safety Software Using Correct Operating Procedures Collaborative Robot Status Display Power and Force Limited Robot	Enabling Switch Visual Warning Lighting Robot Safety Software Using Correct Operating Procedures Collaborative Robot Status Display Power and Force Limited Robot	S1	E1	A1	Negligible	End-user responsibilities are to conduct operational, ergonomic and safety-related training courses, provide appropriate to welding robotic processes PPE, maintenance and operating procedures, LOTO hardware and procedures, to keep the equipment in clean conditions.
All Users	Walking By	Torch (Robot End Effector)	Thermal	Objects or Materials with a High or Low Temperature	Burn	S1	E1	A1	Negligible	c	1	Hard Guarding Weld Screens PPE Visual Warning Using Correct Operating Procedures	Visual Warning Using Correct Operating Procedures Labels on Features/Electrical connections	S1	E1	A1	Negligible	
All Users	Walking By	Torch (Robot End Effector)	Electrical	Arc	Shock	S1	E1	A1	Negligible	c	1	Hard Guarding Reduced Welding Voltages Shields on Tooling Features Low Voltage on Features	Reduced Welding Voltages	S1	E1	A1	Negligible	Weld wire spool to be fully enclosed. Uninterrupted conduit for wire going to feeder. Provided welding gear with output voltage less than 100 Volt per OSHA 1910.254(b)(3)(i)(B) Automatic (machine or mechanized) arc welding and cutting
All Users	Walking By	Weld Equipment	Custom	Weld Flash	Damage to eyes by visible light; damage to skin and eyes by UV radiation; skin cancer (ARC).	S2	E1	A1	Medium	d	2	Hard Guarding Roll Up Door(s) Weld Screens PPE Visual Warning Using Correct Operating Procedures Shields on Tooling Features	PPE Visual Warning	S2	E1	A1	Medium	End-user responsibilities are to conduct operational and safety-related training courses, provide safety glasses, welding helmets or shields and screens, and advise near-by personnel of welding operations.

Risk Assessment Document																	
Customer: END USER		Safety Lead: LE AUTO CLE				Limitations/Exclusions/Comments:				Collaborative Welding Robotic Cart.							
Job Number: COOPER™ COBOT CART		Lead Mechanical Engineer: LE AUTO CLE				Risk Scoring System:				ANSI RIA R15.06-2012 5.11 (ISO10218-2), RIA TR R15.306-2016							
Project Manager: LE AUTO CLE		Lead Electrical Engineer: LE AUTO CLE															
Date of Origin: 2/15/2022																	
USER	TASK	EQUIPMENT	TYPE	ORIGIN	HAZARD	POTENTIAL CONSEQUENCES	INITIAL RISK MATRIX				SAFETY RECOMMENDATIONS	SAFEGUARD(S) USED	MITIGATED RISK				COMMENTS
							S	E	A	Risk Level			PLr	Cat.	S	E	

All Users	Walking By	Weld Equipment	Custom	Weld Sparks and Spatter	burns, damage to eyes and to skin	S2	E2	A1	Medium	d	2	Hard Guarding Roll Up Door(s) Weld Screens PPE Visual Warning Using Correct Operating Procedures Shields on Tooling Fixtures	PPE Visual Warning	S2	E1	A1	Medium	End-user responsibilities are to conduct operational, ergonomic and safety-related training courses, provide appropriate to welding robotic processes PPE, maintenance and operating procedures, LOTO hardware and procedures, to keep the equipment in clean conditions.
All Users	Walking By	Weld Equipment	Custom	Weld Fumes	Chronic Overexposure: potential impaired pulmonary function, kidney and nervous system effects, and lung cancer. Acute Overexposure: potential metal	S2	E1	A1	Medium	d	2	Adequate Fume Extraction Adequate Ventilation PPE/Respiratory Protection Keep Head Out of Fume Using Correct Operating Procedures	PPE Visual Warning	S2	E1	A1	Medium	End-user responsibilities are to conduct periodic exposure assessments and testing to ensure personnel are not overexposed to welding fume, provide appropriate fume extraction/ventilation equipment and respiratory protection unless exposure assessments indicate otherwise. Conduct safety-related training courses.
All Users	Walking By	Weld Equipment	Custom	Welding Gases	nausea, dizziness, or eye, nose and throat irritation	S2	E1	A1	Medium	d	2	Adequate Fume Extraction Adequate Ventilation PPE/Respiratory Protection Keep Head Out of Fume Using Correct Operating Procedures	PPE Visual Warning	S2	E1	A1	Medium	End-user responsibilities are to conduct periodic exposure assessments and testing to ensure personnel are not overexposed to welding fume, provide appropriate fume extraction/ventilation equipment and respiratory protection unless exposure assessments indicate otherwise. Conduct safety-related training courses.
All Users	Walking By	Weld Cell Floor Area	Environmental	Surface Finish	Slipping or tripping	S1	E1	A1	Negligible	c	1	Hard Guarding Safety Scanner Safety Light Curtain Roll Up Door Lift Assat Equipment Weld Screens PPE Visual Warning Lighting Using Correct Operating Procedures Shields on Tooling Fixtures Daily Floor Cleaning	PPE Daily Floor Cleaning	S1	E1	A1	Negligible	End-user responsibilities are to conduct operational, ergonomic and safety-related training courses, provide appropriate to welding robotic processes PPE, maintenance and operating procedures, LOTO hardware and procedures, to keep the equipment in clean conditions.
Programmer	Adjustment and setting of protective devices	Robot	Mechanical	Moving Elements	Crushing	S1	E1	A2	Low	c	2	Enabling Switch Lighting Robot Safety Software Using Correct Operating Procedures Collaborative Robot Status Display Power and Force Limited Robot	Enabling Switch Lighting Robot Safety Software Using Correct Operating Procedures Collaborative Robot Status Display Power and Force Limited Robot	S1	E1	A1	Negligible	End-user responsibilities are to conduct operational, ergonomic and safety-related training courses, provide appropriate to welding robotic processes PPE, maintenance and operating procedures, LOTO hardware and procedures, to keep the equipment in clean conditions.
Programmer	Adjustment and setting of functional parameters of the machine	Robot	Mechanical	Moving Elements	Crushing	S1	E1	A2	Low	c	2	Enabling Switch Visual Warning Lighting Robot Safety Software Using Correct Operating Procedures Collaborative Robot Status Display Power and Force Limited Robot	Enabling Switch Visual Warning Lighting Robot Safety Software Using Correct Operating Procedures Collaborative Robot Status Display Power and Force Limited Robot	S1	E1	A1	Negligible	End-user responsibilities are to conduct operational, ergonomic and safety-related training courses, provide appropriate to welding robotic processes PPE, maintenance and operating procedures, LOTO hardware and procedures, to keep the equipment in clean conditions.
Programmer	Adjustment and setting of functional parameters of the machine	Weld Equipment	Custom	Weld Flash	Damage to eyes by visible light; damage to skin and eyes by UV radiation; skin cancer (AARC).	S2	E2	A1	Medium	d	2	Hard Guarding Weld Screens PPE Visual Warning Using Correct Operating Procedures Shields on Tooling Fixtures Teach Pendant	PPE Using Correct Operating Procedures Teach Pendant	S2	E2	A1	Medium	End-user responsibilities are to conduct operational and safety-related training courses, provide safety glasses, welding helmets or shields and screens, and advise near-by personnel of welding operators.
Programmer	Adjustment and setting of functional parameters of the machine	Weld Equipment	Custom	Weld Sparks and Spatter	burns, damage to eyes and to skin	S2	E2	A1	Medium	d	2	Hard Guarding Weld Screens PPE Visual Warning Using Correct Operating Procedures Shields on Tooling Fixtures Teach Pendant	PPE Using Correct Operating Procedures Teach Pendant	S2	E1	A1	Medium	End-user responsibilities are to conduct operational, ergonomic and safety-related training courses, provide appropriate to welding robotic processes PPE, maintenance and operating procedures, LOTO hardware and procedures, to keep the equipment in clean conditions.
Programmer	Adjustment and setting of functional parameters of the machine	Weld Equipment	Custom	Weld Fumes	Chronic Overexposure: potential impaired pulmonary function, kidney and nervous system effects, and lung cancer. Acute Overexposure: potential metal fume fever, gastrointestinal	S2	E2	A1	Medium	d	2	Visual Warning Adequate Fume Extraction Adequate Ventilation PPE/Respiratory Protection Keep Head Out of Fume Using Correct Operating Procedures	PPE Using Correct Operating Procedures Teach Pendant	S2	E2	A1	Medium	End-user responsibilities are to conduct periodic exposure assessments and testing to ensure personnel are not overexposed to welding fume, provide appropriate fume extraction/ventilation equipment and respiratory protection unless exposure assessments indicate otherwise. Conduct safety-related training courses.
Programmer	Adjustment and setting of functional parameters of the machine	Weld Equipment	Custom	Welding Gases	nausea, dizziness, or eye, nose and throat irritation	S2	E2	A1	Medium	d	2	Visual Warning Adequate Fume Extraction Adequate Ventilation PPE/Respiratory Protection Keep Head Out of Fume Using Correct Operating Procedures	PPE Using Correct Operating Procedures Teach Pendant	S2	E2	A1	Medium	End-user responsibilities are to conduct periodic exposure assessments and testing to ensure personnel are not overexposed to welding fume, provide appropriate fume extraction/ventilation equipment and respiratory protection unless exposure assessments indicate otherwise. Conduct safety-related training courses.
Programmer	Feeding, filling, loading of raw material	Weld Equipment	Custom	Weld Flash	Damage to eyes by visible light; damage to skin and eyes by UV radiation; skin cancer (AARC).	S2	E2	A1	Medium	d	2	Hard Guarding Weld Screens PPE Visual Warning Using Correct Operating Procedures Shields on Tooling Fixtures Teach Pendant	PPE Using Correct Operating Procedures Teach Pendant	S2	E2	A1	Medium	End-user responsibilities are to conduct operational and safety-related training courses, provide safety glasses, welding helmets or shields and screens, and advise near-by personnel of welding operators.
Programmer	Feeding, filling, loading of raw material	Weld Equipment	Custom	Weld Sparks and Spatter	burns, damage to eyes and to skin	S2	E2	A1	Medium	d	2	Hard Guarding Weld Screens PPE Visual Warning Using Correct Operating Procedures Shields on Tooling Fixtures Teach Pendant	PPE Using Correct Operating Procedures Teach Pendant	S2	E1	A1	Medium	End-user responsibilities are to conduct operational, ergonomic and safety-related training courses, provide appropriate to welding robotic processes PPE, maintenance and operating procedures, LOTO hardware and procedures, to keep the equipment in clean conditions.
Programmer	Feeding, filling, loading of raw material	Weld Equipment	Custom	Weld Fumes	Chronic Overexposure: potential impaired pulmonary function, kidney and nervous system effects, and lung cancer. Acute Overexposure: potential metal fume fever, gastrointestinal	S2	E2	A1	Medium	d	2	Visual Warning Adequate Fume Extraction Adequate Ventilation PPE/Respiratory Protection Keep Head Out of Fume Using Correct Operating Procedures	PPE Using Correct Operating Procedures Teach Pendant	S2	E2	A1	Medium	End-user responsibilities are to conduct periodic exposure assessments and testing to ensure personnel are not overexposed to welding fume, provide appropriate fume extraction/ventilation equipment and respiratory protection unless exposure assessments indicate otherwise. Conduct safety-related training courses.
Programmer	Feeding, filling, loading of raw material	Weld Equipment	Custom	Welding Gases	nausea, dizziness, or eye, nose and throat irritation	S2	E2	A1	Medium	d	2	Visual Warning Adequate Fume Extraction Adequate Ventilation PPE/Respiratory Protection Keep Head Out of Fume Using Correct Operating Procedures	PPE Using Correct Operating Procedures Teach Pendant	S2	E2	A1	Medium	End-user responsibilities are to conduct periodic exposure assessments and testing to ensure personnel are not overexposed to welding fume, provide appropriate fume extraction/ventilation equipment and respiratory protection unless exposure assessments indicate otherwise. Conduct safety-related training courses.
Programmer	Functional test, trials	Robot	Mechanical	Moving Elements	Crushing	S1	E1	A2	Low	c	2	Enabling Switch Visual Warning Lighting Robot Safety Software Using Correct Operating Procedures Collaborative Robot Status Display Power and Force Limited Robot	Enabling Switch Visual Warning Lighting Robot Safety Software Using Correct Operating Procedures Collaborative Robot Status Display Power and Force Limited Robot	S1	E1	A1	Negligible	End-user responsibilities are to conduct operational, ergonomic and safety-related training courses, provide appropriate to welding robotic processes PPE, maintenance and operating procedures, LOTO hardware and procedures, to keep the equipment in clean conditions.
Programmer	Functional test, trials	Weld Equipment	Custom	Weld Flash	Damage to eyes by visible light; damage to skin and eyes by UV radiation; skin cancer (AARC).	S2	E2	A1	Medium	d	2	Hard Guarding Weld Screens PPE Visual Warning Using Correct Operating Procedures Shields on Tooling Fixtures Teach Pendant	PPE Using Correct Operating Procedures Teach Pendant	S2	E2	A1	Medium	End-user responsibilities are to conduct operational and safety-related training courses, provide safety glasses, welding helmets or shields and screens, and advise near-by personnel of welding operators.

Risk Assessment Document																	
Customer: END USER		Safety Lead: LE AUTO CLE				Limitations/Exclusions/Comments:				Collaborative Welding Robotic Cart.							
Job Number: COOPER™ COBOT CART		Lead Mechanical Engineer: LE AUTO CLE				Risk Scoring System:				ANSI RIA R15.06-2012 5.11 (ISO10218-2), RIA TR R15.306-2016							
Project Manager: LE AUTO CLE		Lead Electrical Engineer: LE AUTO CLE															
Date of Origin: 2/15/2022																	
USER	TASK	EQUIPMENT	TYPE	ORIGIN	HAZARD	POTENTIAL CONSEQUENCES	INITIAL RISK MATRIX				SAFETY RECOMMENDATIONS	SAFEGUARD(S) USED	MITIGATED RISK				COMMENTS
							S	E	A	Risk Level			PLr	Cat.	S	E	

Programmer	Functional test, trials	Weld Equipment	Custom	Weld Sparks and Spatter	burns, damage to eyes and to skin	S2	E2	A1	Medium	d	2	Hard Guarding Weld Screens PPE Visual Warning Using Correct Operating Procedures Shields on Tooling Fixtures Teach Pendant	PPE Using Correct Operating Procedures Teach Pendant	S2	E1	A1	Medium	End-user responsibilities are to conduct operational, ergonomic and safety-related training courses, provide appropriate to welding robotic processes PPE, maintenance and operating procedures, LOTO hardware and procedures, to keep the equipment in clean conditions.
Programmer	Functional test, trials	Weld Equipment	Custom	Weld Fumes	Chronic Overexposure: potential impaired pulmonary function, kidney and nervous system effects, and lung cancer. Acute Overexposure: potential metal fume fever, gastrointestinal	S2	E2	A1	Medium	d	2	Visual Warning Adequate Fume Extraction Adequate Ventilation PPE/Respiratory Protection Keep Head Out of Fume Using Correct Operating Procedures	PPE Using Correct Operating Procedures Teach Pendant	S2	E2	A1	Medium	End-user responsibilities are to conduct periodic exposure assessments and testing to ensure personnel are not overexposed to welding fume, provide appropriate fume extraction/ventilation equipment and respiratory protection unless exposure assessments indicate otherwise. Conduct safety-related training courses.
Programmer	Functional test, trials	Weld Equipment	Custom	Welding Gases	nausea, dizziness, or eye, nose and throat irritation	S2	E2	A1	Medium	d	2	Visual Warning Adequate Fume Extraction Adequate Ventilation PPE/Respiratory Protection Keep Head Out of Fume Using Correct Operating Procedures	PPE Using Correct Operating Procedures Teach Pendant	S2	E2	A1	Medium	End-user responsibilities are to conduct periodic exposure assessments and testing to ensure personnel are not overexposed to welding fume, provide appropriate fume extraction/ventilation equipment and respiratory protection unless exposure assessments indicate otherwise. Conduct safety-related training courses.
Programmer	Mounting or changing tools, tool-setting	Weld Equipment	Custom	Weld Flash	Damage to eyes by visible light; damage to skin and eyes by UV radiation; skin cancer (ARC).	S2	E2	A1	Medium	d	2	Hard Guarding Weld Screens PPE Visual Warning Using Correct Operating Procedures Shields on Tooling Fixtures Teach Pendant	PPE Using Correct Operating Procedures Teach Pendant	S2	E1	A1	Medium	End-user responsibilities are to conduct operational and safety-related training courses, provide safety glasses, welding helmets or shields and screens, and advise near-by personnel of welding operations.
Programmer	Mounting or changing tools, tool-setting	Weld Equipment	Custom	Weld Sparks and Spatter	burns, damage to eyes and to skin	S2	E2	A1	Medium	d	2	Hard Guarding Weld Screens PPE Visual Warning Using Correct Operating Procedures Shields on Tooling Fixtures Teach Pendant	PPE Using Correct Operating Procedures Teach Pendant	S2	E1	A1	Medium	End-user responsibilities are to conduct operational, ergonomic and safety-related training courses, provide appropriate to welding robotic processes PPE, maintenance and operating procedures, LOTO hardware and procedures, to keep the equipment in clean conditions.
Programmer	Mounting or changing tools, tool-setting	Weld Equipment	Custom	Weld Fumes	Chronic Overexposure: potential impaired pulmonary function, kidney and nervous system effects, and lung cancer. Acute Overexposure: potential metal fume fever, gastrointestinal	S2	E2	A1	Medium	d	2	Visual Warning Adequate Fume Extraction Adequate Ventilation PPE/Respiratory Protection Keep Head Out of Fume Using Correct Operating Procedures	PPE Using Correct Operating Procedures Teach Pendant	S2	E2	A1	Medium	End-user responsibilities are to conduct periodic exposure assessments and testing to ensure personnel are not overexposed to welding fume, provide appropriate fume extraction/ventilation equipment and respiratory protection unless exposure assessments indicate otherwise. Conduct safety-related training courses.
Programmer	Mounting or changing tools, tool-setting	Weld Equipment	Custom	Welding Gases	nausea, dizziness, or eye, nose and throat irritation	S2	E2	A1	Medium	d	2	Visual Warning Adequate Fume Extraction Adequate Ventilation PPE/Respiratory Protection Keep Head Out of Fume Using Correct Operating Procedures	PPE Using Correct Operating Procedures Teach Pendant	S2	E2	A1	Medium	End-user responsibilities are to conduct periodic exposure assessments and testing to ensure personnel are not overexposed to welding fume, provide appropriate fume extraction/ventilation equipment and respiratory protection unless exposure assessments indicate otherwise. Conduct safety-related training courses.
Programmer	Programming verification	Robot	Mechanical	Moving Elements	Crushing	S1	E1	A2	Low	c	2	Enabling Switch Visual Warning Lighting Robot Safety Software Using Correct Operating Procedures Collaborative Robot Power and Force Limited Robot	Enabling Switch Visual Warning Lighting Robot Safety Software Using Correct Operating Procedures Collaborative Robot Status Display Power and Force Limited Robot	S1	E1	A1	Negligible	End-user responsibilities are to conduct operational, ergonomic and safety-related training courses, provide appropriate to welding robotic processes PPE, maintenance and operating procedures, LOTO hardware and procedures, to keep the equipment in clean conditions.
Programmer	Programming verification	Weld Equipment	Custom	Weld Flash	Damage to eyes by visible light; damage to skin and eyes by UV radiation; skin cancer (ARC).	S2	E2	A1	Medium	d	2	Hard Guarding Weld Screens PPE Visual Warning Using Correct Operating Procedures Shields on Tooling Fixtures Teach Pendant	PPE Using Correct Operating Procedures Teach Pendant	S2	E2	A1	Medium	End-user responsibilities are to conduct operational and safety-related training courses, provide safety glasses, welding helmets or shields and screens, and advise near-by personnel of welding operations.
Programmer	Programming verification	Weld Equipment	Custom	Weld Sparks and Spatter	burns, damage to eyes and to skin	S2	E2	A1	Medium	d	2	Hard Guarding Weld Screens PPE Visual Warning Using Correct Operating Procedures Shields on Tooling Fixtures Teach Pendant	PPE Using Correct Operating Procedures Teach Pendant	S2	E1	A1	Medium	End-user responsibilities are to conduct operational, ergonomic and safety-related training courses, provide appropriate to welding robotic processes PPE, maintenance and operating procedures, LOTO hardware and procedures, to keep the equipment in clean conditions.
Programmer	Programming verification	Weld Equipment	Custom	Weld Fumes	Chronic Overexposure: potential impaired pulmonary function, kidney and nervous system effects, and lung cancer. Acute Overexposure: potential metal fume fever, gastrointestinal	S2	E2	A1	Medium	d	2	Visual Warning Adequate Fume Extraction Adequate Ventilation PPE/Respiratory Protection Keep Head Out of Fume Using Correct Operating Procedures	PPE Using Correct Operating Procedures Teach Pendant	S2	E2	A1	Medium	End-user responsibilities are to conduct periodic exposure assessments and testing to ensure personnel are not overexposed to welding fume, provide appropriate fume extraction/ventilation equipment and respiratory protection unless exposure assessments indicate otherwise. Conduct safety-related training courses.
Programmer	Programming verification	Weld Equipment	Custom	Welding Gases	nausea, dizziness, or eye, nose and throat irritation	S2	E2	A1	Medium	d	2	Visual Warning Adequate Fume Extraction Adequate Ventilation PPE/Respiratory Protection Keep Head Out of Fume Using Correct Operating Procedures	PPE Using Correct Operating Procedures Teach Pendant	S2	E2	A1	Medium	End-user responsibilities are to conduct periodic exposure assessments and testing to ensure personnel are not overexposed to welding fume, provide appropriate fume extraction/ventilation equipment and respiratory protection unless exposure assessments indicate otherwise. Conduct safety-related training courses.
Programmer	Verification of the final product	Weld Equipment	Custom	Weld Flash	Damage to eyes by visible light; damage to skin and eyes by UV radiation; skin cancer (ARC).	S2	E2	A1	Medium	d	2	Hard Guarding Weld Screens PPE Visual Warning Using Correct Operating Procedures Shields on Tooling Fixtures Teach Pendant	PPE Using Correct Operating Procedures Teach Pendant	S2	E2	A1	Medium	End-user responsibilities are to conduct operational and safety-related training courses, provide safety glasses, welding helmets or shields and screens, and advise near-by personnel of welding operations.
Programmer	Verification of the final product	Weld Equipment	Custom	Weld Sparks and Spatter	burns, damage to eyes and to skin	S2	E2	A1	Medium	d	2	Hard Guarding Weld Screens PPE Visual Warning Using Correct Operating Procedures Shields on Tooling Fixtures Teach Pendant	PPE Using Correct Operating Procedures Teach Pendant	S2	E1	A1	Medium	End-user responsibilities are to conduct operational, ergonomic and safety-related training courses, provide appropriate to welding robotic processes PPE, maintenance and operating procedures, LOTO hardware and procedures, to keep the equipment in clean conditions.
Programmer	Verification of the final product	Weld Equipment	Custom	Weld Fumes	Chronic Overexposure: potential impaired pulmonary function, kidney and nervous system effects, and lung cancer. Acute Overexposure: potential metal fume fever, gastrointestinal	S2	E2	A1	Medium	d	2	Visual Warning Adequate Fume Extraction Adequate Ventilation PPE/Respiratory Protection Keep Head Out of Fume Using Correct Operating Procedures	PPE Using Correct Operating Procedures Teach Pendant	S2	E2	A1	Medium	End-user responsibilities are to conduct periodic exposure assessments and testing to ensure personnel are not overexposed to welding fume, provide appropriate fume extraction/ventilation equipment and respiratory protection unless exposure assessments indicate otherwise. Conduct safety-related training courses.
Programmer	Verification of the final product	Weld Equipment	Custom	Welding Gases	nausea, dizziness, or eye, nose and throat irritation	S2	E2	A1	Medium	d	2	Visual Warning Adequate Fume Extraction Adequate Ventilation PPE/Respiratory Protection Keep Head Out of Fume Using Correct Operating Procedures	PPE Using Correct Operating Procedures Teach Pendant	S2	E2	A1	Medium	End-user responsibilities are to conduct periodic exposure assessments and testing to ensure personnel are not overexposed to welding fume, provide appropriate fume extraction/ventilation equipment and respiratory protection unless exposure assessments indicate otherwise. Conduct safety-related training courses.

Risk Assessment Document																				
Customer: END USER		Safety Lead: LE AUTO CLE				Limitations/Exclusions/Comments:				Collaborative Welding Robotic Cart.										
Job Number: COOPER™ COBOT CART		Lead Mechanical Engineer: LE AUTO CLE																		
Project Manager: LE AUTO CLE		Lead Electrical Engineer: LE AUTO CLE				Risk Scoring System:				ANSI RIA R15.06-2012.5.11 (ISO10218-2), RIA TR R15.306-2016										
Date of Origin: 2/15/2022																				
USER	TASK	EQUIPMENT	TYPE	ORIGIN	POTENTIAL CONSEQUENCES	HAZARD				INITIAL RISK MATRIX				SAFETY RECOMMENDATIONS	SAFEGUARD(S) USED	MITIGATED RISK				COMMENTS
						S	E	A	Risk Level	Plr	Cat.	S	E			A	Risk Level			

Operator	Control/Inspection	Robot	Mechanical	Moving Part to a Fixed Part	Crushing	S1	E2	A1	Low	c	2	Enabling Switch Visual Warning Lighting Robot Safety Software Using Correct Operating Procedures Collaborative Robot Status Display Power and Force Limited Robot	Enabling Switch Visual Warning Lighting Robot Safety Software Using Correct Operating Procedures Collaborative Robot Status Display Power and Force Limited Robot	S1	E2	A1	Low	End-user responsibilities are to conduct operational, ergonomic and safety-related training courses, provide appropriate to welding robotic processes PPE, maintenance and operating procedures, LOTO hardware and procedures, to keep the equipment in clean conditions.
Operator	Driving the machine	Robot	Mechanical	Moving Part to a Fixed Part	Crushing	S1	E2	A1	Low	c	2	Enabling Switch Visual Warning Lighting Robot Safety Software Using Correct Operating Procedures Collaborative Robot Status Display Power and Force Limited Robot	Enabling Switch Visual Warning Lighting Robot Safety Software Using Correct Operating Procedures Collaborative Robot Status Display Power and Force Limited Robot	S1	E2	A1	Low	End-user responsibilities are to conduct operational, ergonomic and safety-related training courses, provide appropriate to welding robotic processes PPE, maintenance and operating procedures, LOTO hardware and procedures, to keep the equipment in clean conditions.
Operator	Minor adjustments and setting of functional parameters	Robot	Mechanical	Moving Part to a Fixed Part	Crushing	S1	E2	A1	Low	c	2	Enabling Switch Visual Warning Lighting Robot Safety Software Using Correct Operating Procedures Collaborative Robot Status Display Power and Force Limited Robot	Enabling Switch Visual Warning Lighting Robot Safety Software Using Correct Operating Procedures Collaborative Robot Status Display Power and Force Limited Robot	S1	E2	A1	Low	End-user responsibilities are to conduct operational, ergonomic and safety-related training courses, provide appropriate to welding robotic processes PPE, maintenance and operating procedures, LOTO hardware and procedures, to keep the equipment in clean conditions.
Operator	Minor interventions during operation	Robot	Mechanical	Moving Part to a Fixed Part	Crushing	S1	E2	A1	Low	c	2	Enabling Switch Visual Warning Lighting Robot Safety Software Using Correct Operating Procedures Collaborative Robot Status Display Power and Force Limited Robot	Enabling Switch Visual Warning Lighting Robot Safety Software Using Correct Operating Procedures Collaborative Robot Status Display Power and Force Limited Robot	S1	E2	A1	Low	End-user responsibilities are to conduct operational, ergonomic and safety-related training courses, provide appropriate to welding robotic processes PPE, maintenance and operating procedures, LOTO hardware and procedures, to keep the equipment in clean conditions.
Operator	Operating manual controls	Robot	Mechanical	Moving Part to a Fixed Part	Crushing	S1	E2	A1	Low	c	2	Enabling Switch Visual Warning Lighting Robot Safety Software Using Correct Operating Procedures Collaborative Robot Status Display Power and Force Limited Robot	Enabling Switch Visual Warning Lighting Robot Safety Software Using Correct Operating Procedures Collaborative Robot Status Display Power and Force Limited Robot	S1	E2	A1	Low	End-user responsibilities are to conduct operational, ergonomic and safety-related training courses, provide appropriate to welding robotic processes PPE, maintenance and operating procedures, LOTO hardware and procedures, to keep the equipment in clean conditions.
Operator	Restarting the machine after stopping/interruption	Robot	Mechanical	Moving Part to a Fixed Part	Crushing	S1	E2	A1	Low	c	2	Enabling Switch Visual Warning Lighting Robot Safety Software Using Correct Operating Procedures Collaborative Robot Status Display Power and Force Limited Robot	Enabling Switch Visual Warning Lighting Robot Safety Software Using Correct Operating Procedures Collaborative Robot Status Display Power and Force Limited Robot	S1	E2	A1	Low	End-user responsibilities are to conduct operational, ergonomic and safety-related training courses, provide appropriate to welding robotic processes PPE, maintenance and operating procedures, LOTO hardware and procedures, to keep the equipment in clean conditions.
Maintenance	Adjustments	Robot	Mechanical	Moving Elements	Crushing	S1	E1	A2	Low	c	2	Enabling Switch Visual Warning Lighting Robot Safety Software Using Correct Operating Procedures Collaborative Robot Status Display Power and Force Limited Robot	Enabling Switch Visual Warning Lighting Robot Safety Software Using Correct Operating Procedures Collaborative Robot Status Display Power and Force Limited Robot	S1	E1	A2	Negligible	End-user responsibilities are to conduct operational, ergonomic and safety-related training courses, provide appropriate to welding robotic processes PPE, maintenance and operating procedures, LOTO hardware and procedures, to keep the equipment in clean conditions.
Maintenance	Cleaning, disinfection	Electrical Equipment	Electrical	Live Parts	Shock	S3	E1	A1	High	d	3	Enabling Switch Visual Warning Lighting Robot Safety Software Using Correct Operating Procedures Safety Enclosure with Interlocked Door Low Voltage on Fixtures Labels on Fixtures/Electrical connections Circuit Breaker Protection Status Display	Enabling Switch Visual Warning Lighting Robot Safety Software Using Correct Operating Procedures Safety Enclosure with Interlocked Door Low Voltage on Fixtures Labels on Fixtures/Electrical connections Circuit Breaker Protection Status Display	S2	E0	A1	Low	End-user responsibilities are to conduct operational, ergonomic and safety-related training courses, provide appropriate to welding robotic processes PPE, maintenance and operating procedures, LOTO hardware and procedures, to keep the equipment in clean conditions.
Maintenance	Dismantling/removal of parts, components, devices of the machine	Robot	Mechanical	Moving Elements	Crushing	S1	E1	A2	Low	c	2	Enabling Switch Visual Warning Lighting Robot Safety Software Using Correct Operating Procedures Collaborative Robot Status Display Power and Force Limited Robot	Enabling Switch Visual Warning Lighting Robot Safety Software Using Correct Operating Procedures Collaborative Robot Status Display Power and Force Limited Robot	S1	E1	A2	Negligible	End-user responsibilities are to conduct operational, ergonomic and safety-related training courses, provide appropriate to welding robotic processes PPE, maintenance and operating procedures, LOTO hardware and procedures, to keep the equipment in clean conditions.
Maintenance	Housekeeping	Electrical Equipment	Electrical	Live Parts	Shock	S3	E1	A1	High	d	3	Enabling Switch Visual Warning Lighting Robot Safety Software Using Correct Operating Procedures Safety Enclosure with Interlocked Door Low Voltage on Fixtures Labels on Fixtures/Electrical connections Circuit Breaker Protection Status Display	Enabling Switch Visual Warning Lighting Robot Safety Software Using Correct Operating Procedures Safety Enclosure with Interlocked Door Low Voltage on Fixtures Labels on Fixtures/Electrical connections Circuit Breaker Protection Status Display	S2	E0	A1	Low	End-user responsibilities are to conduct operational, ergonomic and safety-related training courses, provide appropriate to welding robotic processes PPE, maintenance and operating procedures, LOTO hardware and procedures, to keep the equipment in clean conditions.
Maintenance	Isolation and energy dissipation	Robot	Mechanical	Moving Elements	Crushing	S1	E1	A2	Low	c	2	Enabling Switch Visual Warning Lighting Robot Safety Software Using Correct Operating Procedures Collaborative Robot Status Display Power and Force Limited Robot	Enabling Switch Visual Warning Lighting Robot Safety Software Using Correct Operating Procedures Collaborative Robot Status Display Power and Force Limited Robot	S1	E1	A2	Negligible	End-user responsibilities are to conduct operational, ergonomic and safety-related training courses, provide appropriate to welding robotic processes PPE, maintenance and operating procedures, LOTO hardware and procedures, to keep the equipment in clean conditions.
Maintenance	Isolation and energy dissipation	Electrical Equipment	Electrical	Live Parts	Shock	S3	E1	A1	High	d	3	Enabling Switch Visual Warning Lighting Robot Safety Software Using Correct Operating Procedures Safety Enclosure with Interlocked Door Low Voltage on Fixtures Labels on Fixtures/Electrical connections Circuit Breaker Protection Status Display	Enabling Switch Visual Warning Lighting Robot Safety Software Using Correct Operating Procedures Safety Enclosure with Interlocked Door Low Voltage on Fixtures Labels on Fixtures/Electrical connections Circuit Breaker Protection Status Display	S2	E0	A1	Low	End-user responsibilities are to conduct operational, ergonomic and safety-related training courses, provide appropriate to welding robotic processes PPE, maintenance and operating procedures, LOTO hardware and procedures, to keep the equipment in clean conditions.
Maintenance	Replacement of worn parts	Electrical Equipment	Electrical	Live Parts	Shock	S3	E1	A1	High	d	3	Enabling Switch Visual Warning Lighting Robot Safety Software Using Correct Operating Procedures Safety Enclosure with Interlocked Door Low Voltage on Fixtures Labels on Fixtures/Electrical connections Circuit Breaker Protection Status Display	Enabling Switch Visual Warning Lighting Robot Safety Software Using Correct Operating Procedures Safety Enclosure with Interlocked Door Low Voltage on Fixtures Labels on Fixtures/Electrical connections Circuit Breaker Protection Status Display	S2	E0	A1	Low	End-user responsibilities are to conduct operational, ergonomic and safety-related training courses, provide appropriate to welding robotic processes PPE, maintenance and operating procedures, LOTO hardware and procedures, to keep the equipment in clean conditions.
Maintenance	Resetting	Electrical Equipment	Electrical	Live Parts	Shock	S3	E1	A1	High	d	3	Enabling Switch Visual Warning Lighting Robot Safety Software Using Correct Operating Procedures Safety Enclosure with Interlocked Door Low Voltage on Fixtures Labels on Fixtures/Electrical connections Circuit Breaker Protection Status Display	Enabling Switch Visual Warning Lighting Robot Safety Software Using Correct Operating Procedures Safety Enclosure with Interlocked Door Low Voltage on Fixtures Labels on Fixtures/Electrical connections Circuit Breaker Protection Status Display	S2	E0	A1	Low	End-user responsibilities are to conduct operational, ergonomic and safety-related training courses, provide appropriate to welding robotic processes PPE, maintenance and operating procedures, LOTO hardware and procedures, to keep the equipment in clean conditions.
Maintenance	Verification of parts, components, devices of the machine	Electrical Equipment	Electrical	Live Parts	Shock	S3	E1	A1	High	d	3	Enabling Switch Visual Warning Lighting Robot Safety Software Using Correct Operating Procedures Safety Enclosure with Interlocked Door Low Voltage on Fixtures Labels on Fixtures/Electrical connections Circuit Breaker Protection Status Display	Enabling Switch Visual Warning Lighting Robot Safety Software Using Correct Operating Procedures Safety Enclosure with Interlocked Door Low Voltage on Fixtures Labels on Fixtures/Electrical connections Circuit Breaker Protection Status Display	S2	E0	A1	Low	End-user responsibilities are to conduct operational, ergonomic and safety-related training courses, provide appropriate to welding robotic processes PPE, maintenance and operating procedures, LOTO hardware and procedures, to keep the equipment in clean conditions.