

LINCOLN ELECTRIC

# ROBOTIC HYPERFILL®

HIGHER DEPOSITION WELDS - FASTER. EASIER.

Designed to revolutionize heavy fabrication productivity, the patented HyperFill twin wire MIG solution allows for increased deposition rates without compromising puddle stability or weld quality. Utilizing a single power source, a single wire feeder, and a single tip, this innovative twin wire design delivers a wide, smooth arc cone that allows for deposition rates up to 25 lb/hr | 11.3 kg/hr without added system or programming complexity.



## PROCESS COMPARISON - 5/16 IN | 8 MM FILLET AT 18 LBS | 8.2 KG / HR

### Single Wire

E70C-6M .052 IN (1.32 MM)

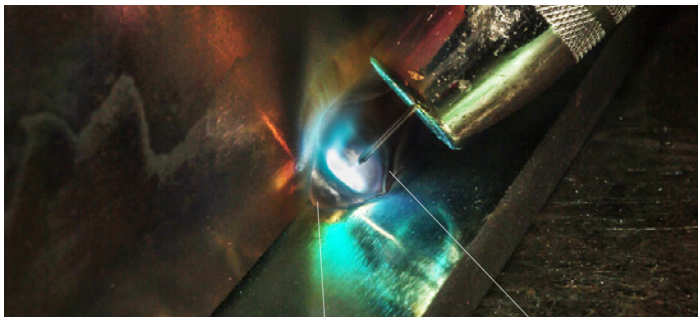

Generates a deep, narrow arc cone

Arc stability deteriorates at higher wire feed speeds making process more difficult to use

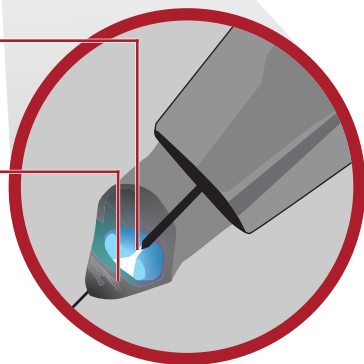

Narrow arc cone, narrow penetration profile. Increased risk of weld defects at higher deposition rates.

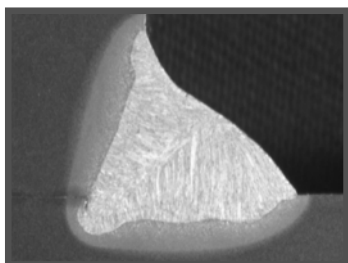

### HYPERFILL

SuperArc® .045 IN (1.0 MM)

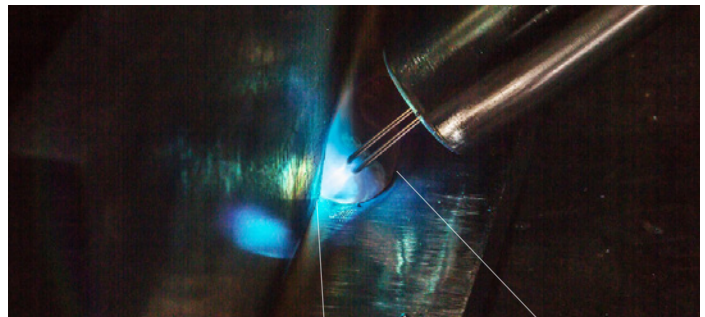

Generates a wide, evenly-distributed arc cone

vs. Smooth, stable puddle is more favorable and makes process easy to use at higher deposition rates

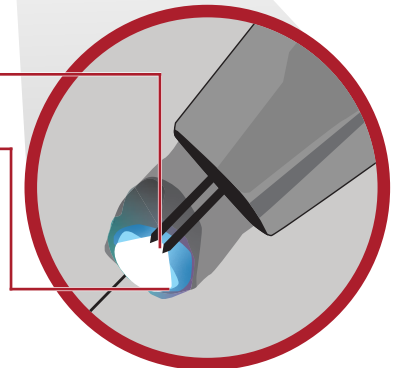

Wide arc cone leads to favorable, robust penetration profile and helps to improve weld quality at high deposition rates.

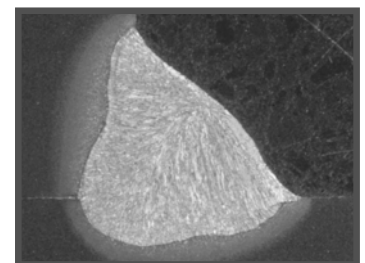

# PROCESS COMPARISON - DEPOSITION RANGE

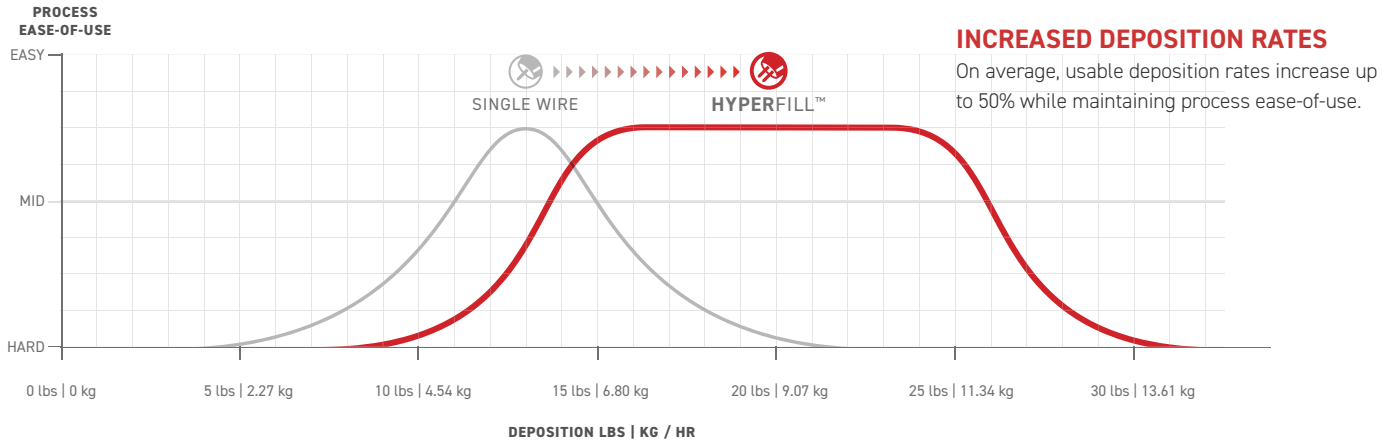

## PRODUCTIVITY INCREASE SINGLE WIRE VS. HYPERFILL

### BASELINE PARAMETERS

Single-wire at 13lbs/hr. (5.9 kg/hr)  
5/16 IN (8mm) 2F weld

3.28 ft (1m) weld distance  
13in/min (33cm/min) travel speed  
3 min. weld time

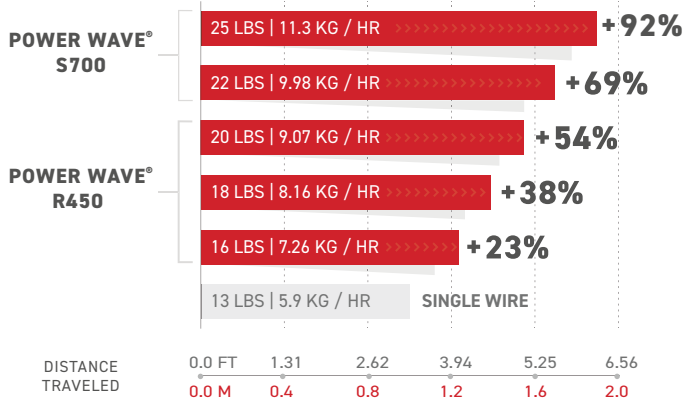

## ROBOTIC HYPERFILL CAPABILITIES

- Reamer** - The HyperFill solution uses typical I.D. nozzle sizes allowing for use of a standard reamer and ability to cleanly clip both wires.
- Though Arc Seam Tracking** - Seam tracking has been tested and can be effectively utilized in horizontal fillets and groove welds with FANUC®, ABB®, and Yaskawa®.
- TCP (Tool Center Point) Calibration** - FANUC® Torchmate and ABB® BullsEye have been tested and can be effectively utilized, regardless of wire orientation.
- Touch Sensing** - Refer to table below for touch sensing guidelines. For touch sensing critical applications, Laser based touch sensing is recommended.
- Robotic Torch** - HyperFill specific contact tips and diffusers are proprietary design and critical to the solution. They are to be used only with Lincoln Electric's Magnum® PRO 500A Water Cooled Robotic Torch.

## HYPERFILL & TOUCH SENSING CAPABILITIES

APPLICATION	SEAM TRACKING	TOUCH SENSING
TOUCH CRITICAL PARTS	-	LASER TOUCH
< 5/16 IN (8MM) FILLETS	DISABLED	LASER TOUCH
≥ 5/16 IN (8MM) FILLETS	DISABLED	LASER OR WIRE TOUCH
≥ 5/16 IN (8MM) FILLETS	ENABLED	LASER OR WIRE TOUCH

## SOLUTION COMPONENTS WITH ANY STANDARD OR CUSTOMIZED ROBOTIC SYSTEMS



**Power Source / Wirefeeder**  
Power Wave® R450 / S700  
AutoDrive® 4R220  
HyperFill™ Waveform



**Robotic Torch / Water Cooler**  
Magnum® PRO 500A Water Cooled Torch  
HyperFill™ Tip (Contact Tip, Diffuser)  
Cool Wave™ 20S



**Robotic Welding Cell**  
HyperFill® Fab-Pak®

### Test Results Disclaimer

Test results for mechanical properties, deposit, fume generation, or electrode composition and diffusible hydrogen levels were obtained from a weld produced and tested according to prescribed standards. Actual results will vary depending on many factors, including, but not limited to: the base material or substrate being welded, the welding procedure and welding process, and the unique conditions present in the workplace or welding environment. Users and employers have the sole responsibility for and control over workplace conditions, including the manner in which work is performed and the safety measures taken. Always read and follow applicable OSHA regulations as well as all information on product labeling and safety data sheets when using Lincoln Electric products. Safety data sheets for Lincoln Electric products can be found at <http://www.lincolnelectric.com/en-us/support/msds/Pages/sds-search.aspx>. Users and employers should have an industrial hygienist check worker exposure levels to be certain that they are within applicable OSHA PEL and ACGIH TLV limits for the particular application or weldment.

### HyperFill™ Waveform Activation Capability with Power Wave® and PIPEFAB™ Systems

Your purchase of a Lincoln Electric Power Wave welding system comes with (i) a license to use Lincoln Electric standard Power Wave waveforms, and (ii) HyperFill waveform capability, which requires a separate license. Without the separate license, the HyperFill waveform is not available for use on these machines, and only the standard Power Wave waveforms are usable.

For more information, please see the REVEAL/HyperFill Supplemental Terms and Conditions [here](#).

### Customer Assistance Policy

The business of The Lincoln Electric Company® is manufacturing and selling high quality welding equipment, consumables, and cutting equipment. Our challenge is to meet the needs of our customers and to exceed their expectations. On occasion, purchasers may ask Lincoln Electric for information or advice about their use of our products. Our employees respond to inquiries to the best of their ability based on information provided to them by the customers and the knowledge they may have concerning the application. Our employees, however, are not in a position to verify the information provided or to evaluate the engineering requirements for the particular weldment. Accordingly, Lincoln Electric does not warrant or guarantee or assume any liability with respect to such information or advice. Moreover, the provision of such information or advice does not create, expand, or alter any warranty on our products. Any express or implied warranty that might arise from the information or advice, including any implied warranty of merchantability or any warranty of fitness for any customers' particular purpose is specifically disclaimed.

Lincoln Electric is a responsive manufacturer, but the selection and use of specific products sold by Lincoln Electric is solely within the control of, and remains the sole responsibility of the customer. Many variables beyond the control of Lincoln Electric affect the results obtained in applying these types of fabrication methods and service requirements.