

CITOARC[®] 275

For use with machines having code numbers: 50539



SERVICE MANUAL



LINCOLN ELECTRIC EUROPE
www.lincolnelectric.eu

INDEX OF CONTENTS

INDEX OF CONTENTS	2
TECHNICAL SPECIFICATIONS.....	3
ELECTROMAGNETIC COMPATIBILITY (EMC).....	2
SAFETY	3
INTRODUCTION	5
INSTALLATION AND OPERATOR INSTRUCTIONS.....	5
MAINTENANCE	15
MAJOR COMPONENTS LOCATION	16
THEORY OF OPERATION	17
INPUT SECTION	18
INVERTER AND OUTPUT SECTIONS	19
CONTROL BOARD – TFT UI BOARD	20
TROUBLESHOOTING AND REPAIR SECTION	23
HOW TO USE TROUBLESHOOTING GUIDE	24
CASE COVER REMOVAL AND DC BUS CAPACITOR DISCHARGE PROCEDURE.....	27
CITOARC® 275 - SIDE PANELS REMOVAL	28
DC BUS CAPACITORS DISCHARGE PROCEDURE	29
EMI FILTER BOARD RESISTANCE TEST	30
INPUT RECTIFIER RESISTANCE TEST	32
INVERTER BOARD AND OUTPUT DIODES RESISTANCE TEST	34
THERMAL PROTECTION RESISTANCE TEST	37
OUTPUT STUDS RESISTANCE TEST	39
EMI FILTER BOARD VOLTAGE TEST.....	41
INPUT RECTIFIER VOLTAGE TEST	43
PRELOAD BOARD VOLTAGE TEST	45
AUX. POWER SUPPLY BOARD VOLTAGE TEST	47
INVERTER AND OUTPUT BOARD VOLTAGE TEST	49
CONTROL BOARD VOLTAGE TEST	51
DISASSEMBLY OPERATIONS.....	54
RETEST AFTER REPAIR	65
ELECTRICAL SCHEMATICS	66
ERROR CODES	67
NOTE.....	68

Technical Specifications

NAME		INDEX		
CITOARC 275		W100000003		
INPUT				
CITOARC 275	Input Voltage U_1		EMC Class	
	400V +/- 15% 3 phases		A	
	I_{1eff}		I_{1max}	
9.8A		15,3A		
RATED OUTPUT				
INVERTEC 275S	Input Power at Rated Cycle	Input Amperes I_{1max}	PF (400V)	
	7,1 kVA (@100%)	10,1A	0,79	
	9,1 kVA (@60%)	12,9A	0,85	
11 kVA (@25%)		15,3A	0,89	
RATED OUTPUT				
GTAW	Duty Cycle 40°C (based on a 10 min. period)		Output Current I_2	
	100%		200A	
	60%		230A	
SMAW	40%		270A	
	100%		180A	
	60%		230A	
25%		270A		
OUTPUT RANGE				
GTAW	Welding Current Range		Peak Open Circuit Voltage U_0	
	5 - 270A		70V	
SMAW	5 - 270A			
RECOMMENDED INPUT CABLE AND FUSE SIZES				
	Fuse Type gR or Circuit Breaker Type Z	Power Lead		
CITOARC 275	16A, 400V AC	4 Conductors, 1,5mm ²		
DIMENSIONS AND WEIGHT				
CITOARC 275	Weight	Height	Width	Length
	14,1Kg	360 mm	230 mm	498 mm
PROTECTION RATING AND TEMPERATURE				
CITOARC 275	Protection Rating		Maximum Gas Pressure	
	IP23		0,5 MPa (5 bar)	
CITOARC 275	Operating Temperature		Storage Temperature	
	from -10°C to +40°C		from -25°C to +55°C	

Electromagnetic Compatibility (EMC)

01/11

This machine has been designed in accordance with all relevant directives and standards. However, it may still generate electromagnetic disturbances that can affect other systems like telecommunications (telephone, radio, and television) or other safety systems. These disturbances can cause safety problems in the affected systems. Read and understand this section to eliminate or reduce the amount of electromagnetic disturbance generated by this machine.



This machine has been designed to operate in an industrial area. To operate in a domestic area it is necessary to observe particular precautions to eliminate possible electromagnetic disturbances. The operator must install and operate this equipment as described in this manual. If any electromagnetic disturbances are detected the operator must put in place corrective actions to eliminate these disturbances, if necessary with assistance from

Lincoln Electric.

WARNING

Provided that the public low voltage system impedance at the point of common coupling is lower than:

- 64,8mΩ for the **CITOARC 275**

This equipment is compliant with IEC 61000-3-11 and IEC 61000-3-12 and can be connected to public low voltage systems. It is the responsibility of the installer or user of the equipment to ensure, by consultation with the distribution network operator if necessary, that the system impedance complies with the impedance restrictions.

Before installing the machine, the operator must check the work area for any devices that may malfunction because of electromagnetic disturbances. Consider the following.

Input and output cables, control cables, and telephone cables that are in or adjacent to the work area and the machine.

Radio and/or television transmitters and receivers. Computers or computer controlled equipment.

Safety and control equipment for industrial processes. Equipment for calibration and measurement.

Personal medical devices like pacemakers and hearing aids.

Check the electromagnetic immunity for equipment operating in or near the work area. The operator must be sure that all equipment in the area is compatible. This may require additional protection measures.

The dimensions of the work area to consider will depend on the construction of the area and other activities that are taking place.

Consider the following guidelines to reduce electromagnetic emissions from the machine.

Connect the machine to the input supply according to this manual. If disturbances occur it may be necessary to take additional precautions such as filtering the input supply.

The output cables should be as short as possible and positioned together as close as possible to each other. If possible connect the work piece to ground in order to reduce the electromagnetic emissions. The operator must check that connecting the work piece to ground does not cause problems or unsafe operating conditions for personnel and equipment.

Shielding of cables in the work area can reduce electromagnetic emissions. This may be necessary for special applications.

WARNING

EMC classification of this product is class A in accordance with electromagnetic compatibility standard EN 60974-10 which means that the product is designed to be used in an industrial environment only.

WARNING











The Class A equipment is not intended for use in residential locations where the electrical power is provided by the public low-voltage supply system. There may be potential difficulties in ensuring electromagnetic compatibility in those locations, due to conducted as well as radiated disturbances.









WARNING

This equipment have to be used by qualified personnel. Be sure that all installation, operation, maintenance and repair procedures are performed only by qualified person. Read and understand this manual before operating this equipment. Failure to follow the instructions in this manual could cause serious personal injury, loss of life, or equipment damage. Read and understand the following explanations of the warning symbols. Lincoln Electric is not responsible for damages caused by improper installation, improper care or abnormal operation.

	<p>WARNING: This symbol indicates that instructions must be followed to avoid serious personal injury, loss of life, or equipment damage. Protect yourself and others from possible serious injury or death.</p>
	<p>READ AND UNDERSTAND INSTRUCTIONS: Read and understand this manual before operating this equipment. Arc welding can be hazardous. Failure to follow the instructions in this manual could cause serious personal injury, loss of life, or equipment damage.</p>
	<p>ELECTRIC SHOCK CAN KILL: Welding equipment generates high voltages. Do not touch the electrode, work clamp, or connected work pieces when this equipment is turned on. Insulate yourself from the electrode, work clamp, and connected work pieces.</p>
	<p>ELECTRICALLY POWERED EQUIPMENT: Turn off the input power using the disconnect switch at the fuse box before working on this equipment. Ground this equipment in accordance with local electrical regulations.</p>
	<p>ELECTRICALLY POWERED EQUIPMENT: Regularly inspect the input, electrode, and work clamp cables. If any insulation damage exists replace the cable immediately. Do not place the electrode holder directly on the welding table or any other surface in contact with the work clamp to avoid the risk of accidental arc ignition.</p>
	<p>ELECTROMAGNETIC FIELD MAY BE DANGEROUS: Electric current flowing through any conductor creates electromagnetic field (EMF). EMF fields may interfere with some pacemakers, and welders having a pacemaker shall consult their physician before operating this equipment.</p>
	<p>CE COMPLIANCE: This equipment complies with the European Community Directives.</p>
 <p><small>Optical radiation emission Category 2 (EN 12195)</small></p>	<p>ARTIFICIAL OPTICAL RADIATION: According with the requirements in 2006/25/EC Directive and EN 12198 Standard, the equipment is a category 2. It makes mandatory the adoption of Personal Protective Equipment (PPE) having filter with a protection degree up to a maximum of 15, as required by EN169 Standard.</p>
	<p>FUMES AND GASES CAN BE DANGEROUS: Welding may produce fumes and gases hazardous to health. Avoid breathing these fumes and gases. To avoid these dangers the operator must use enough ventilation or exhaust to keep fumes and gases away from the breathing zone.</p>
	<p>ARC RAYS CAN BURN: Use a shield with the proper filter and cover plates to protect your eyes from sparks and the rays of the arc when welding or observing. To protect the skin, use suitable clothing made of durable, fireproof material. Protect other nearby personnel with suitable, non-flammable screening and warn them not to watch the arc nor expose themselves to the arc.</p>

	<p>WELDING SPARKS CAN CAUSE FIRE OR EXPLOSION: Remove fire hazards from the welding area and have a fire extinguisher easily accessible. Welding sparks and hot materials from the welding process can easily go through small cracks and openings to adjacent areas. Do not weld on any tanks, drums, containers, or material until the proper steps have been taken to insure that no flammable or toxic vapors will be present. Never use this equipment when flammable gases, vapors or flammable liquids are present.</p>
	<p>WELDED MATERIALS CAN BURN: Welding generates a large amount of heat. Hot surfaces and materials in work area can cause serious burns. Use gloves and pliers when touching or moving materials in the work area.</p>
	<p>CYLINDER MAY EXPLODE IF DAMAGED: Use only certificate, compressed gas cylinders containing the correct shielding gas for the process used and properly operating regulators designed for the gas and pressure used. Always keep cylinders in an upright position securely chained to a fixed support. Do not move or transport gas cylinders with the protection cap removed. Do not allow the electrode, electrode holder, work clamp or any other electrically live part to touch a gas cylinder. Gas cylinders must be located away from areas where they may be subjected to physical damage or the welding process including sparks and heat sources.</p>
	<p>MOVING PARTS ARE DANGEROUS: There are moving mechanical parts in this machine, which can cause serious injury. Keep your hands, body and clothing away from those parts during machine starting, operating and servicing.</p>
	<p>SAFETY MARK: This equipment is suitable for supplying power for welding operations carried out in an environment with increased risk of electric shock.</p>

The manufacturer reserves the right to make changes and/or improvements in design without upgrade at the same time the operator's manual.

Introduction

CITOARC 275 is a SMAW and GTAW power source.

Recommended equipment, which can be bought by user, was mentioned in the "Accessories" chapter.

The complete package contains:
Power source
USB with operator's manual

Installation and Operator Instructions

Read this entire section before installation or operating the machine.

Exploitation conditions

This machine can operate in harsh environments. However, it is important to use the following simple preventive measures that will ensure its long life and reliable operation:

Do not place or operate this machine on a surface with an incline higher than 15° from horizontal.

Do not use this machine for pipe thawing.

This machine must be located where there is free circulation of clean air without restrictions for air movement. Do not cover the machine with paper, cloth or rags when switched on.

Dirt and dust that can be drawn into the machine should be kept to a minimum.

This machine has a protection rating of IP23. Keep it dry when possible and do not place it on wet ground or in puddles.

Locate the machine away from radio controlled machinery. Normal operation may adversely affect the operation of nearby radio controlled machinery, which may result in injury or equipment damage. Read the section on electromagnetic compatibility in this manual.

Do not operate in areas with an ambient temperature greater than 40°C.

Duty cycle and Overheating

The duty cycle of a welding machine is the percentage of time in a 10 minute cycle at which the welder can operate the machine at rated welding current.

Example: 60% duty cycle:

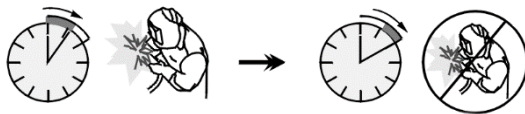

Welding for 6 minutes.

Break for 4 minutes.

Excessive extension of the duty cycle will cause the thermal protection circuit to activate.

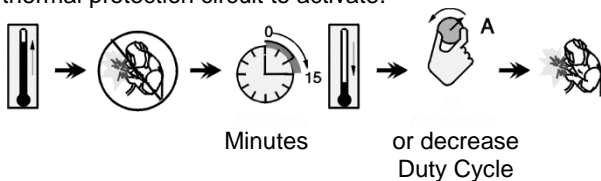

Minutes

or decrease
Duty Cycle

Input Supply Connection

WARNING

Only a qualified electrician can connect the welding machine to the supply network. Installation had to be made in accordance with the appropriate National Electrical Code and local regulations.

Check the input voltage, phase and frequency supplied to this machine before turning it on. Verify the connection of ground wires from the machine to the input source. The welding machine **CITOARC 275** must be connected to a correctly installed plug-in socket with an earth pin. Input voltage is 400 Vac 50/60Hz. For more information about input supply refer to the technical specification section of this manual and to the rating plate of the machine.

Make sure that the amount of mains power available from the input supply is adequate for normal operation of the machine. The necessary delayed fuse or circuit breaker and cable sizes are indicated in the technical specification section of this manual.

WARNING

The welding machine can be supplied from a power generator of output power at least 30% larger than input power of the welding machine.

WARNING

When powering the machine from a generator be sure to turn off welder first, before generator is shut down, in order to prevent damage to welder!

Controls and Operational Features

Front panel CITOARC 275

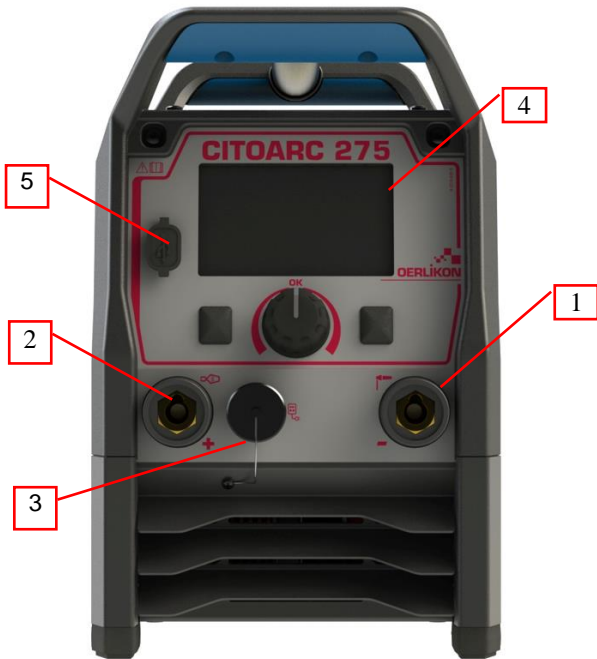

Figure 1

1. Output negative socket for the welding circuit
2. Output positive socket for the welding circuit: Socket where TIG torch must be connected
3. Remote Control Connector Plug For connecting a Remote Control Kit
4. User Interface: See „User Interface” section.
5. USB connector

Back panel CITOARC



Figure 2

1. Power switch

User Interface



Figure 3

1. Display: 5” TFT display shows welding processes parameters.
2. Left button: Home & Back
3. Central Knob: Parameter access and validation by pushing knob
4. Right Button: Access to specific parameter of the current selected page.

Main Menu

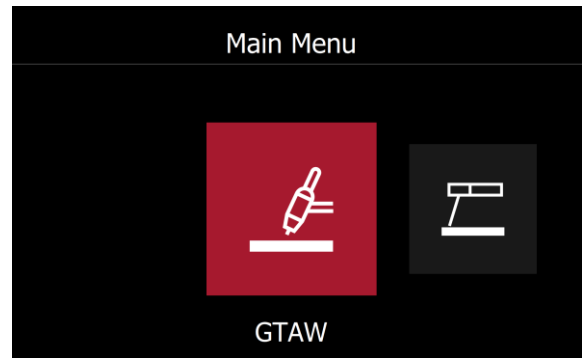

Figure 4

In Main Menu, 3 selections are possible

- GTAW: allow to enter in TIG Home Menu
- SMAW: allow to enter in MMA Home Menu
- Information: Entering in this section allow to the user to configure various parameters of the power source.

Home Menu description

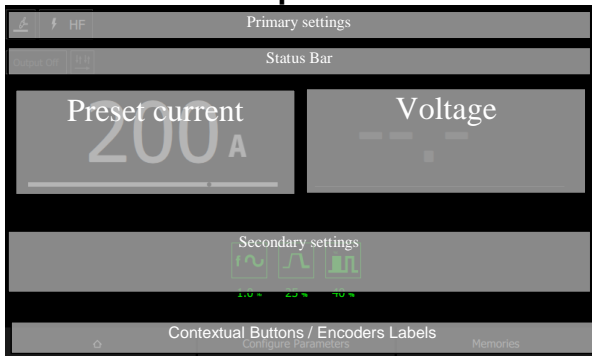

Figure 5

1. In “Primary Settings” area, the type of process and corresponding information will be indicated like type of arc striking for TIG and type of MMA mode (Soft, Crisp etc ...)

If “Guided Setup Mode” is selected, all inputs will be displayed in the section.

2. “Status Bar” give additional information like Trigger Interlock selection, remote control status.
3. “Preset Current” indicates the current value configured by welder and, during welding, welding current value.
4. “Voltage”: Indication of voltage welding voltage.
5. “Secondary Settings” allow to user to see the current values of weld sequence parameters.
6. “Contextual Buttons / Encoders Labels”, informs the user of features associated to the knob and buttons

Welding GTAW process

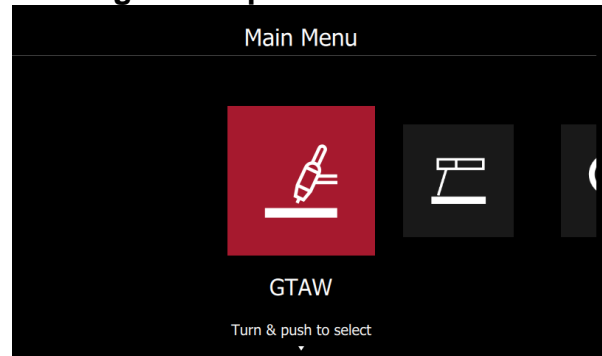

To select, TIG mode process, select the GTAW icon and push the knob button. Only Touch start.

Home menu

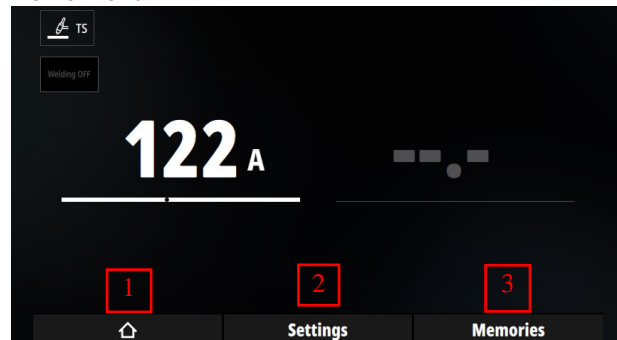

Figure 6

1. “Main Menu” access, push this button to go back.
2. Push button to configure all parameters of current process. Turn the knob to adjust the welding current value.
3. “Memories” access. See "Memories" subchapter.

Configure Parameters

Weld sequence

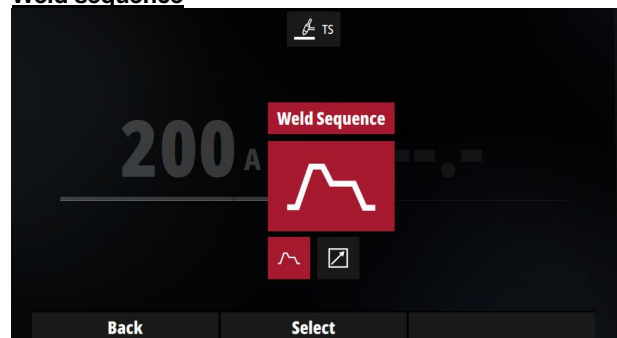

Figure 7

Select “Weld Sequence” menu to configure the following parameters:

- Start current
- Ramp-up time
- Welding current

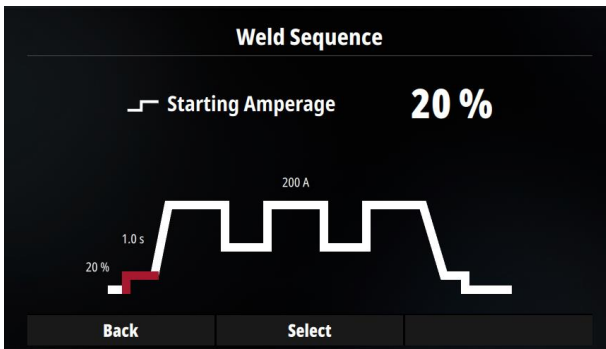

Figure 8

For each parameters, use the knob to reach corresponding part of the weld sequence and push knob button to set value.

Remote control

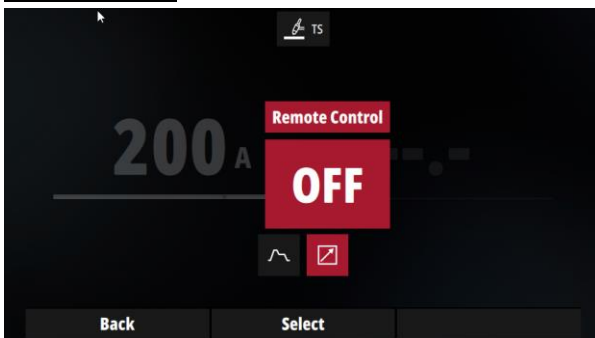

Figure 9

In GTAW mode, 2 accessories can be selected:

- Hand remote control
- Pedal Remote control.

See "Accessories" subchapter for more details.

Welding SMAW process

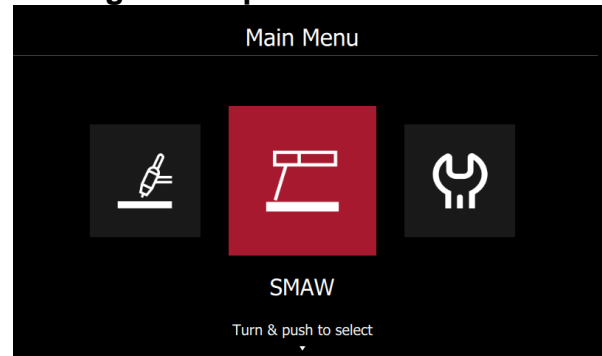

Figure 10

To select, stick mode process, select the SMAW icon and push the knob button.

Home menu

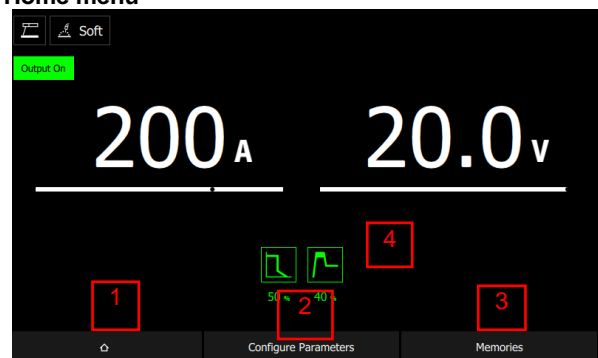

Figure 11

1. "Main Menu" access, push this button to go back to "Main Menu".
2. Push button to configure all parameter of current process. Turn the knob to adjust the welding current value.
3. "Memories" access. See dedicated section.
4. "Secondary settings" User can see directly on "Home page" the current parameter values.

Configure Parameters

Stick modes

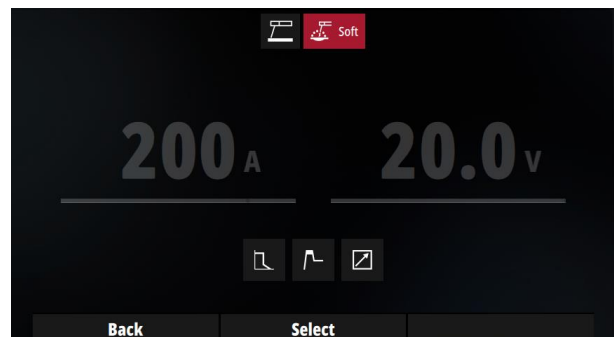

Figure 12

To change the Stick modes, select the corresponding menu and push the Knob button.

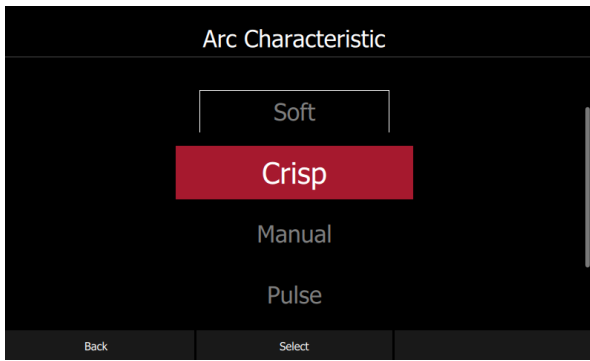

Figure 13

The machine allow the user the use 4 stick mode:

- Soft: For a welding with a low spatter presence. Hot Start and Arc Force are pre-defined and can not be modified
- Crisp: For an aggressive welding, with an increased Arc stability.
- Manual: user has full control of Arc Force and Hot start parameters.
- Pulse: user can define the frequency, duty, and welding current.

Hot Start

This is a temporary increase in the initial welding current. This helps ignite the arc quickly and reliably.

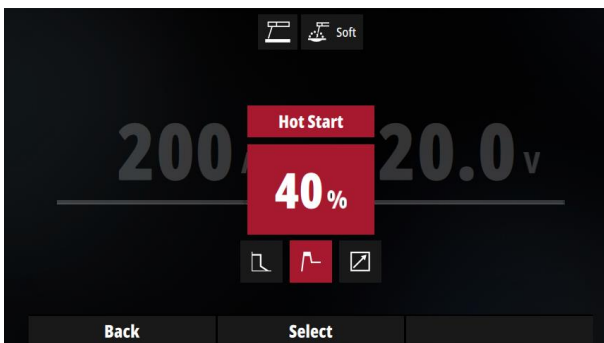

Figure 14

Select the "Hot Start", push the knob button, change the value and push again to validate.

Unit is in percentage. In this example the Initial current will be equal the welding current with 40% of welding current added.

Example: if welding current is 100A, the Hot Start current will be 40%

Arc Force

This is a temporary increase in the output current during normal stick welding. This temporary increase in output current is used to clear intermittent connections between the electrode and the weld puddle that occur during normal stick welding.

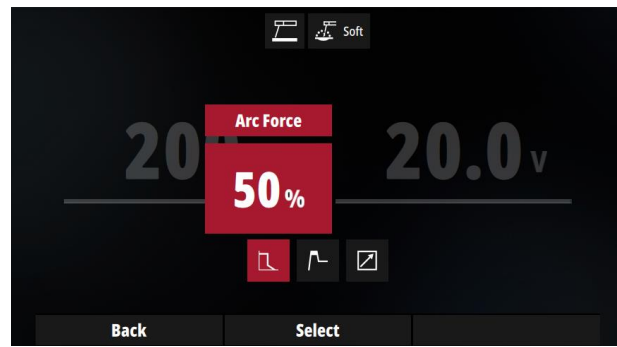

Figure 15

Anti-Sticking

This feature cannot be modified by user.

This is a function that decreases the output current of the machine to a low level when the operator makes an error and sticks the electrode to the work piece. This decrease in current allows the operator to remove the electrode from the electrode holder without creating large sparks that can damage the electrode holder.

Remote Control

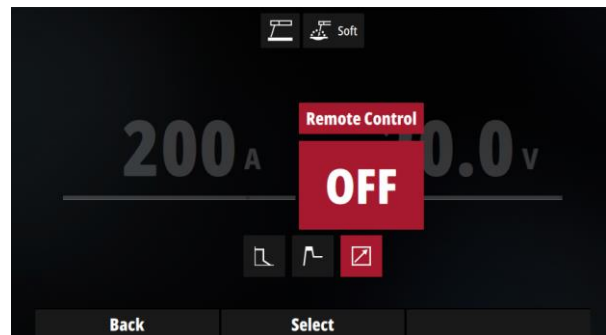

Figure 16

In SMAW mode, 2 accessories can be selected:
Hand remote control
Pedal Remote control.

See "Accessories" subchapter for more details.

Accessories

Accessories can be accessed in GTAW and SMAW by pushing knob button and selecting “Remote Control” icon and push knob again.

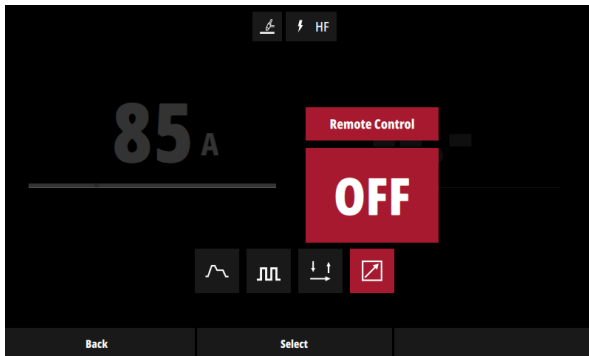

Figure 17

When activated, a new icon appears on the right of “Remote Control” icon named “Remote range”.

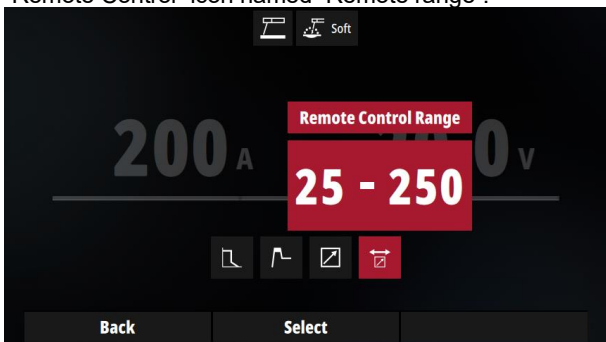

Figure 18

Hand Remote

Usable for GTAW and SMAW process.

The current displayed correspond to the position of the remote control potentiometer from minimum to maximum current.

Minimum and maximum can be defined in the “Remote Range”. In above example, the minimum current is 25A and the maximum is 250A.

Foot Pedal

Usable in GTAW only.

When selected, the maximum current is the one set on “Home” page by the knob. The minimum current is, like “Hand Remote”, the one set on Remote Range section.

As much the pedal is pushed, as much the current will increase.

When Remote Control is activated, an icon is displayed on Home page

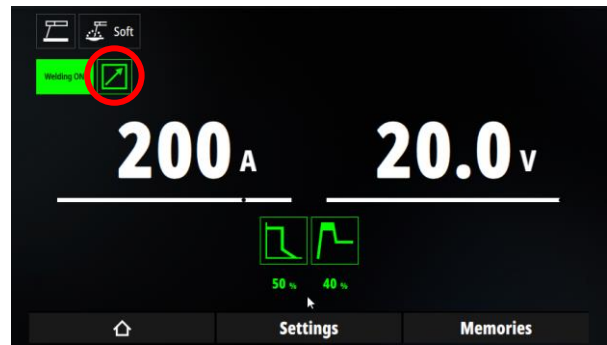

Figure 19

Memories

Welding process and all parameters which belongs to cycle can be saved in a memory slot in order to be recalled after.

“Memories” menu is accessible for both process TIG and Stick process from “Home menu”.

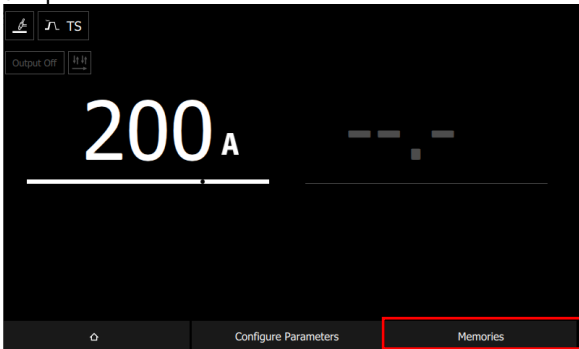

Figure 20

Push the right button to access to memories menu.

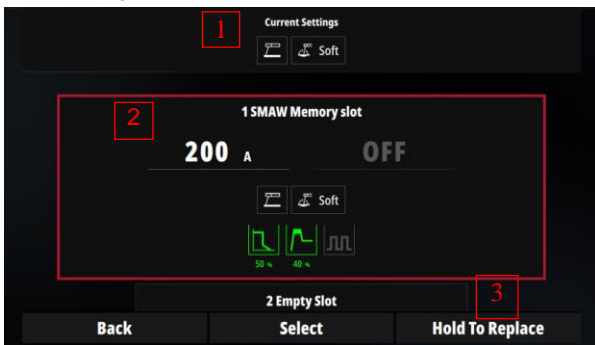

Figure 21

2. On the top of memory page, the current settings which are going to be saved are displayed.

With the knob it is possible to scroll up or down to select an empty or used slot memory. If the slot is already used, the parameters associated to the backup are displayed.

Push the knob button to recall the process and corresponding parameters stored in the selected slot.

In order to save the current setting in memory, push the right button and keep it hold until the end of saving.

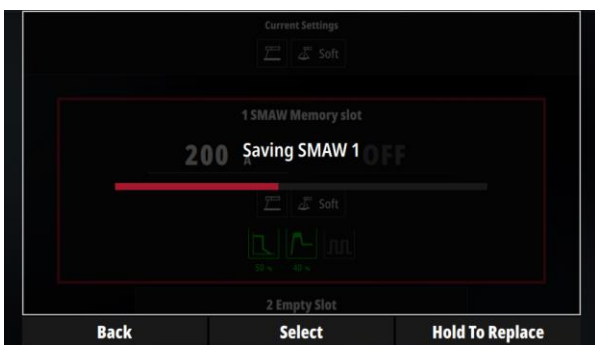

Figure 22

If button is released before the end of saving process, slot will not be erased.

Guided Setup

Guide Setup is a feature for SMAW which configures automatically the power source according to a set of input data:

Type of metal sheet.

Type of electrode.

Electrode diameter;

Based on this data, the power source will be automatically configured to get the most suitable parameter for the configuration.

Guide Setup activation

Guided Setup can be activated in “System Option” then “Weld Mode Setup”.

In “Manual Mode”, assistance is deactivated. A push on knob button will allow to activate it



Guide Setup use

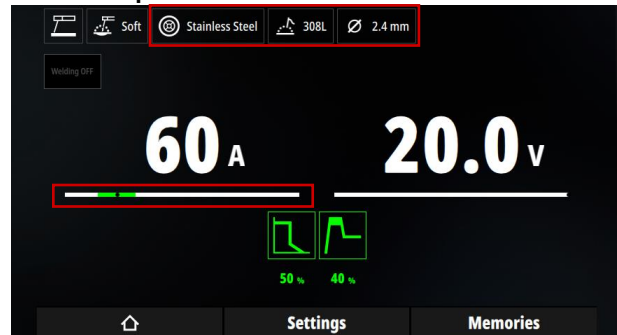

When Guided mode is activated, Home page will be adjusted by:

Adding list of all inputs data in “Primary Settings” section.

Preset a defined current value.

Modifying current range ribbon

Primary settings:

To change and configure input parameters press the knob button and navigate to parameter desired. Then push knob button to validate.

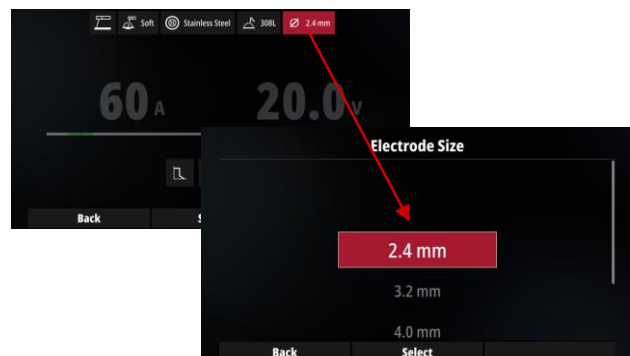

Once parameters are modified, the output welding current will be automatically adjust to fit with the application.

Current range ribbon

The machine automatically configures the best current value. It is also possible to adjust the current around this value. As soon as the current remains in proper welding current range for the application,



If the current exceed the proposer welding range, the ribbon turned into red indicating to the user the current selectin is not the best one.



System Options

To configure Power Source parameters, select “System Option” icon.

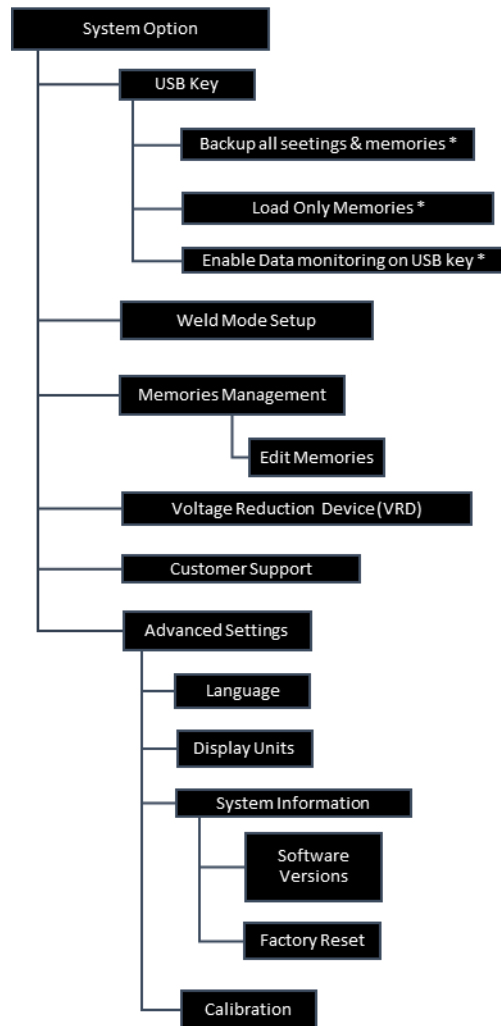
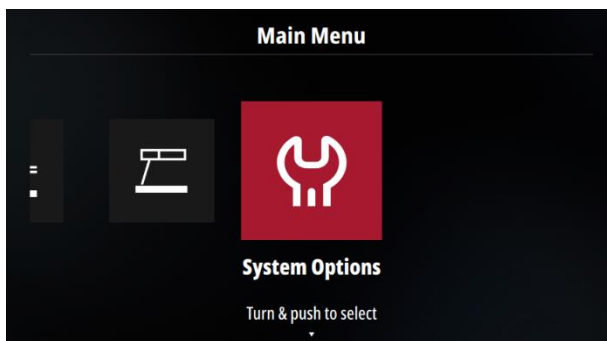

* Only available when USB key is plugged

USB Key → Backup all settings & memories

Export from power source to memories previously saved.

USB Key → Load Only Memories

Import from USB key to power source memories previously saved.

USB Key → Enable Data Monitoring on USB key

Activation of Data Monitoring is possible only when USB key is plugged.

A .csv file is created on USB where average voltage, average current, arc time and process selected.

Data monitoring remains active even if USB key is unplug and data will be store after plugging again USB key.

Weld Mode Setup

See “Guided Setup” section.

Memories Management

Saved memories can be deleted in this section.

Voltage Reduction Device

When activated, output voltage no load voltage will be reduced to 11V.

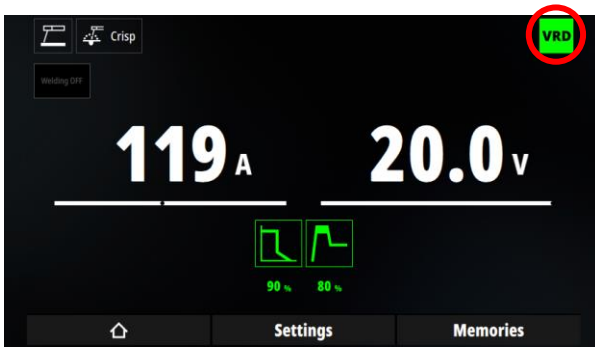

In SMAW page, icon  will appear on top right screen

Customer Support

In this menu, the user will find all accessories, spares parts and component linked to 275S.

Advanced Settings → System Information.

The software revision are displayed in this section.

Factory Reset allows to reset the power source parameters.

Calibration



WARNING

Calibration must be done by authorized technician with proper equipment: power load, multimeters

This section allows to calibration current and voltage of power source.

Software upgrade.

Software will be released during the life time of power source and bring new features.

In order to upgrade software, insert USB key formatted in FAT32 with new software package at the root of USB key.

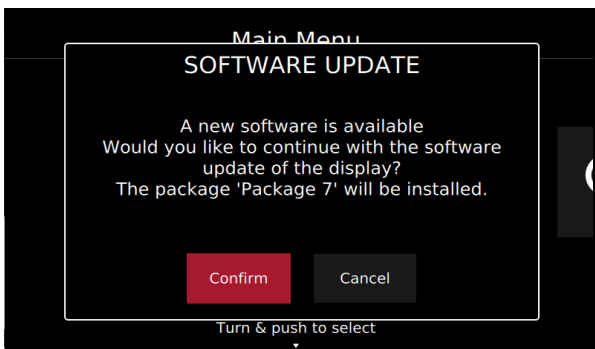

A second window will ask you to accept the installation of new software. Push "Confirm" button to start installation workflow.

Transport and Lifting



WARNING

Falling equipment can cause injury and damage to unit.

During transportation and lifting with a crane, adhere to the following rules:

The device contains elements adapted for transport. For lifting a suitable lifting equipment capacity.

WARNING

In any way the power source cannot be lifted

Maintenance

WARNING

For any repair operations, modifications or maintenances, it is recommended to contact the nearest Technical Service Center or Lincoln Electric. Repairs and modifications performed by unauthorized service or personnel will cause, that the manufacturer's warranty will be lost.

Any noticeable damage should be reported immediately and repaired.

Routine maintenance (everyday)

Check condition of insulation and connections of the work leads and insulation of power lead. If any insulation damage exists replace the lead immediately.

Remove the spatters from the welding gun nozzle. Spatters could interfere with the shielding gas flow to the arc.

Check the welding gun condition: replace it, if necessary. Check condition and operation of the cooling fan. Keep clean its airflow slots.

Periodic maintenance (every 200 working hours but at least once a year)

Perform the routine maintenance and, in addition: Keep the machine clean. Using a dry (and low pressure) airflow, remove the dust from the external case and from the cabinet inside.

If it is required, clean and tighten all weld terminals.

The frequency of the maintenance operations may vary in accordance with the working environment where the machine is placed.

WARNING

Do not touch electrically live parts.

WARNING

Before removed case, machine has to be turned off and the power lead has to be disconnected from mains socket.

WARNING

Mains supply network must be disconnected from the machine before each maintenance and service. After each repair, perform proper tests to ensure safety.

Customer Assistance Policy

The business of The Lincoln Electric Company is manufacturing and selling high quality welding equipment, consumables, and cutting equipment. Our challenge is to meet the needs of our customers and to exceed their expectations. On occasion, purchasers may ask Lincoln Electric for advice or information about their use of our products. We respond to our customers based on the best information in our possession at that time. Lincoln Electric is not in a position to warrant or guarantee such advice, and assumes no liability, with respect to such information or advice. We expressly disclaim any warranty of any kind, including any warranty of fitness for any customer's particular purpose, with respect to such information or advice. As a matter of practical consideration, we also cannot assume any responsibility for updating or correcting any such information or advice once it has been given, nor does the provision of information or advice create, expand or alter any warranty with respect to the sale of our products

Lincoln Electric is a responsive manufacturer, but the selection and use of specific products sold by Lincoln Electric is solely within the control of, and remains the sole responsibility of the customer. Many variables beyond the control of Lincoln Electric affect the results obtained in applying these types of fabrication methods and service requirements.

Subject to Change – This information is accurate to the best of our knowledge at the time of printing. Please refer to www.oerlikon-welding.com for any updated information.

Error Codes and troubleshooting

When the error occurs and remains, the Error messages is displayed in Red.

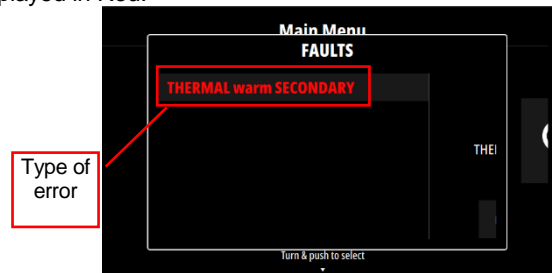

By pushing the knob button, the Error code number is displayed.

During error, new welding sequence is blocked until the reason of error remains.

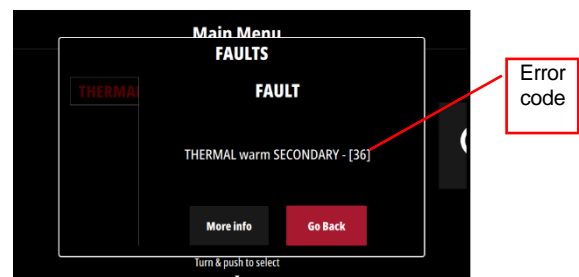

When the error vanished, it is now possible to acknowledge the error by pushing the knob. The background error message becomes white

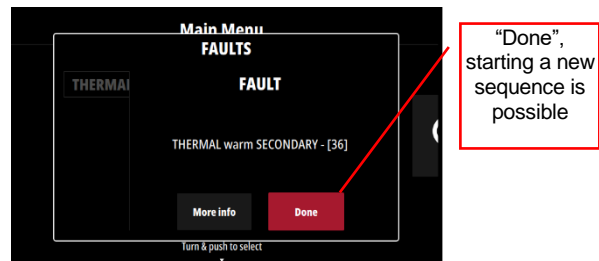

Table 1 shows list of basic errors that can appear. To get full list of error codes, please contact Lincoln Electric service.

MAINTENANCE

WARNING



ELECTRIC SHOCK can kill

Have an electrician install and service this equipment
Turn the input power off at the fuse box before working on equipment

Do not touch electrically hot parts

Prior to performing preventive maintenance, perform the following capacitor discharge procedure to avoid electric shock.

DC BUS CAPACITORS DISCHARGE PROCEDURE

1. Remove input power to the CITOARC® 275
2. Remove the side panels following the instruction available in this Service Manual.
3. Obtain a high resistance and high wattage resistor (25-1000 ohms and 25 watts minimum). This resistor is NOT supplied with the machine. NEVER USE A SHORTING STRAP FOR THIS PROCEDURE.
4. Locate the two terminals **DC+** and **DC -** on the Inverter Board on the left side of the machine (**See Figure 1**).
5. Use electrically insulate gloves and insulated pliers. Hold the body of the resistor and connect the resistor leads across the two terminals. Hold the resistor in place for 10 seconds. DO NOT TOUCH CAPACITOR TERMINALS WITH YOUR BARE HANDS.
6. Check the voltage across the two terminals. Voltage should be zero. If any voltage remains, repeat this procedure.

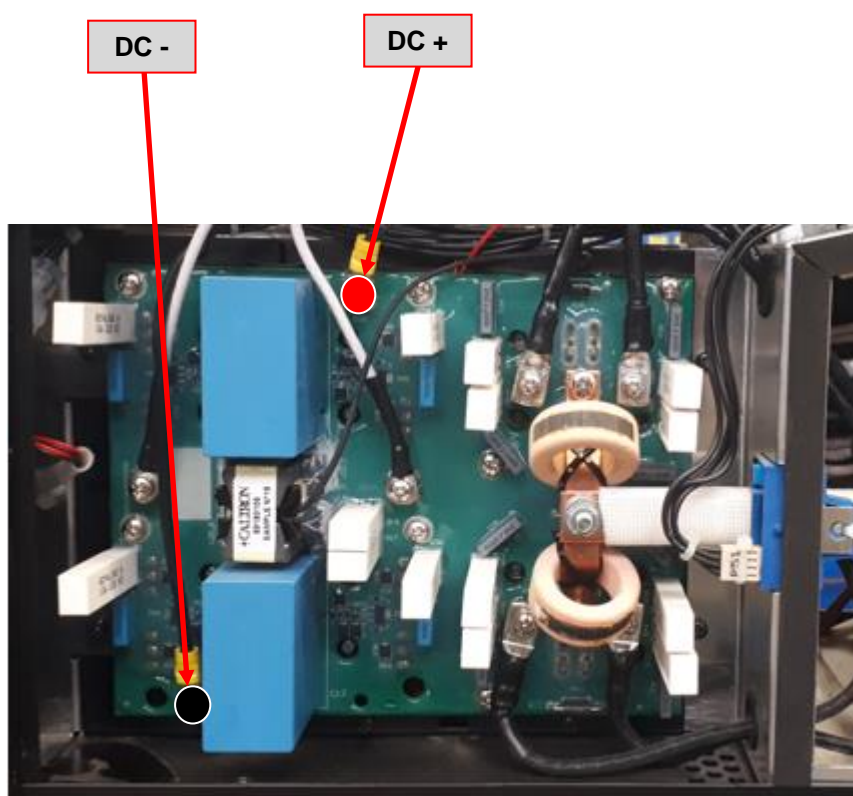
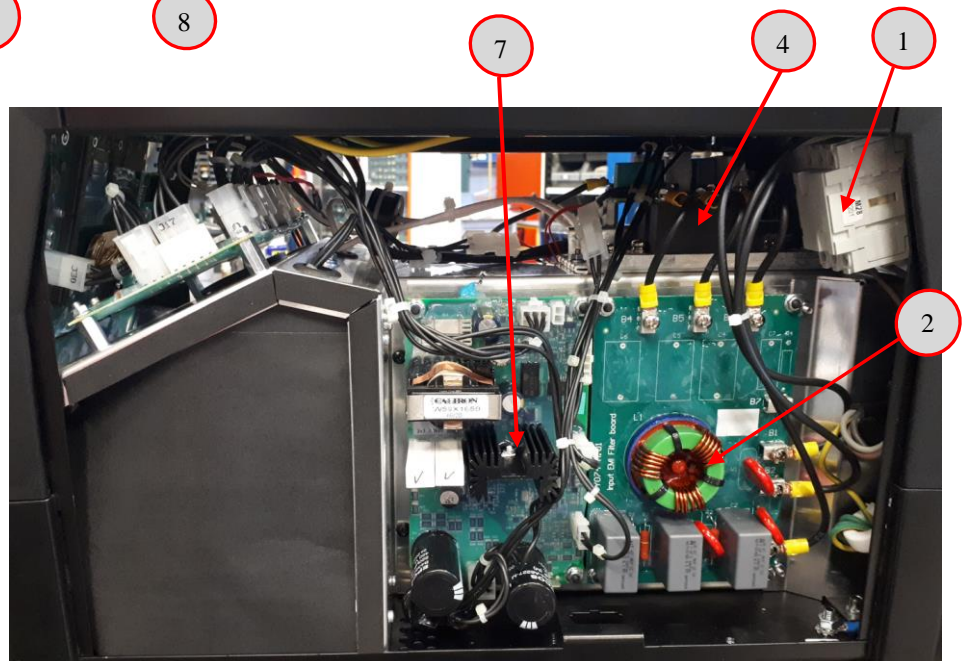
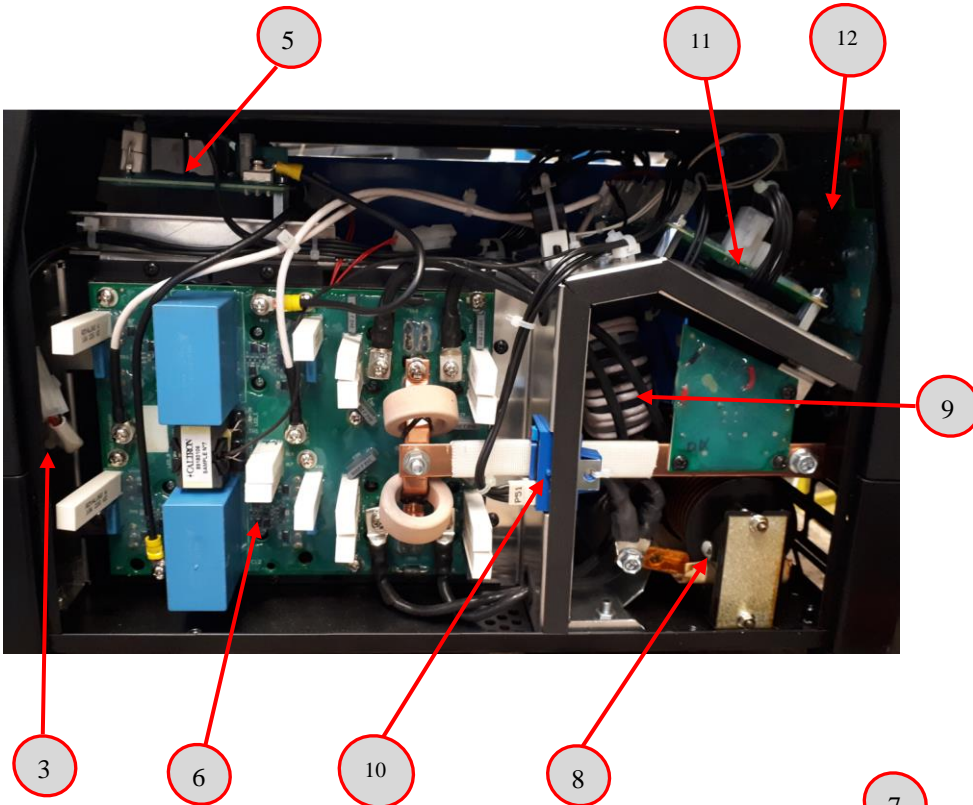

Figure 1
Showing machine left side

MAJOR COMPONENTS LOCATION

CITOARC[®] 275

1. Main Switch (S1)
2. EMC Filter Board
3. Fans
4. Input Rectifier
5. Preload PCB
6. Inverter
7. Aux. Power Supply Board
8. Output Choke
9. Output Transformer (T2)
10. Output Current Transducer
11. Control Board
12. TFT UI Board



THEORY OF OPERATION

CITOARC® 275 – WIRING DIAGRAM

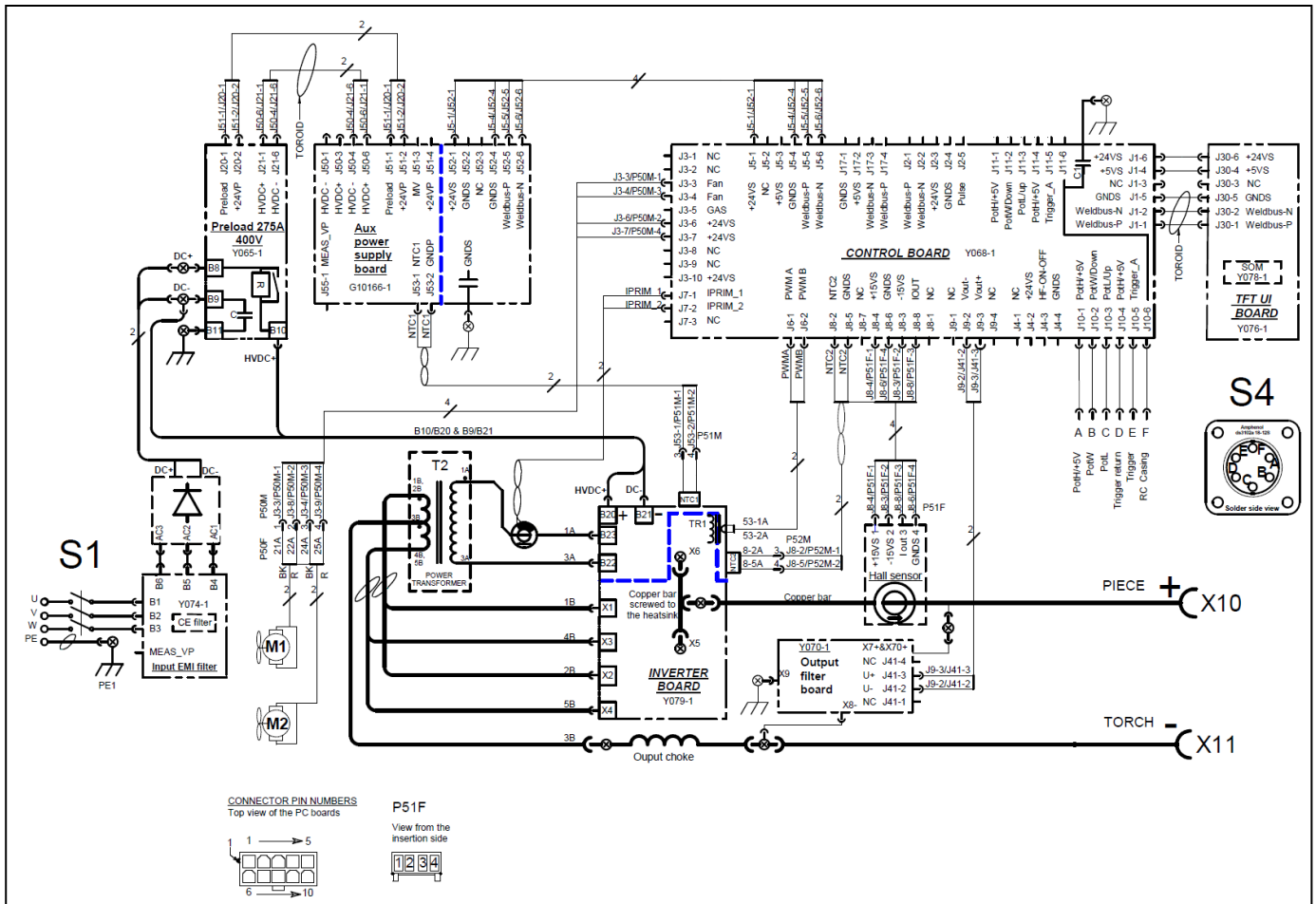

GENERAL DESCRIPTION

The CITOARC® 275 is an inverter based welding power source that offer multi-mode (STICK and LIFT TIG) constant current welding. The machines operates on three phases input voltage 400Vac. The welding response of this machine is optimized for the stick (SMAW) welding processes.

Thanks to their IP23 rating and potted boards this power source can be used in both factory or field operations.

Water Cooler is available as an option and has to be installed on the bottom of the machine.

INPUT SECTION

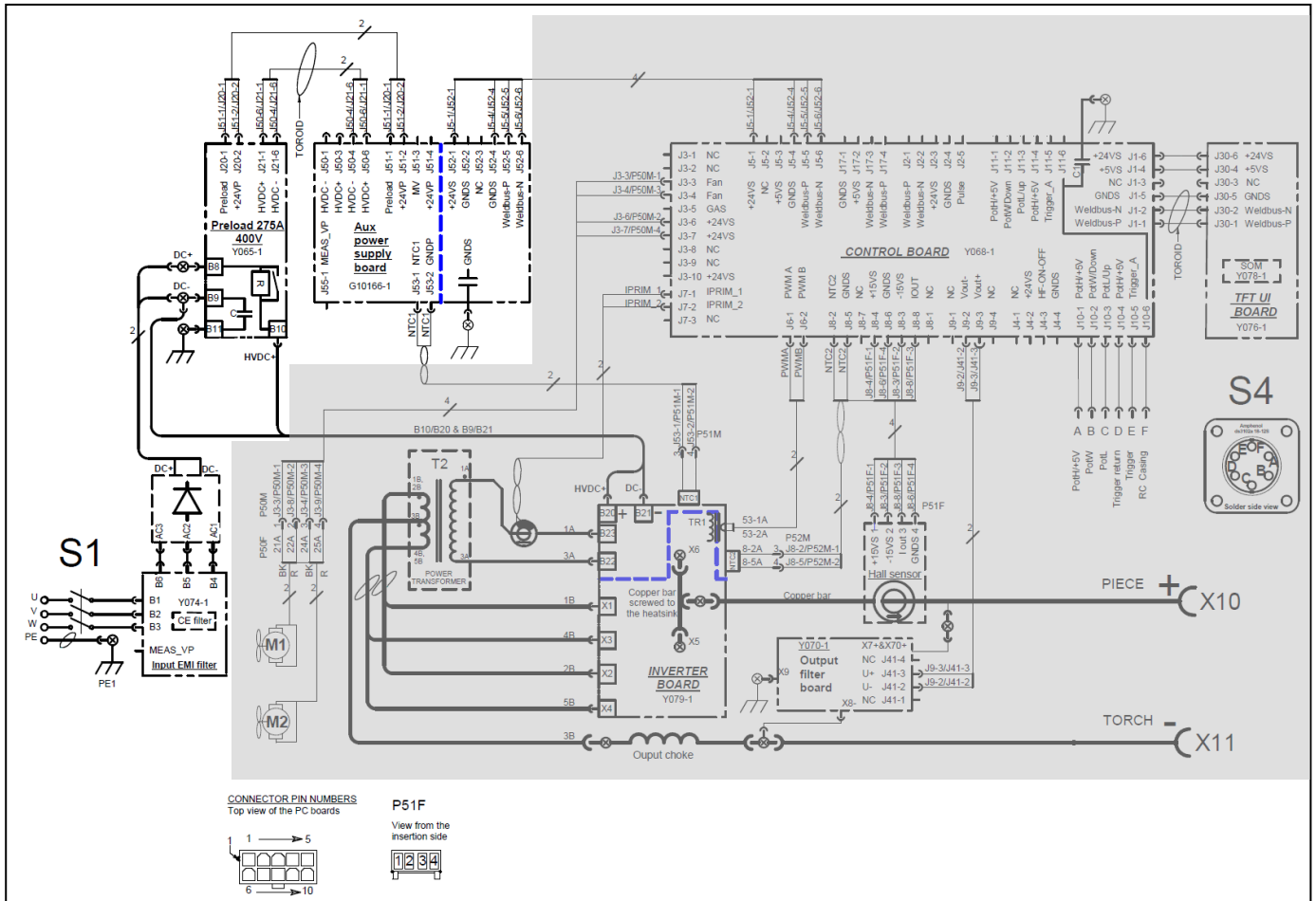

INPUT SECTION

When the three phase input voltage 400Vac is applied to the CITOARC® 275 and the input switch S1 is closed the voltage is applied to the Input EMI filter board.

EMI filter circuit prevents noise from the machine from being transmitted along the main power line and vice versa, necessary to be in accordance with all relevant directives and standards.

The three phases coming out from the EMI filter board are rectified by the input rectifier bridge and the resultant 565VDC voltage is applied to the Preload board.

The DC BUS voltage is reaching also the Aux. Power Board. The software loaded into the Aux. Power board

monitors the input voltage and if all is correct provides the command to the relay on the Preload board to close bypassing the start resistors.

During this time the DC BUS capacitors on the Inverter board started to charge through the 4 resistors located on the Preload board. Once the relay on the Preload board closes the DC BUS capacitors on inverter board complete their charge.

The Aux. Power Supply board provides all the insulated lower power supply needed by the machine's PCBs including the insulated 24Vdc needed to supply the Control Board. It receives also the signal from the NTC1 located on the primary power circuit of the inverter board.

INVERTER AND OUTPUT SECTIONS

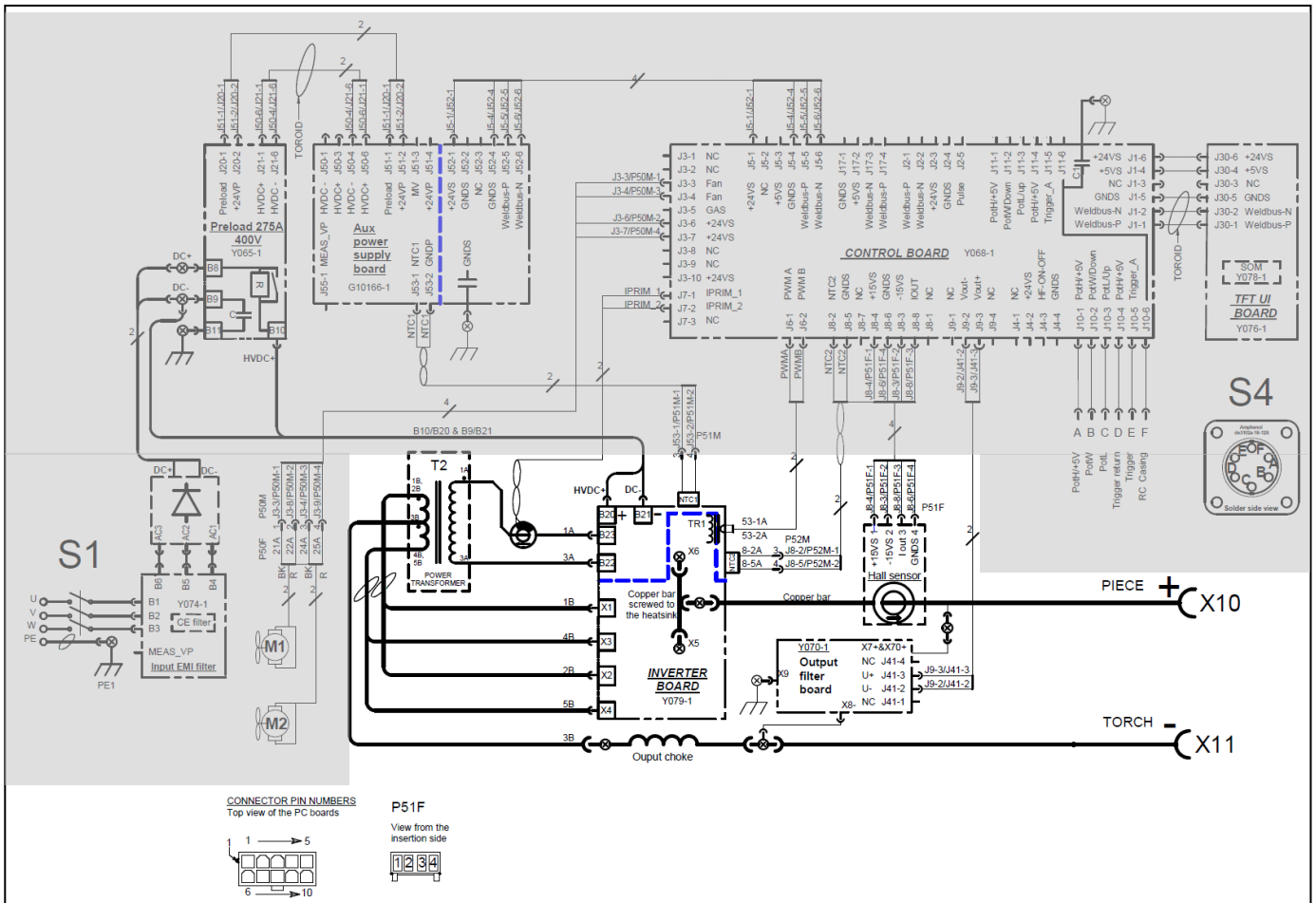

INVERTER AND OUTPUT CIRCUITS, MAIN TRANSFORMER AND OUTPUT SECTIONS

The inverter board receives the rectified primary power from the Preload Board (565Vdc) and it converts this power from DC to AC high frequency that is applied to the primary windings of the main welding transformer (T2).

The primary winding of the main welding transformer receives the Pulse Width Modulated power from the switch board. The AC output that is created on the secondary windings is applied to the output rectifier circuit (located on the same board of the Inverter circuits).

The resultant rectified DC- power is applied, through an output choke, to the negative output terminal. The DC+ pass through the current transducer and it is connected to the positive stud.

The output choke provides filtering to enhance the arc performance and accurate waveform response.

The current transducer provides an accurate feedback of output current to the control circuits section of the control board to obtain the correct output characteristic.

CONTROL BOARD – TFT UI BOARD

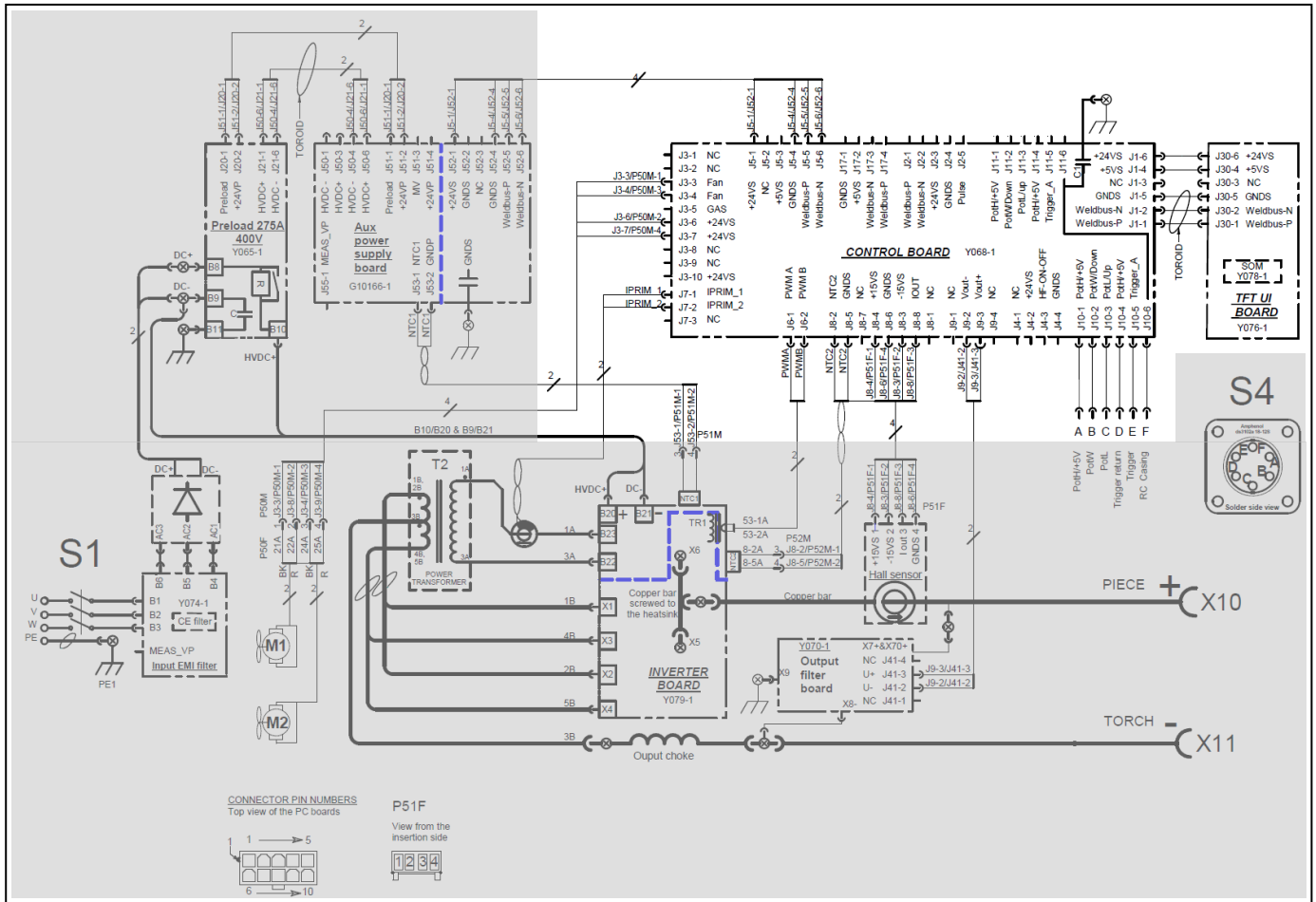

CONTROL BOARD AND TFT UI BOARD

The Control Board managing all the functions of the machine, a microprocessor is present on it to make the correct operations. The Control Board receives signals from different area of the machine, power supply from Aux. Power Supply board and selecting parameters from the User Interface to create the reference signal for the inverter.

Control Board and User interface communicate via serial bus.

The Control Board supplies power for the User Interface Board and supplies signals to the User Interface to show set and actual current values, error codes and pre-set values. The remote control signals (Pins A, B & C) are also fed into the Control Board from the 6 pins connector located on the front of the machine.

OVERLOAD PROTECTION

CITOARC® 275 is electrically protected from producing higher output currents. An electronic protection circuit limits the current to within the capabilities of the machine.

THERMAL PROTECTION

Thermal Protection Devices protect the machine from excessive operating temperatures. Excessive temperature may be caused by a lack of cooling air or by operating the machine beyond the

duty cycle and output rating. If excessive operating temperature should occur, the Thermal LED indicator on the front panel, will turn ON and the thermostat will prevent output current.

The thermal protections are self-resetting once the machine cools sufficiently. If the shut down was caused by excessive output or duty cycle and the fan is operating normally, the power switch may be left on and the reset should occur within about 15 minute period. If the fan is not turning or the air intake louvers are obstructed, the input power must be removed and the fan problem or air obstruction must be corrected.

INSULATED GATE BIPOLAR TRANSISTOR (IGBT) OPERATION

An IGBT is a type of transistor. IGBTs are semiconductors well suited for high frequency switching and high current applications. Drawing A shows an IGBT in a passive mode. There is no gate signal, zero volts relative to the source, and therefore, no current flow. The drain terminal of the IGBT may be connected to a voltage supply; but since there is no conduction the circuit will not supply current to components connected to the source. The circuit is turned off like a light switch in the OFF position.

Drawing B shows the IGBT in an active mode. When the gate signal, a positive DC voltage relative to the source, is applied to the gate terminal of the IGBT, it is capable of conducting current. A voltage supply connected to the drain terminal will allow the IGBT to conduct and supply current to circuit components coupled to the source. Current will flow through the conducting IGBT to downstream components as long as the positive gate signal is present. This is similar to turning ON a light switch

IGBT

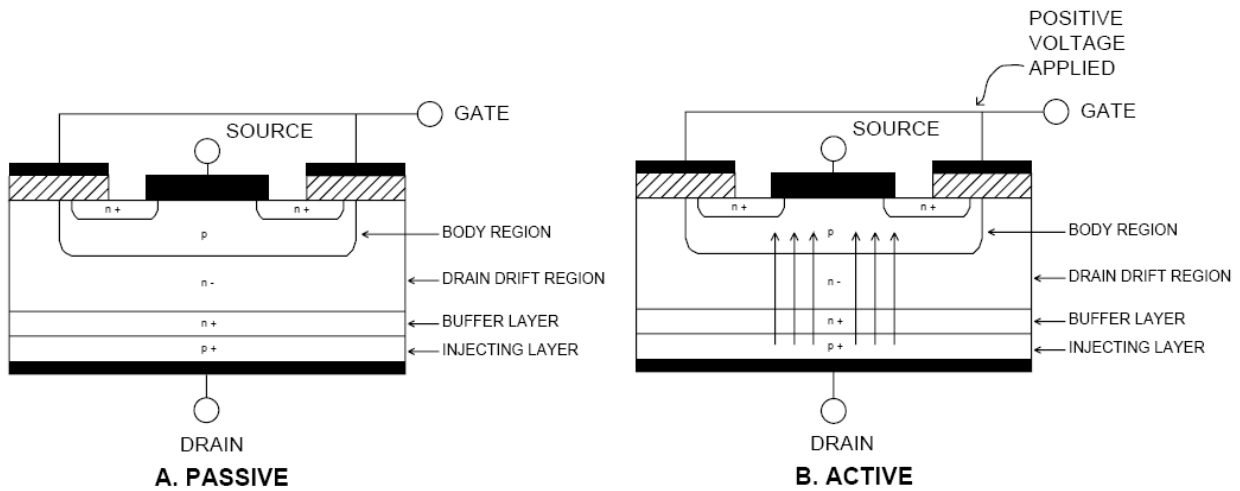

TROUBLESHOOTING AND REPAIR SECTION

- How to use troubleshooting Guide
- Troubleshooting Guide
- Case cover removal and capacitor discharge procedure
- EMI filter board resistance test
- Input rectifier resistance test
- Inverter board and output diodes resistance test
- Thermal protection resistance test
- Output studs resistance test
- EMI filter board voltage test
- Input rectifier voltage test
- Preload board voltage test
- Aux. power supply board voltage test
- Inverter and output board voltage test
- Control board voltage test

HOW TO USE TROUBLESHOOTING GUIDE

Service and repair should be performed by only Lincoln Electric Factory Trained Personnel. Unauthorized repairs performed on this equipment may result in danger to the technician and machine operator and will invalidate your factory warranty. For your safety and to avoid Electrical Shock, please observe all safety notes and precautions detailed throughout this manual.

.....

This Troubleshooting Guide is provided to help you locate and repair possible machine malfunctions. Simply follow the three-step procedure listed below.

Step 1. LOCATE PROBLEM (SYMPTOM). Look under the column labeled "PROBLEMS". This column describes possible symptoms that the machine may exhibit. Find the listing that best describes the symptom that the machine is exhibiting. Symptoms are grouped into three main categories: Output Problems, Function Problems, and LED Function Problems.

Step 2. PERFORM EXTERNAL TESTS. The second column, labeled "CHECKS", lists the obvious external possibilities that may contribute to the machine symptom. Perform these tests/checks in the order listed. In general, these tests can be conducted without removing the case wrap-around cover.

Step 3. PERFORM COMPONENT TESTS. The last column, labeled "RECOMMENDED COURSE OF ACTION" lists the most likely components that may have failed in your machine. It also specifies the appropriate test procedure to verify that the subject component is either good or bad. If there are a number of possible components, check the components in the order listed to eliminate one possibility at a time until you locate the cause of your problem.

All of the referenced test procedures referred to in the Troubleshooting Guide are described in detail at the end of this chapter. Refer to the Troubleshooting and Repair Table of Contents to locate each specific Test Procedure. All of the referred to test points, components, terminal strips, etc., can be found on the referenced electrical wiring diagrams and schematics. Refer to the Wiring Diagrams Section Table of Contents to locate the appropriate diagram.

WARNING



ELECTRIC SHOCK can kill

- Have an electrician install and service this equipment
- Turn the input power off at the fuse box before working on equipment
- Do not touch electrically hot parts
- Prior to performing preventive maintenance, perform the following capacitor discharge procedure to avoid electric shock

Sometimes machine failures appear to be due to PC board failures. These problems can sometimes be traced to poor electrical connections. To avoid problems when troubleshooting and replacing PC boards, please use the following procedure:

1. Determine to the best of your technical ability that the PC board is the most likely component causing the failure symptom.
2. Check for loose connections at the PC board to assure that the PC board is properly connected.
3. If the problem persists, replace the suspect PC board using standard practices to avoid static electrical damage and electrical shock.
4. Test the machine to determine if the failure symptom has been corrected by the replacement PC board.

NOTE: Allow the machine to heat up so that all electrical components can reach their operating temperature.

5. Remove the replacement PC board and substitute it with the original PC board to recreate the original problem.
 - If the original problem does not reappear by substituting the original board, then the PC board was not the problem. Continue to look for bad connections in the control wiring harness, junction blocks, and terminal strips.
 - If the original problem is recreated by the substitution of the original board, then the PC board was the problem. Reinstall the replacement PC board and test the machine.
6. Always indicate that this procedure was followed when warranty reports are to be submitted.

NOTE: Following this procedure and writing on the warranty report, "INSTALLED AND SWITCHED PC BOARDS TO VERIFY PROBLEM," will help avoid denial of legitimate PC board warranty claims.

TROUBLESHOOTING

!! WARNING !! BEFORE CONNECT POWER SUPPLY, MAKE A CAREFUL VISUAL INSPECTION INSIDE THE MACHINE, CHECK ALL THE BOARDS AND HARNESS.

PROBLEMS / SYMPTOMS	CHECKS / ERROR DESCRIPTION	RECOMMENDED COURSE OF ACTION
A VISUAL DAMAGE IS EVIDENT WHEN YOU OPEN THE COVER	-----	<ul style="list-style-type: none"> REPLACE THE BROKEN PART AND PERFORM THE TESTS FOR THE OTHER MACHINE COMPONENTS
MACHINE IS DEAD, NO STATUS LED	<ul style="list-style-type: none"> MAKE SURE THAT THE INPUT LINE IS PRESENT CHECK THE MACHINE ON/OFF SWITCH CHECK THE PRESENCE OF THE 565 Vdc AT THE INPUT RECTIFIER DC+ AND DC- 	<ul style="list-style-type: none"> CONNECT THE INPUT LINE REPLACE THE MACHINE ON/OFF SWITCH IF NECESSARY PERFORM THE INPUT RECTIFIER VOLTAGE TEST AND THE PRELOAD BOARD TEST AVAILABLE ON THIS MANUAL
THE MAIN INPUT FUSES REPEATEDLY FAIL OR THE INPUT LINE CIRCUIT BREAKER TRIPPING	<ul style="list-style-type: none"> MAKE CERTAIN THE FUSES OR BREAKERS ARE PROPERLY SIZED FOR THE INPUT DRAW OF THE MACHINE. SEE MACHINE RATING PLATE OR TECHNICAL SPECIFICATION AVAILABLE IN THIS SERVICE MANUAL A SHORT CIRCUIT MAY BE PRESENT INSIDE THE MACHINE 	<ul style="list-style-type: none"> PERFORM THE 3PH INPUT RECTIFIER BRIDGE PERFORM THE INVERTER BOARD TEST
THERE IS NO WELDING OUTPUT	<ul style="list-style-type: none"> MAKE SURE THAT THE RECTIFIED VOLTAGE IS APPLIED TO THE INVERTER BOARD. ONE OF THE MACHINE THERMAL SENSOR MAY HAS TRIPPED, CHECK THERMAL STATUS LED. MAY BE ONE OF THE OUTPUT RECTIFIER DIODE IS IN SHORT CIRCUIT 	<ul style="list-style-type: none"> CHECK THE PRESENCE OF THE INPUT 3 PHASES AT INPUT SWITCH , EMI FILTER; PERFORM THE EMC FILTER BOARD AND INPUT RECTIFIER BRIDGE TESTS DO NOT TURN THE UNIT OFF, ALLOW THE MACHINE TO COOL DOWN, THE THERMAL PROTECTION CIRCUITS WILL RESET THEMSELVES, IF NOT CHECK THE THERMAL SENSORS AND THERMAL SENSORS CIRCUIT PERFORM THE OUTPUT RECTIFIER MODULES TESTS
THE THERMAL LAMP IS ON, THE MACHINE OVERHEAT VERY FREQUENTLY	<ul style="list-style-type: none"> THE WELDING CURRENT USED MAY EXCEED THE MACHINE DUTY CYCLE DUST MAY HAVE CLOGGED THE COOLING HEAT-SINK LOUVERS MAY BE BLOCKED BY INADEQUATE CLEARANCE AROUND THE MACHINE MAY BE THE FAN IS NOT WORKING 	<ul style="list-style-type: none"> CHECK AND FOLLOW THE MACHINE DUTY CYCLE CLEAN THE MACHINE USING DRY COMPRESSED AIR REMOVE ANY PARTS AROUND THE MACHINE THAT MAY BLOCK THE AIR FLOW AND THE LOUVERS PERFORM THE FANS TEST

These tests and repair should only be performed by Lincoln Electric Factory Trained Personnel. Unauthorized repairs performed on this equipment may result in danger to the technician and machine operator and will invalidate your factory warranty. For your safety and to avoid Electrical Shock, please observe all safety notes and precautions detailed throughout this manual.

CASE COVER REMOVAL AND DC BUS CAPACITOR DISCHARGE PROCEDURE

WARNING

Service and repair should be performed only by Lincoln Electric factory trained personnel. Unauthorized repairs performed on this equipment may result in danger to the technician or machine operator and will invalidate your factory warranty. For your safety and to avoid electrical shock, please observe all safety notes and precautions detailed throughout this manual.

If for any reason you do not understand the test procedures or are unable to perform the test/repairs safely, contact your Local Lincoln Electric Service Department for electrical troubleshooting assistance before you proceed.

.....

DESCRIPTION

This procedure will aid the technician in the removal and replacement of the case sheet metal cover and discharging the DC link capacitor making it safe for the technician to work on the machine.

MATERIALS NEEDED

TORX wrench TX-25

CITOARC® 275 - SIDE PANELS REMOVAL

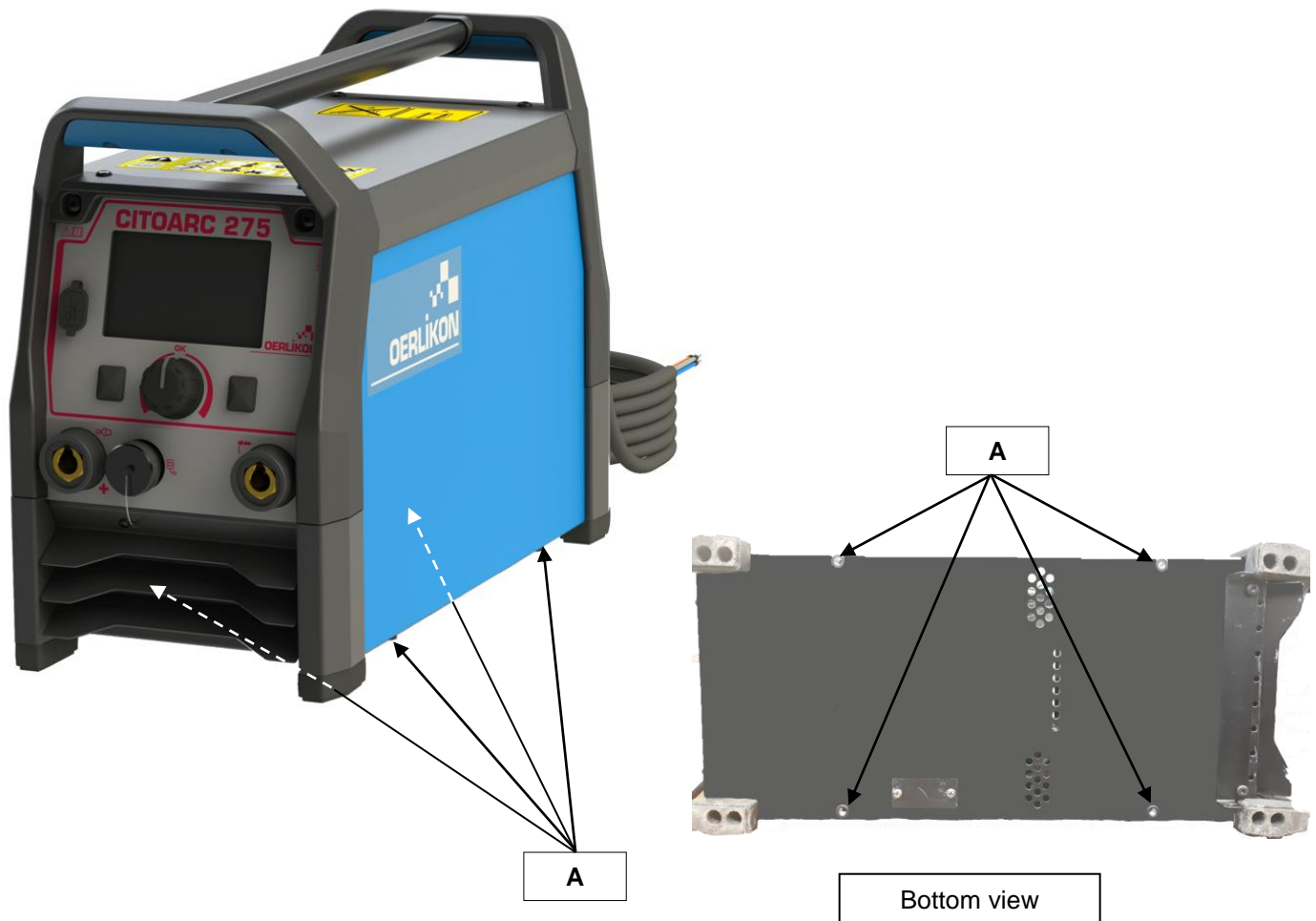

Procedure:

1. Turn ON/OFF switch to OFF position.
2. **Disconnect Input Power from the machine !**
3. Using the TORX wrench TX-25 driver, remove the 4 screws (**A**) on the bottom of machine
4. Remove the two side panels sliding them downward, taking care to disconnect the two ground wires connected to each panel.
5. Follow the next page for **DC BUS capacitors discharge procedure!**

DC BUS CAPACITORS DISCHARGE PROCEDURE

WARNING



ELECTRIC SHOCK can kill

Have an electrician install and service this equipment
Turn the input power off at the fuse box before working on equipment

Do not touch electrically hot parts

Prior to performing preventive maintenance, perform the following capacitor discharge procedure to avoid electric shock.

DC BUS CAPACITORS DISCHARGE PROCEDURE

1. Remove input power to the CITOARC® 275
2. Remove the side panels following the instruction available in this Service manual.
3. Obtain a high resistance and high wattage resistor (25-1000 ohms and 25 watts minimum). This resistor is NOT supplied with the machine. NEVER USE A SHORTING STRAP FOR THIS PROCEDURE.
4. Locate the two terminals **DC+** and **DC -** on the Switch Board on the right side of the machine (**See Figure 1**).
5. Use electrically insulate gloves and insulated pliers. Hold the body of the resistor and connect the resistor leads across the two terminals. Hold the resistor in place for 10 seconds. DO NOT TOUCH CAPACITOR TERMINALS WITH YOUR BARE HANDS.
6. Check the voltage across the two terminals. Voltage should be zero. If any voltage remains, repeat this procedure.

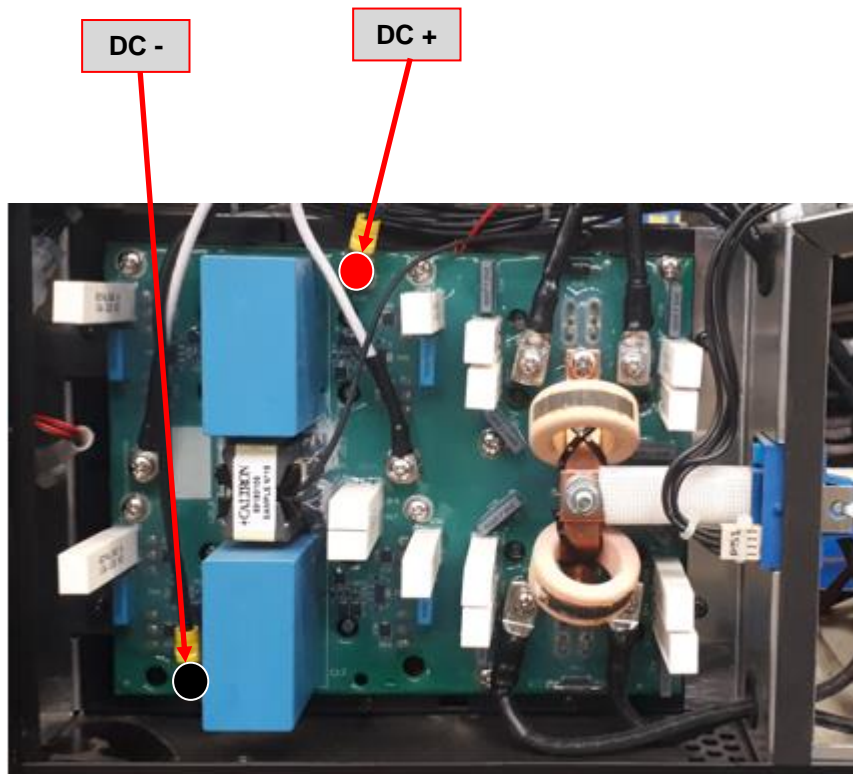

Figure 1
Showing machine left side

EMI FILTER BOARD RESISTANCE TEST

WARNING

Service and repair should be performed by only Lincoln Electric factory trained personnel. Unauthorized repairs performed on this equipment may result in danger to the technician or machine operator and will invalidate your factory warranty. For your safety and to avoid electrical shock, please observe all safety notes and precautions detailed throughout this manual. If for any reason you do not understand the test procedures or are unable to perform the test/repairs safely, contact your Local Lincoln Electric Service Department for electrical troubleshooting assistance before you proceed.

.....

TEST DESCRIPTION

This test will determine if the EMI Filter board has failed.

MATERIALS NEEDED

Multimeter
Machine wiring diagram

EMI FILTER BOARD RESISTANCE TEST (continued)

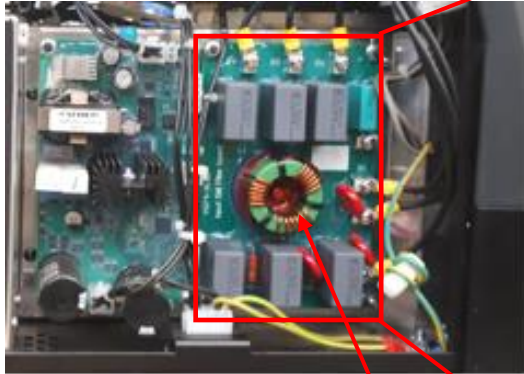

Figure 2

EMI FILTER BOARD

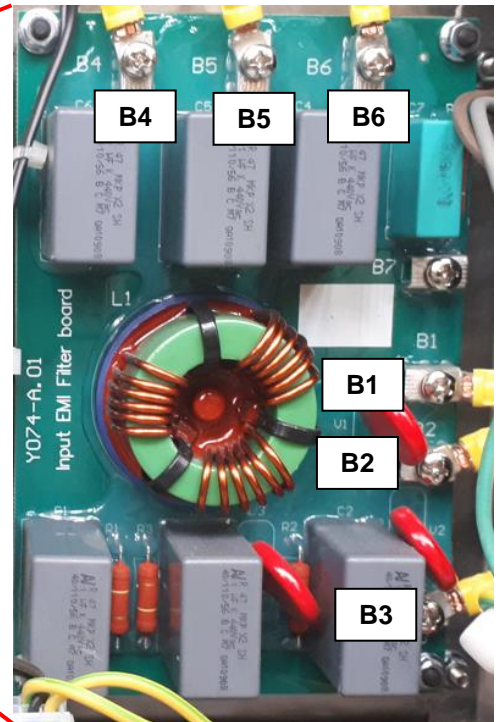

Figure 2a

TEST PROCEDURE

⚠ Use always electrically insulate gloves during this test procedure

1. Remove main input power to the CITOARC® 275
2. Perform the **Side Panels removal** and **Discharge procedure**
3. Locate the EMI filter board on the right side of the machine. **See Figure 2**
4. Visually check for burned or damaged components. If any components are physically damaged they have to be replaced
5. Using the multimeter (ohm mode) perform the tests as indicated in **Test Table 1**. See **Figure 2a** for correct test points location.

Test table 1 – EMI FILTER BOARD test

<i>Machine condition</i>	<i>Probe</i>	<i>Probe</i>	<i>Value</i>
Machine disconnected from input voltage and capacitors discharged.	B1	B4	Less than 10 ohms
	B2	B5	Less than 10 ohms
	B3	B6	Less than 10 ohms

INPUT RECTIFIER RESISTANCE TEST

WARNING

Service and repair should be performed by only Lincoln Electric factory trained personnel. Unauthorized repairs performed on this equipment may result in danger to the technician or machine operator and will invalidate your factory warranty. For your safety and to avoid electrical shock, please observe all safety notes and precautions detailed throughout this manual. If for any reason you do not understand the test procedures or are unable to perform the test/repairs safely, contact your Local Lincoln Electric Service Department for electrical troubleshooting assistance before you proceed.

.....

TEST DESCRIPTION

This test will determine if the Input Rectifier Bridge has failed.

MATERIALS NEEDED

Multimeter
8mm nut driver
Machine Wiring Diagram

INPUT RECTIFIER RESISTANCE TEST (continued)

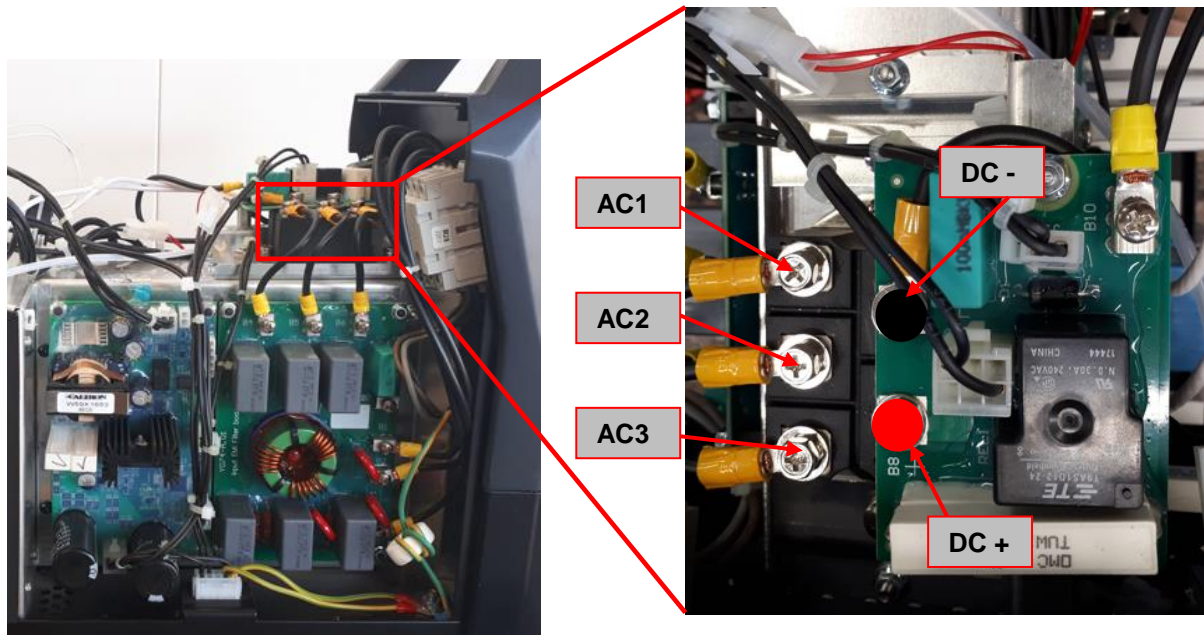

Figure 3 – Input Rectifier Bridge location and Test Points

TEST PROCEDURE

⚠ Use always electrically insulate gloves during this test procedure

1. Remove main input power to the CITOARC® 275.
2. Perform the **Side Panels removal** and **Discharge procedure**
3. Locate the Input Rectifier Bridge. See **Figure 3**.
4. Using the multimeter (diode test mode) perform the tests as detailed in **Test table 2**. See also **Figure 3** for terminals locations.
5. If the tests results are questionable, label and remove all of the leads from the Input Rectifier Bridge and re-test.
6. If any portion of the test fails, the input rectifier may be faulty and it must be replaced.

Test table 2 – Input Rectifier Bridge Test

Positive Probe (RED)	Negative Probe (BLACK)	Value
Terminal AC1	Terminal AC2 – AC3	Open
Terminal AC2	Terminal AC1 – AC3	Open
Terminal AC3	Terminal AC1 – AC2	Open
Terminal AC1 – AC2 – AC3	DC+	Open
Terminal AC1 – AC2 – AC3	DC-	0,3-0,4

INVERTER BOARD AND OUTPUT DIODES RESISTANCE TEST

WARNING

Service and repair should be performed by only Lincoln Electric factory trained personnel. Unauthorized repairs performed on this equipment may result in danger to the technician or machine operator and will invalidate your factory warranty. For your safety and to avoid electrical shock, please observe all safety notes and precautions detailed throughout this manual. If for any reason you do not understand the test procedures or are unable to perform the test/repairs safely, contact your Local Lincoln Electric Service Department for electrical troubleshooting assistance before you proceed.

.....

TEST DESCRIPTION

This test will help to determine if the power section of the inverter board is working correctly. This test will not indicate if the entire board is functional.

MATERIALS NEEDED

Multimeter
Machine schematic
PH02 screw driver

INVERTER BOARD AND OUTPUT DIODES RESISTANCE TEST (continued)

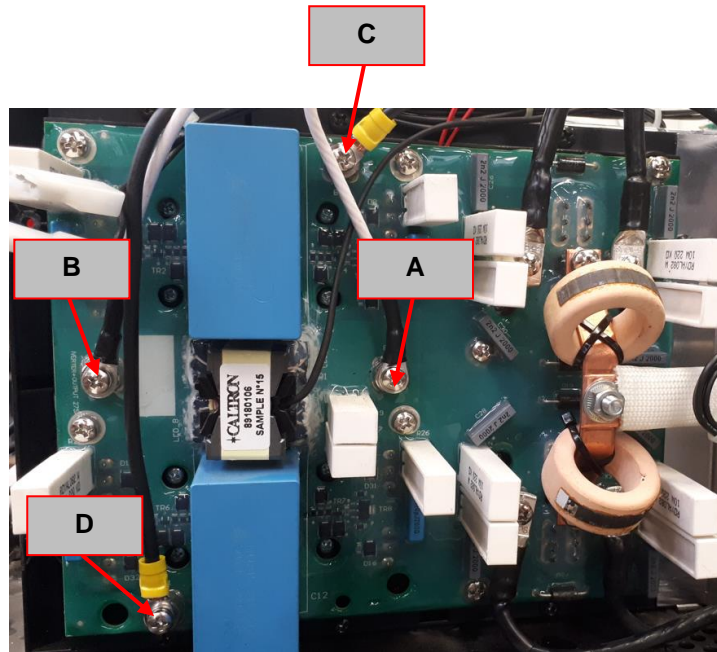

Figure 4 – Inverter Board location and Test Points

TEST PROCEDURE

⚠ Use always electrically insulate gloves during this test procedure

1. Remove main input power to the CITOARC® 275.
2. Perform the **Side Panels removal** and **Discharge procedure**
3. Locate the Inverter board. See **Figure 4**.
4. Visually check for burned or damaged components. If any components are physically damaged Inverter board should be replaced
5. Using the PH02 screwdriver disconnect the cables (A), (B), (C) and (D) and mark them
6. Using the multimeter in diode test mode perform the tests detailed in **Test Table 3**. See **Figure 4** for Test Point locations.

Test table 3 – Inverter board resistance test

Positive Probe (RED)	Negative Probe (BLACK)	Value
D	C	0.4 – 0.7V Forward Voltage Drop
C	D	Open
C	B	Open
B	D	Open
B	C	0.4 – 0.6V Forward Voltage Drop
D	B	0.4 – 0.6V Forward Voltage Drop
A	C	0.4 – 0.6V Forward Voltage Drop
D	A	0.4 – 0.6V Forward Voltage Drop
C	A	Open
A	D	Open

7. Reconnect all cables previously disconnected

Note: If any of the above test fails the Inverter board may be faulty and must be replaced

INVERTER BOARD AND OUTPUT DIODES RESISTANCE TEST (continued)

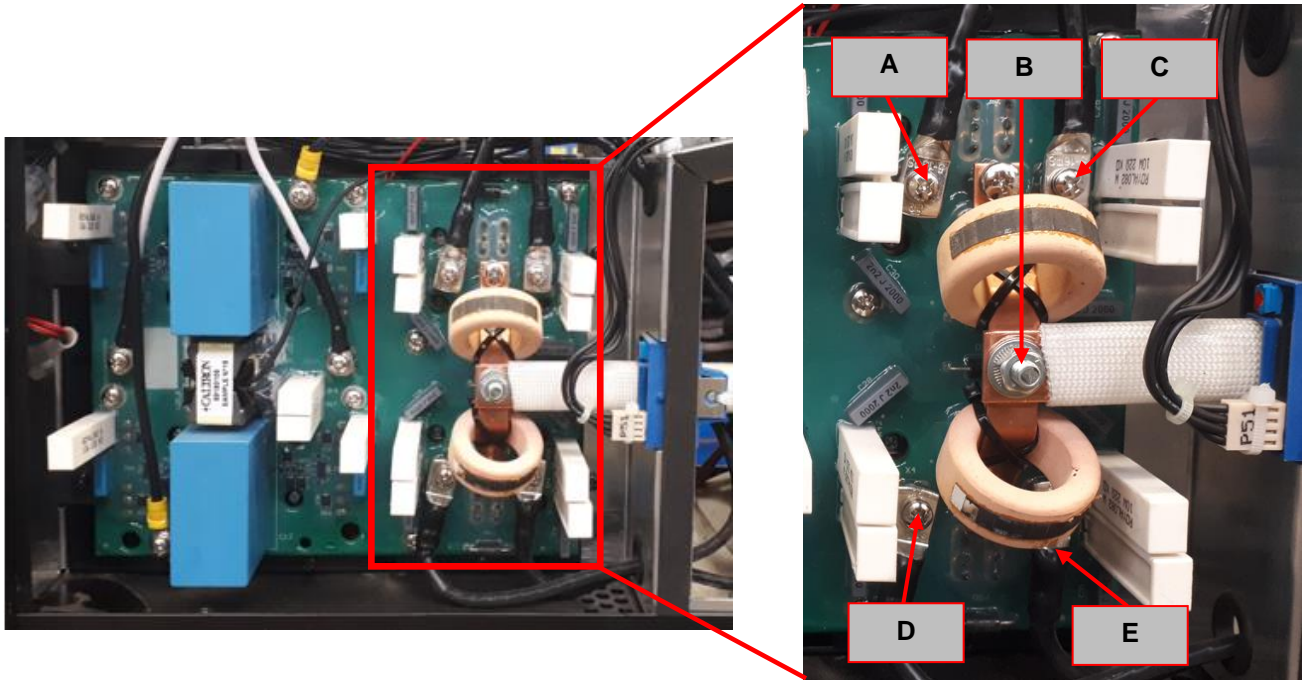

Figure 5 – Output Diodes location and Test Points

TEST PROCEDURE

⚠ Use always electrically insulate gloves during this test procedure

1. Remove main input power to the CITOARC® 275.
2. Perform the **Side Panels removal** and **Discharge procedure**
3. Locate the Output Diodes location. See **Figure 5**. The Output Diodes are part of the Inverter board.
4. No cables have to be disconnected
5. Using the multimeter in diode test mode perform the tests detailed in **Test Table 4**. See **Figure 5** for Test Point locations.

Test table 4 – Output Diodes Test

<i>Positive Probe (RED)</i>	<i>Negative Probe (BLACK)</i>	<i>Value</i>
B	A	0,99
B	C	0,99
A	B	0,3
C	B	0,3
D	E	0,3
F	E	0,3
E	D	0,99
E	F	0,99

THERMAL PROTECTION RESISTANCE TEST

WARNING

Service and repair should be performed by only Lincoln Electric factory trained personnel. Unauthorized repairs performed on this equipment may result in danger to the technician or machine operator and will invalidate your factory warranty. For your safety and to avoid electrical shock, please observe all safety notes and precautions detailed throughout this manual. If for any reason you do not understand the test procedures or are unable to perform the test/repairs safely, contact your Local Lincoln Electric Service Department for electrical troubleshooting assistance before you proceed.

.....

TEST DESCRIPTION

This test will help determine if the NTC Thermal Protection are Ok.

MATERIALS NEEDED

Multimeter
Machine schematic

THERMAL PROTECTION RESISTANCE TEST (continued)

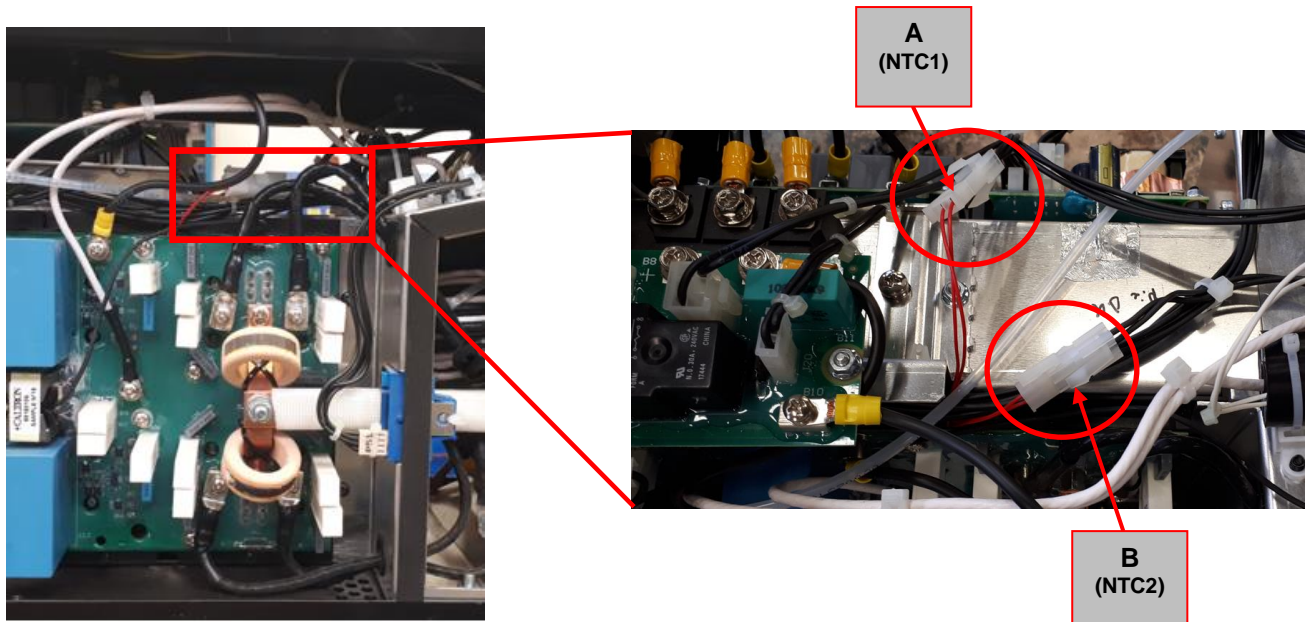

Figure 7 – NTC Thermal sensors connectors location

TEST PROCEDURE

⚠ Use always electrically insulate gloves during this test procedure

1. Remove main input power to the CITOARC® 275.
2. Perform the **Side Panels removal** and **Discharge procedure**
3. Locate the male and female connector of the two NTC (NTC1 protects the Inverter Power components and NTC2 the output diodes). See **Figure 7**.
4. Disconnect the male connector from the female of NTC1 and chek the resistance value between the two red wires. Correct Value should be about **10 Kohms @25°C**.
5. Repeat the same measure with NTC2.
6. Reconnect the male and female connectors.

OUTPUT STUDS RESISTANCE TEST

WARNING

Service and repair should be performed by only Lincoln Electric factory trained personnel. Unauthorized repairs performed on this equipment may result in danger to the technician or machine operator and will invalidate your factory warranty. For your safety and to avoid electrical shock, please observe all safety notes and precautions detailed throughout this manual. If for any reason you do not understand the test procedures or are unable to perform the test/repairs safely, contact your Local Lincoln Electric Service Department for electrical troubleshooting assistance before you proceed.

.....

TEST DESCRIPTION

This test will help determine if the output of the machine has the correct resistance value.

MATERIALS NEEDED

Multimeter
Machine schematic

OUTPUT STUDS RESISTANCE TEST (continued)



Figure 8 – Output studs location

TEST PROCEDURE

⚠ Use always electrically insulate gloves during this test procedure

1. Remove main input power to the CITOARC® 275.
2. Perform the **Side Panels removal** and **Discharge procedure**
3. Locate the Output Studs. See **Figure 8**.
4. Using the ohmmeter check the resistance value between the Positive and Negative Studs, correct value should be between 4-5 Kohms.
5. If different value is measured, perform the output diode test.

EMI FILTER BOARD VOLTAGE TEST

WARNING

Service and repair should be performed by only Lincoln Electric factory trained personnel. Unauthorized repairs performed on this equipment may result in danger to the technician or machine operator and will invalidate your factory warranty. For your safety and to avoid electrical shock, please observe all safety notes and precautions detailed throughout this manual. If for any reason you do not understand the test procedures or are unable to perform the test/repairs safely, contact your Local Lincoln Electric Service Department for electrical troubleshooting assistance before you proceed.

.....

TEST DESCRIPTION

This test will help to determine if the input voltage applied to the EMI filter is passing through it and arrive correctly to the Preload board.

MATERIALS NEEDED

Volt/Ohmmeter
Machine Wiring Diagrams

EMI FILTER BOARD VOLTAGE TEST (continued)

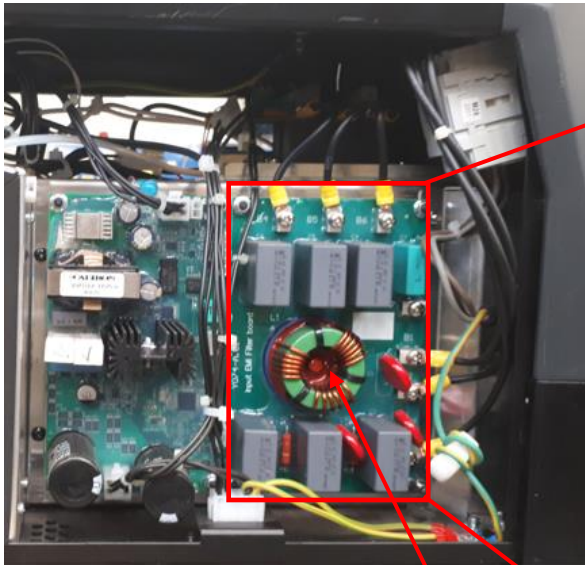

Figure 9

EMI FILTER BOARD

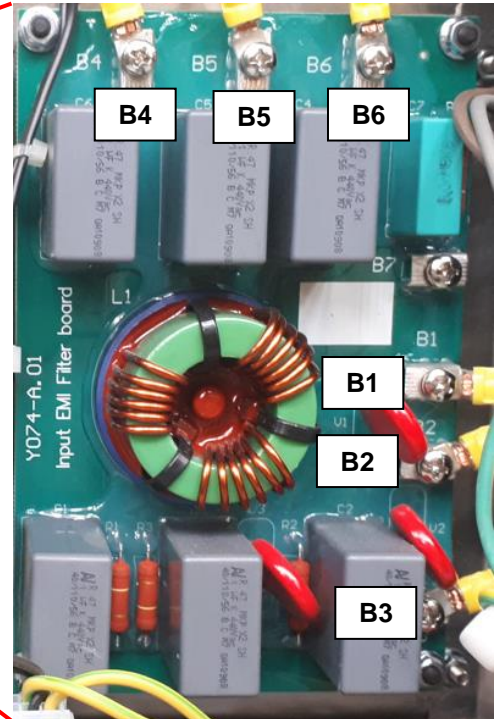

Figure 9a

TEST PROCEDURE

⚠ Use always electrically insulate gloves during this test procedure

1. Remove main input power to the CITOARC® 275.
2. Perform the **Side Panels removal** and **Discharge procedure** available in this Service Manual
3. Apply 400 Vac +/- 10% to the CITOARC® 275.
4. Switch ON the machine.
5. Check between EMI filter input voltage points **B1**, **B2** and **B3** for 400Vac +/- 10% and between EMI output points **B4**, **B5** and **B6** also for 400Vac +/- 10%

INPUT RECTIFIER VOLTAGE TEST

WARNING

Service and repair should be performed by only Lincoln Electric factory trained personnel. Unauthorized repairs performed on this equipment may result in danger to the technician or machine operator and will invalidate your factory warranty. For your safety and to avoid electrical shock, please observe all safety notes and precautions detailed throughout this manual. If for any reason you do not understand the test procedures or are unable to perform the test/repairs safely, contact your Local Lincoln Electric Service Department for electrical troubleshooting assistance before you proceed.

.....

TEST DESCRIPTION

This test will determine if the Input Rectifier Bridge is working.

MATERIALS NEEDED

Multimeter
Machine Wiring Diagram

INPUT RECTIFIER VOLTAGE TEST (continue)

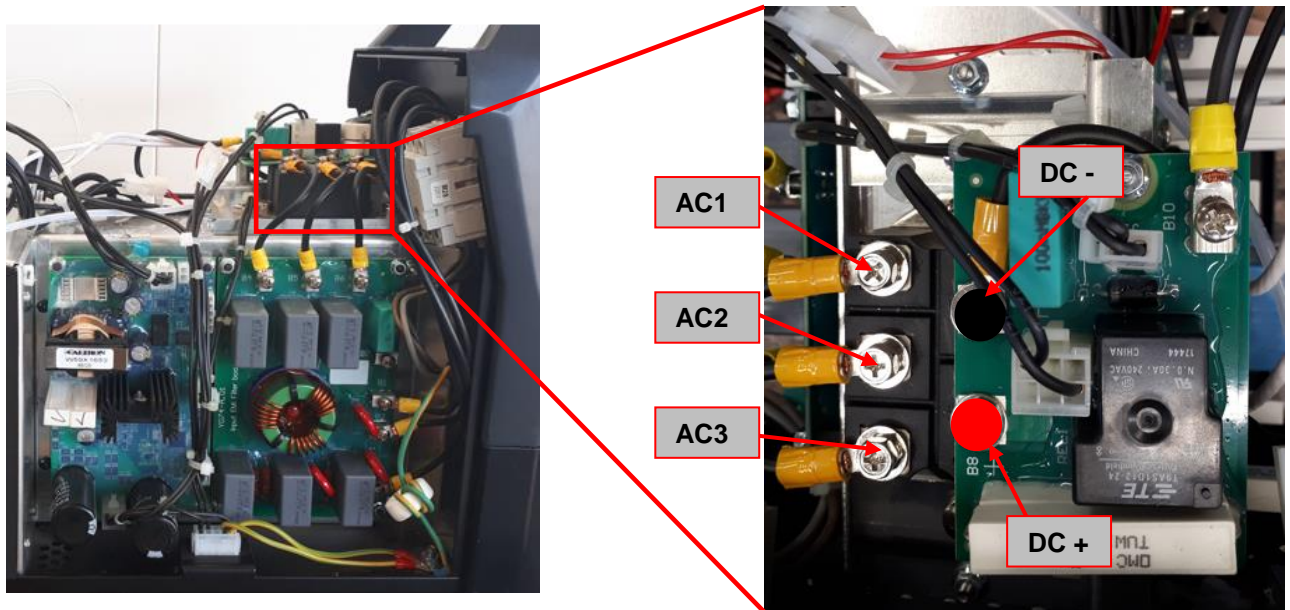

Figure 10 – Input Rectifier Bridge location and Test Points

TEST PROCEDURE

⚠ Use always electrically insulate gloves during this test procedure

1. Remove main input power to the CITOARC® 275.
2. Perform the **Side Panels removal** and **Discharge procedure** available in this Service Manual
3. Apply 400 Vac +/- 10% to the CITOARC® 275.
7. Switch ON the machine
8. Using the multimeter in VAC and VDC mode perform the tests as indicated in **Test Table 5**. See **Figure 10** for correct test points location.

Test table 5 – Input Rectifier Bridge Voltage Test

Positive Probe (RED)	Negative Probe (BLACK)	Value
Terminal AC1	Terminal AC2	400Vac +/-15%
Terminal AC2	Terminal AC3	400Vac +/-15%
Terminal AC1	Terminal AC3	400Vac +/-15%
Terminal DC+	Terminal DC-	565 Vdc +/-15%

PRELOAD BOARD VOLTAGE TEST

WARNING

Service and repair should be performed by only Lincoln Electric factory trained personnel. Unauthorized repairs performed on this equipment may result in danger to the technician or machine operator and will invalidate your factory warranty. For your safety and to avoid electrical shock, please observe all safety notes and precautions detailed throughout this manual. If for any reason you do not understand the test procedures or are unable to perform the test/repairs safely, contact your Local Lincoln Electric Service Department for electrical troubleshooting assistance before you proceed.

.....

TEST DESCRIPTION

This test will determine if the Preload Board is working properly.

MATERIALS NEEDED

Multimeter
Machine Wiring Diagram

PRELOAD BOARD VOLTAGE TEST (continued)

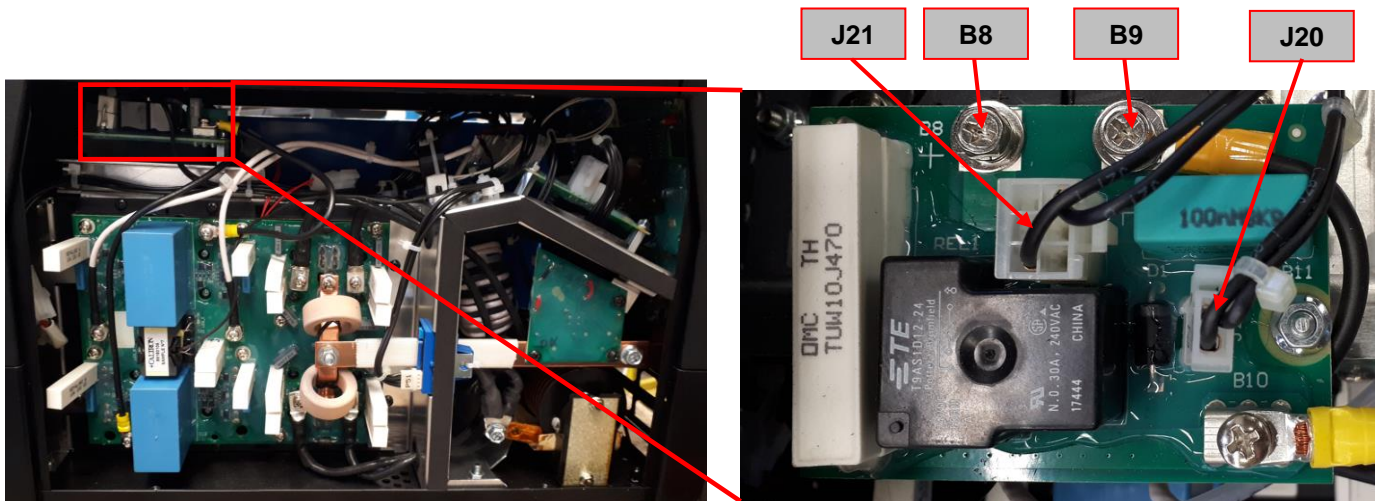

Figure 11 – Preload Board location and Test Points

TEST PROCEDURE

⚠ Use always electrically insulate gloves during this test procedure

1. Remove main input power to the CITOARC® 275.
2. Perform the **Side Panels removal** and **Discharge procedure** available in this Service Manual
3. Apply 400 Vac +/- 10% to the CITOARC® 275.
4. Switch ON the machine
5. Using the multimeter in VDC mode perform the tests as indicated in **Test Table 6**. See **Figure 11** for correct test points location.

Test table 6 – Preload Board Voltage Test

<i>Positive Probe (RED)</i>	<i>Negative Probe (BLACK)</i>	<i>Value</i>
B8	B9	565 Vdc +/-15%
J20 / pin 2	J20 / pin 1	24 Vdc
J21 / pin 1	J21 / pin 6	565 Vdc +/-15%

AUX. POWER SUPPLY BOARD VOLTAGE TEST

WARNING

Service and repair should be performed by only Lincoln Electric factory trained personnel. Unauthorized repairs performed on this equipment may result in danger to the technician or machine operator and will invalidate your factory warranty. For your safety and to avoid electrical shock, please observe all safety notes and precautions detailed throughout this manual. If for any reason you do not understand the test procedures or are unable to perform the test/repairs safely, contact your Local Lincoln Electric Service Department for electrical troubleshooting assistance before you proceed.

.....

TEST DESCRIPTION

This test will determine if the Aux. Power Supply Board is providing proper auxiliary voltages.

MATERIALS NEEDED

Multimeter
Machine Wiring Diagram

AUX. POWER SUPPLY BOARD VOLTAGE TEST (continue)

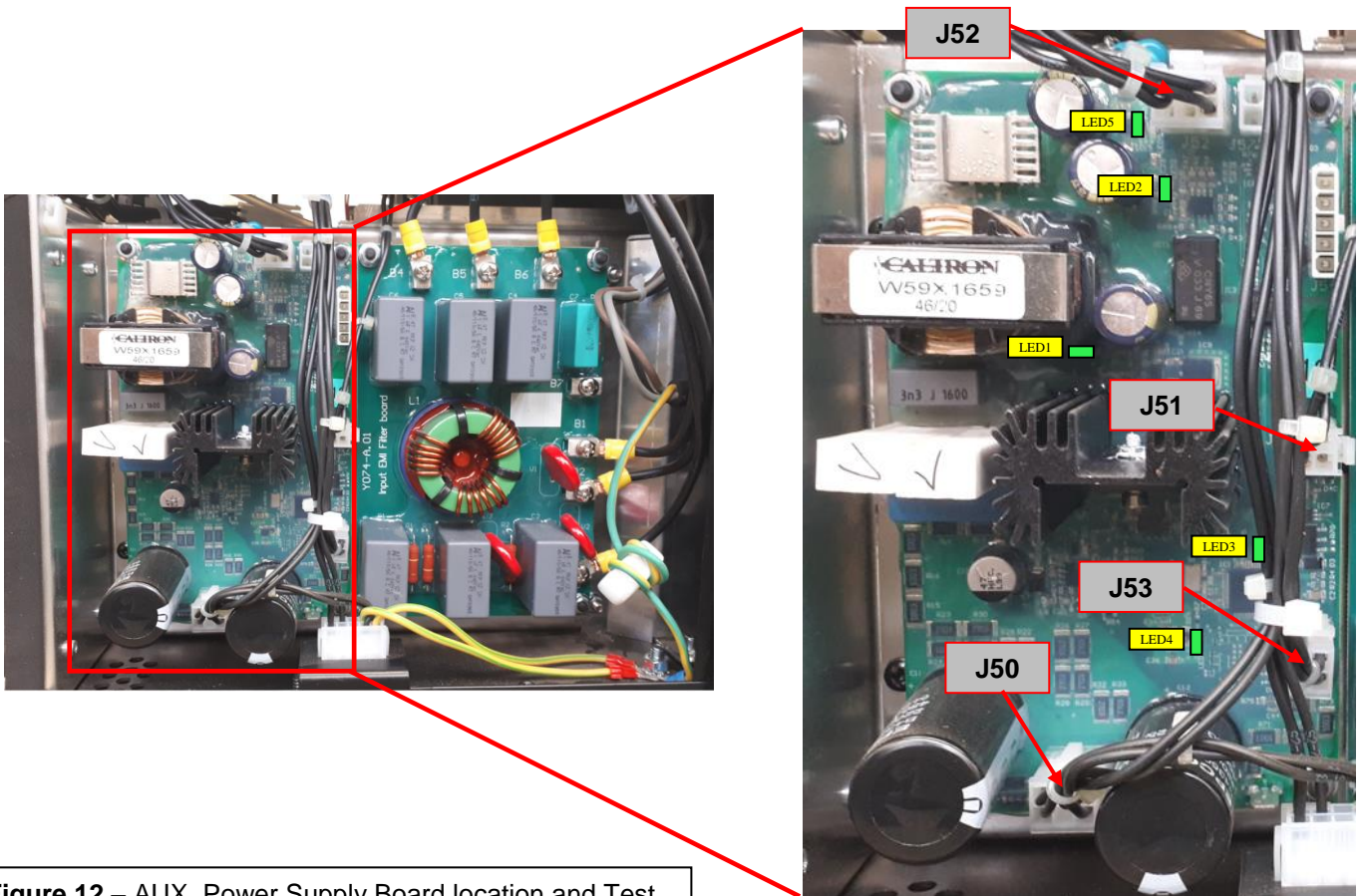

Figure 12 – AUX. Power Supply Board location and Test

TEST PROCEDURE

WARNING: Black heatsink on primary side: Do not touch it.

⚠ Use always electrically insulate gloves during this test procedure

1. Remove main input power to the CITOARC® 275.
2. Perform the **Side Panels removal** and **Discharge procedure** available in this Service Manual
3. Apply 400 Vac +/- 10% to the CITOARC® 275.
4. Switch ON the machine
5. Check LEDs following the table here below.

LEDs Table

LED #	Description	Status	Notes
LED1	+15 Vdc primary side	Always ON - GREEN	It indicates that the 15Vdc is present
LED2	+ 24Vdc secondary side	Always ON - GREEN	It indicates that the 24Vdc is present
LED3	Microprocessor Heartbeat	Always flashing (GREEN)	It indicates that the microprocessor is programmed and working
LED4	+3,3 Vdc	Always ON - GREEN	It indicates that the 3,3 Vdc is present
LED5	+5 Vdc	Always ON - GREEN	It indicates that the 5 Vdc is present

6. Using the multimeter in VDC mode perform the tests as indicated in **Test Table 7**. See **Figure 12** for correct tests point location.

Test table 7 – Aux. Power Supply Board Voltage Test

Positive Probe (RED)	Negative Probe (BLACK)	Value
J51 - 2	J53 - 2	+24Vdc/1
J50 - 6	J50 - 4	+565Vdc
J52 - 1	J52 - 4	+24Vdc/2
J53 - 1	J53 - 2	2,5 Vdc (when not in thermal condition)

INVERTER AND OUTPUT BOARD VOLTAGE TEST

WARNING

Service and repair should be performed by only Lincoln Electric factory trained personnel. Unauthorized repairs performed on this equipment may result in danger to the technician or machine operator and will invalidate your factory warranty. For your safety and to avoid electrical shock, please observe all safety notes and precautions detailed throughout this manual. If for any reason you do not understand the test procedures or are unable to perform the test/repairs safely, contact your Local Lincoln Electric Service Department for electrical troubleshooting assistance before you proceed.

.....

TEST DESCRIPTION

This test will determine if the Inverter Board is working.

MATERIALS NEEDED

Multimeter
Machine Wiring Diagram

INVERTER AND OUTPUT BOARD VOLTAGE TEST (continue)

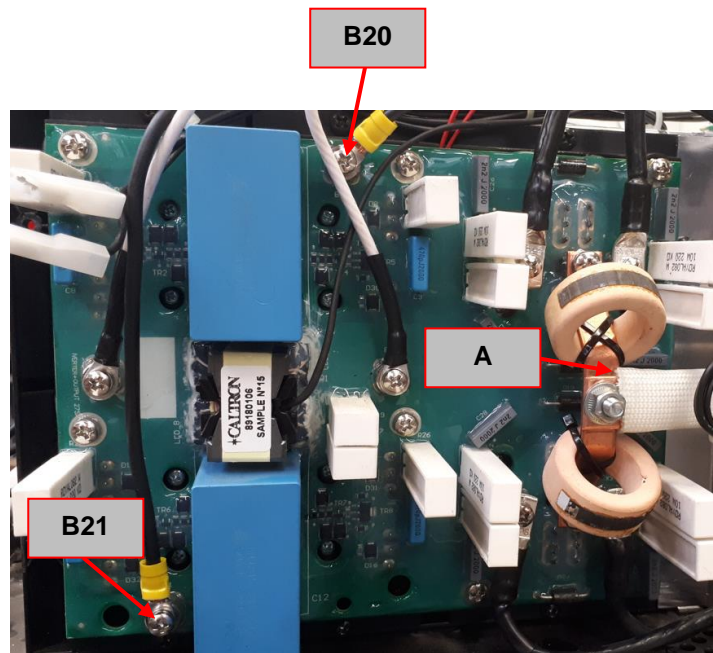

Figure 13 – Inverter Board location and Test Points

TEST PROCEDURE

⚠ Use always electrically insulate gloves during this test procedure

1. Remove main input power to the CITOARC® 275.
2. Perform the **Side Panels removal** and **Discharge procedure** available in this Service Manual
3. Apply 400 Vac +/- 10% to the CITOARC® 275.
4. Switch ON the machine
5. Using the multimeter in VDC mode perform the tests as indicated in **Test Table 8**. See **Figure 13** for correct test points location.

Test table 7 – Inverter and Output Board Voltage Test

Positive Probe (RED)	Negative Probe (BLACK)	Value	Note
B20	B21	+ 565 Vdc	
A	Negative output stud	78 Vdc	Measured with a True RMS multimeter and when the machine is in stick mode

CONTROL BOARD VOLTAGE TEST

WARNING

Service and repair should be performed by only Lincoln Electric factory trained personnel. Unauthorized repairs performed on this equipment may result in danger to the technician or machine operator and will invalidate your factory warranty. For your safety and to avoid electrical shock, please observe all safety notes and precautions detailed throughout this manual. If for any reason you do not understand the test procedures or are unable to perform the test/repairs safely, contact your Local Lincoln Electric Service Department for electrical troubleshooting assistance before you proceed.

.....

TEST DESCRIPTION

This test will determine if the Inverter Board is working.

MATERIALS NEEDED

Multimeter
Machine Wiring Diagram

CONTROL BOARD VOLTAGE TEST (continue)

Figure 14 – Control Board location and Test Points

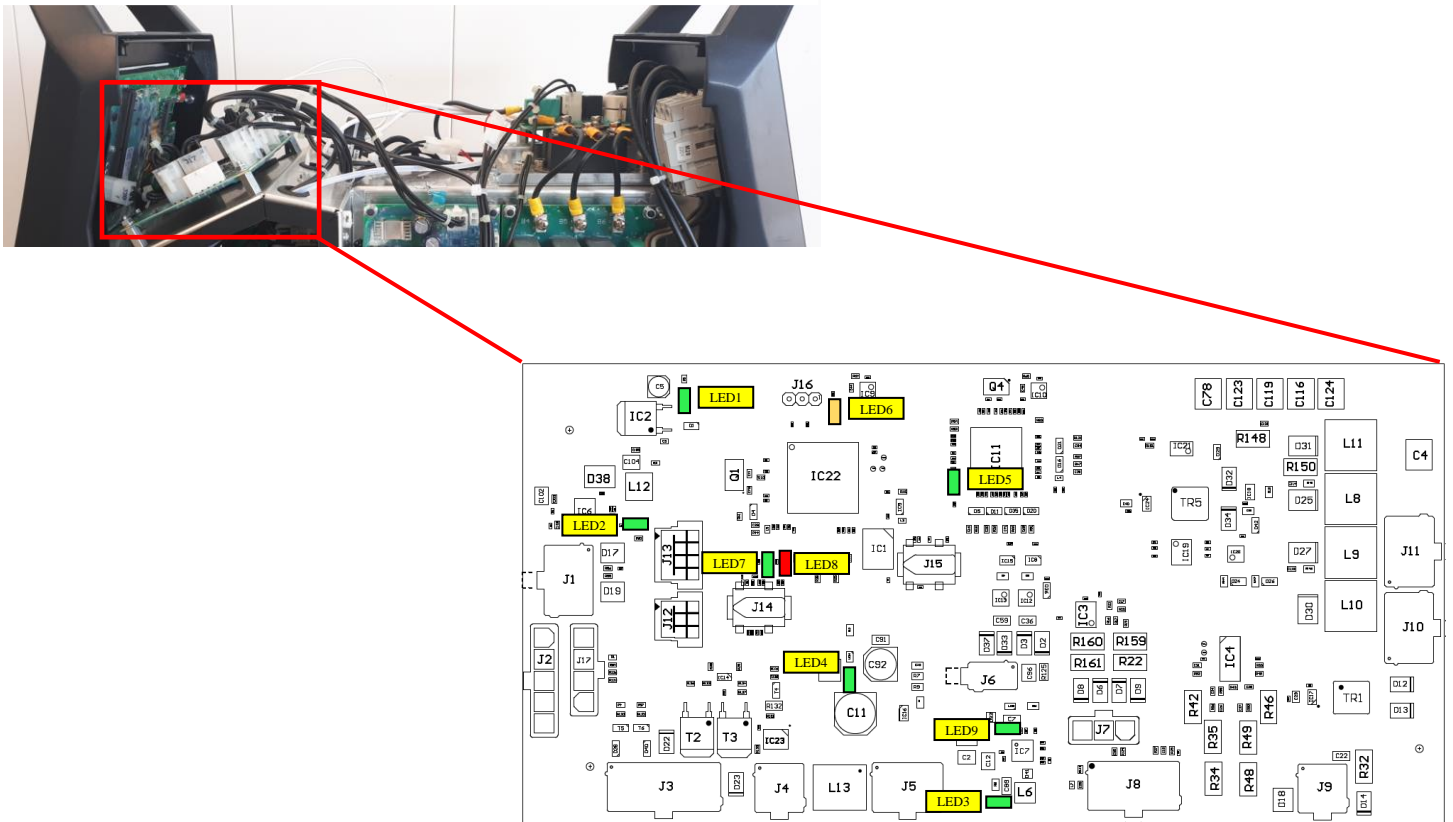

TEST PROCEDURE

⚠ Use always electrically insulate gloves during this test procedure

1. Remove main input power to the CITOARC® 275.
2. Perform the **Side Panels removal** and **Discharge procedure** available in this Service Manual
3. Apply 400 Vac +/- 10% to the CITOARC® 275.
4. Switch ON the machine
5. Check LEDs following the table here below. See **Figure 14** for correct LEDs location.

LEDs Table

LED #	Description	Status	Notes
LED 1	+3,3 Vdc	Always ON - GREEN	It indicates that the 3,3 Vdc is present
LED 2	+ 5Vdc secondary side	Always ON - GREEN	It indicates that the 5Vdc is present
LED 3	-15Vdc	Always ON - GREEN	It indicates that the -15Vdc for current sensor is present
LED 4	+15Vdc	Always ON - GREEN	It indicates that the +15Vdc is present
LED 5	Microprocessor	Always Flashing - GREEN	It indicates that the microprocessor is programmed and working
LED 6	DSP	ON - YELLOW	Only ON when Output is present
LED 7	Microprocessor Heartbeat	Always Flashing - GREEN	It indicates that the microprocessor is programmed and working
LED 8	Error	ALWAYS OFF - RED	Indicates error condition
LED 9	+15Vdc	Always ON - GREEN	It indicates that the +15Vdc for current sensor is present

CONTROL BOARD VOLTAGE TEST (continue)

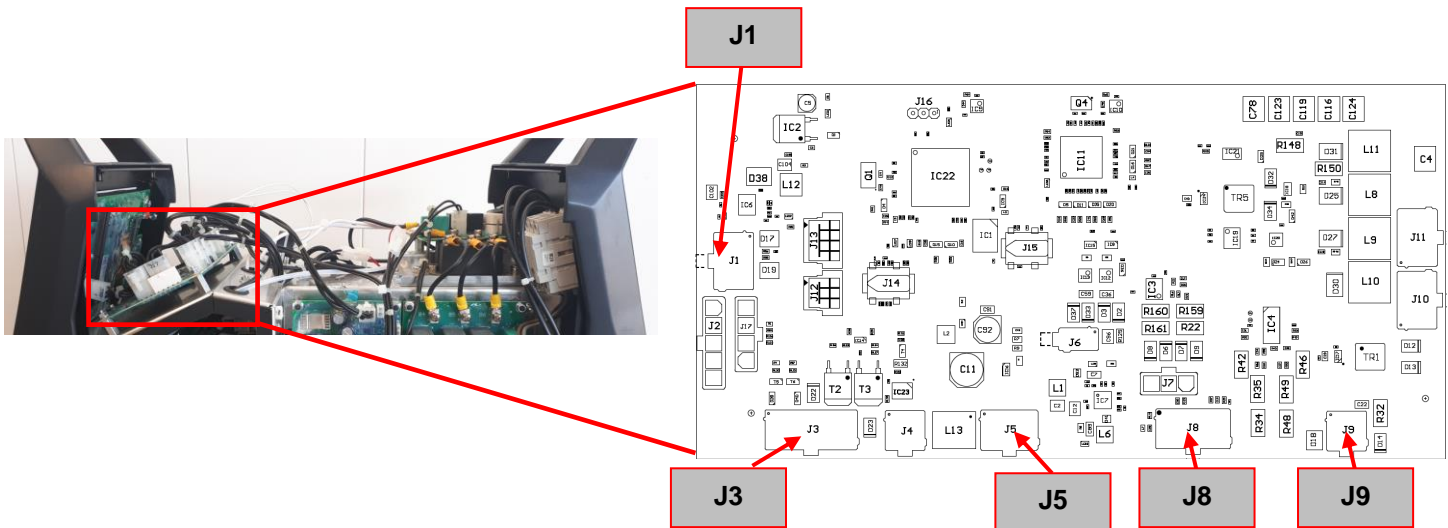

Figure 15 – Control Board location and Test Points

TEST PROCEDURE

⚠ Use always electrically insulate gloves during this test procedure

1. Remove main input power to the CITOARC® 275.
2. Perform the **Side Panels removal** and **Discharge procedure** available in this Service Manual
3. Apply 400 Vac +/- 10% to the CITOARC® 275 and switch ON the machine
4. Using the multimeter in VDC mode perform the tests as indicated in **Test Table 8**. See **Figure 15** for correct test points location.

Test table 8 – Control Board Voltage Test

Positive Probe (RED)	Negative Probe (BLACK)	Value	Note
J1 – 5	J1 – 6	+24Vdc	
J1 – 5	J1 – 4	+5Vdc	
J1 – 5	J1 – 1 / J1 - 2	2,5 Vdc	
J3 – 3	J3 – 8 / J3 - 9	+24 Vdc	Fan Power Supply in stick Mode
J8 – 2	J8 – 5	2,5 -3 Vdc	If no thermal condition is present
J8 – 6	J8 – 4	+15Vdc	Positive Supply for current transducer
J8 – 6	J8 – 3	-15 Vdc	Negative Supply for current transducer
J9 – 2	J9 – 3	78Vdc	OCV in Stick mode. Measured with True RMS multimeter
J5 – 4	J5 – 1	24 Vdc	From Aux. Power Supply Board

DISASSEMBLY OPERATIONS

UPPER AND REAR PLASTIC PANEL REMOVAL PROCEDURE

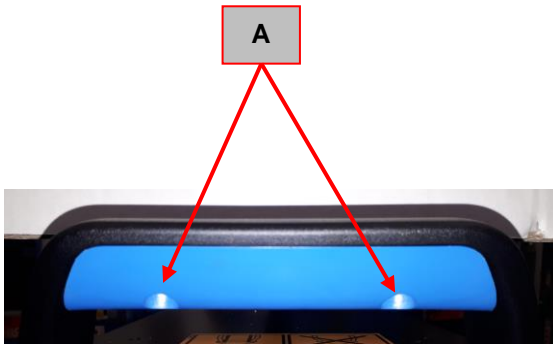
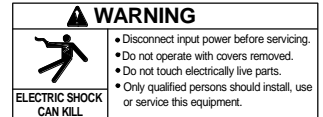

Figure 16

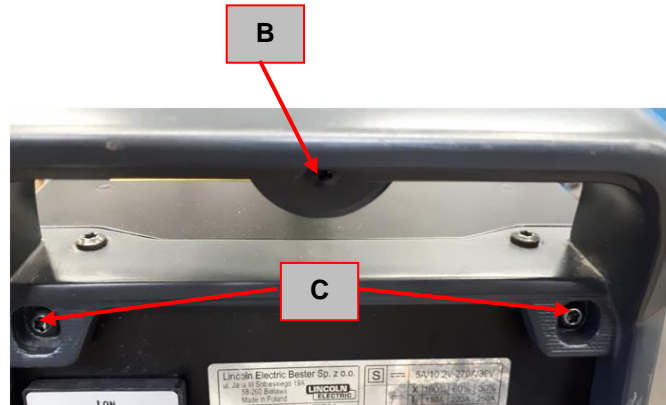

Figure 17

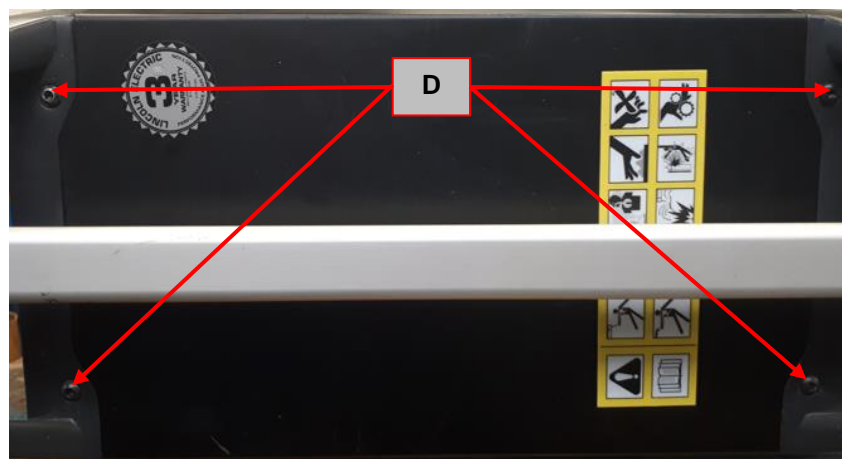

Figure 18

REMOVAL PROCEDURE

Necessary tool:

- Screwdriver type PH02
- Torx 25 wrench

1. Remove main input power to the CITOARC® 275.
2. Perform the **Case Removal** and **Discharge procedure**
3. Locate the two screws (**A**). See **Figure 16**
4. Using screwdriver PH02 remove them and remove the red plastic insert.
5. Using the screwdriver PH02 remove the screw (**B**) that is fixing the metal handle. See **Figure 17**
6. Using the Torx 25 wrench remove the two screws (**C**). See **Figure 17**
7. Using the Torx 25 wrench remove the two screws (**D**). See **Figure 18**
8. Pull gently the rear plastic panel and remove it from the machine.
9. Slide to the backside the upper panel being careful to disconnect the earth wire.
10. **For the re-assembly operations**, make the previous steps in the reverse order

DISASSEMBLY OPERATIONS

EMI FILTER REMOVAL AND REPLACEMENT PROCEDURE

⚠ WARNING	
	<ul style="list-style-type: none">• Disconnect input power before servicing.• Do not operate with covers removed.• Do not touch electrically live parts.• Only qualified persons should install, use or service this equipment.
ELECTRIC SHOCK CAN KILL	



Figure 19

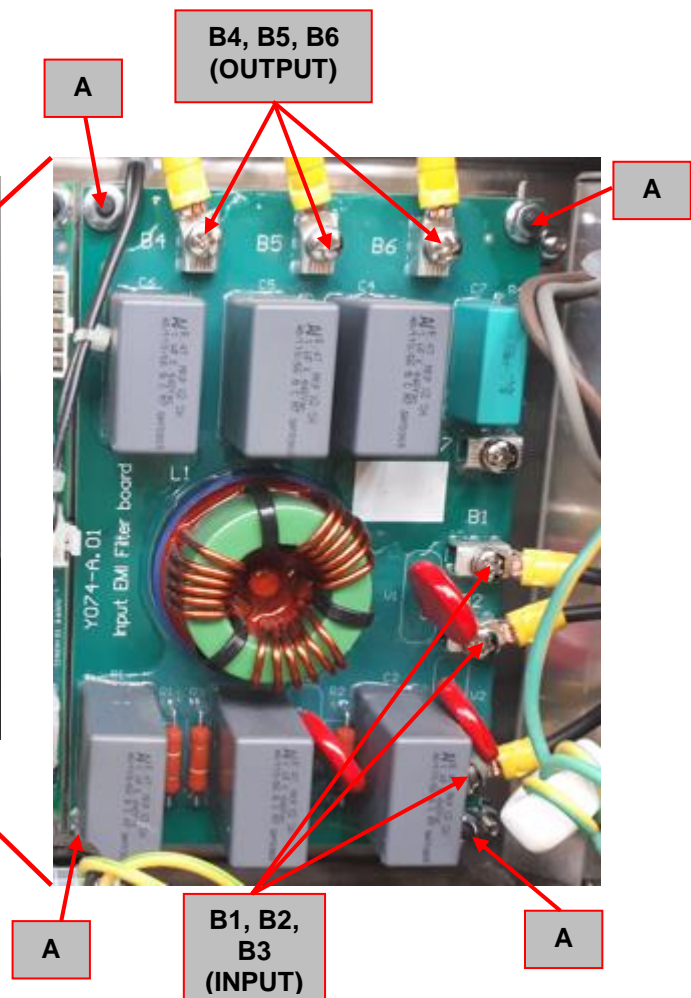

Figure 20

REMOVAL PROCEDURE

Necessary tools:

- Screwdriver PH02
- Socket wrench 7mm

1. Remove main input power to the CITOARC® 275.
2. Perform the **Discharge procedure**.
3. Locate the EMI Board. See **Figure 19**
4. Using the screwdriver PH02 remove the 3 input cables **B1, B2, B3** and the 3 output cables **B4, B5, B6**. See **Figure 20**.
5. Using Socket wrench 7mm remove the 4 EMC board corner bolts (**A**) and carefully remove the EMI Filter Board from the machine.
6. **For the re-assembly operations of EMI board**, make the previous steps in the reverse order

DISASSEMBLY OPERATIONS

PRELOAD BOARD REMOVAL AND REPLACEMENT PROCEDURE

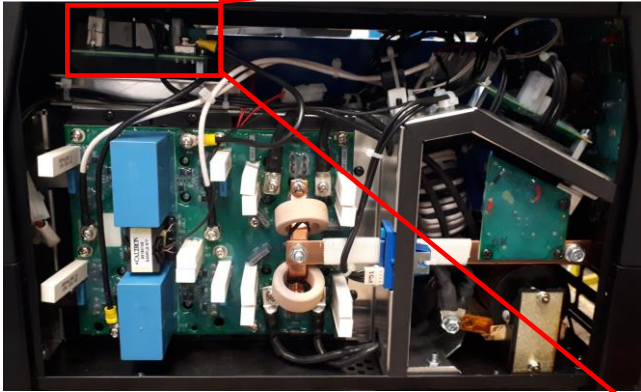

Figure 21

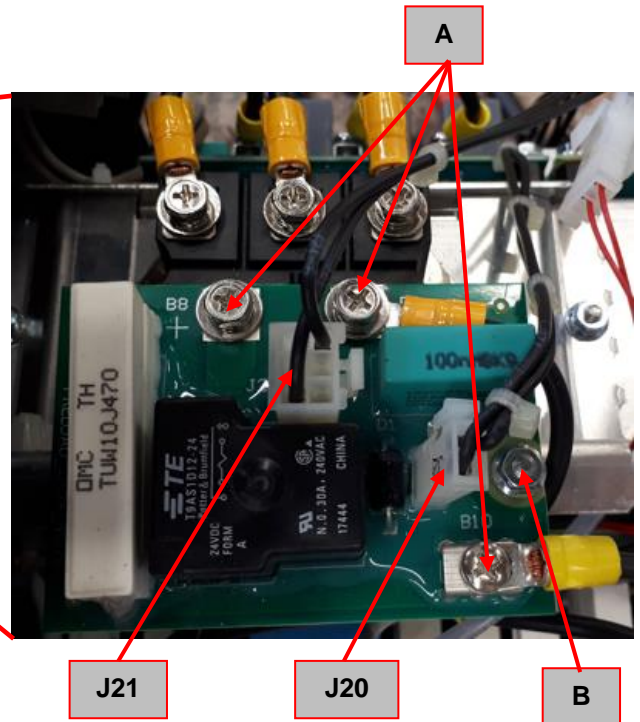

Figure 22

REMOVAL PROCEDURE

Necessary tools:

- Screwdriver PH02
- Socket wrench 7mm

1. Remove main input power to the CITOARC® 275.
2. Perform the **Discharge procedure**.
3. Locate the Preload Board. See **Figure 21**
4. Disconnect the connectors J20 and J21. See **Figure 22**
5. Using the screwdriver PH02 remove the 3 screws (**A**). See **Figure 22**.
6. Using Socket wrench 7mm remove the bolt (**B**). See **Figure 22**.
7. Remove the Preload Board from the machine.
8. **For the re-assembly operations of Preload board**, make the previous steps in the reverse order

DISASSEMBLY OPERATIONS

INPUT RECTIFIER BRIDGE REMOVAL AND REPLACEMENT PROCEDURE

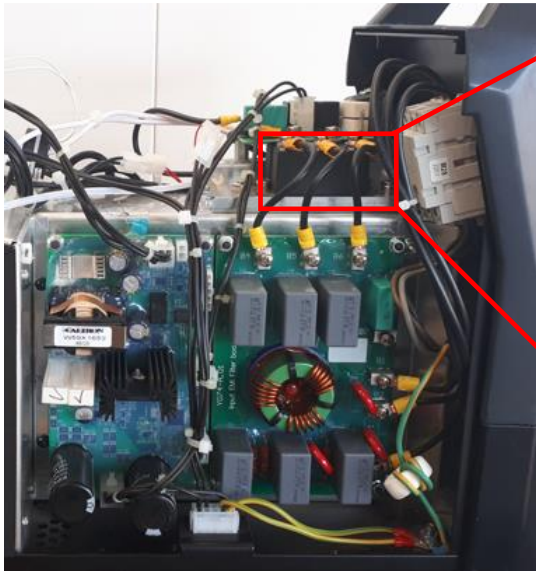

Figure 23

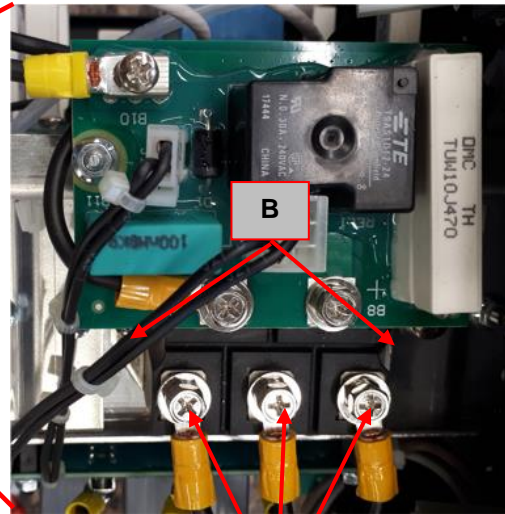

Figure 24

REMOVAL PROCEDURE

Necessary tools:

- Screwdriver PH02

1. Remove main input power to the CITOARC® 275.
2. Perform the **Discharge procedure**.
3. Locate the Input Rectifier Bridge. See **Figure 23**
4. Perform the Preload PCB removal as described into this manual.
5. Using the screwdriver PH02 remove the 3 screws (**A**). See **Figure 24**.
6. Using Socket wrench 7mm remove the 2 screws (**B**) that are fixing the Rectifier Input Bridge to the heat sink. See **Figure 24**.
7. Remove the Rectifier Input Bridge from the machine.

For the re-assembly operations of Preload board, make the previous steps in the reverse order

REASSEMBLY PROCEDURE



1. Clean the heat sink mounting surface from the old thermal compound.
2. Apply a thin layer of new thermal compound (0,1-0,3mm) to the mating surfaces of the new input rectifier bridge (Dow Corning 340)
3. Assemble the new 3 phases input rectifier bridge to the heat sink using the 2 screws (**B**) previously removed (torque 5Nm max.)
4. Assemble the 3 AC input cables and the 2 output cables DC+ and DC- previously removed (torque 3,5Nm max.)

DO NOT USE CORDLESS SCREWDRIVERS FOR THE POWER MODULES!



DISASSEMBLY OPERATIONS

INVERTER AND OUTPUT BOARD REMOVAL AND REPLACEMENT PROCEDURE

	<p>WARNING</p> <ul style="list-style-type: none"> • Disconnect input power before servicing. • Do not operate with covers removed. • Do not touch electrically live parts. • Only qualified persons should install, use or service this equipment.
	<p>ELECTRIC SHOCK CAN KILL</p>

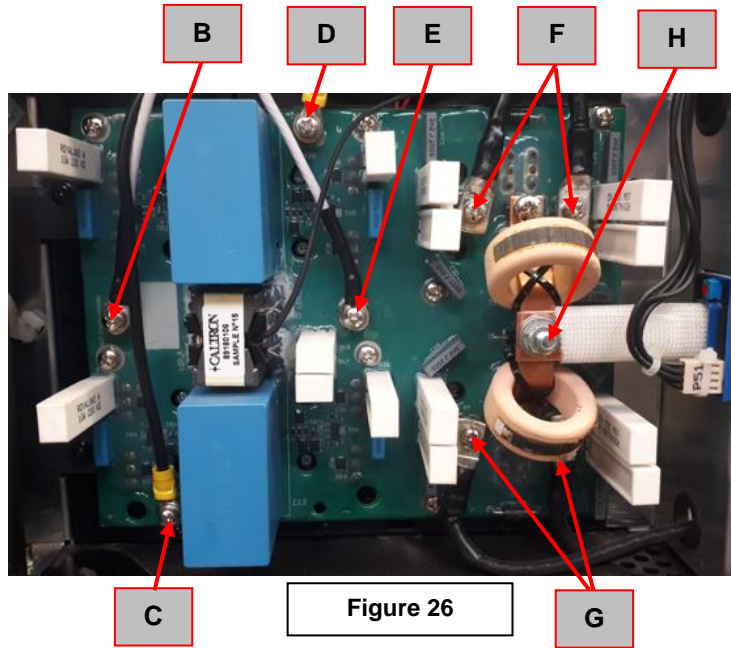

Figure 26

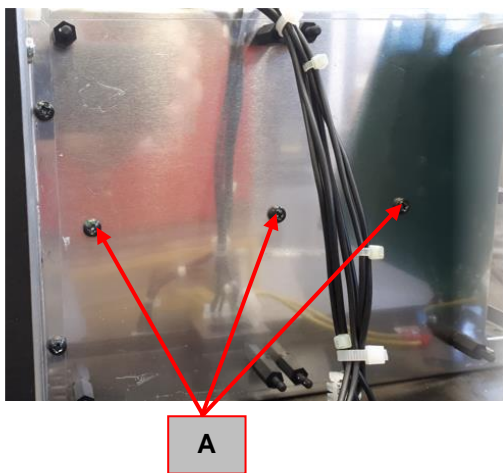

Figure 27

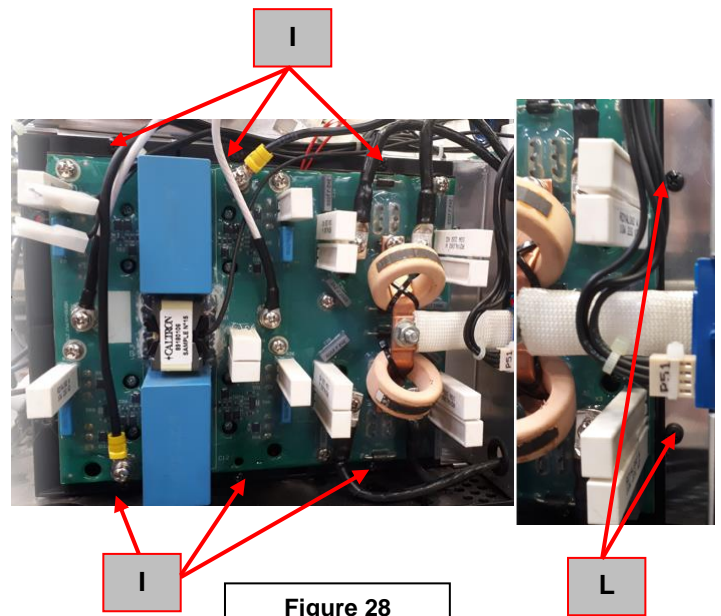

Figure 28

REMOVAL PROCEDURE

Necessary tools:

- Screwdriver PH02
- Socket wrench 10mm

1. Remove main input power to the CITOARC® 275.
2. Perform the **Discharge procedure**.
3. Locate the Inverter and Output Board.
4. Perform, as first step the Fan's, Auxiliary Power Board and EMI filter Board removal procedure available into this service manual
5. Using the PH02 screwdriver remove the three screws (A) that are behind the Aux. Powr and EMI Filter board. See **Figure 27**
6. Using the PH02 screwdriver remove the cables B, C, D, E, F, G. See **Figure 26**
7. Using the Socket wrench 10mm remove the bold (H). Pull a bit the copper bar to be free from the screw. See **Figure 26**.
8. Using the PH02 screwdriver remove the 6 screws (I) and the 2 screws (L). See **Figure 28**
9. Pull the Inverter and Output board and slide it to the back of the machine to remove it.
10. **For the re-assembly operations of Inverter and Output board**, make the previous steps in the reverse order

DISASSEMBLY OPERATIONS

AUXILIARY POWER BOARD REMOVAL AND REPLACEMENT PROCEDURE

	WARNING
	<ul style="list-style-type: none">• Disconnect input power before servicing.• Do not operate with covers removed.• Do not touch electrically live parts.• Only qualified persons should install, use or service this equipment.
ELECTRIC SHOCK CAN KILL	

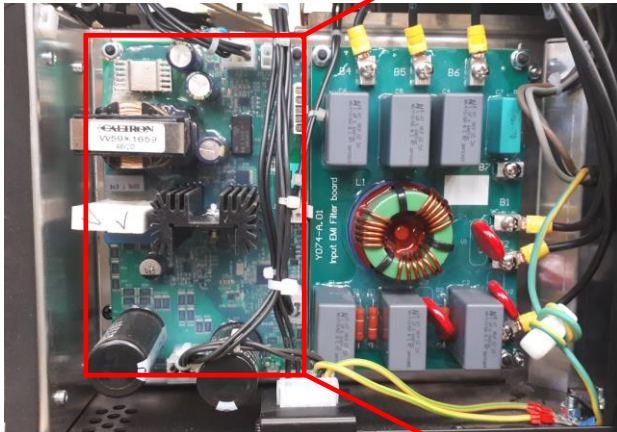

Figure 29

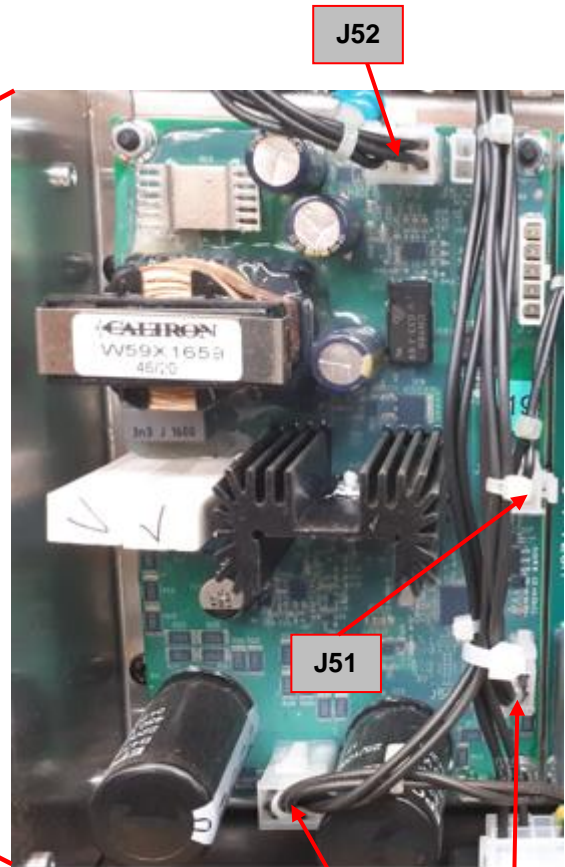

Figure 30

REMOVAL PROCEDURE

Necessary tools:

- Socket wrench 7mm

1. Remove main input power to the CITOARC® 275.
2. Perform the **Discharge procedure**.
3. Locate the Aux. Power Supply Board. See **Figure 29**
4. Remove the 4 connectors **J50, J51, J52, J53**. See **Figure 30**.
5. Using the 7mm socket wrench remove the 4 bolts at the PCB corners. Remove the Aux. Power Board from the machine
6. **For the re-assembly operations of Aux. Power Board**, make the previous steps in the reverse order

DISASSEMBLY OPERATIONS

CONTROL BOARD REMOVAL AND REPLACEMENT PROCEDURE

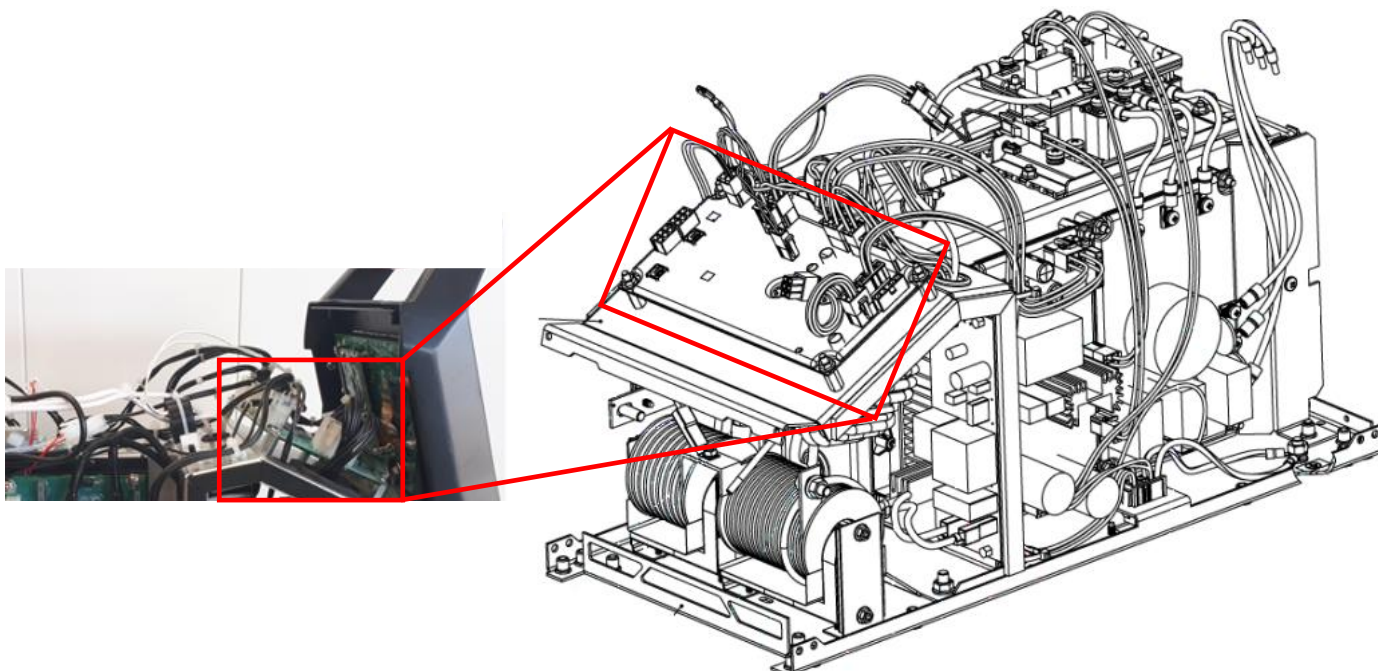

Figure 31

REMOVAL PROCEDURE

Necessary tools:

- Socket wrench 7mm

1. Remove main input power to the CITOARC® 275.
2. Perform the **Discharge procedure**.
3. Locate the Control Board. See **Figure 31**
4. Remove all the connectors **J1, J3, J5, J6, J7, J8, J9, J10**
5. Using the 7 mm socket wrench remove the 4 bolts at the Control PCB corners.
6. Remove the Control Board from the machine
7. **For the re-assembly operations of Control Board**, make the previous steps in the reverse order

DISASSEMBLY OPERATIONS

UI-TFT BOARD REMOVAL AND REPLACEMENT PROCEDURE

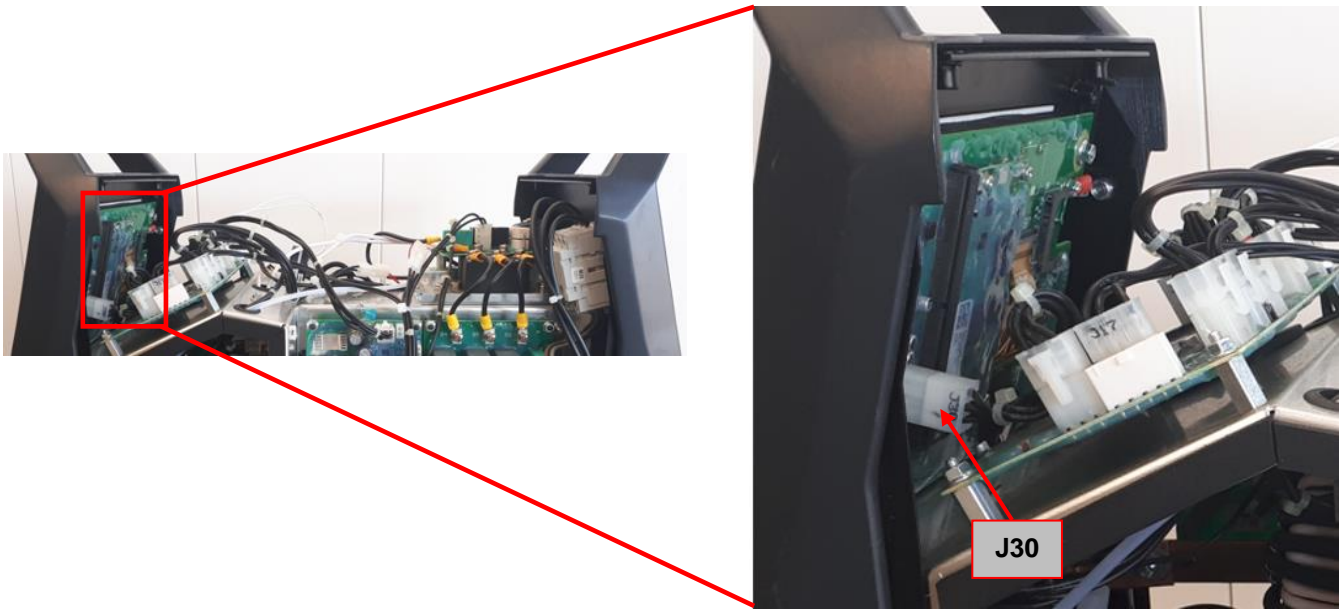

Figure 32



Figure 33



Figure 34

REMOVAL PROCEDURE

Necessary tools:

- 5,5mm wrench
- 2mm allen wrench
- 10mm wrench

1. Remove main input power to the CITOARC® 275.
2. Perform the **Discharge procedure**.
3. Locate the UI TFT Board. See **Figure 32**
4. Using the 2mm allen wrench loosen the allen screw (**A**) that secures the knob and remove it. See **Figure 33**.
5. Using the 10mm wrench remove the bolt (**B**) and the washer that lock the encoder shaft to the front panel. See **Figure 34**.
6. Using the 5,5mm wrench remove the 4 bolts at the corners of the TFT board
7. Pull the TFT board and remove it from the machine
8. **For the re-assembly operations of TFT Board**, make the previous steps in the reverse order

DISASSEMBLY OPERATIONS

ON/OFF SWITCH REMOVAL AND REPLACEMENT PROCEDURE

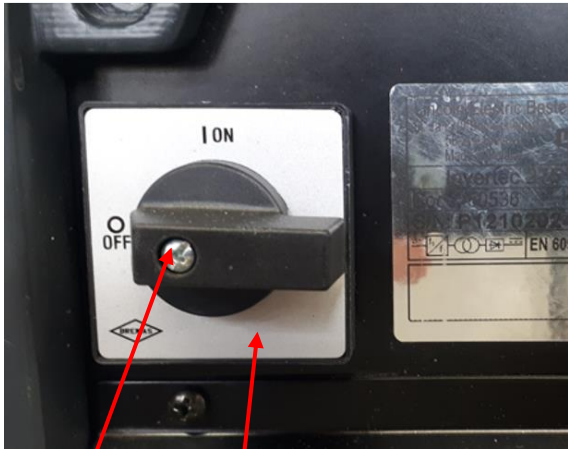

Figure 37

A

B

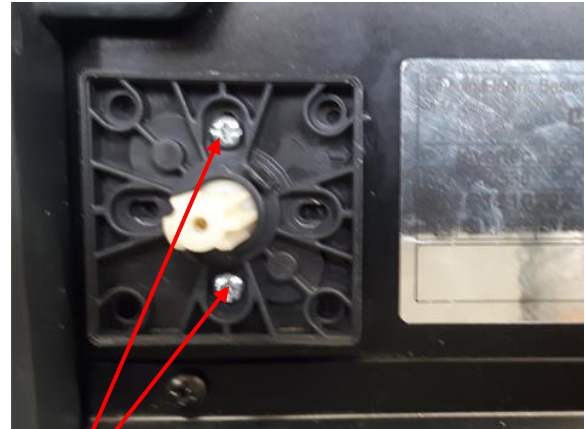

Figure 38

C



Figure 39

REMOVAL PROCEDURE

Necessary tools:

- Screwdriver PH02

1. Remove main input power to the CITOARC® 275.
2. Perform the **Discharge procedure**.
3. Locate the ON/OFF switch on the backside of the machine. See **Figure 37**
4. Using the PH02 screwdriver remove the screw (**A**) and remove the ON/OFF switch knob. See **Figure 37**.
5. Remove the metal plate (**B**) with the serigraphy to access the 2 fixing screws
6. Using the PH02 screwdriver remove the 2 screws (**C**) and remove the black plastic plate. See **Figure 38**.
7. Remove the ON/OFF switch from the rear panel and using a PH02 screwdriver remove the 6 power cables.
8. **For the re-assembly operations of ON/OFF Switch**, make the previous steps in the reverse order

DISASSEMBLY OPERATIONS

FANS REMOVAL AND REPLACEMENT PROCEDURE

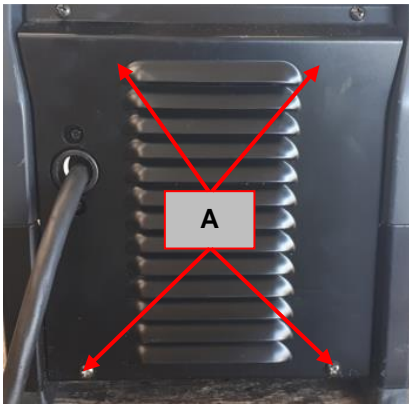

Figure 42

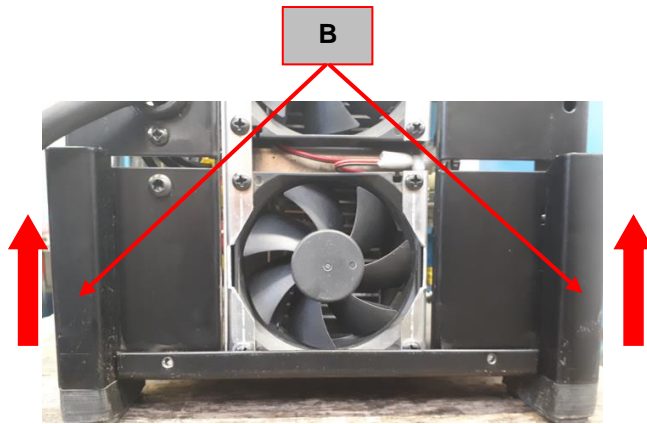

Figure 43

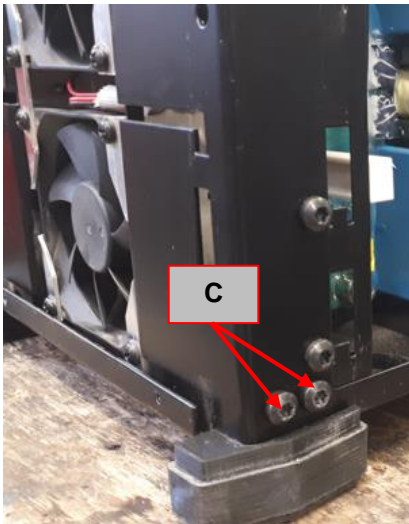

Figure 44

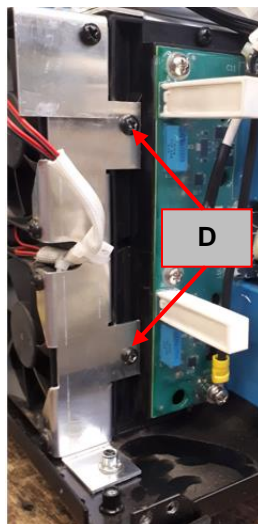

Figure 45

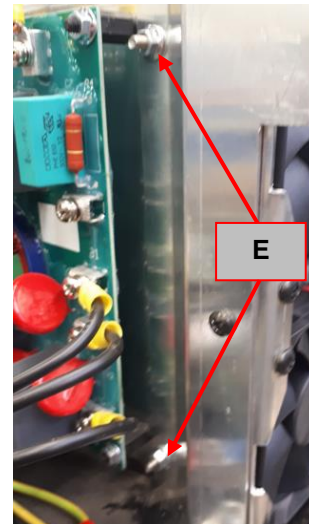

Figure 46

REMOVAL PROCEDURE

Necessary tools:

- PH02 screwdriver
- TX25 wrench
- 7mm wrench

1. Remove main input power to the CITOARC® 275.
2. Perform the **Discharge procedure**.
3. Follow the "UPPER AND REAR PLASTIC PANEL REMOVAL PROCEDURE" available into this manual
4. Using the PH02 screwdriver remove the 4 screws (**A**) that are fixing the fan grid. See **Figure 42**
5. Remove the fan grid
6. Pulling Up by hands the two metal parts (**B**) remove them from the rear panel frame
7. Using the TX25 wrench remove the 2 screws (**C**) on the right side, See **Figure 44**. Do the same on the left side.
8. Using the PH02 screwdriver remove the 2 screws (**D**). See **Figure 45**
9. Using the 7mm wrench remove the 2 bolts (**E**). See **Figure 46**

DISASSEMBLY OPERATIONS

FANS REMOVAL AND REPLACEMENT PROCEDURE (CONTINUE)

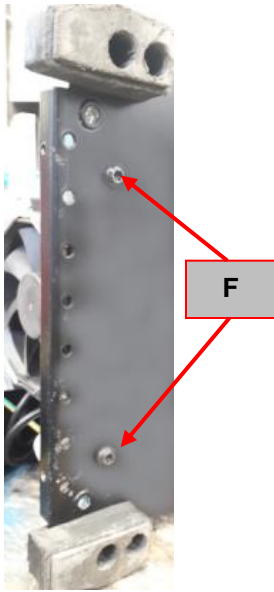

Figure 47

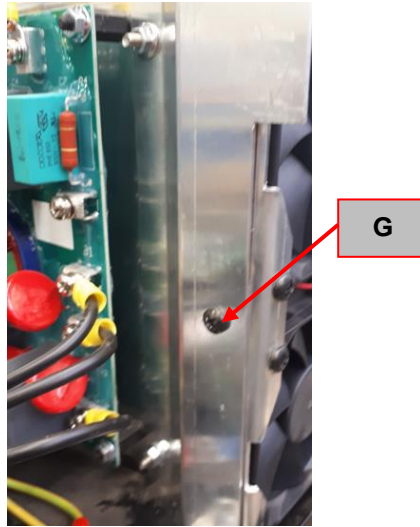

Figure 48

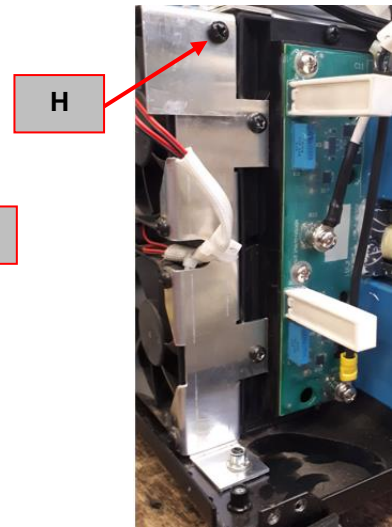

Figure 49

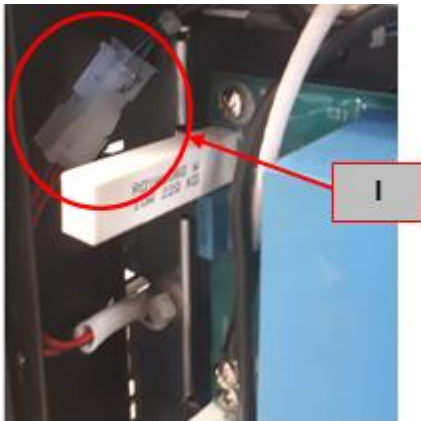

Figure 50

10. Using the TX25 wrench remove the 2 screws (F) on the bottom of the machine, See **Figure 47**
11. Using the PH02 screddriver remove the screw (G). See **Figure 48**
12. Using the PH02 screddriver remove the screw (H). See **Figure 49**
13. Disconnect the fan's power supply connector (I). See **Figure 50**
14. Remove the fan assembly from the machine
15. **For the re-assembly operations of fans assembly, make the previous steps in the reverse order**

RETEST AFTER REPAIR

Should a machine under test be rejected for any reason requiring the removal of any mechanical part that could affect the machine's electrical characteristics, or if any electrical components are repaired or replaced, the machine must be retested.

Machine input and output

CITOARC[®] 275

Input Voltage	Max Input Current	Rated Output	OCV (open circuit voltage) U ₀
400Vac-3ph-50/60Hz	15,3A	Stick Mode 180A/27,2V@100%	70 V

Output Current range	
SMAW	5A - 270A

IMPORTANT !

After the repair, the unit shall be tested accordingly to the norm **EN60974-4 Arc welding equipment "In-service inspection and testing"**

ELECTRICAL SCHEMATICS

Schematic Diagram: CITOARC® 275

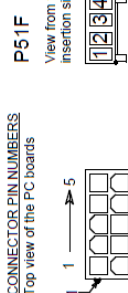
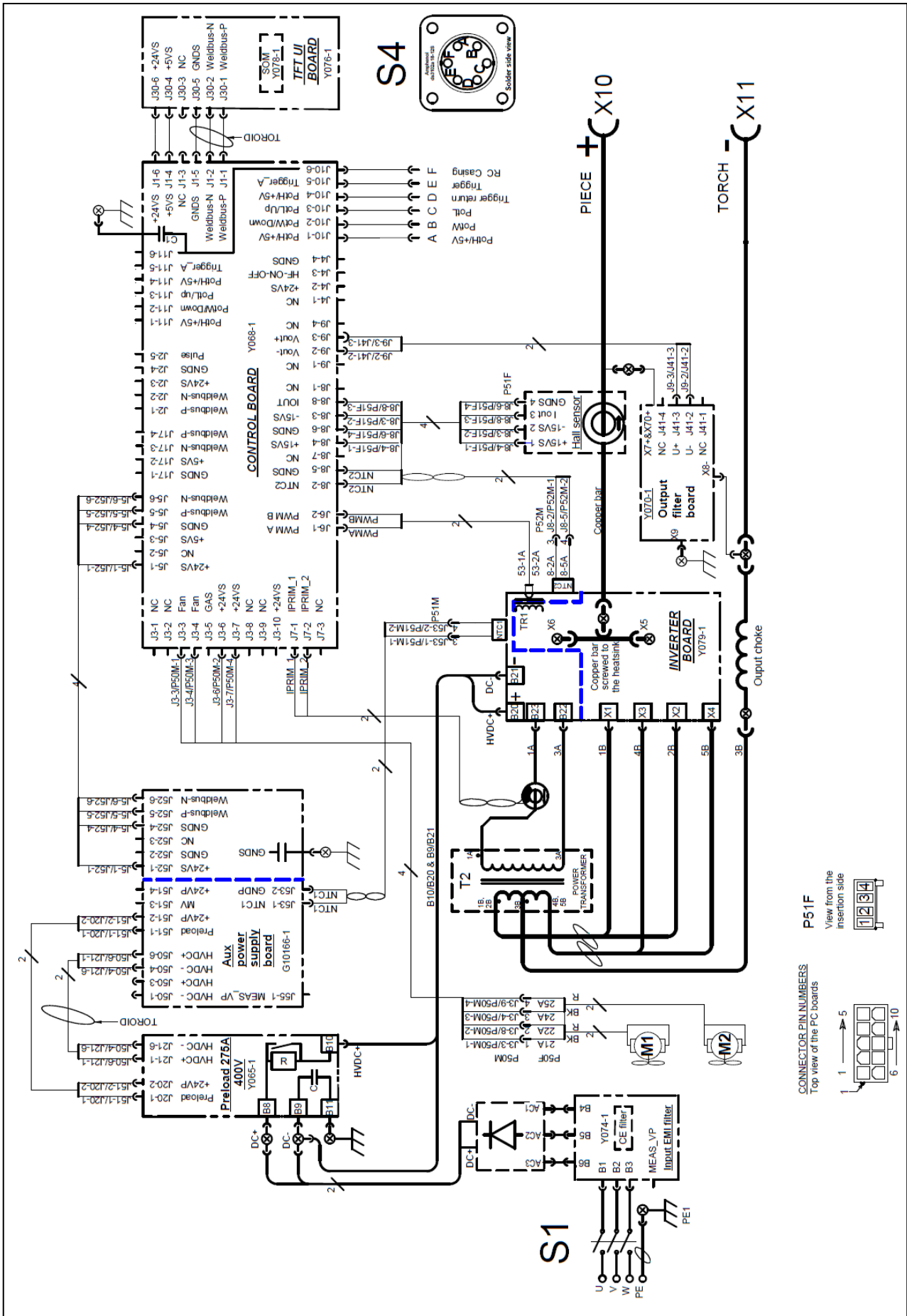

ERROR CODES

Security Description	Manufacturer specific Error code
Primary Over Current	=331
Secondary Over Current (short average)	=46
Secondary current probe failure	=40
Power Supply Over Voltage	=341
Power Supply Under Voltage	=342
Preload Time Out	=337
Primary Over Power	=338
Primary Thermal	=36
Secondary Thermal	=37
Cooler	=266
Calibration Default	=257
Primary Thermal Probe Default	=258
Secondary Thermal Probe Default	=260
Flash Erase Failure	=1119
Flash Program Failure	=1121
Flash Initialization Failure	=1126
Start application or size application error	=1117
Bad Uboot Sequences	=9520
Uboot Final keyword error	=9521
Uboot Wrong CRC	=9522
Uboot Start Application Address write flash failed	=9523
Uboot Length Application write flash failed	=9524
Uboot CRC Application write flash failed	=9525
Uboot launched (cyclic sent before upload)	=1114
Uboot ready to load application	=1115
Watchdog Error	=8121
Control Loop Failure	=8119
Timer 1 or 2 error	=9600
Timer 3 Error	=9601
MAIN_PROGRAM_UNFOUND	=8125
Trigger while default state	=599

