

INVERTEC[®] V320-T AC/DC

OPERATOR'S MANUAL

MANUALE OPERATIVO

BEDIENUNGSANLEITUNG

MANUAL DE INSTRUCCIONES

MANUEL D'UTILISATION

BRUKSANVISNING OG DELELISTE

GEBRUIKSAANWIJZING

BRUKSANVISNING

INSTRUKCJA OBSŁUGI

KÄYTTÖOHJE

MANUAL DE INSTRUÇÕES



LINCOLN[®]
ELECTRIC

Declaration of conformity
Dichiarazione di conformità
Konformitätserklärung
Declaración de conformidad
Déclaration de conformité
Samsvars erklæring
Verklaring van overeenstemming

Försäkran om överensstämmelse
Deklaracja zgodności
Vakuutus yhteensopivuudesta
Declaração de Conformidade

LINCOLN ELECTRIC ITALIA S.r.l.



Declares that the welding machine:
Dichiara che il generatore per saldatura tipo:
Erklärt, daß die Bauart der Maschine:
Declara que el equipo de soldadura:
Déclare que le poste de soudage:
Bekrefter at denne sveisemaskin:
Verklaart dat de volgende lasmachine:

Försäkrar att svetsomriktaren:
Deklaruje, że spawalnicze źródło energii:
Vakuuttaa, että hitsauskone:
Declara que a máquina de soldar:

INVERTEC[®] V320-T AC/DC

conforms to the following directives:
è conforme alle seguenti direttive:
den folgenden Bestimmungen entspricht:
es conforme con las siguientes directivas:
est conforme aux directives suivantes:
er i samsvar med følgende direktiver:
overeenkomt conform de volgende richtlijnen:

överensstämmer med följande direktiv:
spełnia następujące wytyczne:
täyttää seuraavat direktiivit:
está em conformidade com as seguintes directivas:

2006/95/CEE, 2004/108/CEE

and has been designed in compliance with the following standards:
ed è stato progettato in conformità alle seguenti norme:
und in Übereinstimmung mit den nachstehenden normen hergestellt wurde:
y ha sido diseñado de acuerdo con las siguientes normas:
et qu'il a été conçu en conformité avec les normes:
og er produsert og testet iht. følgende standarder:

en is ontworpen conform de volgende normen:
och att den konstruerats i överensstämmelse med följande standarder:
i że zostało zaprojektowane zgodnie z wymaganiami następujących norm:
ja on suunniteltu seuraavien standardien mukaan:
e foi concebida de acordo com as seguintes normas:

EN 60974-1, EN 60974-10

(2009)

Dario Gatti
European Engineering Director Machines
LINCOLN ELECTRIC ITALIA S.r.l., Via Fratelli Canepa 8, 16010 Serra Riccò (GE), Italia

English		<p>Do not dispose of electrical equipment together with normal waste!</p> <p>In observance of European Directive 2002/96/EC on Waste Electrical and Electronic Equipment (WEEE) and its implementation in accordance with national law, electrical equipment that has reached the end of its life must be collected separately and returned to an environmentally compatible recycling facility. As the owner of the equipment, you should get information on approved collection systems from our local representative.</p> <p>By applying this European Directive you will protect the environment and human health!</p>
Italiano		<p>Non gettare le apparecchiature elettriche tra i rifiuti domestici!</p> <p>In ottemperanza alla Direttiva Europea 2002/96/CE sui Rifiuti di Apparecchiature Elettriche ed Elettroniche (RAEE) e la sua attuazione in conformità alle norme nazionali, le apparecchiature elettriche esauste devono essere raccolte separatamente e restituite ad una organizzazione di riciclaggio ecocompatibile. Come proprietario dell'apparecchiatura, Lei potrà ricevere informazioni circa il sistema approvato di raccolta, dal nostro rappresentante locale.</p> <p>Applicando questa Direttiva Europea Lei contribuirà a migliorare l'ambiente e la salute!</p>
Deutsch		<p>Werfen Sie Elektrowerkzeuge nicht in den Hausmüll!</p> <p>Gemäss Europäischer Richtlinie 2002/96/EG über Elektro- und Elektronik- Altgeräte (Waste Electrical and Electronic Equipment, WEEE) und Umsetzung in nationales Recht müssen verbrauchte Elektrowerkzeuge getrennt gesammelt und einer umweltgerechten Wiederverwertung zugeführt werden. Als Eigentümer diese Werkzeuges sollten sie sich Informationen über ein lokales autorisiertes Sammel- bzw. Entsorgungssystem einholen.</p> <p>Mit der Anwendung dieser EU Direktive tragen sie wesentlich zur Schonung der Umwelt und ihrer Gesundheit bei!</p>
Español		<p>No tirar nunca los aparatos eléctricos junto con los residuos en general!</p> <p>De conformidad a la Directiva Europea 2002/96/CE relativa a los Residuos de Equipos Eléctricos o Electrónicos (RAEE) y al acuerdo de la legislación nacional, los equipos eléctricos deberán ser recogidos y reciclados respetando el medioambiente. Como propietario del equipo, deberá informar de los sistemas y lugares apropiados para la recogida de los mismos.</p> <p>Aplicar esta Directiva Europea protegerá el medioambiente y su salud!</p>
Français		<p>Ne pas jeter les appareils électriques avec les déchets ordinaires!</p> <p>Conformément à la Directive Européenne 2002/96/EC relative aux Déchets d' Équipements Électriques ou Électroniques (DEEE), et à sa transposition dans la législation nationale, les appareils électriques doivent être collectés à part et être soumis à un recyclage respectueux de l'environnement. En tant que propriétaire de l'équipement, vous devriez vous informer sur les systèmes de collecte approuvés auprès nos représentants locaux.</p> <p>Appliquer cette Directive Européenne améliorera l'environnement et la santé!</p>
Norsk		<p>Kast ikke elektriske artikler sammen med vanlig søppel.</p> <p>I følge det europeiske direktivet for Elektronisk Søppel og Elektriske Artikler 2002/96/EC (Waste Electrical and Electronic Equipment, WEEE) skal alt avfall kildesorteres og leveres på godkjente plasser i følge loven. Godkjente retur plasser gis av lokale myndigheter.</p> <p>Ved å følge det europeiske direktivet bidrar du til å bevare naturen og den menneskelige helse.</p>
Nederlandse		<p>Gooi elektrische apparatuur nooit bij gewoon afval!</p> <p>Met inachtneming van de Europese Richtlijn 2002/96/EC met betrekking tot Afval van Elektrische en Elektronische Apparatuur (Waste Electrical and Electronic Equipment, WEEE) en de uitvoering daarvan in overeenstemming met nationaal recht, moet elektrische apparatuur, waarvan de levensduur ten einde loopt, apart worden verzameld en worden ingeleverd bij een recycling bedrijf, dat overeenkomstig de milieuwetgeving opereert. Als eigenaar van de apparatuur moet u informatie inwinnen over goedgekeurde verzamelssystemen van onze vertegenwoordiger ter plaatse.</p> <p>Door het toepassen van deze Europese Richtlijn beschermt u het milieu en ieders gezondheid!</p>
Svenska		<p>Släng inte uttjänt elektrisk utrustning tillsammans med annat avfall!</p> <p>Enligt Europadirektiv 2002/96/EC ang. Uttjänt Elektrisk och Elektronisk Utrustning (Waste Electrical and Electronic Equipment, WEEE) och dess implementering enligt nationella lagar, ska elektrisk utrustning som tjänat ut sorteras separat och lämnas till en miljögodkänd återvinningsstation. Som ägare till utrustningen, bör du skaffa information om godkända återvinningsssystem från dina lokala myndigheter.</p> <p>Genom att följa detta Europadirektiv bidrar du till att skydda miljö och hälsa!</p>
Polski		<p>Nie wyrzucać osprzętu elektrycznego razem z normalnymi odpadami!</p> <p>Zgodnie z Dyrektywą Europejską 2002/96/EC dotyczącą Pozbywania się zużytego Sprzętu Elektrycznego i Elektronicznego (Waste Electrical and Electronic Equipment, WEEE) i jej wprowadzeniem w życie zgodnie z międzynarodowym prawem, zużyty sprzęt elektryczny musi być składowany oddzielnie i specjalnie utylizowany. Jako właściciel urządzeń powinniście otrzymać informacje o zatwierdzonym systemie składowania od naszego lokalnego przedstawiciela.</p> <p>Stosując te wytyczne bedziesz chronił środowisko i zdrowie człowieka!</p>
Suomi		<p>Älä hävittää sähkölaitteita sekajätteiden mukana!</p> <p>Noudatettaessa Euroopan Unionin Direktiiviä 2002/96/EY Sähkölaite- ja Elektroniikkajätteestä (WEEE) ja toteutettaessa sitä sopusoinnussa kansallisen lain kanssa, sähkölaite, joka on tullut elinkaarensa päähän pitää kerätä erilleen ja toimittaa sähkö- ja elektroniikkaromujen keräyspisteeseen. Lisätietoja tämän tuotteen käsittelystä, keräämisestä ja kierrätyksestä saa kunnan ympäristöviranomaisilta.</p> <p>Noudattamalla tätä Euroopan Unionin direktiiviä, autat torjumaan kielteiset ympäristö- ja terveysvaikutukset!</p>
Portugués		<p>Não deitar fora o equipamento eléctrico juntamente com o lixo normal!</p> <p>Em conformidade com a directiva Europeia 2002/96/EC relativa a Resíduos Eléctricos e Equipamento Eléctricos (REEE) e de acordo com a legislação nacional, os equipamentos deverão ser recolhidos separadamente e reciclados respeitando o meio ambiente. Como proprietário do equipamento, deverá informar-se dos sistemas e lugares apropriados para a recolha dos mesmos.</p> <p>Ao aplicar esta Directiva Europeia protegerá o meio ambiente e a saúde humana!</p>

<p>THANKS! For having chosen the QUALITY of the Lincoln Electric products.</p> <ul style="list-style-type: none"> • Please Examine Package and Equipment for Damage. Claims for material damaged in shipment must be notified immediately to the dealer. • For future reference record in the table below your equipment identification information. Model Name, Code & Serial Number can be found on the machine rating plate.
<p>GRAZIE! Per aver scelto la QUALITÀ dei prodotti Lincoln Electric.</p> <ul style="list-style-type: none"> • Esamini Imballo ed Equipaggiamento per rilevare eventuali danneggiamenti. Le richieste per materiali danneggiati dal trasporto devono essere immediatamente notificate al rivenditore. • Per ogni futuro riferimento, compilare la tabella sottostante con le informazioni di identificazione equipaggiamento. Modello, Codice (Code) e Matricola (Serial Number) sono reperibili sulla targa dati della macchina.
<p>VIELN DANK! Dass Sie sich für ein QUALITÄTSPRODUKT von Lincoln Electric entschieden haben.</p> <ul style="list-style-type: none"> • Bitte überprüfen Sie die Verpackung und den Inhalt auf Beschädigungen. Transportschäden müssen sofort dem Händler gemeldet werden. • Damit Sie Ihre Gerätedaten im Bedarfsfall schnell zur Hand haben, tragen Sie diese in die untenstehende Tabelle ein. Typenbezeichnung, Code- und Seriennummer finden Sie auf dem Typenschild Ihres Gerätes.
<p>GRACIAS! Por haber escogido los productos de CALIDAD Lincoln Electric.</p> <ul style="list-style-type: none"> • Por favor, examine que el embalaje y el equipo no tengan daños. La reclamación del material dañado en el transporte debe ser notificada inmediatamente al proveedor. • Para un futuro, a continuación encontrará la información que identifica a su equipo. Modelo, Code y Número de Serie los cuales pueden ser localizados en la placa de características de su equipo.
<p>MERCI! Pour avoir choisi la QUALITÉ Lincoln Electric.</p> <ul style="list-style-type: none"> • Vérifiez que ni l'équipement ni son emballage ne sont endommagés. Toute réclamation pour matériel endommagé doit être immédiatement notifiée à votre revendeur. • Notez ci-dessous toutes les informations nécessaires à l'identification de votre équipement. Le nom du Modèle ainsi que les numéros de Code et Série figurent sur la plaque signalétique de la machine.
<p>TAKK! For at du har valgt et KVALITETSPRODUKT fra Lincoln Electric.</p> <ul style="list-style-type: none"> • Kontrollér emballingen og produktet for fejl eller skader. Eventuelle fejl eller transportskader må umiddelbart rapporteres dit du har købt din maskin. • For fremtidig referanse og for garantier og service, fyll ut den tekniske informasjonen nedenfor i dette avsnittet. Modell navn, Kode & Serie nummer finner du på den tekniske platen på maskinen.
<p>BEDANKT! Dat u gekozen heeft voor de KWALITEITSPRODUCTEN van Lincoln Electric.</p> <ul style="list-style-type: none"> • Controleert u de verpakking en apparatuur op beschadiging. Claims over transportschade moeten direct aan de dealer of aan Lincoln electric gemeld worden. • Voor referentie in de toekomst is het verstandig hieronder u machinegegevens over te nemen. Model Naam, Code & Serienummer staan op het typeplaatje van de machine.
<p>TACK! För att ni har valt en KVALITETSPRODUKT från Lincoln Electric.</p> <ul style="list-style-type: none"> • Vänligen kontrollera förpackning och utrustning m.a.p. skador. Transportskador måste omedelbart anmälas till återförsäljaren eller transportören. • Notera informationen om er utrustnings identitet i tabellen nedan. Modellbeteckning, code- och serienummer hittar ni på maskinens märkplåt.
<p>DZIĘKUJEMY! Za docenienie JASKOŚCI produktów Lincoln Electric.</p> <ul style="list-style-type: none"> • Proszę sprawdzić czy opakownie i sprzęt nie są uszkodzone. Reklamacje uszkodzeń powstałych podczas transportu muszą być natychmiast zgłoszone do dostawcy (dystrybutora). • Dla ułatwienia prosimy o zapisanie na tej stronie danych identyfikacyjnych wyrobów. Nazwa modelu, Kod i Numer Seryjny, które możecie Państwo znaleźć na tabliczce znamionowej wyrobu.
<p>KIITOS! Kiitos, että olet valinnut Lincoln Electric LAATU tuotteita.</p> <ul style="list-style-type: none"> • Tarkista pakkaus ja tuotteet vaurioiden varalta. Vaateet mahdollisista kuljetusvaurioista on ilmoitettava välittömästi jälleenmyyjälle. • Tulevaisuutta varten täytä alla oleva lomake laitteen tunnistusta varten. Mallin, Koodin ja Sarjanumeron voit löytää konekilvestä.
<p>OBRIGADO! Por ter escolhido os produtos de QUALIDADE da Lincoln Electric.</p> <ul style="list-style-type: none"> • Por favor, examine a embalagem e o equipamento para que não tenham danos. A reclamação de danos do material no transporte deverá ser notificadas imediatamente ao revendedor. • Para futura referência, registre abaixo a informação de identificação do equipamento. Modelo, Código e Número de Série podem ser encontrados na chapa de características do equipamento.



Model Name, Modello, Typenbezeichnung, Modelo, Nom du modèle, Modell navn, Model Naam, Modellbeteckning, Nazwa modelu, Mallinimi, Modelo:
Code & Serial number, Code (codice) e Matricola, Code- und Seriennummer, Code y Número de Serie, Numéros de Code et Série, Kode & Serie nummer, Code en Seriennummer, Code- och Seriennummer, Kod i numer Seryjny, Koodi ja Sarjanumero, Código e Número de Série:
Date & Where Purchased, Data e Luogo d'acquisto, Kaufdatum und Händler, Fecha y Nombre del Proveedor, Lieu et Date d'acquisition, Kjøps dato og Sted, Datum en Plaats eerste aankoop, Inköpsdatum och Inköpsställe, Data i Mieszce zakupu, Päiväys e Ostopaikka, Data e Local de Compra:



WARNING

This equipment must be used by qualified personnel. Be sure that all installation, operation, maintenance and repair procedures are performed only by qualified person. Read and understand this manual before operating this equipment. Failure to follow the instructions in this manual could cause serious personal injury, loss of life, or damage to this equipment. Read and understand the following explanations of the warning symbols. Lincoln Electric is not responsible for damages caused by improper installation, improper care or abnormal operation.

	<p>WARNING: This symbol indicates that instructions must be followed to avoid serious personal injury, loss of life, or damage to this equipment. Protect yourself and others from possible serious injury or death.</p>
	<p>READ AND UNDERSTAND INSTRUCTIONS: Read and understand this manual before operating this equipment. Arc welding can be hazardous. Failure to follow the instructions in this manual could cause serious personal injury, loss of life, or damage to this equipment.</p>
	<p>ELECTRIC SHOCK CAN KILL: Welding equipment generates high voltages. Do not touch the electrode, work clamp, or connected work pieces when this equipment is on. Insulate yourself from the electrode, work clamp, and connected work pieces.</p>
	<p>ELECTRICALLY POWERED EQUIPMENT: Turn off input power using the disconnect switch at the fuse box before working on this equipment. Ground this equipment in accordance with local electrical regulations.</p>
	<p>ELECTRICALLY POWERED EQUIPMENT: Regularly inspect the input, electrode, and work clamp cables. If any insulation damage exists replace the cable immediately. Do not place the electrode holder directly on the welding table or any other surface in contact with the work clamp to avoid the risk of accidental arc ignition.</p>
	<p>ELECTRIC AND MAGNETIC FIELDS MAY BE DANGEROUS: Electric current flowing through any conductor creates electric and magnetic fields (EMF). EMF fields may interfere with some pacemakers, and welders having a pacemaker shall consult their physician before operating this equipment.</p>
	<p>CE COMPLIANCE: This equipment complies with the European Community Directives.</p>
	<p>FUMES AND GASES CAN BE DANGEROUS: Welding may produce fumes and gases hazardous to health. Avoid breathing these fumes and gases. To avoid these dangers the operator must use enough ventilation or exhaust to keep fumes and gases away from the breathing zone.</p>
	<p>ARC RAYS CAN BURN: Use a shield with the proper filter and cover plates to protect your eyes from sparks and the rays of the arc when welding or observing. Use suitable clothing made from durable flame-resistant material to protect you skin and that of your helpers. Protect other nearby personnel with suitable, non-flammable screening and warn them not to watch the arc nor expose themselves to the arc.</p>
	<p>WELDING SPARKS CAN CAUSE FIRE OR EXPLOSION: Remove fire hazards from the welding area and have a fire extinguisher readily available. Welding sparks and hot materials from the welding process can easily go through small cracks and openings to adjacent areas. Do not weld on any tanks, drums, containers, or material until the proper steps have been taken to insure that no flammable or toxic vapors will be present. Never operate this equipment when flammable gases, vapors or liquid combustibles are present.</p>
	<p>WELDED MATERIALS CAN BURN: Welding generates a large amount of heat. Hot surfaces and materials in work area can cause serious burns. Use gloves and pliers when touching or moving materials in the work area.</p>
	<p>SAFETY MARK: This equipment is suitable for supplying power for welding operations carried out in an environment with increased hazard of electric shock.</p>

	EQUIPMENT WEIGHT OVER 30kg: Move this equipment with care and with the help of another person. Lifting may be dangerous for your physical health.
	CYLINDER MAY EXPLODE IF DAMAGED: Use only compressed gas cylinders containing the correct shielding gas for the process used and properly operating regulators designed for the gas and pressure used. Always keep cylinders in an upright position securely chained to a fixed support. Do not move or transport gas cylinders with the protection cap removed. Do not allow the electrode, electrode holder, work clamp or any other electrically live part to touch a gas cylinder. Gas cylinders must be located away from areas where they may be subjected to physical damage or the welding process including sparks and heat sources.
HF	CAUTION: The high frequency used for contact-free ignition with TIG (GTAW) welding, can interfere with the operation of insufficiently shielded computer equipment, EDP centers and industrial robots, even causing complete system breakdown. TIG (GTAW) welding may interfere with electronic telephone networks and with radio and TV reception.

Installation and Operator Instructions

Read this entire section before installation or operation of the machine.

Location and Environment

This machine will operate in harsh environments. However, it is important that simple preventative measures are followed to assure long life and reliable operation.

- Do not place or operate this machine on a surface with an incline greater than 15° from horizontal.
- Do not use this machine for pipe thawing.
- This machine must be located where there is free circulation of clean air without restrictions for air movement to and from the air vents. Do not cover the machine with paper, cloth or rags when switched on.
- Dirt and dust that can be drawn into the machine should be kept to a minimum.
- This machine has a protection rating of IP23S. Keep it dry when possible and do not place it on wet ground or in puddles.
- Locate the machine away from radio controlled machinery. Normal operation may adversely affect the operation of nearby radio controlled machinery, which may result in injury or equipment damage. Read the section on electromagnetic compatibility in this manual.
- Do not operate in areas with an ambient temperature greater than 40°C.

Input Supply Connection

Check the input voltage, phase, and frequency supplied to this machine before turning it on. The allowable input voltage is indicated in the technical specification section of this manual and on the rating plate of the machine. Verify the connection of grounding wires from the machine to the input source.

Make sure the amount of power available from the input connection is adequate for normal operation of the machine. The necessary fuse and cable sizes are indicated in the technical specification section of this manual.

The V320-T AC/DC is machine is designed to operate on engine driven generators as long as the Vac auxiliary can supply adequate power as indicated in the technical

specification section of this manual. The auxiliary supply of the generator must also meet the following conditions.

- The AC waveform peak voltage is below 620V.
- The AC waveform frequency is between 50 and 60 Hz.
- The RMS voltage of the AC waveform is always equal to 230/400Vac ±10%.

It is important to check these conditions because many engine driven generators produce high voltage spikes. Operation of this machine on engine driven generators not conforming to these conditions is not recommended and may damage the machine.

Output Connections

A quick disconnect system using Twist-Mate cable plugs is used for the welding cable connections. Refer to the following sections for more information on connecting the machine for operation of stick welding (MMA) or TIG welding (GTAW).

Stick Welding (MMA)

First determine the proper electrode polarity for the electrode to be used. Consult the electrode data for this information. Then connect the output cables to the output terminals of the machine for the selected polarity. For example, if DC(+) welding will be used then connect the electrode cable to the (+) terminal of the machine and the work clamp to the (-) terminal. Insert the connector with the key lining up with the keyway and rotate approximately ¼ turn clockwise. Do not over tighten.

For DC(-) welding switch the cable connections at the machine so that the electrode cable is connected to (-) and the work clamp is connected to (+).

TIG Welding (GTAW)

This machine does not include a TIG torch necessary for TIG welding, but one may be purchased separately. Refer to the accessories section for more information. Connect the torch cable to the (-) terminal of the machine and the work clamp to the (+) terminal. Insert the connector with the key lining up with the keyway and rotate approximately ¼ turn clockwise. Do not over tighten.

Connect the gas hose from the TIG torch to the gas connector (B) on the front of the machine. If necessary, an extra gas connector for the fitting on the front of the machine is included in the package. Next, connect the fitting on the back of the machine to a gas regulator on the cylinder of gas to be used. An input gas line and the required fittings are also included in the package. Connect the TIG torch trigger to the trigger connector (A) on the front of the machine. Connect the water hoses to the water connectors on the front of the Coolarc if the machine is completed with a Coolarc water-cooler.

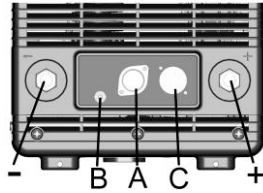

Remote Control Connection

Refer to the accessories section for a list of remote controls. If a remote control is used, it will be connected to the remote connector (C) on the front of the machine.

Optional COOL-ARC 34 Water Cooler

The optional Cool-Arc 34 water cooler is designed to operate in communication with the V320-T AC/DC. Refer to the Cool-Arc 34 operator manual for installation instructions and a complete description of its operation.

When the V320-T AC/DC is powered ON the water cooler Cool-Arc 34 will automatically power ON as well.

Rear Control Panel

⚠ WARNING

I1: Off/On switch turns on the electric power to the welder. It has two positions, "O" off, and "I" on.

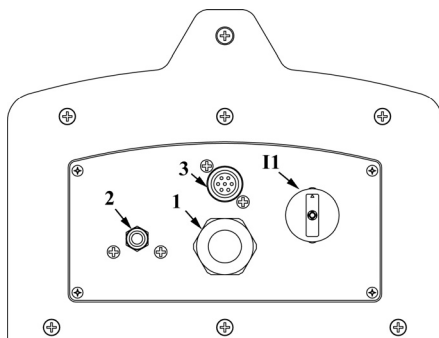

1. Supply cable.
2. Gas attachment.
3. Connector: ⚠ SERVICE purposes only.
- I1: Power Switch.

- With "I1" in the "I"(ON) position, the welding machine is operational and there is voltage between the positive (+) and negative (-) Terminals in stick welding. In TIG, the welding process needs a trigger closure command at the remote control connection (Usually via an Arc Start Switch or Foot Amptrrol).
- The welder is connected to the supply even if the "I1" (Power Switch) is in the "O" (Off) position, and therefore there are electrically live parts inside the power source. Carefully follow the instructions given in this manual.

User Interface Overview and Operation

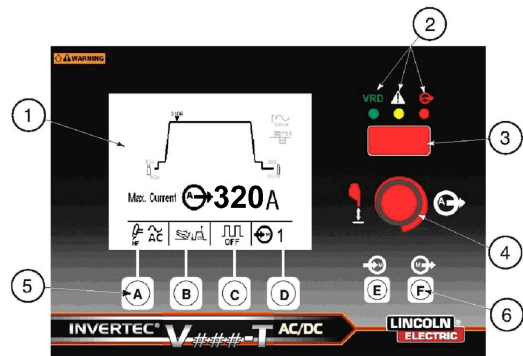

Figure B.3

The V320-T AC/DC User interface consists of the following (Refer to Figure B.3):

1. **Dynamic LCD Display**
2. **Status LED Lights**
 - a) VRD On (Voltage Reduction Device) - If the voltage reduction device is enabled from the setup menu this green LED will illuminate when the open circuit voltage is present at the output terminals and held below the VRD threshold limit. If the VRD is disabled or the unit is welding, it will not illuminate.
 - b) General Alarm - Yellow LED which is lit when faults exist with the power source or optional cooler, such as over temperature, coolant blockage, etc.
 - c) Output On (No VRD) - This status light will illuminate red whenever the output in electrically hot and the voltage level is above the VRD threshold value.
3. **7-segment LED display (H)**
4. **Push button / Rotary Encoder**
5. **Mode Push buttons (A-D)**
 - a) Weld Mode (A)
 - b) Trigger Mode (B)
 - c) TIG Pulse Mode (C)
 - d) Memory Location Select (D)
6. **Push buttons (E, F)**
 - e) Memory Save (E)
 - f) Memory Recall (F)

Dynamic LCD Display

The Dynamic display is divided into several sections (Refer to Figure B.4):

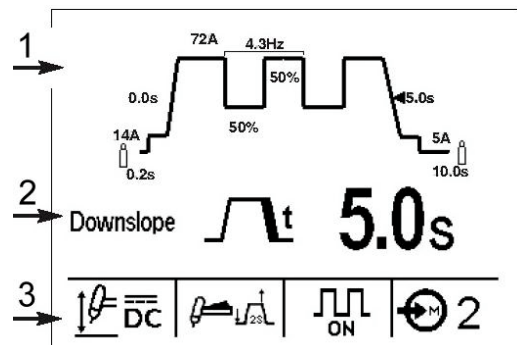

Figure B.4

1. Weld Sequence Diagram
2. Parameter Display
3. Mode Push Button Indicators

1. The **Weld Sequence Diagram** shows the various parameters that can be selected and adjusted and their preset values. As the push button/rotary encoder is pressed a triangular shaped flashing indicator will highlight the adjustable parameter on the sequence diagram in bold. Each press of the encoder will scroll to the next selected parameter sequentially. Rotating the push button encoder will change the selected parameter value. The display is dynamic in that adjusting the selected parameter dynamically changes the shape of the sequence diagram. After 5 seconds of inactivity the selected parameter will default back to the weld Output Amperes parameter. Depressing the button again will remember the last selected parameter and begin the sequential scroll from that parameter.

Three Sequence Diagram types exist:

- STICK (See Figure B.4a)
- TIG (See Figure B.4b)
- Pulse TIG (See Figure B.4c)

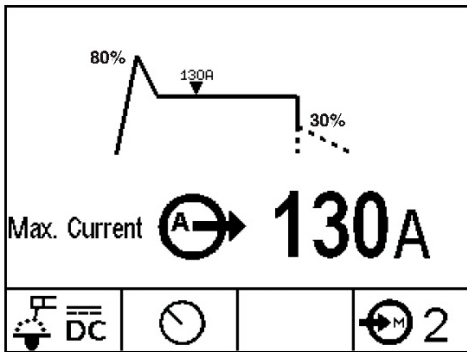

Figure B.4a

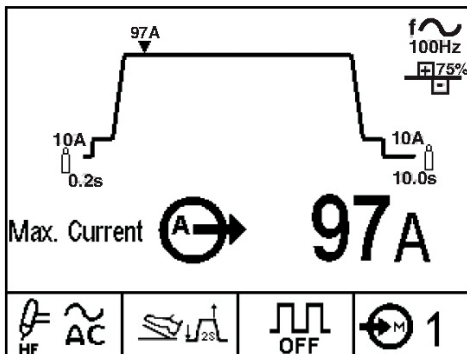

Figure B.4b

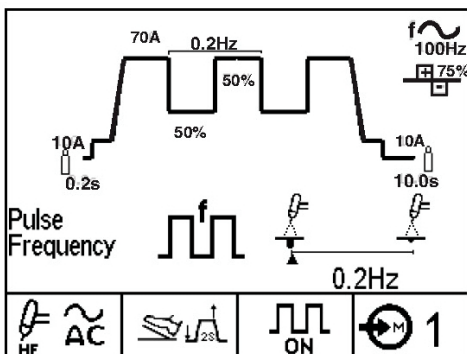

Figure B.4c

2. The **Parameter Display Section** shows the selected parameter its display icon and preset value. To change the value, rotate the push button/rotary encoder. Some parameters like AC Frequency have an Enhanced Icon Display that shows the effect of the varying parameter on the arc and/or weld bead profile. As these parameters are adjusted an indicator will move between the minimum and maximum icon to show the relative effect of that parameter. Pulse Frequency shown in Figure B.4c is an example of the enhanced icon display. Refer to Table B.1 for a list of Enhanced Icons.

Parameter	Symbol	
	Minimum	Maximum
f~ Ac Frequency		
+ Ac Balance		
f Pulse Frequency		
Hot Start		
Arc Force		

Table B.1

3. The **Mode Push Buttons and Indicators** show the current selection made by the corresponding weld push buttons (A-F). Refer to Table B.2 for a full list of all parameters and their ranges. Below is a description of the function of each push button and display:

Push button A: Welding Modes

	DC TIG - DC TIG welding with high frequency arc initiation.
	AC TIG - AC TIG welding with high frequency arc initiation.
	DC Touch Start TIG - DC TIG welding with lift tig arc initiation.
	Stick crisp mode - for Cellulosic electrodes like Exx10.
	Stick soft mode - for E7018 Low Hydrogen electrodes.
	AC Stick Mode - for AC Stick Electrodes.

Table B.2

Push button B: Trigger Modes TIG Trigger Sequences

TIG welding can be done in either the 2-step or 4-step mode. The specific sequences of operation for these two trigger modes are explained below.

2-Step TIG Sequence

With the 2-step trigger mode and a TIG welding mode selected, the following welding sequence will occur.

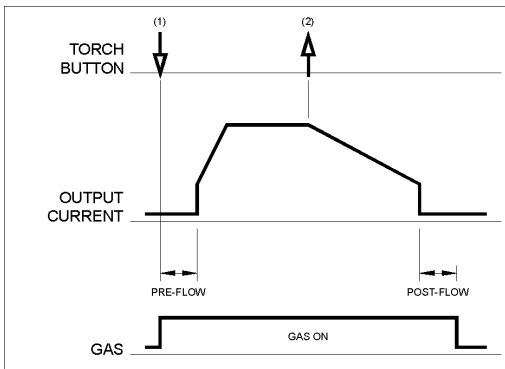

1. Press and hold the TIG torch trigger to start the sequence. The machine will open the gas valve to start the flow of the shielding gas. After the preflow time, to purge air from the torch hose, the output of the machine is turned ON. At this time the arc is started according to the selected welding mode. After the arc is started the output current will be increased at a controlled rate, or upslope time, until the Welding current is reached.
2. Release the TIG torch trigger to stop welding. The machine will now decrease the output current at a controlled rate, or downslope time, until the Crater current is reached and the output of the machine is turned OFF.

After the arc is turned OFF, the gas valve will remain open to continue the flow of the shielding gas to the hot electrode and work piece.

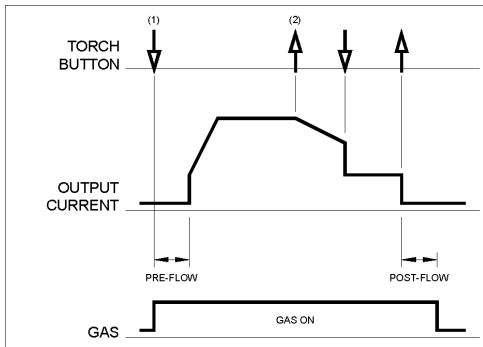

As shown above, it is possible to press and hold the TIG torch trigger a second time during downslope to end the downslope function and maintain the output current at the Crater current. When the TIG torch trigger is released the output will turn OFF and the postflow time will start. This operation, 2-step restart disabled, is the default setting from the factory.

4-Step Sequence

With the 4-step trigger mode and a TIG welding mode selected, the following welding sequence will occur.

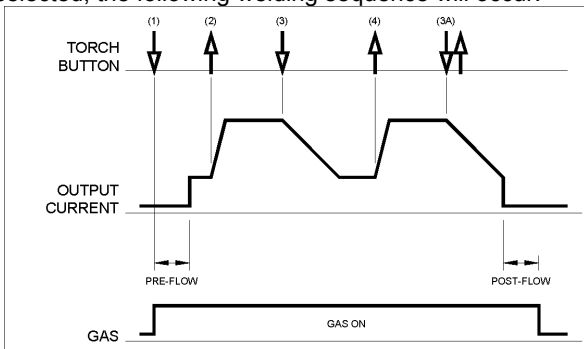

1. Press and hold the TIG torch trigger to start the sequence. The machine will open the gas valve to start the flow of the shielding gas. After the preflow time, to purge air from the torch hose, the output of the machine is turned ON. At this time the arc is started according to the selected welding mode. After the arc is started the output current will be at the Start current. This condition can be maintained as long or as short as necessary.

If the Start current is not necessary, do not hold the TIG torch trigger as described at the beginning of this step. In this condition, the machine will pass from Step 1 to Step 2 when the arc is started.

2. Releasing the TIG torch trigger starts the upslope function. The output current will be increased at a controlled rate, or upslope time, until the Welding current is reached.
3. Press and hold the TIG torch trigger when the main part of the weld is complete. The machine will now decrease the output current at a controlled rate, or downslope time, until the Crater current is reached. This Crater current can be maintained as long or as short as necessary.

This sequence has an automatic restart so welding will continue after this step. This operation, 4-step restart enabled, is the default setting from the factory. If the weld is completely finished, use the following sequence instead of step 3 described above.

- 3A. Quickly press and release the TIG torch trigger. The machine will now decrease the output current at a controlled rate, or downslope time, until the Crater current is reached and the output of the machine is turned OFF. After the arc is turned OFF the postflow time will start.

4. Release the TIG torch trigger. The output current will again increase to the Welding current, like in step 2, to continue welding. When the main part of the weld is complete go to step 3.

As shown here, after the TIG torch trigger is quickly pressed and released from step 3A, it is possible to press and hold the TIG torch trigger another time to end the downslope time and maintain the output current at the Crater current. When the TIG torch trigger is released the output will again increase to the Welding current, like in step 4, to continue welding.

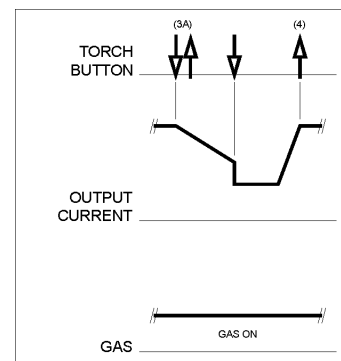

When the main part of the weld is complete go to step 3.

As shown here, again after the TIG torch trigger is quickly pressed and released from step 3A, it is possible to quickly press and release the TIG torch trigger a second time to end the downslope time and stop welding.

04/03

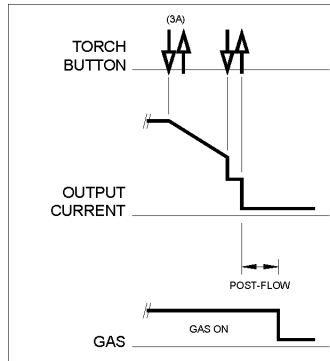

Push button D, E & F: Memory Operation

Pressing and releasing the memory location (D) button will scroll through memory locations 1 through 10. When a memory is recalled or saved the memory location display will change to reversed text indicating that the current memory parameters are active.

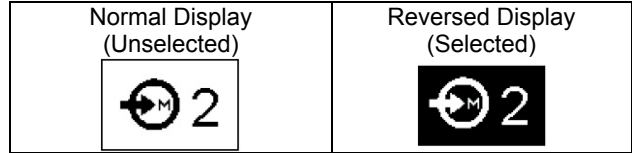

	<p>Bi-Level Current - (If Enabled from the Setup Menu) Depressing an arc start switch and releasing will initiate the arc to current level A1. Depressing and releasing the arc Start switch again will toggle to current level A2. Each depressing and releasing of the switch will toggle between A1 and A2. Depressing and holding the switch in will initiate the down-slope to the finish current level and finally releasing the trigger will extinguish the arc.</p>
	<p>Spot Timer -(If Enabled from the Setup Menu) Selecting this trigger mode will enable a spot timer parameter setting to be displayed as a welding parameter. Once the arc is established the machine will weld for the time period set by the spot timer parameter setting. The machine will follow the functionality of two-step in that start current, up-slope, down-slope and finish current can all be adjusted.</p>

Saving to Memory

- Press and hold Memory Save Button (E) for 3 seconds to save to memory. The Memory location display indicator (D) will change to a reverse text indicating that the current parameters are the ones in the actively selected memory.

Recalling from Memory

- Press and hold the memory recall button (F) for 3 seconds until the memory location display indicator changes to reversed text indicating the stored parameters are actively recalled.
- When memory parameters are actively selected, the display indicator will remain reversed until a welding parameter is changed with the encoder knob or until the memory location button is pressed to scroll to a different memory location.

Local/Remote Operation

The V320-T AC/DC, when in TIG mode, will automatically sense when the machine has a remote device plugged into the 6 pin MS-type connector-like a remote pedant or a foot amptrol. If a remote device is plugged in, the machine will automatically function in remote mode. If no device is plugged in, the machine will function in local mode.

In remote mode, the operation of the machine is slightly different depending on whether the remote device is a foot amptrol or a remote pendant. To let the machine know what type of device is plugged in, the operator must select the appropriate device from the trigger mode button (See Trigger mode descriptions above for details on the difference). In stick mode the second button on the control panel selects local or remote operation manually. This is required so that the user does not need to detach a foot amptrol to use the machine in STICK mode.

Push button B: Trigger Modes

Stick Trigger Modes

	<p>Local In this mode the machine ignores any remote that is plugged. The machine will weld at the preset value set at the panel of the machine.</p>
	<p>Remote Allows the amperage to be set with a remote potentiometer.</p>

Push button C: TIG Pulse Modes

	<p>Pulse On Turns on pulse welding in TIG mode. Changes the sequence diagram to Pulse TIG and allows the adjustment of the following added parameters:</p> <ul style="list-style-type: none"> • Pulse Frequency • % Peak Time • Background Current
	<p>Pulse Off Turns off pulse welding in TIG.</p>

Welding Parameters

The following parameters are adjustable on the V320-T AC/DC. (See Table B.3)

Parameter Symbol	Parameter Name	Parameter Range		
		Unit	Min	Max
	Pre-Flow	Sec	0	5
	Start Current	A	Min	Peak
	Finish Current	A	Min	Peak
	Min. Current	A	Min	Peak
	Upslope	Sec	0	10
	Downslope	Sec	0	10
	Spot Time	Sec	Off	10
	Max. Current	A	5	320
	Pulse Frequency	Hz	0.20	2500
	Background Current	% A	5%	95%
	% Peak Time	%	5	95
	Postflow	Sec	0	60
	AC Frequency	Hz	20	200
	AC Balance	% EN	35	85
	Hot Start	%	0	500
	Arc Force	%	0	500

Table B.3

Users Menu Setup Parameters

Many additional parameters can be modified via the Set Up Menu. To access the Set Up Menu press and hold the rotary encoder knob for several seconds until the following screen appears (See figure B.7):

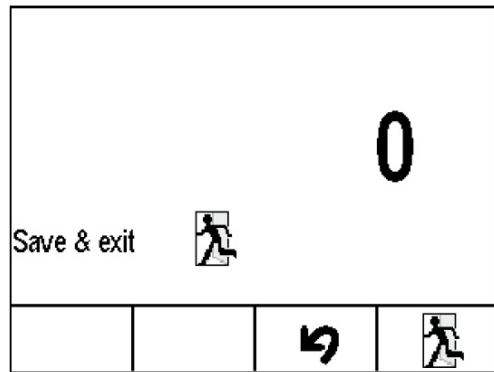

Figure B.7

Rotating the encoder knob will scroll through the setup parameters shown in Table B.4. Selected parameters are changed in one of two ways:

For parameters like background current (shown in Figure B.7a) the change is made by the mode push button. In this example you can toggle between setting background current as either a % or as absolute amperage. Other parameters like selectable wave shape (shown in Figure B.7b) are changed by depressing the encoder knob until the parameter is flashing. Rotating the knob changes the parameter and then the change is saved by pressing the encoder knob again. Once all changes are made you can exit and save by pressing the exit icon button or you can exit the set up menu without saving your changes by depressing the hooked arrow button.

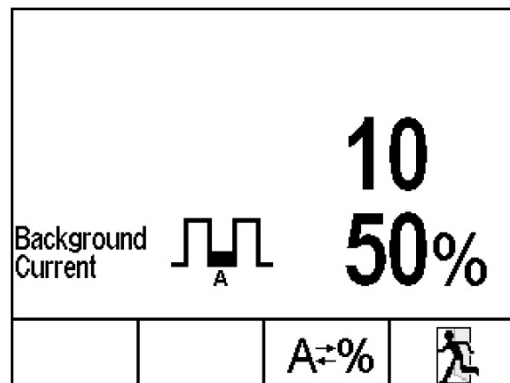

Figure B.7a

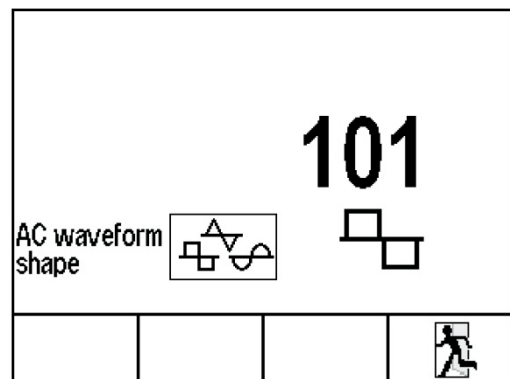

Figure B.7b

Setup Menu Parameters









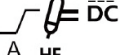
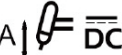
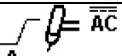
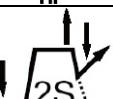

Parameter Symbol	Selection / * Default Value	Parameter Number	Description
See Figure B.7		0	Set Up menu Exit
0	<ul style="list-style-type: none"> N.A. 	1	Reset All Parameters
	<ul style="list-style-type: none"> % * A 	3	Start Current Set Unit
A2	<ul style="list-style-type: none"> % A * 	8	Bi-Level Current 2 Set Unit
	<ul style="list-style-type: none"> % * A 	10	Pulse Background Current Units
	<ul style="list-style-type: none"> % A * 	17	Finish Current Set Unit
	<ul style="list-style-type: none"> 40 A * 	307	DC TIG HF Strike Current
	<ul style="list-style-type: none"> 60 A * 	306	DC LIFT TIG Strike Current
	<ul style="list-style-type: none"> 30 A * 	307	AC TIG HF TIG Strike Current
	<ul style="list-style-type: none"> Enabled * Disabled 	214	2-Step trigger re-start
	<ul style="list-style-type: none"> Enabled Disabled * 	215	4-Step trigger re-start
	<ul style="list-style-type: none"> Square * Sine Triangle 	101	AC Waveform Shape
	<ul style="list-style-type: none"> Enabled Disabled * 	998	Bi-Level Trigger
	<ul style="list-style-type: none"> Enabled Disabled * 	999	Spot Timer Trigger
VRD	<ul style="list-style-type: none"> Off * Enabled to 12 V Enabled to 20 V Enabled to 30 V 	201	VRD Limit
		500	Not Used
	<ul style="list-style-type: none"> 0 ÷ 10 10 * 	552	Speaker Volume
	<ul style="list-style-type: none"> -20 ÷ 20 10 * 	553	Display Contrast
	<ul style="list-style-type: none"> English * French Spanish 	554	Display Language
	<ul style="list-style-type: none"> Display Off Display in 7-segment LED Display * 	751	Output Current Displayed
	<ul style="list-style-type: none"> Display Off * Display in 7-segment LED Display 	752	Output Voltage Displayed
	<ul style="list-style-type: none"> Display Off * Display in 7-segment LED Display 	753	Input Phase Displayed
	<ul style="list-style-type: none"> Display Off * Display in 7-segment LED Display 	754	Input Voltage Displayed
	<p>This function sets the initial start energy limit. Set this number to a higher setting than the factory default if needed to improve starting of large diameter tungsten electrodes.</p> <ul style="list-style-type: none"> 0.5 to 1.0 manual start energy setting. 1.2 to 5.0 = max. Incrementing limit (See Note). <p>Note: The machine will try to start the arc at a start power of 1. If the arc does not establish it will incrementally increase the start power and try to restrike upto the set limit.</p>	104	AC TIG Start Power (for AC TIG only)

Table B.4

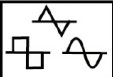
Maintenance

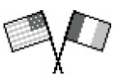
WARNING

For any maintenance or repair operations it is recommended to contact the nearest technical service center or Lincoln Electric. Maintenance or repairs performed by unauthorized service centers or personnel will null and void the manufacturer's warranty.

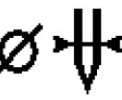
The frequency of the maintenance operations may vary in accordance with the working environment. Any noticeable damage should be reported immediately.

WARNING

Input Filter Capacitor Discharge Procedure

The machine has internal capacitors which are charged to a high voltage during power-on conditions. This voltage is dangerous and must be discharged before the machine can be serviced. Discharging is done automatically by the machine each time the power is switched off. However, you must allow the machine to sit for at least 5 minutes to allow time for the process to take place.

- Check cables and connections integrity. Replace, if necessary.
- Keep clean the machine. Use a soft dry cloth to clean the external case, especially the airflow inlet / outlet louvers.
- Always use gloves in compliance with the safety standards.

WARNING

Do not open this machine and do not introduce anything into its openings. Power supply must be disconnected from the machine before each maintenance and service. After each repair, perform proper tests to ensure safety.

Electromagnetic Compatibility (EMC)

11/04

This machine has been designed in accordance with all relevant directives and standards. However, it may still generate electromagnetic disturbances that can affect other systems like telecommunications (telephone, radio, and television) or other safety systems. These disturbances can cause safety problems in the affected systems. Read and understand this section to eliminate or reduce the amount of electromagnetic disturbance generated by this machine.



This machine has been designed to operate in an industrial area. To operate in a domestic area it is necessary to observe particular precautions to eliminate possible electromagnetic disturbances. The operator must install and operate this equipment as described in this manual. If any electromagnetic disturbances are detected the operator must put in place corrective actions to eliminate these disturbances with, if necessary, assistance from Lincoln Electric.

Before installing the machine, the operator must check the work area for any devices that may malfunction because of electromagnetic disturbances. Consider the following.

- Input and output cables, control cables, and telephone cables that are in or adjacent to the work area and the machine.
- Radio and/or television transmitters and receivers. Computers or computer controlled equipment.
- Safety and control equipment for industrial processes. Equipment for calibration and measurement.
- Personal medical devices like pacemakers and hearing aids.
- Check the electromagnetic immunity for equipment operating in or near the work area. The operator must be sure that all equipment in the area is compatible. This may require additional protection measures.
- The dimensions of the work area to consider will depend on the construction of the area and other activities that are taking place.

Consider the following guidelines to reduce electromagnetic emissions from the machine.

- Connect the machine to the input supply according to this manual. If disturbances occur it may be necessary to take additional precautions such as filtering the input supply.
- The output cables should be kept as short as possible and should be positioned together. If possible connect the work piece to ground in order to reduce the electromagnetic emissions. The operator must check that connecting the work piece to ground does not cause problems or unsafe operating conditions for personnel and equipment.
- Shielding of cables in the work area can reduce electromagnetic emissions. This may be necessary for special applications.

Technical Specifications

V320-T AC/DC:

INPUT				
Voltage 230/400 Vac		Phase 3 ph		Frequency 50-60 Hz
RATED INPUT and OUTPUT @ 40°C				
Phase	Input Voltage	Rated Output Current / Voltage / Duty Cycle (Duty Cycle: Based on a 10 min. period)		Input Current @ Rated Output
3	400 Vac	TIG	250 A / 20 V / 100%	10.0 A
			280 A / 21.2 V / 60%	11.8 A
			320 A / 22.8 V / 35%	14.5 A
	230 Vac	Stick	230A / 29.2 V / 100%	12.5 A
			250A / 30 V / 60%	14.0 A
			300A / 32 V / 30%	17.8 A
230 Vac	TIG	220 A / 18.8 V / 100%	14.7 A	
		260 A / 20.4 V / 60%	18.7 A	
		320 A / 22.8 V / 30%	26.4 A	
230 Vac	Stick	200 A / 28.0 V / 100%	18.6 A	
		230 A / 29.2 V / 60%	22.3 A	
		300 A / 32 V / 20%	32.3 A	
OUTPUT RANGE				
Welding Current Range 5-320 A		Maximum Open Circuit Voltage 80 V		Type of Output AC / DC
RECOMMENDED INPUT CABLE AND FUSE SIZES for MAXIMUM OUTPUT				
Maximum Time-Delay Circuit Breaker or Super Lag Fuse Size 32 A				Input Power Cable 4 x 4 mm ²
PHYSICAL DIMENSIONS				
Height 432 mm	Width 280 mm	Length 622 mm	Weight 27.5 Kg	
Operating Temperature -20°C to +40°C			Storage Temperature -25°C to +55°C	