

Operator's Manual

ALUMAFAB™

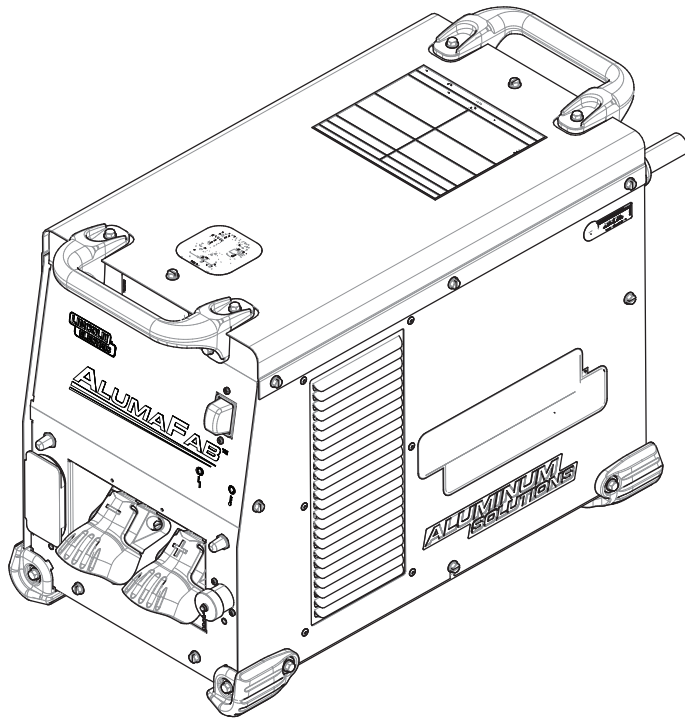

For use with machines having Code Numbers:
12374, 12566, 12608



Register your machine:

www.lincolnelectric.com/register

Authorized Service and Distributor Locator:

www.lincolnelectric.com/locator

Save for future reference

Date Purchased

Code: (ex: 10859)

Serial: (ex: U1060512345)

THANK YOU FOR SELECTING A QUALITY PRODUCT BY LINCOLN ELECTRIC.

PLEASE EXAMINE CARTON AND EQUIPMENT FOR DAMAGE IMMEDIATELY

When this equipment is shipped, title passes to the purchaser upon receipt by the carrier. Consequently, claims for material damaged in shipment must be made by the purchaser against the transportation company at the time the shipment is received.

SAFETY DEPENDS ON YOU

Lincoln arc welding and cutting equipment is designed and built with safety in mind. However, your overall safety can be increased by proper installation ... and thoughtful operation on your part. **DO NOT INSTALL, OPERATE OR REPAIR THIS EQUIPMENT WITHOUT READING THIS MANUAL AND THE SAFETY PRECAUTIONS CONTAINED THROUGHOUT.** And, most importantly, think before you act and be careful.

WARNING

This statement appears where the information must be followed exactly to avoid serious personal injury or loss of life.

CAUTION

This statement appears where the information must be followed to avoid minor personal injury or damage to this equipment.



KEEP YOUR HEAD OUT OF THE FUMES.

DON'T get too close to the arc. Use corrective lenses if necessary to stay a reasonable distance away from the arc.

READ and obey the Safety Data Sheet (SDS) and the warning label that appears on all containers of welding materials.

USE ENOUGH VENTILATION or exhaust at the arc, or both, to keep the fumes and gases from your breathing zone and the general area.

IN A LARGE ROOM OR OUTDOORS, natural ventilation may be adequate if you keep your head out of the fumes (See below).

USE NATURAL DRAFTS or fans to keep the fumes away from your face.

If you develop unusual symptoms, see your supervisor. Perhaps the welding atmosphere and ventilation system should be checked.

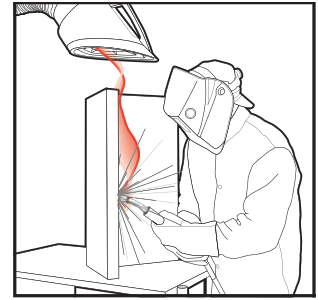

WEAR CORRECT EYE, EAR & BODY PROTECTION

PROTECT your eyes and face with welding helmet properly fitted and with proper grade of filter plate (See ANSI Z49.1).

PROTECT your body from welding spatter and arc flash with protective clothing including woolen clothing, flame-proof apron and gloves, leather leggings, and high boots.

PROTECT others from splatter, flash, and glare with protective screens or barriers.

IN SOME AREAS, protection from noise may be appropriate.

BE SURE protective equipment is in good condition.

Also, wear safety glasses in work area **AT ALL TIMES.**



SPECIAL SITUATIONS

DO NOT WELD OR CUT containers or materials which previously had been in contact with hazardous substances unless they are properly cleaned. This is extremely dangerous.

DO NOT WELD OR CUT painted or plated parts unless special precautions with ventilation have been taken. They can release highly toxic fumes or gases.

Additional precautionary measures

PROTECT compressed gas cylinders from excessive heat, mechanical shocks, and arcs; fasten cylinders so they cannot fall.

BE SURE cylinders are never grounded or part of an electrical circuit.

REMOVE all potential fire hazards from welding area.

ALWAYS HAVE FIRE FIGHTING EQUIPMENT READY FOR IMMEDIATE USE AND KNOW HOW TO USE IT.



SECTION A: WARNINGS



CALIFORNIA PROPOSITION 65 WARNINGS



WARNING: Breathing diesel engine exhaust exposes you to chemicals known to the State of California to cause cancer and birth defects, or other reproductive harm.

- Always start and operate the engine in a well-ventilated area.
- If in an exposed area, vent the exhaust to the outside.
- Do not modify or tamper with the exhaust system.
- Do not idle the engine except as necessary.

For more information go to www.P65warnings.ca.gov/diesel

WARNING: This product, when used for welding or cutting, produces fumes or gases which contain chemicals known to the State of California to cause birth defects and, in some cases, cancer. (California Health & Safety Code § 25249.5 *et seq.*)



WARNING: Cancer and Reproductive Harm
www.P65warnings.ca.gov

ARC WELDING CAN BE HAZARDOUS. PROTECT YOURSELF AND OTHERS FROM POSSIBLE SERIOUS INJURY OR DEATH. KEEP CHILDREN AWAY. PACEMAKER WEARERS SHOULD CONSULT WITH THEIR DOCTOR BEFORE OPERATING.

Read and understand the following safety highlights. For additional safety information, it is strongly recommended that you purchase a copy of "Safety in Welding & Cutting - ANSI Standard Z49.1" from the American Welding Society, P.O. Box 351040, Miami, Florida 33135 or CSA Standard W117.2-1974. A Free copy of "Arc Welding Safety" booklet E205 is available from the Lincoln Electric Company, 22801 St. Clair Avenue, Cleveland, Ohio 44117-1199.

BE SURE THAT ALL INSTALLATION, OPERATION, MAINTENANCE AND REPAIR PROCEDURES ARE PERFORMED ONLY BY QUALIFIED INDIVIDUALS.



FOR ENGINE POWERED EQUIPMENT.

- 1.a. Turn the engine off before troubleshooting and maintenance work unless the maintenance work requires it to be running.
- 1.b. Operate engines in open, well-ventilated areas or vent the engine exhaust fumes outdoors.
- 1.c. Do not add the fuel near an open flame welding arc or when the engine is running. Stop the engine and allow it to cool before refueling to prevent spilled fuel from vaporizing on contact



with hot engine parts and igniting. Do not spill fuel when filling tank. If fuel is spilled, wipe it up and do not start engine until fumes have been eliminated.

- 1.d. Keep all equipment safety guards, covers and devices in position and in good repair. Keep hands, hair, clothing and tools away from V-belts, gears, fans and all other moving parts when starting, operating or repairing equipment.
- 1.e. In some cases it may be necessary to remove safety guards to perform required maintenance. Remove guards only when necessary and replace them when the maintenance requiring their removal is complete. Always use the greatest care when working near moving parts.
- 1.f. Do not put your hands near the engine fan. Do not attempt to override the governor or idler by pushing on the throttle control rods while the engine is running.
- 1.g. To prevent accidentally starting gasoline engines while turning the engine or welding generator during maintenance work, disconnect the spark plug wires, distributor cap or magneto wire as appropriate.
- 1.h. To avoid scalding, do not remove the radiator pressure cap when the engine is hot.



ELECTRIC AND MAGNETIC FIELDS MAY BE DANGEROUS



- 2.a. Electric current flowing through any conductor causes localized Electric and Magnetic Fields (EMF). Welding current creates EMF fields around welding cables and welding machines
- 2.b. EMF fields may interfere with some pacemakers, and welders having a pacemaker should consult their physician before welding.
- 2.c. Exposure to EMF fields in welding may have other health effects which are now not known.
- 2.d. All welders should use the following procedures in order to minimize exposure to EMF fields from the welding circuit:
 - 2.d.1. Route the electrode and work cables together - Secure them with tape when possible.
 - 2.d.2. Never coil the electrode lead around your body.
 - 2.d.3. Do not place your body between the electrode and work cables. If the electrode cable is on your right side, the work cable should also be on your right side.
 - 2.d.4. Connect the work cable to the workpiece as close as possible to the area being welded.
 - 2.d.5. Do not work next to welding power source.



ELECTRIC SHOCK CAN KILL.



- 3.a. The electrode and work (or ground) circuits are electrically “hot” when the welder is on. Do not touch these “hot” parts with your bare skin or wet clothing. Wear dry, hole-free gloves to insulate hands.
- 3.b. Insulate yourself from work and ground using dry insulation. Make certain the insulation is large enough to cover your full area of physical contact with work and ground.

In addition to the normal safety precautions, if welding must be performed under electrically hazardous conditions (in damp locations or while wearing wet clothing; on metal structures such as floors, gratings or scaffolds; when in cramped positions such as sitting, kneeling or lying, if there is a high risk of unavoidable or accidental contact with the workpiece or ground) use the following equipment:

- Semiautomatic DC Constant Voltage (Wire) Welder.
 - DC Manual (Stick) Welder.
 - AC Welder with Reduced Voltage Control.
- 3.c. In semiautomatic or automatic wire welding, the electrode, electrode reel, welding head, nozzle or semiautomatic welding gun are also electrically “hot”.
 - 3.d. Always be sure the work cable makes a good electrical connection with the metal being welded. The connection should be as close as possible to the area being welded.
 - 3.e. Ground the work or metal to be welded to a good electrical (earth) ground.
 - 3.f. Maintain the electrode holder, work clamp, welding cable and welding machine in good, safe operating condition. Replace damaged insulation.
 - 3.g. Never dip the electrode in water for cooling.
 - 3.h. Never simultaneously touch electrically “hot” parts of electrode holders connected to two welders because voltage between the two can be the total of the open circuit voltage of both welders.
 - 3.i. When working above floor level, use a safety belt to protect yourself from a fall should you get a shock.
 - 3.j. Also see Items 6.c. and 8.



ARC RAYS CAN BURN.



- 4.a. Use a shield with the proper filter and cover plates to protect your eyes from sparks and the rays of the arc when welding or observing open arc welding. Headshield and filter lens should conform to ANSI Z87.1 standards.
- 4.b. Use suitable clothing made from durable flame-resistant material to protect your skin and that of your helpers from the arc rays.
- 4.c. Protect other nearby personnel with suitable, non-flammable screening and/or warn them not to watch the arc nor expose themselves to the arc rays or to hot spatter or metal.



FUMES AND GASES CAN BE DANGEROUS.



- 5.a. Welding may produce fumes and gases hazardous to health. Avoid breathing these fumes and gases. When welding, keep your head out of the fume. Use enough ventilation and/or exhaust at the arc to keep fumes and gases away from the breathing zone. **When welding hardfacing (see instructions on container or SDS) or on lead or cadmium plated steel and other metals or coatings which produce highly toxic fumes, keep exposure as low as possible and within applicable OSHA PEL and ACGIH TLV limits using local exhaust or mechanical ventilation unless exposure assessments indicate otherwise. In confined spaces or in some circumstances, outdoors, a respirator may also be required. Additional precautions are also required when welding on galvanized steel.**
- 5.b. The operation of welding fume control equipment is affected by various factors including proper use and positioning of the equipment, maintenance of the equipment and the specific welding procedure and application involved. Worker exposure level should be checked upon installation and periodically thereafter to be certain it is within applicable OSHA PEL and ACGIH TLV limits.
- 5.c. Do not weld in locations near chlorinated hydrocarbon vapors coming from degreasing, cleaning or spraying operations. The heat and rays of the arc can react with solvent vapors to form phosgene, a highly toxic gas, and other irritating products.
- 5.d. Shielding gases used for arc welding can displace air and cause injury or death. Always use enough ventilation, especially in confined areas, to insure breathing air is safe.
- 5.e. Read and understand the manufacturer’s instructions for this equipment and the consumables to be used, including the Safety Data Sheet (SDS) and follow your employer’s safety practices. SDS forms are available from your welding distributor or from the manufacturer.
- 5.f. Also see item 1.b.



WELDING AND CUTTING SPARKS CAN CAUSE FIRE OR EXPLOSION.

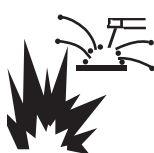

- 6.a. Remove fire hazards from the welding area. If this is not possible, cover them to prevent the welding sparks from starting a fire. Remember that welding sparks and hot materials from welding can easily go through small cracks and openings to adjacent areas. Avoid welding near hydraulic lines. Have a fire extinguisher readily available.
- 6.b. Where compressed gases are to be used at the job site, special precautions should be used to prevent hazardous situations. Refer to "Safety in Welding and Cutting" (ANSI Standard Z49.1) and the operating information for the equipment being used.
- 6.c. When not welding, make certain no part of the electrode circuit is touching the work or ground. Accidental contact can cause overheating and create a fire hazard.
- 6.d. Do not heat, cut or weld tanks, drums or containers until the proper steps have been taken to insure that such procedures will not cause flammable or toxic vapors from substances inside. They can cause an explosion even though they have been "cleaned". For information, purchase "Recommended Safe Practices for the Preparation for Welding and Cutting of Containers and Piping That Have Held Hazardous Substances", AWS F4.1 from the American Welding Society (see address above).
- 6.e. Vent hollow castings or containers before heating, cutting or welding. They may explode.
- 6.f. Sparks and spatter are thrown from the welding arc. Wear oil free protective garments such as leather gloves, heavy shirt, cuffless trousers, high shoes and a cap over your hair. Wear ear plugs when welding out of position or in confined places. Always wear safety glasses with side shields when in a welding area.
- 6.g. Connect the work cable to the work as close to the welding area as practical. Work cables connected to the building framework or other locations away from the welding area increase the possibility of the welding current passing through lifting chains, crane cables or other alternate circuits. This can create fire hazards or overheat lifting chains or cables until they fail.
- 6.h. Also see item 1.c.
- 6.i. Read and follow NFPA 51B "Standard for Fire Prevention During Welding, Cutting and Other Hot Work", available from NFPA, 1 Batterymarch Park, PO box 9101, Quincy, MA 022690-9101.
- 6.j. Do not use a welding power source for pipe thawing.



CYLINDER MAY EXPLODE IF DAMAGED.

- 7.a. Use only compressed gas cylinders containing the correct shielding gas for the process used and properly operating regulators designed for the gas and pressure used. All hoses, fittings, etc. should be suitable for the application and maintained in good condition. 
- 7.b. Always keep cylinders in an upright position securely chained to an undercarriage or fixed support.
- 7.c. Cylinders should be located:
 - Away from areas where they may be struck or subjected to physical damage.
 - A safe distance from arc welding or cutting operations and any other source of heat, sparks, or flame.
- 7.d. Never allow the electrode, electrode holder or any other electrically "hot" parts to touch a cylinder.
- 7.e. Keep your head and face away from the cylinder valve outlet when opening the cylinder valve.
- 7.f. Valve protection caps should always be in place and hand tight except when the cylinder is in use or connected for use.
- 7.g. Read and follow the instructions on compressed gas cylinders, associated equipment, and CGA publication P-1, "Precautions for Safe Handling of Compressed Gases in Cylinders," available from the Compressed Gas Association, 14501 George Carter Way Chantilly, VA 20151.



FOR ELECTRICALLY POWERED EQUIPMENT.



- 8.a. Turn off input power using the disconnect switch at the fuse box before working on the equipment.
- 8.b. Install equipment in accordance with the U.S. National Electrical Code, all local codes and the manufacturer's recommendations.
- 8.c. Ground the equipment in accordance with the U.S. National Electrical Code and the manufacturer's recommendations.

Refer to
<http://www.lincolnelectric.com/safety>
for additional safety information.

	Page
Changes After Initial Release	8
Product Description	9
Recommended Processes and Equipment	10
Recommended Processes	10
Process Limitations	10
Equipment Limitations.....	10
Common Equipment Packages.....	10
Common Optional Kits & Accessories	11
Compatible Wire Feeders	11
Design	Section A
Specifications	A-1
Agency Approvals	A-2
Design Features.....	A-2
Case Front Controls.....	A-3
Case Back Controls.....	A-4
Installation	Section B
Input and Ground Connections	B-1
Input Fuse and Wire Supply Considerations.....	B-2
Input Voltage Selection.....	B-3
Location.....	B-3
Location and Ventilation for Cooling	B-3
Lifting.....	B-3
Stacking	B-3
Tilting.....	B-3
Environmental Limitations	B-3
High Frequency Protection	B-3
Connection Diagrams, Control Cables.....	B-4, B-5
ArcLink Wire Feeder & Digital Accessory Connectivity.....	B-4
Recommended Electrode and Work Cable Sizes for Arc Welding	B-5
Output Cable Guidelines	B-5
Control Cable and Voltage Sensing Connections	B-6
PF84 Setup with AlumaFab™.....	B-7
PF25 Setup with AlumaFab™.....	B-7
Operation	Section C
Graphic Symbols Appearing in this Machine or in this Manual	C-1
Power Up Sequence.....	C-2
Safety Warnings.....	C-2
Duty Cycle	C-3
Definition of Welding Modes.....	C-3
Synergic Welding Modes	C-3
Weld Controls and Displays.....	C-3
Weld Processor Selector Switch.....	C-3
Output Control Dial on the Feeder.....	C-4
Volt Display Meter on the Feeder	C-4
Amperage Display Meter on the Feeder	C-4
Thermal Light.....	C-4
ArcLink.....	C-5
Pulse Welding in ArcLink Mode	C-5

Accessories	Section D
General Options / Accessories.....	D-1
Fume Extracting Systems	D-1
Stick Options	D-1
TIG Welding Options / Accessories	D-1
Maintenance	Section E
Safety Precautions	E-1
Visual Inspection	E-1
Routine Maintenance	E-1
Periodic Maintenance.....	E-1
Troubleshooting	Section F
Safety Precautions	F-1
How to Use Troubleshooting Guide	F-1
Troubleshooting Guide	F-2
Wiring Diagrams	Section G
Parts List	parts.lincolnelectric.com

Content/details may be changed or updated without notice. For most current Operator's Manual, go to parts.lincolnelectric.com.

CHANGES AFTER INITIAL RELEASE

PRODUCT DESCRIPTION

Product Summary

The Alumafab™ is a multi-process CV/Pulse DC inverter power source rated for 450 Amps, 36.5 Volts at 100% duty cycle. The Alumafab™ comes in a rugged case and is intended for either indoor or outdoor operation and comes with an IP23 environmental rating. Transporting the Alumafab™ is made simple through lifting handles. Weld modes are selected via the user interface on an ArcLink Feeder (PF25M AL). Volts and Amps are displayed and are set via control knobs on the feeder. The Alumafab™ is designed for the North America markets and operates on 460V, or 575V 60hz three phase power. Switching between voltages is made simple via a reconnect panel located on the case back. The Alumafab™ also comes with a 115V receptacle, capable of handling up to 5A, for either a water cooler or other external device(s).

The Alumafab™ is designed to be compatible with the current range of semi-automatic ArcLink wire feeders. The Alumafab™ comes with a 5-pin amphenol standard. Voltage sensing is either done at the studs or via a 67 lead when operating with an ArcLink wire feeder.

The Alumafab™ machine is factory pre-programmed with multiple welding procedures including GMAW, GMAW-P aluminum.

RECOMMENDED PROCESSES AND EQUIPMENT

RECOMMENDED PROCESSES

The Alumafab™ is designed for CV-GMAW & CV-GMAW-P welding processes.

WELD MODE	PROCESS	COMMON MATERIALS	COMMON ELECTRODES
CV	MIG (GMAW)	ALUMINUM	ALL 4XXX & 5XXX

PROCESS LIMITATIONS

The Alumafab is suitable only for the processes listed.

EQUIPMENT LIMITATIONS

Operating Temperature Range is -10° C to + 55° C.

Output is de-rated for temperatures in excess of 40° C.

OUTPUT RATINGS AT 40° C			
AMPS	DUTY CYCLE	VOLTS	TEMPERATURE
450	100%	36.5V	40° C
500	60%	40V	
OUTPUT RATINGS AT 55° C ELEVATED TEMPERATURES			
AMPS	DUTY CYCLE	VOLTS	TEMPERATURE
375	100%	35V	55° C
400	60%	36V	

COMMON EQUIPMENT PACKAGES

BASIC PACKAGE (K4186-2 AIR COOLED READY PAK)	
K4189-1	ALUMAFAB™ POWER SOURCE
K4191-1	POWER FEED 25M ALUMINUM
K3355-2	25' MAGNUM PRO AL G225A
K3059-2	INVERTER CART
K2149-1	WORK LEAD PACKAGE
K3056-2	BASE MOUNTING ASSEMBLY
K1543-8	ARC LINK CABLE 8'
3100211	HARRIS REGULATOR AND GAS HOSES

BASIC PACKAGE (K4187-2 WATER COOLED READY PAK)	
K4189-1	ALUMAFAB™ POWER SOURCE
K4191-1	POWER FEED 25M ALUMINUM
K3357-2	25' MAGNUM PRO AL G225A
K3059-2	INVERTER CART
K2149-1	WORK LEAD PACKAGE
K3056-2	BASE MOUNTING ASSEMBLY
K1543-8	ARC LINK CABLE 8'
3100211	HARRIS REGULATOR AND GAS HOSES
KP3379-4	MAGNUM PRO COOLANT

* View details at www.lincolnelectric.com

COMMON OPTIONAL KITS & ACCESSORIES

K3059-2	INVERTER CART
K3056-2	BASE MOUNTING KIT

COMPATIBLE WIRE FEEDERS – ANALOG & ARCLINK FEEDERS**NORTH AMERICAN SEMI-AUTOMATIC WIRE FEEDERS**

PF25M, PF84	POWER FEED SERIES (40VDC INPUT)
-------------	---------------------------------

DESIGN

TECHNICAL SPECIFICATIONS

POWER SOURCES - INPUT VOLTAGE AND CURRENT

MODEL	DUTY CYCLE	INPUT VOLTAGE \pm 10%	INPUT AMPERES	IDLE POWER (W)	POWER FACTOR
K4189-1	60% RATING	460 / 575 / 3 / 60	33 / 30	150W FAN ON	85%
	100% RATING		26 / 26	70W FAN OFF	

POWER SOURCES - RECOMMENDED INPUT WIRE AND FUSE SIZES¹

VOLTAGE	INPUT AMPERES (100% RATING)	TIME DELAY FUSE OR BREAKER SIZE	TYPE 75C COPPER WIRE IN CONDUIT AWG (IEC) SIZES 40C (104°F) AMBIENT	TYPE 75C COPPER GROUND WIRE IN CONDUIT AWG (IEC) SIZES	CORD SIZE AWG SIZES
460/3/60	26 A	50	10 (6)	10 (6)	8
575/3/60	26 A	50	10 (6)	10 (6)	8

RATED OUTPUT

PROCESS	DUTY CYCLE	VOLTS AT RATED AMPERES	AMPERES	EFFICIENCY (AT RATED OUTPUT)
GMAW (CV)	60%	39 V	500A	89%
	100%	36.5 V	450A	
GMAW-P (CV)	60%	39 V	500A	
	100%	36.5 V	450A	

PHYSICAL DIMENSIONS

MODEL	HEIGHT	WIDTH	DEPTH	WEIGHT
K4189-1	18.8 IN (477 MM)	14 IN (356 MM)	26.5 IN (673 MM)	145 LBS. (65.77 KG)

TEMPERATURE RANGES

OPERATING TEMPERATURE	14° F TO 131° F (-10° C TO 55° C)*
STORAGE TEMPERATURE	-40° F TO 185° F (-40° C TO 85° C)
INSULATION CLASS	CLASS H (180° C)

*Output is derated for temperatures in excess of 40° C (104° F).

AGENCY APPROVALS

MODEL	MARKET	CONFORMITY MARK
K189-1	US AND CANADA	CSA _{CUS}

DESIGN FEATURES

- **The Future is Now** – You no longer have to pay a price premium to gain the advantages of inverter technology over conventional welders.
 - Faster arc response means smoother arc action and more consistent bead appearance.
 - Low power consumption results in daily operational cost savings.
 - Enhanced portability – typically 50% less weight, size and footprint.
- **Simple and Easy to Use**
- **Aluminum Dedicated** – Optimized modes specifically tailored for aluminum.
- **Compact, Durable Case** – Tough IP23 enclosure rating ensures the ability to withstand extreme field environments.
- **Procedure Control** – Utilize ArcLink Feeder capabilities such as user memories, preference options, and procedure lockouts
- **Full-Featured Remote Control Capability** – Use a foot pedal or hand control to remotely vary output up to 100 ft. (30.5 mm) away. Master / Slave functionality for precise arc control.
- **460 – 575 VAC, 60Hz Voltage Input** – Offers the ability to be connected anywhere in North America.
- **Voltage Compensation and Reliable Input Voltage Connection** – Provides consistent operation over $\pm 10\%$ input voltage variation.
- **Severe Duty** – Can be stored outdoors. IP23 Rated.
- **Desert Duty Rated** – Welding outputs are rated for extreme temperature operation up to 55° C
- **ArcLink® Wire Feeder Compatible** – unlock synergic and pulse modes to increase productivity and control
- **Synergic Modes** – for easy, repeatable welds
- **Pulse Modes** – for demanding applications that require low heat input and reduced spatter
- **Low Operating Cost** – Operates at a high efficiency
- **Transport** - Reversible handles for ease of lifting.

CASE FRONT CONTROLS

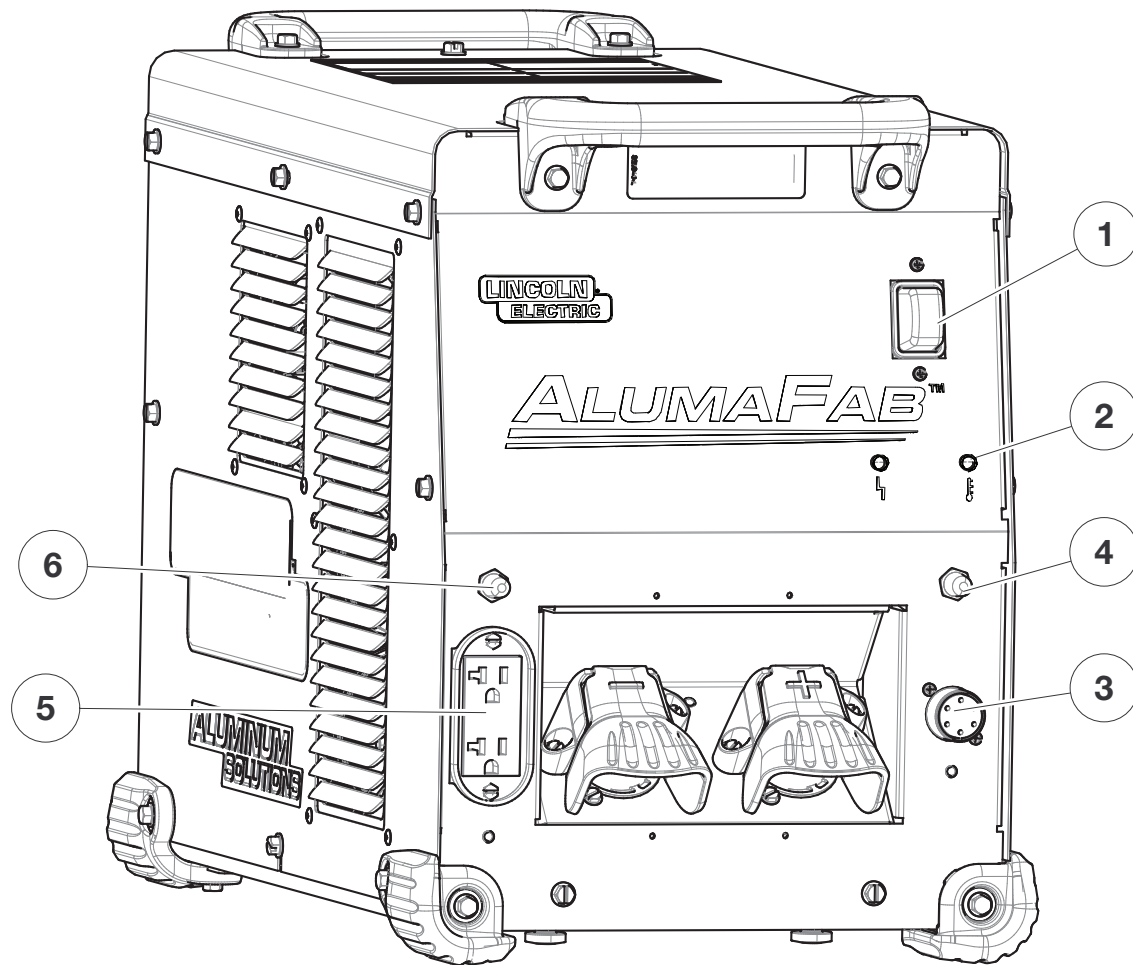

CASE FRONT CONTROLS DESCRIPTIONS.

1. **Power Switch:**
Controls input power to the AlumaFab™.
2. **Thermal LED:**
A yellow light that comes on when an over temperature situation occurs.
Output is disabled until the machine cools down.
When cool, the light goes out and output is enabled.
3. **5-pin ArcLink Connector.**
4. **Circuit breaker reset button for the 5-pin wire feeder connector.**
5. **115V Receptacle.**
6. **Circuit breaker reset button for the 115V Receptacle.**

CASE BACK CONTROLS

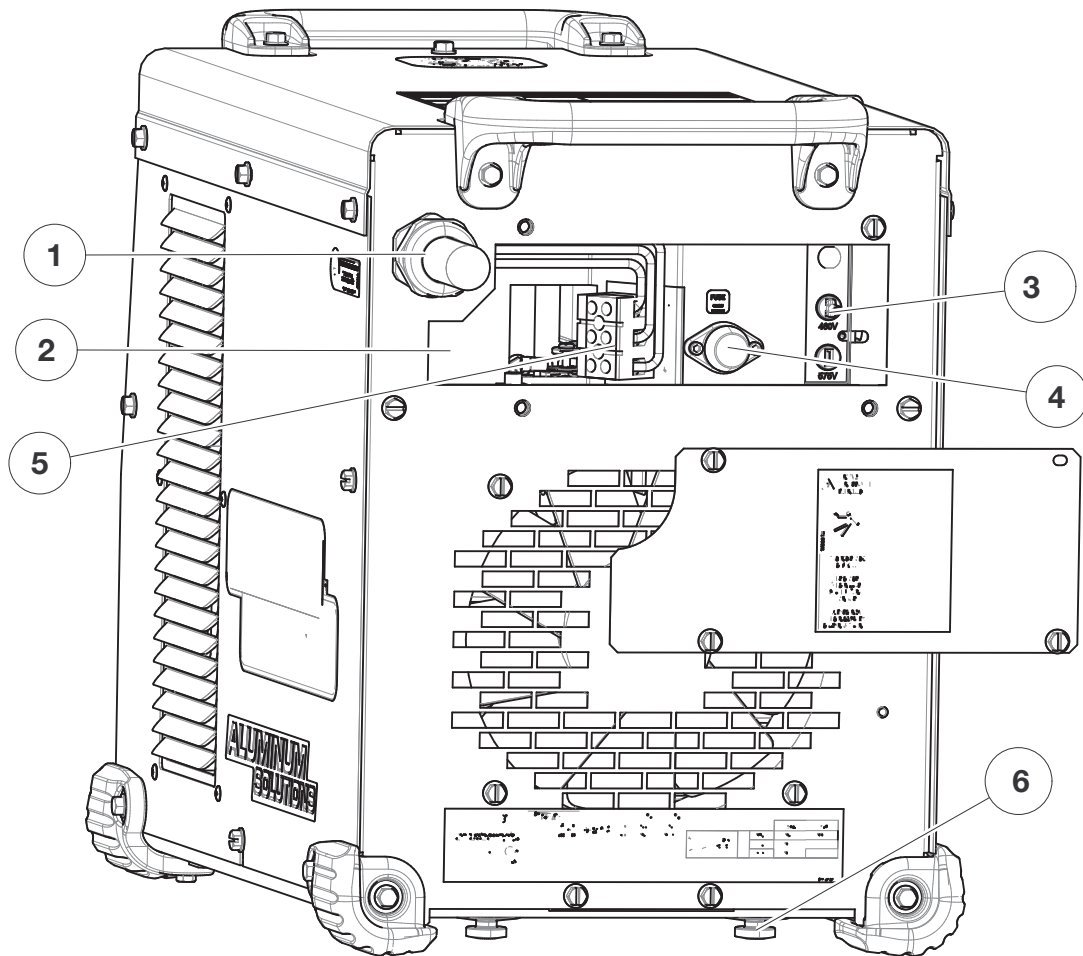

CASE BACK CONTROLS DESCRIPTIONS.

1. **Input Power Cord Access Hole**
2. **Access Panel** – Allows access for connecting input power and configuring the machine
3. **Input Power Reconnect** – Configures the machine for the input supply voltage
4. **Input Power Fuse Protection**
5. **Input Power Connection Terminal Block**
6. **OPTION** – Base Mounting Kit

INSTALLATION



WARNING



ELECTRIC SHOCK CAN KILL.

ONLY QUALIFIED PERSONNEL SHOULD PERFORM THIS INSTALLATION.

- **TURN OFF INPUT POWER TO THE POWER SOURCE AT THE DISCONNECT SWITCH OR FUSE BOX BEFORE WORKING ON THIS EQUIPMENT. TURN OFF THE INPUT POWER TO ANY OTHER EQUIPMENT CONNECTED TO THE WELDING SYSTEM AT THE DISCONNECT SWITCH OR FUSE BOX BEFORE WORKING ON THE EQUIPMENT.**
- **DO NOT TOUCH ELECTRICALLY HOT PARTS.**
- **ALWAYS CONNECT THE GROUNDING LUG (LOCATED INSIDE THE RECONNECT INPUT ACCESS DOOR) TO A PROPER SAFETY (EARTH) GROUND.**
- **ONLY A QUALIFIED ELECTRICIAN SHOULD CONNECT THE INPUT LEADS TO THE MACHINE. CONNECTIONS SHOULD BE MADE IN ACCORDANCE WITH ALL LOCAL AND NATIONAL ELECTRICAL CODES AND THE CONNECTION DIAGRAM LOCATED UNDERNEATH THE CASE TOP OF THE MACHINE. FAILURE TO DO SO MAY RESULT IN BODILY INJURY OR DEATH.**

INPUT AND GROUND CONNECTIONS

MACHINE GROUNDING

The frame of the welder must be grounded. A ground terminal marked with the symbol shown is located inside the reconnect/input connection area for this purpose. See your local and national electrical codes for proper grounding methods.



Use a three-phase supply line. A 1.75 inch (45 mm) diameter access hole for the input supply is located on the case back. Remove the reconnect access panel located on the case back and connect L1, L2, L3 and ground according to the Input Supply Connection Diagram decal. (See Figure B.1)

Figure B.1

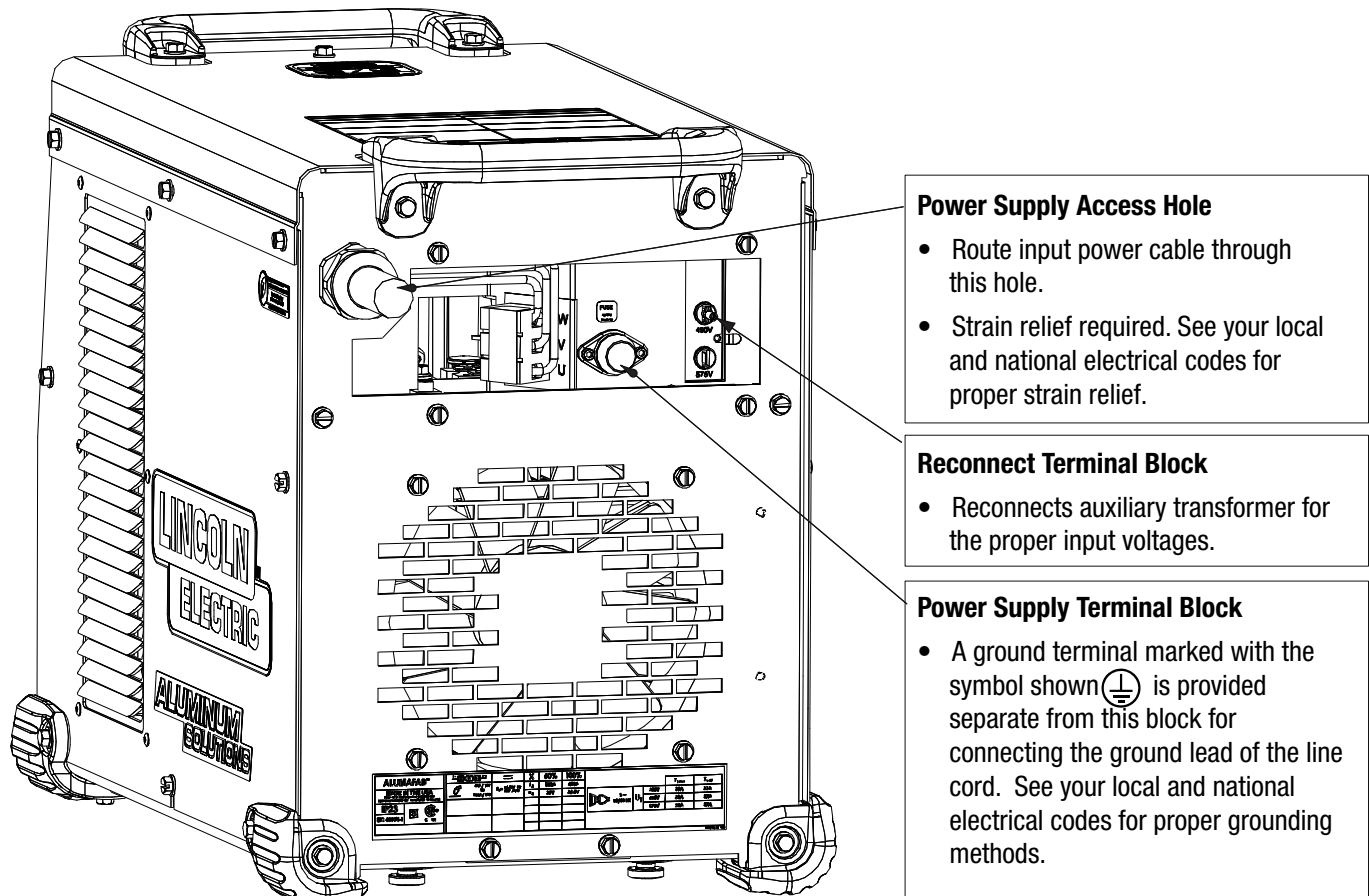

Input Fuse and Supply Wire Considerations

Refer to **Page A-1** for recommended fuse, wire sizes and type of the copper wires. Fuse the input circuit with the recommended super lag fuse or delay type breakers (also called "inverse time" or "thermal/magnetic" circuit breakers). Choose input and grounding wire size according to local or national electrical codes. Using input wire sizes, fuses or circuit breakers smaller than recommended may result in "nuisance" shut-offs from welder inrush currents, even if the machine is not being used at high currents.

INPUT VOLTAGE SELECTION

Welders are shipped connected for 460V input voltage. If the Auxiliary lead (indicated as 'A') is placed in the wrong position and power is applied to the machine, the machine will protect itself:

- The User Interface board and Switch Boards will blink out error 713 or 714 on their status LEDs.
- The weld output will be turned off and the control board will force itself into an idle state. The FAN will run continuously.
- The machine will need to have the misconnect condition removed before it will recover.

LOCATION

Location and ventilation for cooling

Place the welder where clean cooling air can freely circulate in through the rear louvers and out through the case sides and front. Dirt, dust, or any foreign material that can be drawn into the welder should be kept at a minimum. Failure to observe these precautions can result in excessive operating temperatures and nuisance shutdowns.

Lifting

The Alumafab™ has two handles that can be used to lift the machine.

Both handles should be used when lifting the machine. When using a crane or overhead device to lift using the handles, a lifting strap should be connected to both handles. Do not attempt to lift the Alumafab™ with accessories attached to it.

Stacking

The Alumafab™ can only be stacked on top of appropriate accessories. Nothing can be stacked on top of the machine.

Tilting

Place the machine directly on a secure, level surface or on a recommended undercarriage. The machine may topple over if this procedure is not followed.

Environmental limitations

The Alumafab™ is IP23 rated for use in an outdoor environment. The machine should not be subjected to falling water during use nor should any parts of it be submerged in water. Doing so may cause improper operation as well as pose a safety hazard. The best practice is to keep the machine in a dry, sheltered area.

Do not mount the Alumafab™ over combustible surfaces. Where there is a combustible surface directly under stationary or fixed electrical equipment, that surface shall be covered with a steel plate at least .060" (1.6mm) thick, which shall extend not less than 5.90" (150mm) beyond the equipment on all sides.

HIGH FREQUENCY PROTECTION

Locate the Alumafab™ away from radio controlled machinery. The normal operation of the machine may adversely affect the operation of RF controlled equipment, which may result in bodily injury or damage to the equipment.

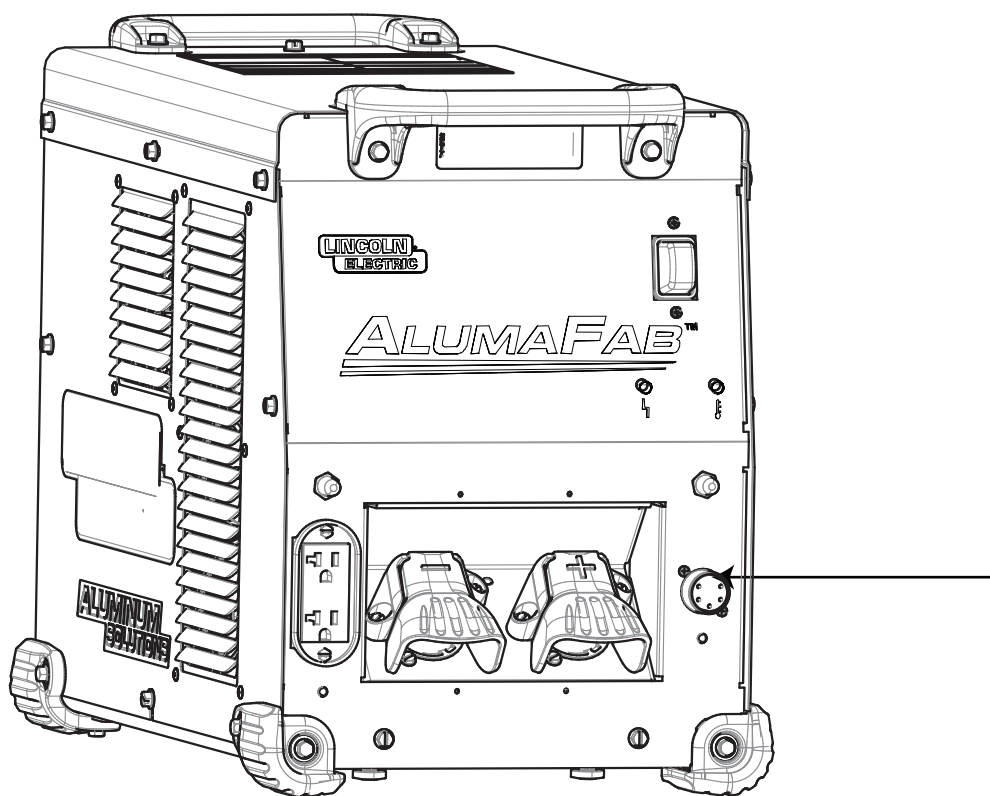

ArcLink Wire Feeder & Digital Accessory Connectivity

Picture	Function	Pin	Wiring
	5-pin connector for wire feeder connectivity.	A	ArcLink CAN
		B	ArcLink CAN
		C	Electrode Sense Lead
		D	40Vdc
		E	40Vdc Common

RECOMMENDED ELECTRODE AND WORK CABLE SIZES FOR ARC WELDING

General Guidelines

Connect the electrode and work cables between the appropriate output studs of the Alumafab™ per the following guidelines:

- Most welding applications run with the electrode being positive (+). For those applications, connect the electrode cable between the wire drive feed plate and the positive (+) output stud on the power source. Connect a work lead from the negative (-) power source output stud to the work piece.
- When negative electrode polarity is required, such as in some Innershield applications, reverse the output connections at the power source (electrode cable to the negative (-) stud, and work cable to the positive (+) stud).

The following recommendations apply to all output polarities and weld modes:

- **Select the appropriate size cables per the “Output Cable Guidelines” below.** Excessive voltage drops caused by undersized welding cables and poor connections often result in unsatisfactory welding performance. Always use the largest welding cables (electrode and work) that are practical, and be sure all connections are clean and tight.

Note: Excessive heat in the weld circuit indicates undersized cables and/or bad connections.

- **Route all cables directly to the work and wire feeder, avoid excessive lengths and do not coil excess cable.** Route the electrode and work cables in close proximity to one another to minimize the loop area and therefore the inductance of the weld circuit.

- **Always weld in a direction away from the work (ground) connection.**

OUTPUT CABLE GUIDELINES

AMPERES	PERCENT DUTY CYCLE	CABLE SIZES FOR COMBINED LENGTHS OF ELECTRODE AND WORK CABLES [RUBBER COVERED COPPER - RATED 167°F (75°C)]**				
		0 TO 50 FT	50 TO 100 FT	100 - 150 FT	150 - 200 FT	200 - 250 FT
200	60	2	2	2	1	1/0
200	100	2	2	2	1	1/0
250	30	3	3	2	1	1/0
250	40	2	2	1	1	1/0
250	60	1	1	1	1	1/0
250	100	1	1	1	1	1/0
300	60	1	1	1	1/0	2/0
300	100	2/0	2/0	2/0	2/0	3/0
350	40	1/0	1/0	2/0	2/0	3/0
400	60	2/0	2/0	2/0	3/0	4/0
400	100	3/0	3/0	3/0	3/0	4/0
500	60	2/0	2/0	3/0	3/0	4/0

CONTROL CABLE AND VOLTAGE SENSING CONNECTIONS

General Guidelines

Genuine Lincoln control cables should be used at all times (except where noted otherwise). Lincoln cables are specifically designed for the communication and power needs of the Alumafab™. Most are designed to be connected end-to-end for ease of extension.

Generally, it is recommended that the total length not exceed 100 feet (30.5 m). The use of non-standard cables, especially in lengths greater than 25 feet, can lead to communication problems (system shutdowns), poor motor acceleration (poor arc starting), and low wire driving force (wire feeding problems). Always use the shortest length of control cable possible, and DO NOT coil excess cable.

Regarding cable placement, best results will be obtained when control cables are routed separate from the weld cables. This minimizes the possibility of interference between the high currents flowing through the weld cables, and the low level signals in the control cables.

Voltage Sensing Overview

The best arc performance occurs when the Alumafab™ has accurate data about the arc conditions. Depending upon the process, inductance within the electrode and work cables can influence the voltage apparent at the studs of the welder, and have a dramatic effect on performance. A remote electrode voltage sense lead is used to improve the accuracy of the arc voltage information supplied to the machine. The electrode sense lead is integral to the ArcLink control cable.

General Guidelines for Voltage Sense Leads

Sense leads should be attached as close to the weld as practical, and out of the weld current path when possible. In extremely sensitive applications it may be necessary to route cables that contain the sense leads away from the electrode and work welding cables.

Voltage sense leads requirements are based on the weld process as follows when in "ArcLink" mode position:

PROCESS	ELECTRODE VOLTAGE SENSING ¹	WORK VOLTAGE SENSING ²
GMAW	67 LEAD	VOLTAGE SENSE AT STUDS
GMAW-P	67 LEAD	VOLTAGE SENSE AT STUDS

1. The electrode voltage sense lead (67) is automatically enabled by the weld process, and integral to the 5-pin ArcLink control cable.

Electrode Voltage Sensing

The remote ELECTRODE sense lead (67) is built into the 5-pin ArcLink control cable (K1543-xx) and is always connected to the wire drive feed plate when a wire feeder is present.

**PF84 SETUP
WITH ALUMAFAB**

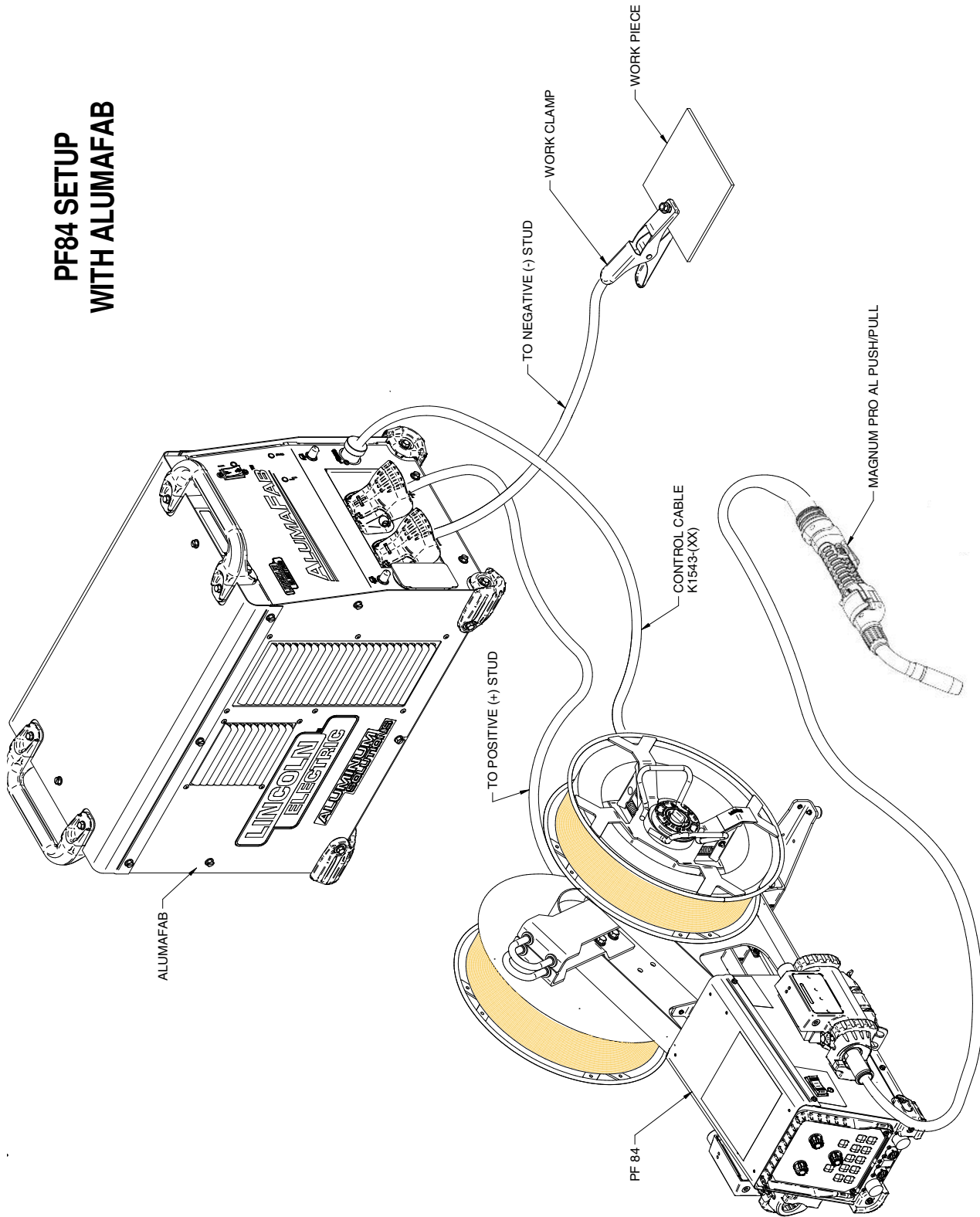

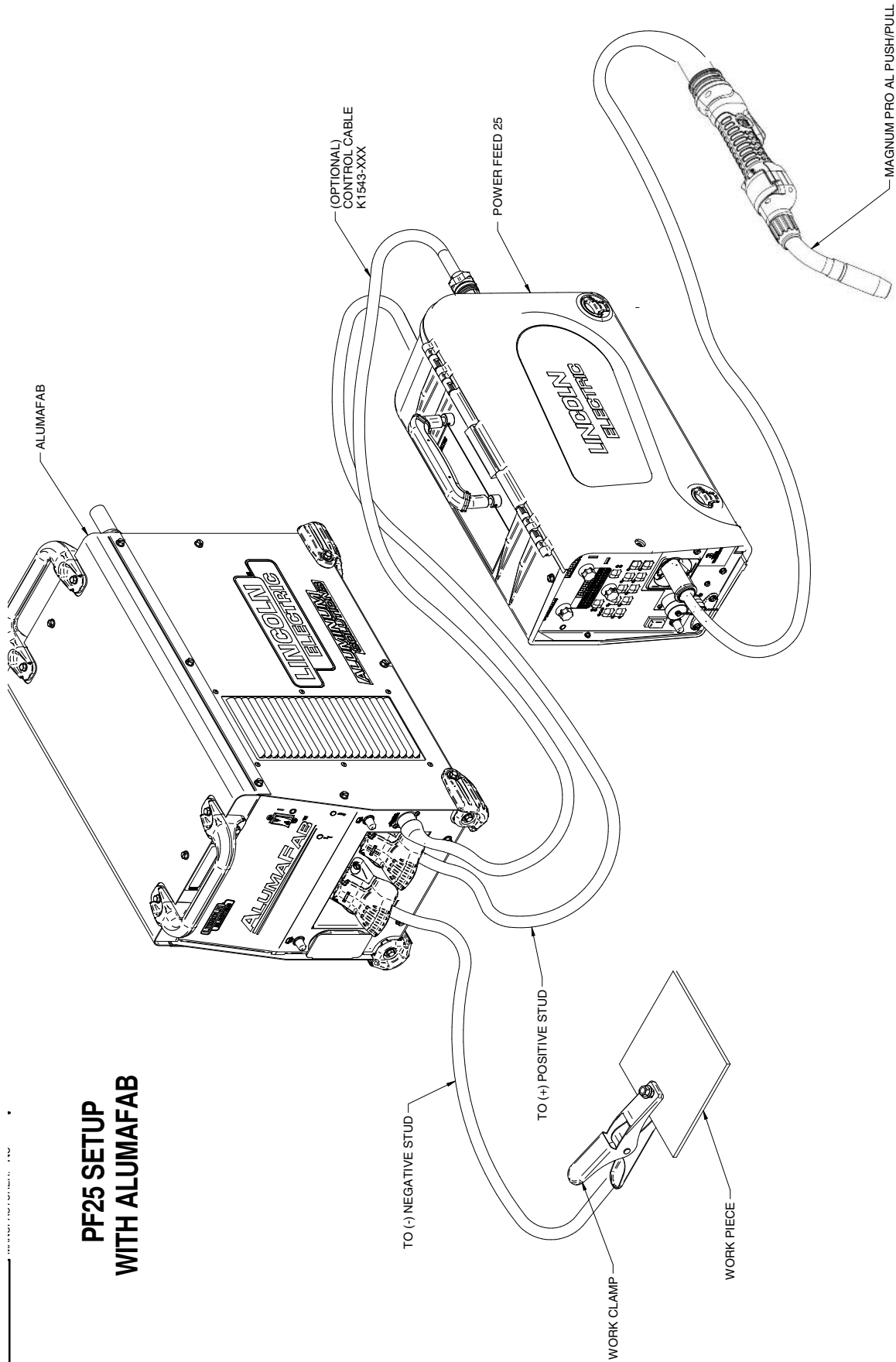

















**PF25 SETUP
WITH ALUMAFAB**

OPERATION

GRAPHIC SYMBOLS THAT APPEAR ON THIS MACHINE OR IN THIS MANUAL

	INPUT POWER	U_r	RATED REDUCED NO-LOAD VOLTAGE
	ON	U_0	OPEN CIRCUIT VOLTAGE
	OFF	U_1	INPUT VOLTAGE
	HIGH TEMPERATURE	U_2	OUTPUT VOLTAGE
	MACHINE STATUS	I_1	INPUT CURRENT
	CIRCUIT BREAKER	I_2	OUTPUT CURRENT
	WIRE FEEDER		PROTECTIVE GROUND
	POSITIVE OUTPUT		WARNING OR CAUTION
	NEGATIVE OUTPUT		EXPLOSION
	3 PHASE INVERTER		DANGEROUS VOLTAGE
	INPUT POWER		SHOCK HAZARD
$3 \sim$	THREE PHASE		
	DIRECT CURRENT		

POWER-UP SEQUENCE



WARNING



ELECTRIC SHOCK can kill.

UNLESS USING COLD FEED FEATURE, WHEN FEEDING WITH GUN TRIGGER, THE ELECTRODE AND DRIVE MECHANISM ARE ALWAYS ELECTRICALLY ENERGIZED AND COULD REMAIN ENERGIZED SEVERAL SECONDS AFTER THE WELDING CEASES.



FUMES AND GASES can be dangerous to your health.

- Keep your head out of fumes.
- Use ventilation or exhaust to remove fumes from breathing zone.



WELDING SPARKS can cause fire or explosion.

- Keep flammable material away.
- Do not weld on closed containers.



ARC RAYS can burn eyes and skin.

- Wear eye, ear and body protection.

- **SEE ADDITIONAL WARNING INFORMATION UNDER “ARC WELDING SAFETY PRECAUTIONS” ON INSIDE OF FRONT COVER OF OPERATING MANUAL.**

When power is applied to the Alumafab™ the machine electronics will complete a power up sequence. An ArcLink wire feeder present and connected to the 5-pin circular connector will initialize and begin a power up sequence once power is applied to the machine.

DUTY CYCLE

The Alumafab™ is capable of welding at a 100% duty cycle (continuous welding) at 450 Amps rated output.

The 60% duty cycle rating is 500 amps (based off of a ten minute cycle – 6 minutes on time and 4 minutes off time). The maximum output of the machine is 500 amps.

The Alumafab™ is also rated for Desert Duty, elevated temperature operation, in a 55°C ambient. The machine is de-rated for this application.

DEFINITION OF WELDING MODES

SYNERGIC WELDING MODES

Synergic welding mode offers simplicity of a single knob control. The machine will select the correct voltage and amperage based on the wire feed speed (WFS) set by the operator.

WELD CONTROLS AND DISPLAYS

Output Control Dial on the Feeder

Output control is conducted via a single turn potentiometer.

Adjustment is indicated by the meters.

When in remote modes, this control sets the maximum welding current or voltage output. Full depression of a foot or hand amptrol results in the preset level of current or voltage.

Volt Display Meter on the Feeder

- Prior to CV operation (current flow), the meter displays desired preset voltage value (+/- .1V).
- During welding, this meter displays actual average volts.
- After welding, the meter holds the actual voltage value for 5 seconds. The displays blink indicating that the machine is in the "Hold" period.
- Output adjustment while in the "hold" period results in the "prior to operation" characteristics.

Amperage Display Meter on the Feeder

- Prior to CV operation, the meter displays four dashes indicating non-presettable AMPS.
- During welding, this meter displays actual average amps.
- After welding, the meter holds the actual current value for 5 seconds. The displays blink indicating that the machine is in the "Hold" period.
- Output adjustment while in the "hold" period results in the "prior to operation" characteristics

Thermal Light

- This status light indicates when the power source has been driven into thermal overload. If the output terminals were "ON", the output will be turned back on once the unit cools down to an acceptable temperature level. If the unit was operating in the "REMOTE" mode, the trigger will need to be opened before or after the thermal has cleared and closed after the machine has cooled down to an acceptable temperature to re-establish output.

PULSE WELDING

Pulse welding procedures are set by controlling an overall “arc length” variable. When pulse welding, the arc voltage is highly dependent upon the waveform. The peak current, back ground current, rise time, fall time and pulse frequency all affect the voltage. The exact voltage for a given wire feed speed can only be predicted when all the pulsing waveform parameters are known. Using a preset voltage becomes impractical and instead the arc length is set by adjusting “trim” via the ArcLink compatible wire feeder for a given wire feed speed setting.

Trim adjusts the arc length and ranges from 0.50 to 1.50 with a nominal value of 1.00. Trim values greater than 1.00 increase the arc length, while values less than 1.00 decrease the arc length.

(See Figure C.2)

Figure C.2

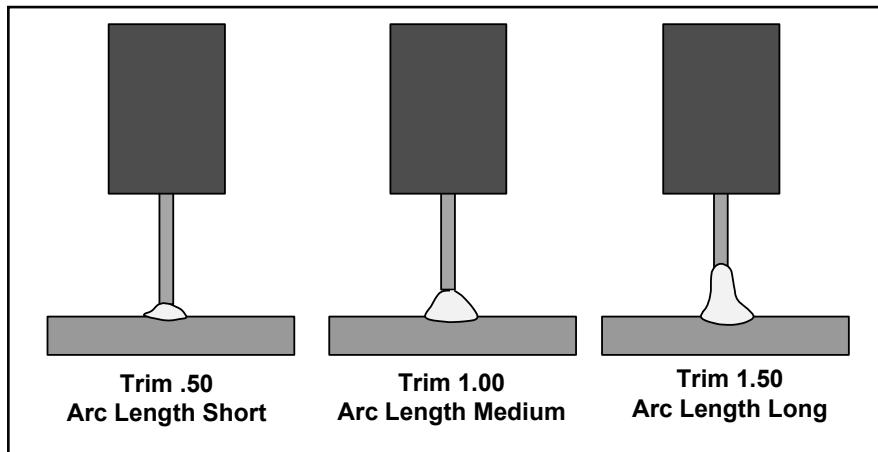

All pulse welding programs in the Alumafab™ are synergic. As the wire feed speed is adjusted, the Alumafab™ will automatically recalculate the waveform parameters to maintain similar arc properties.

The Alumafab™ utilizes “adaptive control” to compensate for changes in the electrical stick-out while welding. (Electrical stick-out is the distance from the contact tip to the work piece.) The Alumafab™ waveforms are optimized for a 0.75” stick-out. The adaptive behavior supports a range of stick-outs from 0.50 to 1.25”. At very low or high wire feed speeds, the adaptive range may be less due to reaching physical limitations of the welding process.

Additionally, the Alumafab™ offers “CC Pulse” modes. These modes disable the adaption features of the standard pulse modes. Adjusting the trim knob will increase or decrease the arc length by adjusting the average amperage.

The Alumafab™ welding modes utilize the UltimArc™ Arc Control Feature for adjusting the focus or shape of the arc. UltimArc™ Control is adjustable from -10.0 to +10.0 with a nominal setting of 0.0. **(See Figure C.3)** Increasing the UltimArc™ Control increases the pulse frequency and background current while decreasing the peak current. This results in a tight, stiff arc used for high speed sheet metal welding. Decreasing the UltimArc™ Control decreases the pulse frequency and background current while increasing the peak current. This results in a soft arc good for out of position welding.

The UltimArc™ Arc Control can be accessed through the ArcLink compatible wire feeder user interface.

For additional information about UltimArc™ Arc Controls and pulse welding procedure Lincoln Electric publishes process documents as informational guides on various welding procedures. Access to the process documents can be attained at the following web address: <http://www.lincolnelectric.com/en-us/equipment/advanced-process-welders/Pages/power-wave-resources.aspx>

Figure C.3

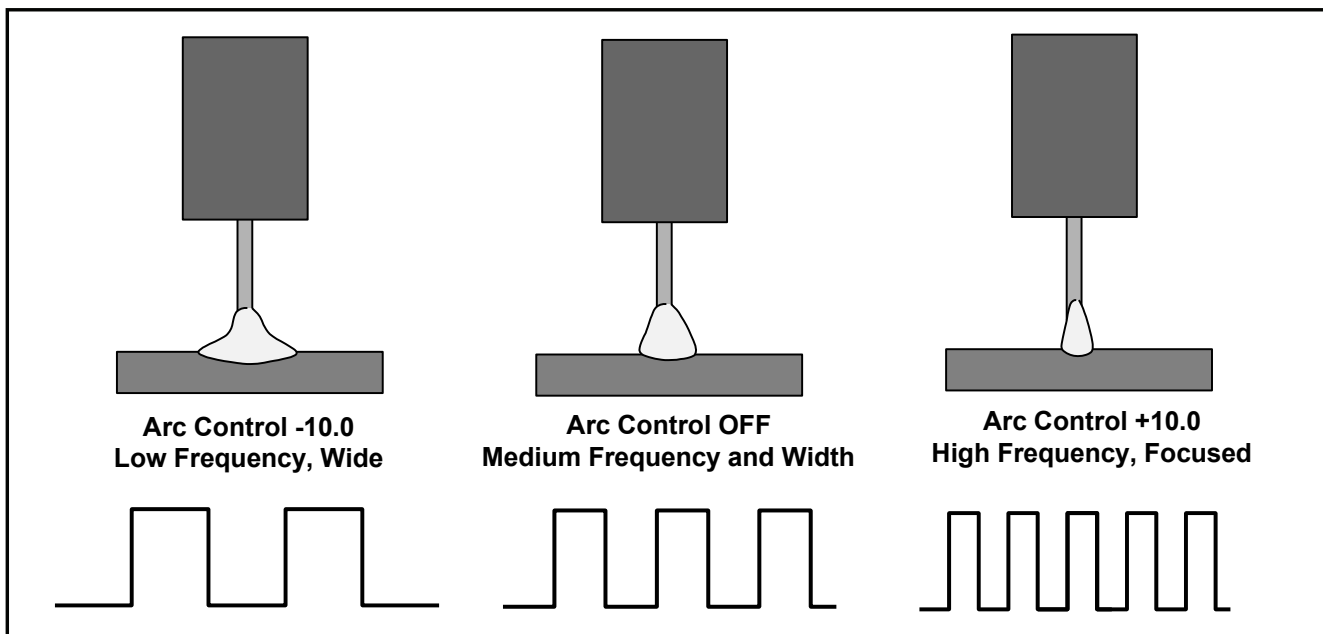

ACCESSORIES

GENERAL OPTIONS

K2149-1 Work Lead Package. 4/0 cable lugged at one end with work clamp attached at the other end. 15 ft. (4.6 m) length.

K1842-10 Weld Power Cable. Lug to lug, 3/0, 600A, 60% duty cycle. 10 ft. (3.0 m).

K3059-2 Inverter and Wire Feeder Cart. Rear-wheeled cart with front casters and gas bottle platform. Convenient handles allow for easy cable storage. Small footprint fits through 30 in. (762 mm) door. Not intended for use with double head wire feeders.

K3059-3 Dual Cylinder Inverter & Wire Feeder Cart. Rear-wheeled cart with front casters and dual cylinder platform. Convenient handles allow for easy cable storage. Small footprint fits through 30 inch (762mm) door.

K586-1 Deluxe Adjustable Gas Regulator & Hose Kit. Accommodates Argon, or Argon-blend gas cylinders. Includes a cylinder pressure gauge, dual scale flow gauge and 4.3ft (1.3m) gas hose.

K2909-1 12-pin to 6-pin Adapter

K2910-1 7-pin to 12-pin Adapter

FUME EXTRACTING SYSTEMS

3100211 Harris Argon Flowmeter Regulator and Hose Kit

K3019-1 Arc Tracker. The Arc Tracker monitors information regarding your welding arc by connecting it between any DC welding power source and the work clamp.

Weld Fume Control Solutions. Lincoln Electric offers a wide variety of welding fume control solutions, ranging from portable systems easily wheeled around the shop to shop-wide central systems servicing many dedicated welding stations.

MAINTENANCE



WARNING



ELECTRIC SHOCK can kill.

- Before carrying out service, maintenance and/or repair jobs, fully disconnect power to the machine.
- Do not touch electrically hot parts.



Only Qualified personnel should perform this maintenance.

PERIODIC MAINTENANCE

Thermal Protection

Thermostats protect the machine from excessive operating temperatures. Excessive temperatures may be caused by a lack of cooling air or operating the machine beyond the duty cycle and output rating. If excessive operating temperature should occur, the thermostat will disable the output and run the cooling fan. The displays on an attached feeder will remain energized during this time and the thermal light will be illuminated. Thermostats are self-resetting once the machine cools sufficiently. If the thermostat shutdown was caused by excessive output or duty cycle and the fan is operating normally, the Power Switch may be left on and the reset should occur within a 15 minute period.

VISUAL INSPECTION

Clean interior of machine with a low pressure air stream. Make a thorough inspection of all components.

Look for signs of overheating, broken leads or other obvious problems. Many problems can be uncovered with a good visual inspection.

ROUTINE MAINTENANCE

Every six months the machine should be cleaned with a low pressure air stream. Keeping the machine clean will result in cooler operation and higher reliability. Be sure to clean the following areas:

- All printed circuit boards
- Power switch
- Main transformer
- Input rectifier
- Heatsink fins
- Auxiliary Transformer
- Reconnect Switch Area
- Fan (Blow air through the rear louvers)

Examine the sheet metal case for dents or breakage. Repair the case as required. Keep the case in good condition to ensure that high voltage parts are protected and correct spacing is maintained throughout. All external sheet metal screws must be in place to ensure case strength and electrical ground continuity.



If for any reason you do not understand the procedures or are unable to perform the maintenance or repairs safely, contact your Lincoln Authorized Service Facility for technical troubleshooting assistance before you proceed.

WWW.LINCOLNELECTRIC.COM/LOCATOR

TROUBLESHOOTING

HOW TO USE TROUBLESHOOTING GUIDE



WARNING

Service and Repair should only be performed by Lincoln Electric Factory Trained Personnel. Unauthorized repairs performed on this equipment may result in danger to the technician and machine operator and will invalidate your factory warranty. For your safety and to avoid Electrical Shock, please observe all safety notes and precautions detailed throughout this manual.

This Troubleshooting Guide is provided to help you locate and repair possible machine malfunctions. Simply follow the three-step procedure listed below.

Step 1. LOCATE PROBLEM (SYMPTOM).

Look under the column labeled “PROBLEM (SYMPTOMS)”. This column describes possible symptoms that the machine may exhibit. Find the listing that best describes the symptom that the machine is exhibiting.

Step 2. POSSIBLE CAUSE.

The second column labeled “POSSIBLE CAUSE” lists the obvious external possibilities that may contribute to the machine symptom.

Step 3. RECOMMENDED COURSE OF ACTION

This column provides a course of action for the Possible Cause, generally it states to contact your local Lincoln Authorized Field Service Facility.

If you do not understand or are unable to perform the Recommended Course of Action safely, contact your local Lincoln Authorized Field Service Facility.



CAUTION

If for any reason you do not understand the test procedures or are unable to perform the tests/repairs safely, contact your **Local Lincoln Authorized Field Service Facility** for technical troubleshooting assistance before you proceed.

ERROR CODES

Errors are displayed on the user interface. In addition, there are status lights on the User Interface PC board on an attached feeder and the Switch PC board that contain error sequences.

Included in this section is information about the status lights and some basic troubleshooting charts for both machine and weld performance.

The status lights on the User Interface board and the Switch board are dual-color LED's. Normal operation for each is steady green.

Error conditions are indicated in the following chart.

Error Code	Description	Corrective Action
6	No CAN messages from Power Source	Communication from the Power Source failed before mapping was complete.
18	ArcLink Auto-Mapping Failed	The machine could not properly configure the devices that are attached to it. This configuration problem could be caused by the type of devices that are connected to the machine or a required device that is not connected.
21	Device that controls sequence of the welding operation halted due to an error	A component of the system encountered an error during the welding sequence and caused the system to stop. The component with the error could be a wire drive, a user interface or some other part of the system.
31	Primary Overcurrent	Peak current through the transformer primary has exceeded its threshold.
36	Thermal Fault	Machine shutoff output due to elevated internal temperature.
45	Output Voltage Limit Exceeded	During OCV, the voltage at the studs exceeded the allowable levels.
213	Communication Fault	CAN communication between the User Interface PC board and the Switch PC board has been interrupted.
711	DC Link Capacitor Over/Under Voltage	The voltage on the main DC link capacitors housed on the switchboard has either gone too high or too low.
713	Misconnect Protection - UI detected Aux. Trans. Voltage too high	Occurs upon power up when the supply voltage to the User Interface PC board exceeds an acceptable level.
714	Misconnect Protection - UI detected Aux. Trans. Voltage too low	Occurs upon power up when the supply voltage to the User Interface PC board is below an acceptable level.
719	Switch PC Board Error	The Switch PC board experienced an internal error.
If any of these conditions persist contact an authorized Lincoln Field Service Shop.		



CAUTION

If for any reason you do not understand the test procedures or are unable to perform the tests/repairs safely, contact your **Local Lincoln Authorized Field Service Facility** for technical troubleshooting assistance before you proceed.

Observe all Safety Guidelines detailed throughout this manual

PROBLEMS (SYMPTOMS)	POSSIBLE CAUSE	RECOMMENDED COURSE OF ACTION
Major physical or electrical damage is evident when the sheet metal covers are removed.	1. Contact your local authorized Lincoln Electric Field Service facility for technical assistance.	1. If all recommended possible areas of mis-adjustment have been checked and the problem persists, Contact your local Lincoln Authorized Field Service Facility.
Machine won't weld, can't get any output.	1. If the displays on an attached feedershow an Err ### see the fault section for corrective action. 2 If the thermal symbol is lit refer to the thermal section. 3 If the output terminals are in remote control switch to "ON" and check for output voltage. If output voltage is now present check for correct remote control connection and operation.	
Thermal symbol is lit	1. Check for proper fan operation. - Check for material blocking intake or exhaust louvers. - Blow air in the rear louvers to clear dirt from the fan. Note: The Fan As Needed circuitry automatically shuts off the fan 5 minutes after welding has stopped. 2. Welding output ratings may have been exceeded. Allow the machine to cool down and reset.	
Wire feeder won't work. Apparently no power to wire feeder	1. Check the 42V or ArcLink connectors on the case front of the machine to make sure it is properly connected. 2. Check circuit breakers by the wire feeder receptacles on the case front of the machine. Reset if necessary. 3. Check the control cable between the power source and the wire feeder for continuity.	

 **CAUTION**

If for any reason you do not understand the test procedures or are unable to perform the tests/repairs safely, contact your **Local Lincoln Authorized Field Service Facility** for technical troubleshooting assistance before you proceed.

ALUMAFAB WIRING DIAGRAM (CODE 12374, 12566)

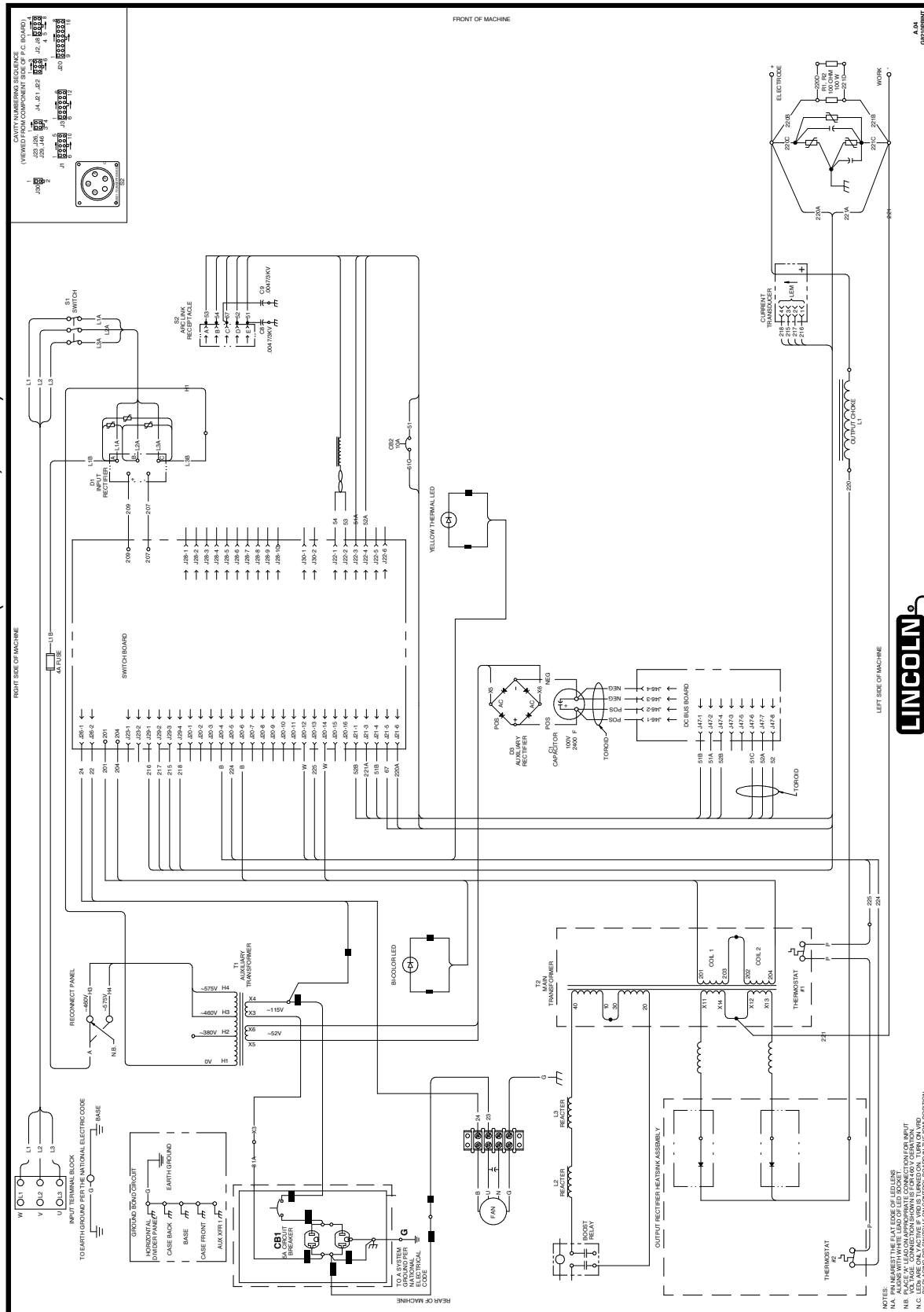

NOTE: This diagram is for reference only. It may not be accurate for all machines covered by this manual. The specific diagram for a particular code is pasted inside the machine on one of the enclosure panels. If the diagram is illegible, write to the Service Department for a replacement. Give the equipment code number.

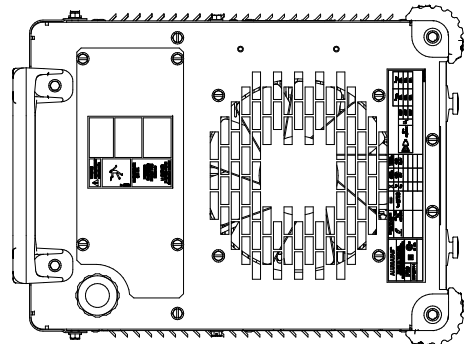
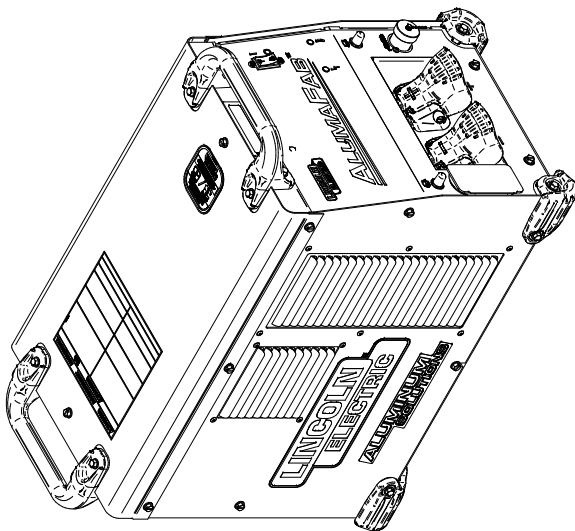
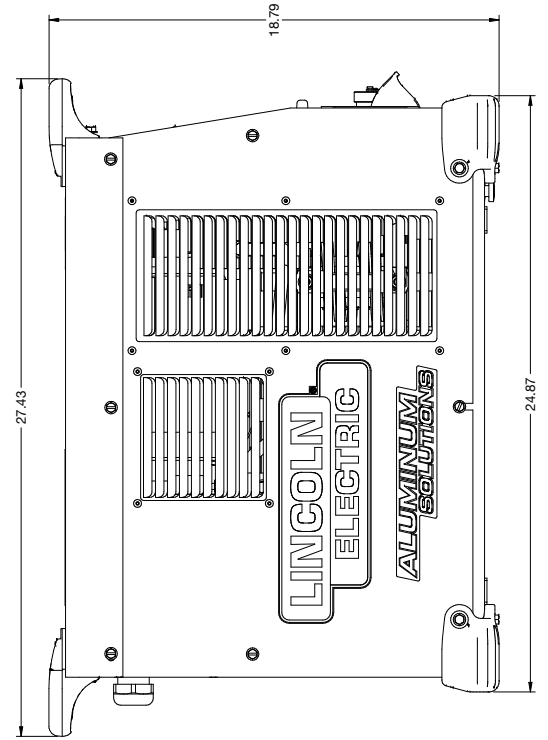
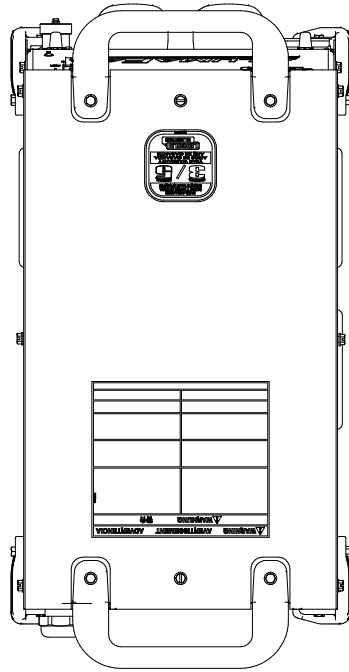
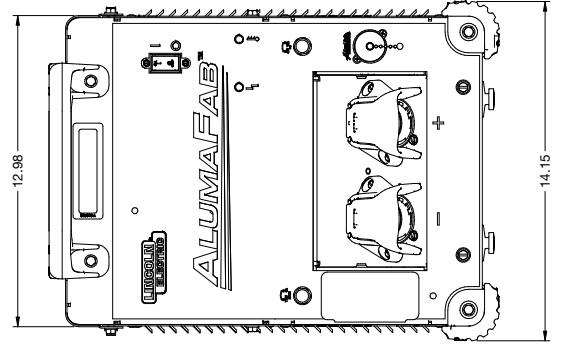
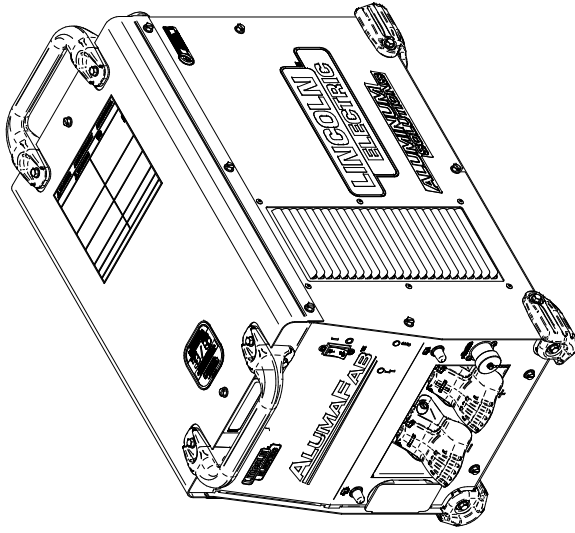

NOTE: This diagram is for reference only. It may not be accurate for all machines covered by this manual. The specific diagram for a particular code is pasted inside the machine on one of the enclosure panels. If the diagram is illegible, write to the Service Department for a replacement. Give the equipment code number.

			
WARNING	<ul style="list-style-type: none"> Do not touch electrically live parts or electrode with skin or wet clothing. Insulate yourself from work and ground. 	<ul style="list-style-type: none"> Keep flammable materials away. 	<ul style="list-style-type: none"> Wear eye, ear and body protection.
Spanish AVISO DE PRECAUCION	<ul style="list-style-type: none"> No toque las partes o los electrodos bajo carga con la piel o ropa mojada. Aíslese del trabajo y de la tierra. 	<ul style="list-style-type: none"> Mantenga el material combustible fuera del área de trabajo. 	<ul style="list-style-type: none"> Protéjase los ojos, los oídos y el cuerpo.
French ATTENTION	<ul style="list-style-type: none"> Ne laissez ni la peau ni des vêtements mouillés entrer en contact avec des pièces sous tension. Isolez-vous du travail et de la terre. 	<ul style="list-style-type: none"> Gardez à l'écart de tout matériel inflammable. 	<ul style="list-style-type: none"> Protégez vos yeux, vos oreilles et votre corps.
German WARNUNG	<ul style="list-style-type: none"> Berühren Sie keine stromführenden Teile oder Elektroden mit Ihrem Körper oder feuchter Kleidung! Isolieren Sie sich von den Elektroden und dem Erdboden! 	<ul style="list-style-type: none"> Entfernen Sie brennbares Material! 	<ul style="list-style-type: none"> Tragen Sie Augen-, Ohren- und Körperschutz!
Portuguese ATENÇÃO	<ul style="list-style-type: none"> Não toque partes elétricas e electrodos com a pele ou roupa molhada. Isole-se da peça e terra. 	<ul style="list-style-type: none"> Mantenha inflamáveis bem guardados. 	<ul style="list-style-type: none"> Use proteção para a vista, ouvido e corpo.
Japanese 注意事項	<ul style="list-style-type: none"> 通電中の電気部品、又は溶材にヒブやぬれた布で触れないこと。 施工物やアースから身体が絶縁されている様にして下さい。 	<ul style="list-style-type: none"> 燃えやすいものの側での溶接作業は絶対にしてはなりません。 	<ul style="list-style-type: none"> 目、耳及び身体に保護具をして下さい。
Chinese 警告	<ul style="list-style-type: none"> 皮肤或湿衣物切勿接触带电部件及焊条。 使你自已与地面和工件绝缘。 	<ul style="list-style-type: none"> 把一切易燃物品移离工作场所。 	<ul style="list-style-type: none"> 佩戴眼、耳及身体劳动保护用具。
Korean 위험	<ul style="list-style-type: none"> 전도체나 용접봉을 젖은 헝겍 또는 피부로 절대 접촉치 마십시오. 모재와 접지를 접촉치 마십시오. 	<ul style="list-style-type: none"> 인화성 물질을 접근시키지 마십시오. 	<ul style="list-style-type: none"> 눈, 귀와 몸에 보호장구를 착용하십시오.
Arabic تحذير	<ul style="list-style-type: none"> لا تلمس الاجزاء التي يسري فيها التيار الكهربائي أو الألكترود بجسدك أو بالملابس المبللة بالماء. ضع عازلا على جسمك خلال العمل. 	<ul style="list-style-type: none"> ضع المواد القابلة للاشتعال في مكان بعيد. 	<ul style="list-style-type: none"> ضع أدوات وملابس واقية على عينيك وأذنيك وجسمك.

READ AND UNDERSTAND THE MANUFACTURER'S INSTRUCTION FOR THIS EQUIPMENT AND THE CONSUMABLES TO BE USED AND FOLLOW YOUR EMPLOYER'S SAFETY PRACTICES.

SE RECOMIENDA LEER Y ENTENDER LAS INSTRUCCIONES DEL FABRICANTE PARA EL USO DE ESTE EQUIPO Y LOS CONSUMIBLES QUE VA A UTILIZAR, SIGA LAS MEDIDAS DE SEGURIDAD DE SU SUPERVISOR.

LISEZ ET COMPRENEZ LES INSTRUCTIONS DU FABRICANT EN CE QUI REGARDE CET EQUIPMENT ET LES PRODUITS A ETRE EMPLOYES ET SUIVEZ LES PROCEDURES DE SECURITE DE VOTRE EMPLOYEUR.

LESEN SIE UND BEFOLGEN SIE DIE BETRIEBSANLEITUNG DER ANLAGE UND DEN ELEKTRODENEINSATZ DES HERSTELLERS. DIE UNFALLVERHÜTUNGSVORSCHRIFTEN DES ARBEITGEBERS SIND EBENFALLS ZU BEACHTEN.

			
<ul style="list-style-type: none"> ● Keep your head out of fumes. ● Use ventilation or exhaust to remove fumes from breathing zone. 	<ul style="list-style-type: none"> ● Turn power off before servicing. 	<ul style="list-style-type: none"> ● Do not operate with panel open or guards off. 	WARNING
<ul style="list-style-type: none"> ● Los humos fuera de la zona de respiración. ● Mantenga la cabeza fuera de los humos. Utilice ventilación o aspiración para gases. 	<ul style="list-style-type: none"> ● Desconectar el cable de alimentación de poder de la máquina antes de iniciar cualquier servicio. 	<ul style="list-style-type: none"> ● No operar con panel abierto o guardas quitadas. 	Spanish AVISO DE PRECAUCION
<ul style="list-style-type: none"> ● Gardez la tête à l'écart des fumées. ● Utilisez un ventilateur ou un aspirateur pour ôter les fumées des zones de travail. 	<ul style="list-style-type: none"> ● Débranchez le courant avant l'entretien. 	<ul style="list-style-type: none"> ● N'opérez pas avec les panneaux ouverts ou avec les dispositifs de protection enlevés. 	French ATTENTION
<ul style="list-style-type: none"> ● Vermeiden Sie das Einatmen von Schweißrauch! ● Sorgen Sie für gute Be- und Entlüftung des Arbeitsplatzes! 	<ul style="list-style-type: none"> ● Strom vor Wartungsarbeiten abschalten! (Netzstrom völlig öffnen; Maschine anhalten!) 	<ul style="list-style-type: none"> ● Anlage nie ohne Schutzgehäuse oder Innenschutzverkleidung in Betrieb setzen! 	German WARNUNG
<ul style="list-style-type: none"> ● Mantenha seu rosto da fumaça. ● Use ventilação e exaustão para remover fumo da zona respiratória. 	<ul style="list-style-type: none"> ● Não opere com as tampas removidas. ● Desligue a corrente antes de fazer serviço. ● Não toque as partes elétricas nuas. 	<ul style="list-style-type: none"> ● Mantenha-se afastado das partes moventes. ● Não opere com os painéis abertos ou guardas removidas. 	Portuguese ATENÇÃO
<ul style="list-style-type: none"> ● ヒュームから頭を離すようにして下さい。 ● 換気や排煙に十分留意して下さい。 	<ul style="list-style-type: none"> ● メンテナンス・サービスに取りかかる際には、まず電源スイッチを必ず切して下さい。 	<ul style="list-style-type: none"> ● パネルやカバーを取り外したまま機械操作をしないで下さい。 	Japanese 注意事項
<ul style="list-style-type: none"> ● 頭部遠離煙霧。 ● 在呼吸區使用通風或排風器除煙。 	<ul style="list-style-type: none"> ● 維修前切斷電源。 	<ul style="list-style-type: none"> ● 儀表板打開或沒有安全罩時不準作業。 	Chinese 警告
<ul style="list-style-type: none"> ● 얼굴로부터 용접가스를 멀리하십시오. ● 호흡지역으로부터 용접가스를 제거하기 위해 가스제거기나 통풍기를 사용하십시오. 	<ul style="list-style-type: none"> ● 보수전에 전원을 차단하십시오. 	<ul style="list-style-type: none"> ● 판넬이 열린 상태로 작동치 마십시오. 	Korean 위험
<ul style="list-style-type: none"> ● ابعد رأسك بعيداً عن الدخان. ● استعمل التهوية أو جهاز ضغط الدخان للخارج لكي تبعد الدخان عن المنطقة التي تتنفس فيها. 	<ul style="list-style-type: none"> ● أقطع التيار الكهربائي قبل القيام بأية صيانة. 	<ul style="list-style-type: none"> ● لا تشغيل هذا الجهاز اذا كانت الاغطية الحديدية الواقية ليست عليه. 	Arabic تحذير

LEIA E COMPREENDA AS INSTRUÇÕES DO FABRICANTE PARA ESTE EQUIPAMENTO E AS PARTES DE USO, E SIGA AS PRÁTICAS DE SEGURANÇA DO EMPREGADOR.

使う機械や溶材のメーカーの指示書をよく読み、まず理解して下さい。そして貴社の安全規定に従って下さい。

請詳細閱讀並理解製造廠提供的說明以及應該使用的銀焊材料，並請遵守貴方的有關勞動保護規定。

이 제품에 동봉된 작업지침서를 숙지하시고 귀사의 작업자 안전수칙을 준수하시기 바랍니다.

اقرأ بتمعن وافهم تعليمات المصنع المنتج لهذه المعدات والمواد قبل استعمالها واتبع تعليمات الوقاية لصاحب العمل.

CUSTOMER ASSISTANCE POLICY

The business of The Lincoln Electric Company is manufacturing and selling high quality welding equipment, consumables, and cutting equipment. Our challenge is to meet the needs of our customers and to exceed their expectations. On occasion, purchasers may ask Lincoln Electric for advice or information about their use of our products. We respond to our customers based on the best information in our possession at that time. Lincoln Electric is not in a position to warrant or guarantee such advice, and assumes no liability, with respect to such information or advice. We expressly disclaim any warranty of any kind, including any warranty of fitness for any customer's particular purpose, with respect to such information or advice. As a matter of practical consideration, we also cannot assume any responsibility for updating or correcting any such information or advice once it has been given, nor does the provision of information or advice create, expand or alter any warranty with respect to the sale of our products.

Lincoln Electric is a responsive manufacturer, but the selection and use of specific products sold by Lincoln Electric is solely within the control of, and remains the sole responsibility of the customer. Many variables beyond the control of Lincoln Electric affect the results obtained in applying these types of fabrication methods and service requirements.

Subject to Change – This information is accurate to the best of our knowledge at the time of printing. Please refer to www.lincolnelectric.com for any updated information.



THE LINCOLN ELECTRIC COMPANY

22801 St. Clair Avenue • Cleveland, OH • 44117-1199 • U.S.A.
Phone: +1.216.481.8100 • www.lincolnelectric.com