



## Troubleshooting Guide

# TOMAHAWK® 45

For use with machines having Code Numbers:

**13600**

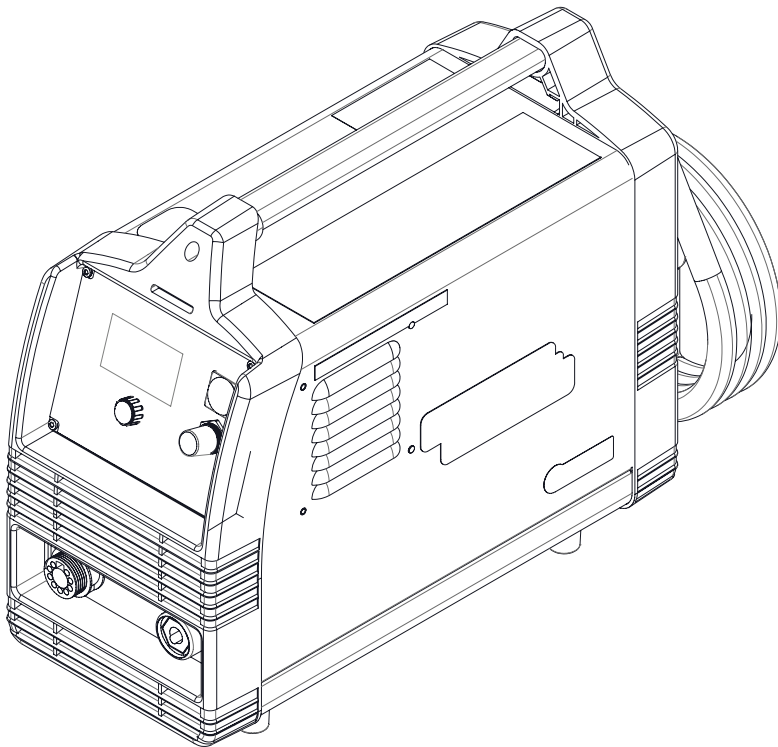

**Register your machine:**

<https://lered.info/locator>

**Authorized Service and Distributor Locator:**

[www.lincolnelectric.com/locator](http://www.lincolnelectric.com/locator)

Save for future reference



# PRODUCT REGISTRATION



Registering your product only takes a few minutes, ensures your qualification for available warranties and allows you to receive updates and information on your product.

Follow the QR code below to register.



**Need Help? Call 1.888.935.3877**  
to talk to a Service Representative

**Hours of Operation:**  
8:00 AM to 6:00 PM (ET) Mon. thru Fri.

**After hours?**  
Use "Ask the Experts" at [lincolnelectric.com](http://lincolnelectric.com)  
A Lincoln Service Representative will contact you no later than the following business day.

**For Service outside the USA:**  
Email: [globalservice@lincolnelectric.com](mailto:globalservice@lincolnelectric.com)

# Tomahawk 45

## Troubleshooting Guide

**Prior to attempting any troubleshooting procedures, please see important safety information starting on page 9.**

Refer to this unit's operators manual for proper Installation and Input power requirements.

If for any reason you do not understand the test procedures or are unable to perform the test/repairs safely please contact Lincoln electric call center at 1-888-935-3877

### SYSTEM CONFIGURATION

Place the machine into the following configuration prior to performing any troubleshooting procedures

1. Check all circuit breakers are not tripped before proceeding to tests.
2. Refer to Operator's Manual for guidances on operation of machine.
3. Connect up compressed air, gas.
4. Set pressure gauge to 90 PSI.
5. Connect up the LC40 torch to the Tomahawk 45.
6. Turn ON the Tomahawk 45.



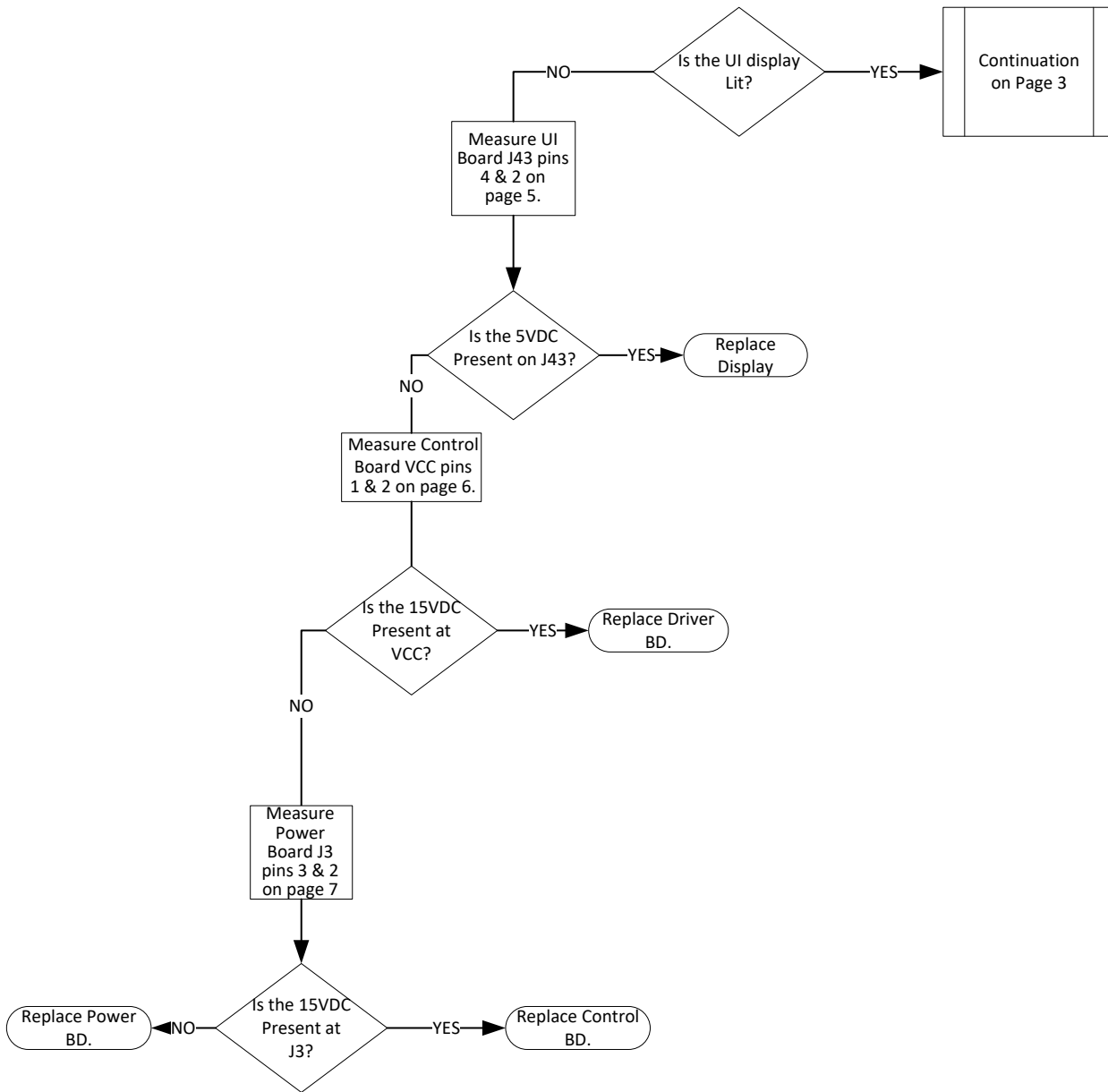

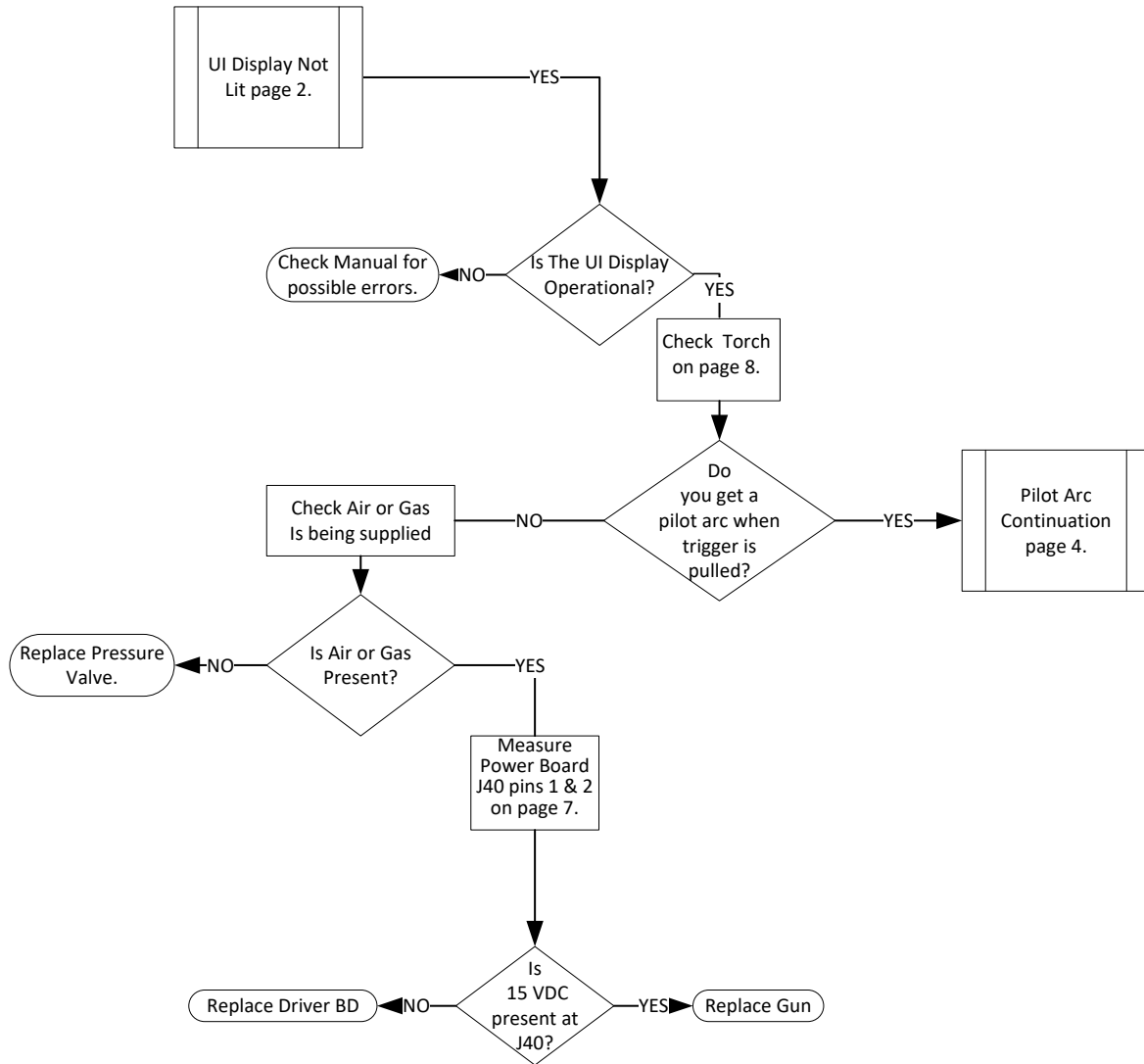

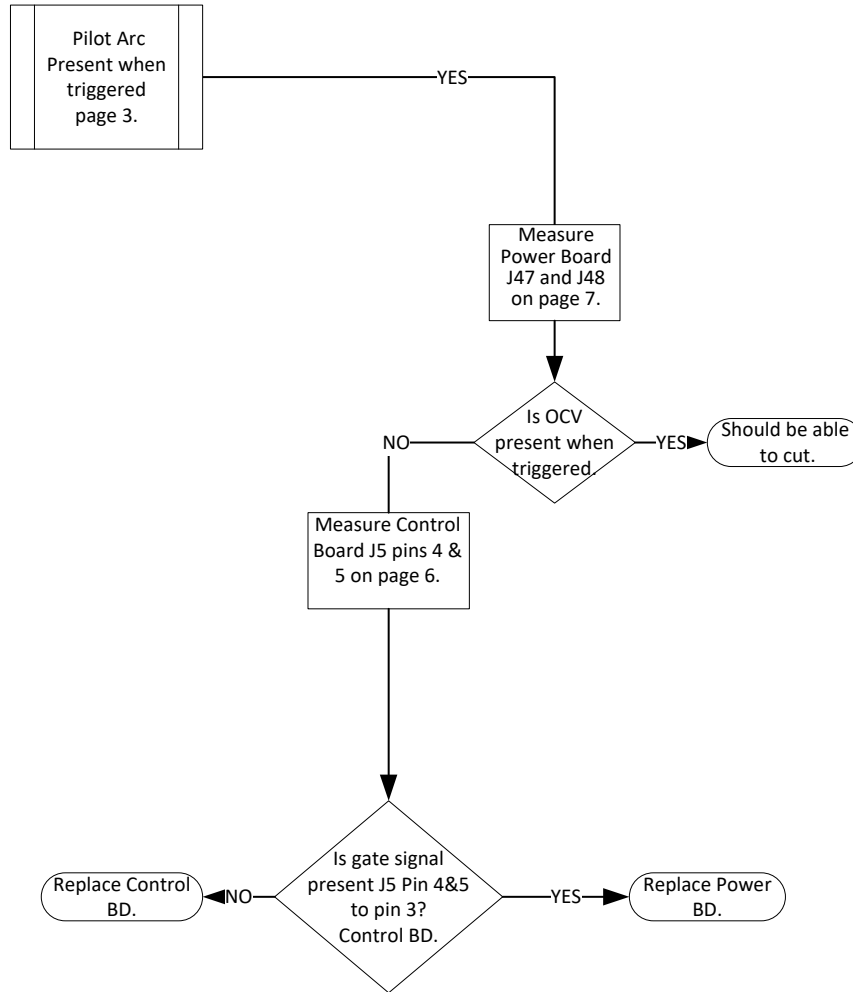

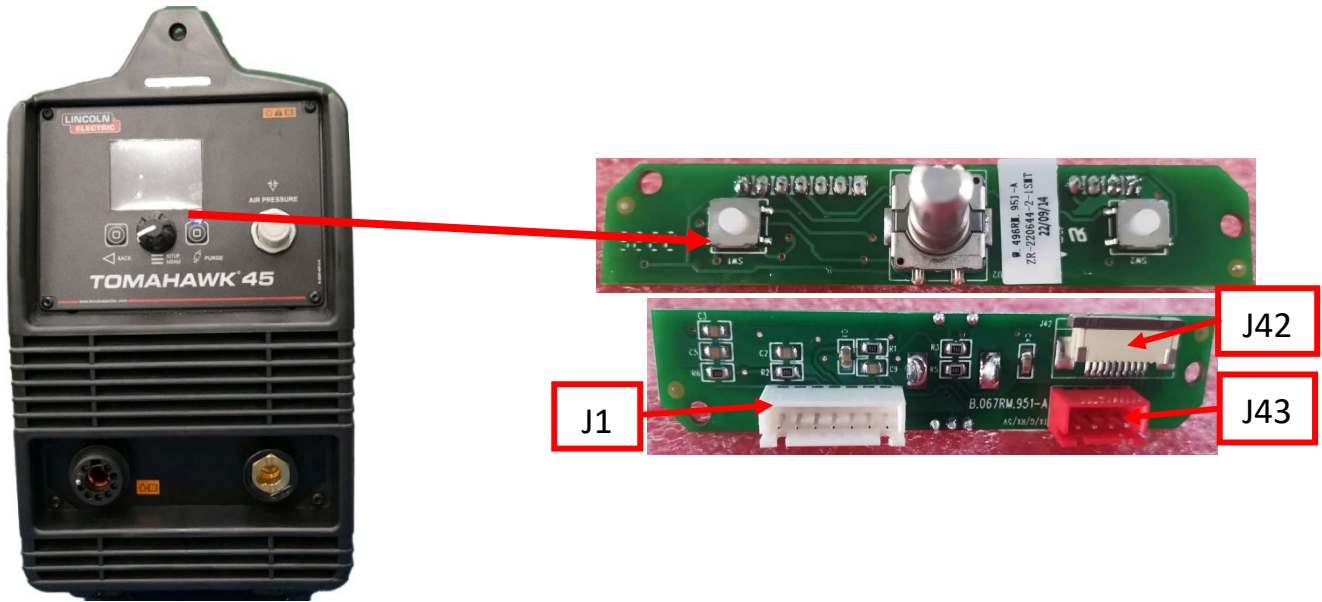

UI Board Test				
Component/Circuit Tested	Condition(s)	+Meter Lead	-Meter Lead	Expected Value
Input	Machine Powered ON.	J43 Pin 4	J43 Pin 2	5 VDC

With machine powered ON, perform the test in table.

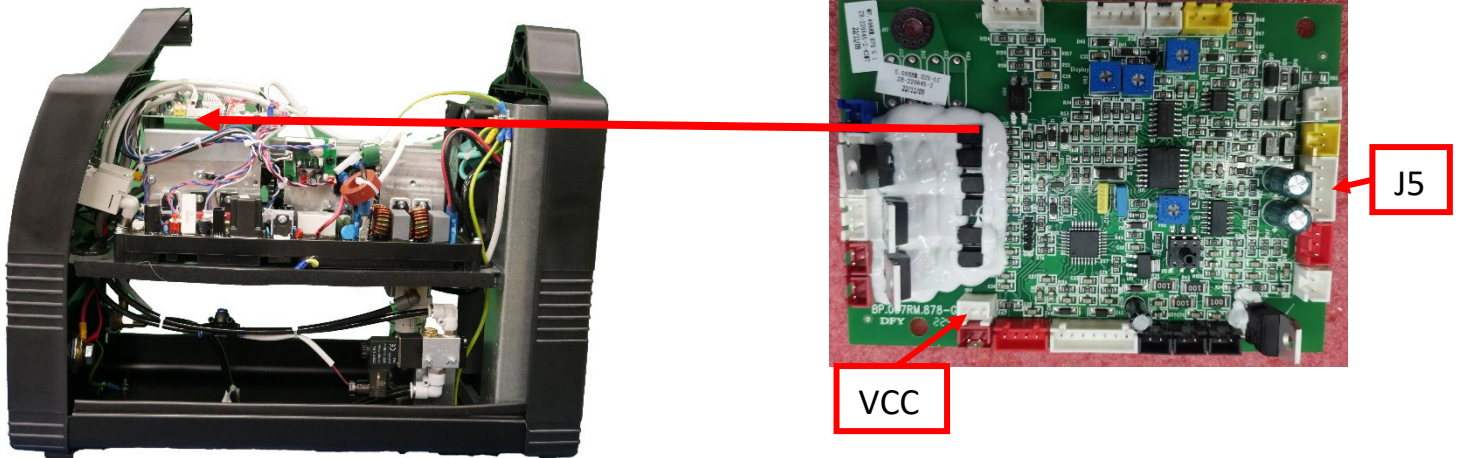

Control Board Test				
Component/Circuit Tested	Condition(s)	+Meter Lead	-Meter Lead	Expected Value
Output Supply to Driver BD.	Machine Powered ON.	VCC Pin 1	VCC Pin 2	~15 VDC
PWM B Gate Drive	Machine Powered ON. Output Enabled.	J5 Pin 5	J5 Pin 3	40 KHz
PWM A Gate Drive		J5 Pin 4	J5 Pin 3	40 KHz

With machine powered perform the test in table 1.

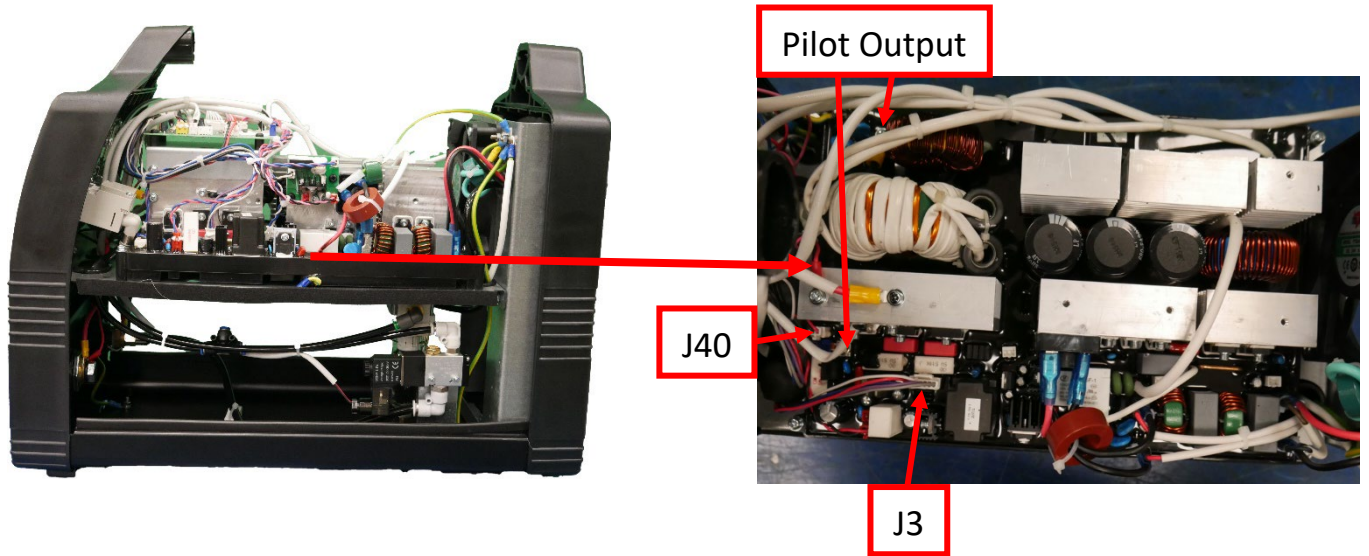

Power Board Test				
Component/Circuit Tested	Condition(s)	+Meter Lead	-Meter Lead	Expected Value
Output Supply Voltages	Machine Powered ON.	J3 Pin 3	J3 Pin 2	~ 15 VDC
Input From Driver PCB		J40 Pin 1	J40 Pin 2	~ 15 VDC
Pilot Output	Machine Powered ON. Output Enabled.	J48	J47	~-155 VDC

With machine turned, perform the test in table.



Gun Back End

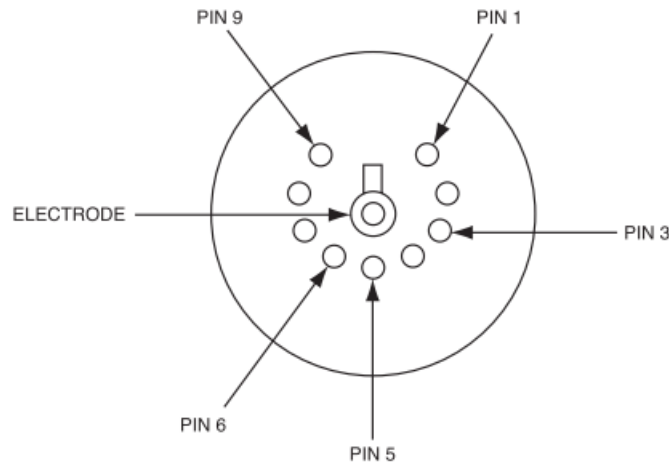

FIG. 1

Torch Static Test				
Component/Circuit Tested	Condition(s)	+Meter Lead	-Meter Lead	Expected Value
Torch Trigger	Trigger Not Pulled.	Pin 1	Pin 3	> 500K Ohms
	Trigger Pulled	Pin 1	Pin 3	< 1 Ohm
Torch Parts in Place	All Parts In Place.	Pin 3	Pin 9	< 1 Ohm
	All Parts Not In Place.	Pin 3	Pin 9	> 500K Ohms
Pilot Circuit	All Parts In Place.	Pin 5	Pin 6	< 1 Ohm
	All Parts In Place.	Pin 5	Electrode	< 1 Ohm
	All Parts Not In Place.	Pin 5	Electrode	> 500K Ohms

With torch disconnect and all parts in place, perform the tests in table.

# THANK YOU FOR SELECTING A QUALITY PRODUCT BY LINCOLN ELECTRIC.

## PLEASE EXAMINE CARTON AND EQUIPMENT FOR DAMAGE IMMEDIATELY

When this equipment is shipped, title passes to the purchaser upon receipt by the carrier. Consequently, claims for material damaged in shipment must be made by the purchaser against the transportation company at the time the shipment is received.

## SAFETY DEPENDS ON YOU

Lincoln arc welding and cutting equipment is designed and built with safety in mind. However, your overall safety can be increased by proper installation ... and thoughtful operation on your part. **DO NOT INSTALL, OPERATE OR REPAIR THIS EQUIPMENT WITHOUT READING THIS MANUAL AND THE SAFETY PRECAUTIONS CONTAINED THROUGHOUT.** And, most importantly, think before you act and be careful.

### **WARNING**

This statement appears where the information must be followed exactly to avoid serious personal injury or loss of life.

### **CAUTION**

This statement appears where the information must be followed to avoid minor personal injury or damage to this equipment.



## KEEP YOUR HEAD OUT OF THE FUMES.

**DON'T** get too close to the arc. Use corrective lenses if necessary to stay a reasonable distance away from the arc.

**READ** and obey the Safety Data Sheet (SDS) and the warning label that appears on all containers of welding materials.

**USE ENOUGH VENTILATION** or exhaust at the arc, or both, to keep the fumes and gases from your breathing zone and the general area.

**IN A LARGE ROOM OR OUTDOORS**, natural ventilation may be adequate if you keep your head out of the fumes (See below).

**USE NATURAL DRAFTS** or fans to keep the fumes away from your face.

If you develop unusual symptoms, see your supervisor. Perhaps the welding atmosphere and ventilation system should be checked.

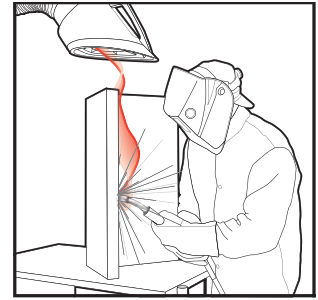

## WEAR CORRECT EYE, EAR & BODY PROTECTION

**PROTECT** your eyes and face with welding helmet properly fitted and with proper grade of filter plate (See ANSI Z49.1).

**PROTECT** your body from welding spatter and arc flash with protective clothing including woolen clothing, flame-proof apron and gloves, leather leggings, and high boots.

**PROTECT** others from splatter, flash, and glare with protective screens or barriers.

**IN SOME AREAS**, protection from noise may be appropriate.

**BE SURE** protective equipment is in good condition.

Also, wear safety glasses in work area **AT ALL TIMES.**



## SPECIAL SITUATIONS

**DO NOT WELD OR CUT** containers or materials which previously had been in contact with hazardous substances unless they are properly cleaned. This is extremely dangerous.

**DO NOT WELD OR CUT** painted or plated parts unless special precautions with ventilation have been taken. They can release highly toxic fumes or gases.

## Additional precautionary measures

**PROTECT** compressed gas cylinders from excessive heat, mechanical shocks, and arcs; fasten cylinders so they cannot fall.

**BE SURE** cylinders are never grounded or part of an electrical circuit.

**REMOVE** all potential fire hazards from welding area.

**ALWAYS HAVE FIRE FIGHTING EQUIPMENT READY FOR IMMEDIATE USE AND KNOW HOW TO USE IT.**



## SECTION A: WARNINGS



### CALIFORNIA PROPOSITION 65 WARNINGS



**WARNING:** Breathing diesel engine exhaust exposes you to chemicals known to the State of California to cause cancer and birth defects, or other reproductive harm.

- Always start and operate the engine in a well-ventilated area.
- If in an exposed area, vent the exhaust to the outside.
- Do not modify or tamper with the exhaust system.
- Do not idle the engine except as necessary.

For more information go to [www.P65warnings.ca.gov/diesel](http://www.P65warnings.ca.gov/diesel)

**WARNING:** This product, when used for welding or cutting, produces fumes or gases which contain chemicals known to the State of California to cause birth defects and, in some cases, cancer. (California Health & Safety Code § 25249.5 *et seq.*)



**WARNING:** Cancer and Reproductive Harm  
[www.P65warnings.ca.gov](http://www.P65warnings.ca.gov)

**ARC WELDING CAN BE HAZARDOUS. PROTECT YOURSELF AND OTHERS FROM POSSIBLE SERIOUS INJURY OR DEATH. KEEP CHILDREN AWAY. PACEMAKER WEARERS SHOULD CONSULT WITH THEIR DOCTOR BEFORE OPERATING.**

Read and understand the following safety highlights. For additional safety information, it is strongly recommended that you purchase a copy of "Safety in Welding & Cutting - ANSI Standard Z49.1" from the American Welding Society, P.O. Box 351040, Miami, Florida 33135 or CSA Standard W117.2. A Free copy of "Arc Welding Safety" booklet E205 is available from the Lincoln Electric Company, 22801 St. Clair Avenue, Cleveland, Ohio 44117-1199.

**BE SURE THAT ALL INSTALLATION, OPERATION, MAINTENANCE AND REPAIR PROCEDURES ARE PERFORMED ONLY BY QUALIFIED INDIVIDUALS.**



### FOR ENGINE POWERED EQUIPMENT.

- Turn the engine off before troubleshooting and maintenance work unless the maintenance work requires it to be running.
- Operate engines in open, well-ventilated areas or vent the engine exhaust fumes outdoors.
- Do not add the fuel near an open flame welding arc or when the engine is running. Stop the engine and allow it to cool before refueling to prevent spilled fuel from vaporizing on contact



with hot engine parts and igniting. Do not spill fuel when filling tank. If fuel is spilled, wipe it up and do not start engine until fumes have been eliminated.

- Keep all equipment safety guards, covers and devices in position and in good repair. Keep hands, hair, clothing and tools away from V-belts, gears, fans and all other moving parts when starting, operating or repairing equipment.
- In some cases it may be necessary to remove safety guards to perform required maintenance. Remove guards only when necessary and replace them when the maintenance requiring their removal is complete. Always use the greatest care when working near moving parts.
- Do not put your hands near the engine fan. Do not attempt to override the governor or idler by pushing on the throttle control rods while the engine is running.
- To prevent accidentally starting gasoline engines while turning the engine or welding generator during maintenance work, disconnect the spark plug wires, distributor cap or magneto wire as appropriate.
- To avoid scalding, do not remove the radiator pressure cap when the engine is hot.
- Using a generator indoors CAN KILL YOU IN MINUTES.
- Generator exhaust contains carbon monoxide. This is a poison you cannot see or smell.
- NEVER use inside a home or garage, EVEN IF doors and windows are open.
- Only use OUTSIDE and far away from windows, doors and vents.
- Avoid other generator hazards. READ MANUAL BEFORE USE.



### ELECTRIC AND MAGNETIC FIELDS MAY BE DANGEROUS



- Electric current flowing through any conductor causes localized Electric and Magnetic Fields (EMF). Welding current creates EMF fields around welding cables and welding machines
- EMF fields may interfere with some pacemakers, and welders having a pacemaker should consult their physician before welding.
- Exposure to EMF fields in welding may have other health effects which are now not known.
- All welders should use the following procedures in order to minimize exposure to EMF fields from the welding circuit:
  - Route the electrode and work cables together - Secure them with tape when possible.
  - Never coil the electrode lead around your body.
  - Do not place your body between the electrode and work cables. If the electrode cable is on your right side, the work cable should also be on your right side.
  - Connect the work cable to the workpiece as close as possible to the area being welded.
  - Do not work next to welding power source.



## ELECTRIC SHOCK CAN KILL.



- 3.a. The electrode and work (or ground) circuits are electrically “hot” when the welder is on. Do not touch these “hot” parts with your bare skin or wet clothing. Wear dry, hole-free gloves to insulate hands.
- 3.b. Insulate yourself from work and ground using dry insulation. Make certain the insulation is large enough to cover your full area of physical contact with work and ground.

**In addition to the normal safety precautions, if welding must be performed under electrically hazardous conditions (in damp locations or while wearing wet clothing; on metal structures such as floors, gratings or scaffolds; when in cramped positions such as sitting, kneeling or lying, if there is a high risk of unavoidable or accidental contact with the workpiece or ground) use the following equipment:**

- Semiautomatic DC Constant Voltage (Wire) Welder.
  - DC Manual (Stick) Welder.
  - AC Welder with Reduced Voltage Control.
- 3.c. In semiautomatic or automatic wire welding, the electrode, electrode reel, welding head, nozzle or semiautomatic welding gun are also electrically “hot”.
  - 3.d. Always be sure the work cable makes a good electrical connection with the metal being welded. The connection should be as close as possible to the area being welded.
  - 3.e. Ground the work or metal to be welded to a good electrical (earth) ground.
  - 3.f. Maintain the electrode holder, work clamp, welding cable and welding machine in good, safe operating condition. Replace damaged insulation.
  - 3.g. Never dip the electrode in water for cooling.
  - 3.h. Never simultaneously touch electrically “hot” parts of electrode holders connected to two welders because voltage between the two can be the total of the open circuit voltage of both welders.
  - 3.i. When working above floor level, use a safety belt to protect yourself from a fall should you get a shock.
  - 3.j. Also see Items 6.c. and 8.



## ARC RAYS CAN BURN.



- 4.a. Use a shield with the proper filter and cover plates to protect your eyes from sparks and the rays of the arc when welding or observing open arc welding. Headshield and filter lens should conform to ANSI Z87.1 standards.
- 4.b. Use suitable clothing made from durable flame-resistant material to protect your skin and that of your helpers from the arc rays.
- 4.c. Protect other nearby personnel with suitable, non-flammable screening and/or warn them not to watch the arc nor expose themselves to the arc rays or to hot spatter or metal.



## FUMES AND GASES CAN BE DANGEROUS.



- 5.a. Welding may produce fumes and gases hazardous to health. Avoid breathing these fumes and gases. When welding, keep your head out of the fume. Use enough ventilation and/or exhaust at the arc to keep fumes and gases away from the breathing zone. **When welding hardfacing (see instructions on container or SDS) or on lead or cadmium plated steel and other metals or coatings which produce highly toxic fumes, keep exposure as low as possible and within applicable OSHA PEL and ACGIH TLV limits using local exhaust or mechanical ventilation unless exposure assessments indicate otherwise. In confined spaces or in some circumstances, outdoors, a respirator may also be required. Additional precautions are also required when welding on galvanized steel.**
- 5.b. The operation of welding fume control equipment is affected by various factors including proper use and positioning of the equipment, maintenance of the equipment and the specific welding procedure and application involved. Worker exposure level should be checked upon installation and periodically thereafter to be certain it is within applicable OSHA PEL and ACGIH TLV limits.
- 5.c. Do not weld in locations near chlorinated hydrocarbon vapors coming from degreasing, cleaning or spraying operations. The heat and rays of the arc can react with solvent vapors to form phosgene, a highly toxic gas, and other irritating products.
- 5.d. Shielding gases used for arc welding can displace air and cause injury or death. Always use enough ventilation, especially in confined areas, to insure breathing air is safe.
- 5.e. Read and understand the manufacturer’s instructions for this equipment and the consumables to be used, including the Safety Data Sheet (SDS) and follow your employer’s safety practices. SDS forms are available from your welding distributor or from the manufacturer.
- 5.f. Also see item 1.b.



## WELDING AND CUTTING SPARKS CAN CAUSE FIRE OR EXPLOSION.



- 6.a. Remove fire hazards from the welding area. If this is not possible, cover them to prevent the welding sparks from starting a fire. Remember that welding sparks and hot materials from welding can easily go through small cracks and openings to adjacent areas. Avoid welding near hydraulic lines. Have a fire extinguisher readily available.
- 6.b. Where compressed gases are to be used at the job site, special precautions should be used to prevent hazardous situations. Refer to "Safety in Welding and Cutting" (ANSI Standard Z49.1) and the operating information for the equipment being used.
- 6.c. When not welding, make certain no part of the electrode circuit is touching the work or ground. Accidental contact can cause overheating and create a fire hazard.
- 6.d. Do not heat, cut or weld tanks, drums or containers until the proper steps have been taken to insure that such procedures will not cause flammable or toxic vapors from substances inside. They can cause an explosion even though they have been "cleaned". For information, purchase "Recommended Safe Practices for the Preparation for Welding and Cutting of Containers and Piping That Have Held Hazardous Substances", AWS F4.1 from the American Welding Society (see address above).
- 6.e. Vent hollow castings or containers before heating, cutting or welding. They may explode.
- 6.f. Sparks and spatter are thrown from the welding arc. Wear oil free protective garments such as leather gloves, heavy shirt, cuffless trousers, high shoes and a cap over your hair. Wear ear plugs when welding out of position or in confined places. Always wear safety glasses with side shields when in a welding area.
- 6.g. Connect the work cable to the work as close to the welding area as practical. Work cables connected to the building framework or other locations away from the welding area increase the possibility of the welding current passing through lifting chains, crane cables or other alternate circuits. This can create fire hazards or overheat lifting chains or cables until they fail.
- 6.h. Also see item 1.c.
- 6.i. Read and follow NFPA 51B "Standard for Fire Prevention During Welding, Cutting and Other Hot Work", available from NFPA, 1 Batterymarch Park, PO box 9101, Quincy, MA 022690-9101.
- 6.j. Do not use a welding power source for pipe thawing.



## CYLINDER MAY EXPLODE IF DAMAGED.



- 7.a. Use only compressed gas cylinders containing the correct shielding gas for the process used and properly operating regulators designed for the gas and pressure used. All hoses, fittings, etc. should be suitable for the application and maintained in good condition.
- 7.b. Always keep cylinders in an upright position securely chained to an undercarriage or fixed support.
- 7.c. Cylinders should be located:
  - Away from areas where they may be struck or subjected to physical damage.
  - A safe distance from arc welding or cutting operations and any other source of heat, sparks, or flame.
- 7.d. Never allow the electrode, electrode holder or any other electrically "hot" parts to touch a cylinder.
- 7.e. Keep your head and face away from the cylinder valve outlet when opening the cylinder valve.
- 7.f. Valve protection caps should always be in place and hand tight except when the cylinder is in use or connected for use.
- 7.g. Read and follow the instructions on compressed gas cylinders, associated equipment, and CGA publication P-1, "Precautions for Safe Handling of Compressed Gases in Cylinders," available from the Compressed Gas Association, 14501 George Carter Way Chantilly, VA 20151.



## FOR ELECTRICALLY POWERED EQUIPMENT.



- 8.a. Turn off input power using the disconnect switch at the fuse box before working on the equipment.
- 8.b. Install equipment in accordance with the U.S. National Electrical Code, all local codes and the manufacturer's recommendations.
- 8.c. Ground the equipment in accordance with the U.S. National Electrical Code and the manufacturer's recommendations.

**Refer to**  
**<http://www.lincolnelectric.com/safety>**  
**for additional safety information.**

<b>WARNING</b>	<ul style="list-style-type: none"> <li>● Do not touch electrically live parts or electrode with skin or wet clothing.</li> <li>● Insulate yourself from work and ground.</li> </ul>	<ul style="list-style-type: none"> <li>● Keep flammable materials away.</li> </ul>	<ul style="list-style-type: none"> <li>● Wear eye, ear and body protection.</li> </ul>
Spanish <b>AVISO DE PRECAUCION</b>	<ul style="list-style-type: none"> <li>● No toque las partes o los electrodos bajo carga con la piel o ropa mojada.</li> <li>● Aíslese del trabajo y de la tierra.</li> </ul>	<ul style="list-style-type: none"> <li>● Mantenga el material combustible fuera del área de trabajo.</li> </ul>	<ul style="list-style-type: none"> <li>● Protéjase los ojos, los oídos y el cuerpo.</li> </ul>
French <b>ATTENTION</b>	<ul style="list-style-type: none"> <li>● Ne laissez ni la peau ni des vêtements mouillés entrer en contact avec des pièces sous tension.</li> <li>● Isolez-vous du travail et de la terre.</li> </ul>	<ul style="list-style-type: none"> <li>● Gardez à l'écart de tout matériel inflammable.</li> </ul>	<ul style="list-style-type: none"> <li>● Protégez vos yeux, vos oreilles et votre corps.</li> </ul>
German <b>WARNUNG</b>	<ul style="list-style-type: none"> <li>● Berühren Sie keine stromführenden Teile oder Elektroden mit Ihrem Körper oder feuchter Kleidung!</li> <li>● Isolieren Sie sich von den Elektroden und dem Erdboden!</li> </ul>	<ul style="list-style-type: none"> <li>● Entfernen Sie brennbares Material!</li> </ul>	<ul style="list-style-type: none"> <li>● Tragen Sie Augen-, Ohren- und Körperschutz!</li> </ul>
Portuguese <b>ATENÇÃO</b>	<ul style="list-style-type: none"> <li>● Não toque partes elétricas e electrodos com a pele ou roupa molhada.</li> <li>● Isole-se da peça e terra.</li> </ul>	<ul style="list-style-type: none"> <li>● Mantenha inflamáveis bem guardados.</li> </ul>	<ul style="list-style-type: none"> <li>● Use proteção para a vista, ouvido e corpo.</li> </ul>
Japanese <b>注意事項</b>	<ul style="list-style-type: none"> <li>● 通電中の電気部品、又は溶材にヒブやぬれた布で触れないこと。</li> <li>● 施工物やアースから身体が絶縁されている様にして下さい。</li> </ul>	<ul style="list-style-type: none"> <li>● 燃えやすいものの側での溶接作業は絶対にしてはなりません。</li> </ul>	<ul style="list-style-type: none"> <li>● 目、耳及び身体に保護具をして下さい。</li> </ul>
Chinese <b>警告</b>	<ul style="list-style-type: none"> <li>● 皮肤或湿衣物切勿接触带电部件及焊缝。</li> <li>● 使你自已與地面和工件絕緣。</li> </ul>	<ul style="list-style-type: none"> <li>● 把一切易燃物品移離工作場所。</li> </ul>	<ul style="list-style-type: none"> <li>● 佩戴眼、耳及身體勞動保護用具。</li> </ul>
Korean <b>위험</b>	<ul style="list-style-type: none"> <li>● 전도체나 용접봉을 젖은 헝겍 또는 피부로 절대 접촉치 마십시오.</li> <li>● 모재와 접지를 접촉치 마십시오.</li> </ul>	<ul style="list-style-type: none"> <li>● 인화성 물질을 접근시키지 마십시오.</li> </ul>	<ul style="list-style-type: none"> <li>● 눈, 귀와 몸에 보호장구를 착용하십시오.</li> </ul>
Arabic <b>تحذير</b>	<ul style="list-style-type: none"> <li>● لا تلمس الاجزاء التي يسري فيها التيار الكهربائي أو الألكترود بجسدك أو بالملابس المبللة بالماء.</li> <li>● ضع عازلا على جسمك خلال العمل.</li> </ul>	<ul style="list-style-type: none"> <li>● ضع المواد القابلة للاشتعال في مكان بعيد.</li> </ul>	<ul style="list-style-type: none"> <li>● ضع أدوات وملابس واقية على عينيك وأذنيك وجسمك.</li> </ul>

READ AND UNDERSTAND THE MANUFACTURER'S INSTRUCTION FOR THIS EQUIPMENT AND THE CONSUMABLES TO BE USED AND FOLLOW YOUR EMPLOYER'S SAFETY PRACTICES.

SE RECOMIENDA LEER Y ENTENDER LAS INSTRUCCIONES DEL FABRICANTE PARA EL USO DE ESTE EQUIPO Y LOS CONSUMIBLES QUE VA A UTILIZAR, SIGA LAS MEDIDAS DE SEGURIDAD DE SU SUPERVISOR.

LISEZ ET COMPRENEZ LES INSTRUCTIONS DU FABRICANT EN CE QUI REGARDE CET EQUIPMENT ET LES PRODUITS A ETRE EMPLOYES ET SUIVEZ LES PROCEDURES DE SECURITE DE VOTRE EMPLOYEUR.

LESEN SIE UND BEFOLGEN SIE DIE BETRIEBSANLEITUNG DER ANLAGE UND DEN ELEKTRODENEINSATZ DES HERSTELLERS. DIE UNFALLVERHÜTUNGSVORSCHRIFTEN DES ARBEITGEBERS SIND EBENFALLS ZU BEACHTEN.

			
<ul style="list-style-type: none"> <li>● Keep your head out of fumes.</li> <li>● Use ventilation or exhaust to remove fumes from breathing zone.</li> </ul>	<ul style="list-style-type: none"> <li>● Turn power off before servicing.</li> </ul>	<ul style="list-style-type: none"> <li>● Do not operate with panel open or guards off.</li> </ul>	<b>WARNING</b>
<ul style="list-style-type: none"> <li>● Los humos fuera de la zona de respiración.</li> <li>● Mantenga la cabeza fuera de los humos. Utilice ventilación o aspiración para gases.</li> </ul>	<ul style="list-style-type: none"> <li>● Desconectar el cable de alimentación de poder de la máquina antes de iniciar cualquier servicio.</li> </ul>	<ul style="list-style-type: none"> <li>● No operar con panel abierto o guardas quitadas.</li> </ul>	Spanish <b>AVISO DE PRECAUCION</b>
<ul style="list-style-type: none"> <li>● Gardez la tête à l'écart des fumées.</li> <li>● Utilisez un ventilateur ou un aspirateur pour ôter les fumées des zones de travail.</li> </ul>	<ul style="list-style-type: none"> <li>● Débranchez le courant avant l'entretien.</li> </ul>	<ul style="list-style-type: none"> <li>● N'opérez pas avec les panneaux ouverts ou avec les dispositifs de protection enlevés.</li> </ul>	French <b>ATTENTION</b>
<ul style="list-style-type: none"> <li>● Vermeiden Sie das Einatmen von Schweißrauch!</li> <li>● Sorgen Sie für gute Be- und Entlüftung des Arbeitsplatzes!</li> </ul>	<ul style="list-style-type: none"> <li>● Strom vor Wartungsarbeiten abschalten! (Netzstrom völlig öffnen; Maschine anhalten!)</li> </ul>	<ul style="list-style-type: none"> <li>● Anlage nie ohne Schutzgehäuse oder Innenschutzverkleidung in Betrieb setzen!</li> </ul>	German <b>WARNUNG</b>
<ul style="list-style-type: none"> <li>● Mantenha seu rosto da fumaça.</li> <li>● Use ventilação e exaustão para remover fumo da zona respiratória.</li> </ul>	<ul style="list-style-type: none"> <li>● Não opere com as tampas removidas.</li> <li>● Desligue a corrente antes de fazer serviço.</li> <li>● Não toque as partes elétricas nuas.</li> </ul>	<ul style="list-style-type: none"> <li>● Mantenha-se afastado das partes moventes.</li> <li>● Não opere com os painéis abertos ou guardas removidas.</li> </ul>	Portuguese <b>ATENÇÃO</b>
<ul style="list-style-type: none"> <li>● ヒュームから頭を離すようにして下さい。</li> <li>● 換気や排煙に十分留意して下さい。</li> </ul>	<ul style="list-style-type: none"> <li>● メンテナンス・サービスに取りかかる際には、まず電源スイッチを必ず切ってください。</li> </ul>	<ul style="list-style-type: none"> <li>● パネルやカバーを取り外したままで機械操作をしないで下さい。</li> </ul>	Japanese <b>注意事項</b>
<ul style="list-style-type: none"> <li>● 頭部遠離煙霧。</li> <li>● 在呼吸區使用通風或排風器除煙。</li> </ul>	<ul style="list-style-type: none"> <li>● 維修前切斷電源。</li> </ul>	<ul style="list-style-type: none"> <li>● 儀表板打開或沒有安全罩時不準作業。</li> </ul>	Chinese <b>警告</b>
<ul style="list-style-type: none"> <li>● 얼굴로부터 용접가스를 멀리하십시오.</li> <li>● 호흡지역으로부터 용접가스를 제거하기 위해 가스제거기나 통풍기를 사용하십시오.</li> </ul>	<ul style="list-style-type: none"> <li>● 보수전에 전원을 차단하십시오.</li> </ul>	<ul style="list-style-type: none"> <li>● 관널이 열린 상태로 작동치 마십시오.</li> </ul>	Korean <b>위험</b>
<ul style="list-style-type: none"> <li>● ابعد رأسك بعيداً عن الدخان.</li> <li>● استعمل التهوية أو جهاز ضغط الدخان للخارج لكي تبعد الدخان عن المنطقة التي تتنفس فيها.</li> </ul>	<ul style="list-style-type: none"> <li>● اقطع التيار الكهربائي قبل القيام بأية صيانة.</li> </ul>	<ul style="list-style-type: none"> <li>● لا تشغيل هذا الجهاز اذا كانت الاعطية الحديدية الواقية ليست عليه.</li> </ul>	Arabic <b>تحذير</b>

**LEIA E COMPREENDA AS INSTRUÇÕES DO FABRICANTE PARA ESTE EQUIPAMENTO E AS PARTES DE USO, E SIGA AS PRÁTICAS DE SEGURANÇA DO EMPREGADOR.**

使う機械や溶材のメーカーの指示書をよく読み、まず理解して下さい。そして貴社の安全規定に従って下さい。

請詳細閱讀並理解製造廠提供的說明以及應該使用的銀焊材料，並請遵守貴方的有關勞動保護規定。

이 제품에 동봉된 작업지침서를 숙지하시고 귀사의 작업자 안전수칙을 준수하시기 바랍니다.

اقرأ بتعمق وافهم تعليمات المصنع المنتج لهذه المعدات والمواد قبل استعمالها واتبع تعليمات الوقاية لصاحب العمل.

## **CUSTOMER ASSISTANCE POLICY**

The business of Lincoln Electric is manufacturing and selling high quality welding equipment, automated welding systems, consumables, and cutting equipment. Our challenge is to meet the needs of our customers, who are experts in their fields, and to exceed their expectations. On occasion, purchasers may ask Lincoln Electric for information or technical information about their use of our products. Our employees respond to inquiries to the best of their ability based on information and specifications provided to them by the customers and the knowledge they may have concerning the application. Our employees, however, are not in a position to verify the information provided or to evaluate the engineering requirements for the particular weldment, or to provide engineering advice in relation to a specific situation or application. Accordingly, Lincoln Electric does not warrant or guarantee or assume any liability with respect to such information or communications. Moreover, the provision of such information or technical information does not create, expand, or alter any warranty on our products. Any express or implied warranty that might arise from the information or technical information, including any implied warranty of merchantability or any warranty of fitness for any customers' particular purpose or any other equivalent or similar warranty is specifically disclaimed.

Lincoln Electric is a responsive manufacturer, but the definition of specifications, and the selection and use of specific products sold by Lincoln Electric is solely within the control of, and remains the sole responsibility of the customer. Many variables beyond the control of Lincoln Electric affect the results obtained in applying these types of fabrication methods and service requirements.

## **WELD FUME CONTROL EQUIPMENT**

The operation of welding fume control equipment is affected by various factors including proper use and positioning of the equipment, maintenance of the equipment and the specific welding procedure and application involved. Worker exposure level should be checked upon installation and periodically thereafter to be certain it is within applicable OSHA PEL and ACGIH TLV limits.



### **THE LINCOLN ELECTRIC COMPANY**

22801 St. Clair Avenue • Cleveland, OH • 44117-1199 • U.S.A.  
Phone: +1.216.481.8100 • [www.lincolnelectric.com](http://www.lincolnelectric.com)