

Operator's Manual

APEX[®] 3 SERIES TIG PENDANT

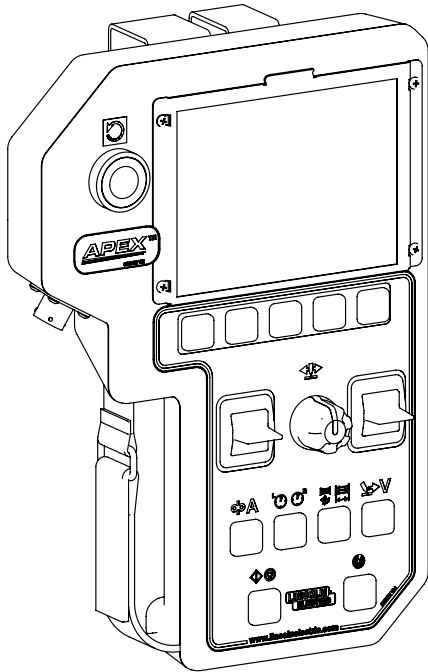

For use with machines having Code Numbers:
12834



Register your machine:
www.lincolnelectric.com/register
Authorized Service and Distributor Locator:
www.lincolnelectric.com/locator

Save for future reference

Date Purchased

Code: (ex: 10859)

Serial: (ex: U1060512345)

Need Help? Call 1.888.935.3877
to talk to a Service Representative

Hours of Operation:
8:00 AM to 6:00 PM (ET) Mon. thru Fri.

After hours?
Use "Ask the Experts" at lincolnelectric.com
A Lincoln Service Representative will contact you
no later than the following business day.

For Service outside the USA:
Email: globalservice@lincolnelectric.com

THE LINCOLN ELECTRIC COMPANY
22801 St. Clair Avenue • Cleveland, OH • 44117-1199 • U.S.A.
Phone: +1.216.481.8100 • www.lincolnelectric.com

LINCOLN ELECTRIC EUROPE S.L.
c/o Balmes, 89 - 8^o 2^a
08008 Barcelona
SPAIN

THANK YOU FOR SELECTING A QUALITY PRODUCT BY LINCOLN ELECTRIC.

PLEASE EXAMINE CARTON AND EQUIPMENT FOR DAMAGE IMMEDIATELY

When this equipment is shipped, title passes to the purchaser upon receipt by the carrier. Consequently, claims for material damaged in shipment must be made by the purchaser against the transportation company at the time the shipment is received.

SAFETY DEPENDS ON YOU

Lincoln arc welding and cutting equipment is designed and built with safety in mind. However, your overall safety can be increased by proper installation ... and thoughtful operation on your part. **DO NOT INSTALL, OPERATE OR REPAIR THIS EQUIPMENT WITHOUT READING THIS MANUAL AND THE SAFETY PRECAUTIONS CONTAINED THROUGHOUT.** And, most importantly, think before you act and be careful.

WARNING

This statement appears where the information must be followed exactly to avoid serious personal injury or loss of life.

CAUTION

This statement appears where the information must be followed to avoid minor personal injury or damage to this equipment.



KEEP YOUR HEAD OUT OF THE FUMES.

DON'T get too close to the arc. Use corrective lenses if necessary to stay a reasonable distance away from the arc.

READ and obey the Safety Data Sheet (SDS) and the warning label that appears on all containers of welding materials.

USE ENOUGH VENTILATION or exhaust at the arc, or both, to keep the fumes and gases from your breathing zone and the general area.

IN A LARGE ROOM OR OUTDOORS, natural ventilation may be adequate if you keep your head out of the fumes (See below).

USE NATURAL DRAFTS or fans to keep the fumes away from your face.

If you develop unusual symptoms, see your supervisor. Perhaps the welding atmosphere and ventilation system should be checked.

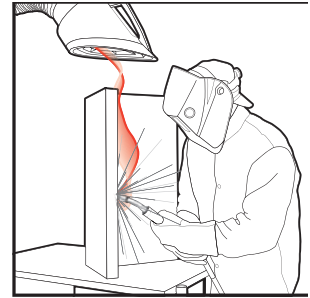

WEAR CORRECT EYE, EAR & BODY PROTECTION

PROTECT your eyes and face with welding helmet properly fitted and with proper grade of filter plate (See ANSI Z49.1).

PROTECT your body from welding spatter and arc flash with protective clothing including woolen clothing, flame-proof apron and gloves, leather leggings, and high boots.

PROTECT others from splatter, flash, and glare with protective screens or barriers.

IN SOME AREAS, protection from noise may be appropriate.

BE SURE protective equipment is in good condition.

Also, wear safety glasses in work area **AT ALL TIMES.**



SPECIAL SITUATIONS

DO NOT WELD OR CUT containers or materials which previously had been in contact with hazardous substances unless they are properly cleaned. This is extremely dangerous.

DO NOT WELD OR CUT painted or plated parts unless special precautions with ventilation have been taken. They can release highly toxic fumes or gases.

Additional precautionary measures

PROTECT compressed gas cylinders from excessive heat, mechanical shocks, and arcs; fasten cylinders so they cannot fall.

BE SURE cylinders are never grounded or part of an electrical circuit.

REMOVE all potential fire hazards from welding area.

ALWAYS HAVE FIRE FIGHTING EQUIPMENT READY FOR IMMEDIATE USE AND KNOW HOW TO USE IT.



SECTION A: WARNINGS



CALIFORNIA PROPOSITION 65 WARNINGS



WARNING: Breathing diesel engine exhaust exposes you to chemicals known to the State of California to cause cancer and birth defects, or other reproductive harm.

- Always start and operate the engine in a well-ventilated area.
- If in an exposed area, vent the exhaust to the outside.
- Do not modify or tamper with the exhaust system.
- Do not idle the engine except as necessary.

For more information go to www.P65warnings.ca.gov/diesel

WARNING: This product, when used for welding or cutting, produces fumes or gases which contain chemicals known to the State of California to cause birth defects and, in some cases, cancer. (California Health & Safety Code § 25249.5 *et seq.*)



WARNING: Cancer and Reproductive Harm
www.P65warnings.ca.gov

ARC WELDING CAN BE HAZARDOUS. PROTECT YOURSELF AND OTHERS FROM POSSIBLE SERIOUS INJURY OR DEATH. KEEP CHILDREN AWAY. PACEMAKER WEARERS SHOULD CONSULT WITH THEIR DOCTOR BEFORE OPERATING.

Read and understand the following safety highlights. For additional safety information, it is strongly recommended that you purchase a copy of "Safety in Welding & Cutting - ANSI Standard Z49.1" from the American Welding Society, P.O. Box 351040, Miami, Florida 33135 or CSA Standard W117.2-1974. A Free copy of "Arc Welding Safety" booklet E205 is available from the Lincoln Electric Company, 22801 St. Clair Avenue, Cleveland, Ohio 44117-1199.

BE SURE THAT ALL INSTALLATION, OPERATION, MAINTENANCE AND REPAIR PROCEDURES ARE PERFORMED ONLY BY QUALIFIED INDIVIDUALS.



FOR ENGINE POWERED EQUIPMENT.

- Turn the engine off before troubleshooting and maintenance work unless the maintenance work requires it to be running.
- Operate engines in open, well-ventilated areas or vent the engine exhaust fumes outdoors.
- Do not add the fuel near an open flame welding arc or when the engine is running. Stop the engine and allow it to cool before refueling to prevent spilled fuel from vaporizing on contact



with hot engine parts and igniting. Do not spill fuel when filling tank. If fuel is spilled, wipe it up and do not start engine until fumes have been eliminated.

- Keep all equipment safety guards, covers and devices in position and in good repair. Keep hands, hair, clothing and tools away from V-belts, gears, fans and all other moving parts when starting, operating or repairing equipment.
- In some cases it may be necessary to remove safety guards to perform required maintenance. Remove guards only when necessary and replace them when the maintenance requiring their removal is complete. Always use the greatest care when working near moving parts.
- Do not put your hands near the engine fan. Do not attempt to override the governor or idler by pushing on the throttle control rods while the engine is running.
- To prevent accidentally starting gasoline engines while turning the engine or welding generator during maintenance work, disconnect the spark plug wires, distributor cap or magneto wire as appropriate.
- To avoid scalding, do not remove the radiator pressure cap when the engine is hot.



ELECTRIC AND MAGNETIC FIELDS MAY BE DANGEROUS



- Electric current flowing through any conductor causes localized Electric and Magnetic Fields (EMF). Welding current creates EMF fields around welding cables and welding machines
- EMF fields may interfere with some pacemakers, and welders having a pacemaker should consult their physician before welding.
- Exposure to EMF fields in welding may have other health effects which are now not known.
- All welders should use the following procedures in order to minimize exposure to EMF fields from the welding circuit:
 - Route the electrode and work cables together - Secure them with tape when possible.
 - Never coil the electrode lead around your body.
 - Do not place your body between the electrode and work cables. If the electrode cable is on your right side, the work cable should also be on your right side.
 - Connect the work cable to the workpiece as close as possible to the area being welded.
 - Do not work next to welding power source.



ELECTRIC SHOCK CAN KILL.



- 3.a. The electrode and work (or ground) circuits are electrically “hot” when the welder is on. Do not touch these “hot” parts with your bare skin or wet clothing. Wear dry, hole-free gloves to insulate hands.
- 3.b. Insulate yourself from work and ground using dry insulation. Make certain the insulation is large enough to cover your full area of physical contact with work and ground.

In addition to the normal safety precautions, if welding must be performed under electrically hazardous conditions (in damp locations or while wearing wet clothing; on metal structures such as floors, gratings or scaffolds; when in cramped positions such as sitting, kneeling or lying, if there is a high risk of unavoidable or accidental contact with the workpiece or ground) use the following equipment:

- Semiautomatic DC Constant Voltage (Wire) Welder.
 - DC Manual (Stick) Welder.
 - AC Welder with Reduced Voltage Control.
- 3.c. In semiautomatic or automatic wire welding, the electrode, electrode reel, welding head, nozzle or semiautomatic welding gun are also electrically “hot”.
 - 3.d. Always be sure the work cable makes a good electrical connection with the metal being welded. The connection should be as close as possible to the area being welded.
 - 3.e. Ground the work or metal to be welded to a good electrical (earth) ground.
 - 3.f. Maintain the electrode holder, work clamp, welding cable and welding machine in good, safe operating condition. Replace damaged insulation.
 - 3.g. Never dip the electrode in water for cooling.
 - 3.h. Never simultaneously touch electrically “hot” parts of electrode holders connected to two welders because voltage between the two can be the total of the open circuit voltage of both welders.
 - 3.i. When working above floor level, use a safety belt to protect yourself from a fall should you get a shock.
 - 3.j. Also see Items 6.c. and 8.



ARC RAYS CAN BURN.



- 4.a. Use a shield with the proper filter and cover plates to protect your eyes from sparks and the rays of the arc when welding or observing open arc welding. Headshield and filter lens should conform to ANSI Z87.1 standards.
- 4.b. Use suitable clothing made from durable flame-resistant material to protect your skin and that of your helpers from the arc rays.
- 4.c. Protect other nearby personnel with suitable, non-flammable screening and/or warn them not to watch the arc nor expose themselves to the arc rays or to hot spatter or metal.



FUMES AND GASES CAN BE DANGEROUS.



- 5.a. Welding may produce fumes and gases hazardous to health. Avoid breathing these fumes and gases. When welding, keep your head out of the fume. Use enough ventilation and/or exhaust at the arc to keep fumes and gases away from the breathing zone. **When welding hardfacing (see instructions on container or SDS) or on lead or cadmium plated steel and other metals or coatings which produce highly toxic fumes, keep exposure as low as possible and within applicable OSHA PEL and ACGIH TLV limits using local exhaust or mechanical ventilation unless exposure assessments indicate otherwise. In confined spaces or in some circumstances, outdoors, a respirator may also be required. Additional precautions are also required when welding on galvanized steel.**
- 5.b. The operation of welding fume control equipment is affected by various factors including proper use and positioning of the equipment, maintenance of the equipment and the specific welding procedure and application involved. Worker exposure level should be checked upon installation and periodically thereafter to be certain it is within applicable OSHA PEL and ACGIH TLV limits.
- 5.c. Do not weld in locations near chlorinated hydrocarbon vapors coming from degreasing, cleaning or spraying operations. The heat and rays of the arc can react with solvent vapors to form phosgene, a highly toxic gas, and other irritating products.
- 5.d. Shielding gases used for arc welding can displace air and cause injury or death. Always use enough ventilation, especially in confined areas, to insure breathing air is safe.
- 5.e. Read and understand the manufacturer’s instructions for this equipment and the consumables to be used, including the Safety Data Sheet (SDS) and follow your employer’s safety practices. SDS forms are available from your welding distributor or from the manufacturer.
- 5.f. Also see item 1.b.

**WELDING AND CUTTING SPARKS CAN CAUSE FIRE OR EXPLOSION.**

- 6.a. Remove fire hazards from the welding area. If this is not possible, cover them to prevent the welding sparks from starting a fire. Remember that welding sparks and hot materials from welding can easily go through small cracks and openings to adjacent areas. Avoid welding near hydraulic lines. Have a fire extinguisher readily available.
- 6.b. Where compressed gases are to be used at the job site, special precautions should be used to prevent hazardous situations. Refer to "Safety in Welding and Cutting" (ANSI Standard Z49.1) and the operating information for the equipment being used.
- 6.c. When not welding, make certain no part of the electrode circuit is touching the work or ground. Accidental contact can cause overheating and create a fire hazard.
- 6.d. Do not heat, cut or weld tanks, drums or containers until the proper steps have been taken to insure that such procedures will not cause flammable or toxic vapors from substances inside. They can cause an explosion even though they have been "cleaned". For information, purchase "Recommended Safe Practices for the Preparation for Welding and Cutting of Containers and Piping That Have Held Hazardous Substances", AWS F4.1 from the American Welding Society (see address above).
- 6.e. Vent hollow castings or containers before heating, cutting or welding. They may explode.
- 6.f. Sparks and spatter are thrown from the welding arc. Wear oil free protective garments such as leather gloves, heavy shirt, cuffless trousers, high shoes and a cap over your hair. Wear ear plugs when welding out of position or in confined places. Always wear safety glasses with side shields when in a welding area.
- 6.g. Connect the work cable to the work as close to the welding area as practical. Work cables connected to the building framework or other locations away from the welding area increase the possibility of the welding current passing through lifting chains, crane cables or other alternate circuits. This can create fire hazards or overheat lifting chains or cables until they fail.
- 6.h. Also see item 1.c.
- 6.i. Read and follow NFPA 51B "Standard for Fire Prevention During Welding, Cutting and Other Hot Work", available from NFPA, 1 Batterymarch Park, PO box 9101, Quincy, MA 022690-9101.
- 6.j. Do not use a welding power source for pipe thawing.

**CYLINDER MAY EXPLODE IF DAMAGED.**

- 7.a. Use only compressed gas cylinders containing the correct shielding gas for the process used and properly operating regulators designed for the gas and pressure used. All hoses, fittings, etc. should be suitable for the application and maintained in good condition. 
- 7.b. Always keep cylinders in an upright position securely chained to an undercarriage or fixed support.
- 7.c. Cylinders should be located:
 - Away from areas where they may be struck or subjected to physical damage.
 - A safe distance from arc welding or cutting operations and any other source of heat, sparks, or flame.
- 7.d. Never allow the electrode, electrode holder or any other electrically "hot" parts to touch a cylinder.
- 7.e. Keep your head and face away from the cylinder valve outlet when opening the cylinder valve.
- 7.f. Valve protection caps should always be in place and hand tight except when the cylinder is in use or connected for use.
- 7.g. Read and follow the instructions on compressed gas cylinders, associated equipment, and CGA publication P-1, "Precautions for Safe Handling of Compressed Gases in Cylinders," available from the Compressed Gas Association, 14501 George Carter Way Chantilly, VA 20151.

**FOR ELECTRICALLY POWERED EQUIPMENT.**

- 8.a. Turn off input power using the disconnect switch at the fuse box before working on the equipment.
- 8.b. Install equipment in accordance with the U.S. National Electrical Code, all local codes and the manufacturer's recommendations.
- 8.c. Ground the equipment in accordance with the U.S. National Electrical Code and the manufacturer's recommendations.

Refer to
<http://www.lincolnelectric.com/safety>
for additional safety information.

ELECTROMAGNETIC COMPATIBILITY (EMC)

CONFORMANCE

Products displaying the CE mark are in conformity with European Community Council Directive of 3 May 1989 on the approximation of the laws of the Member States relating to electromagnetic compatibility (89/336/EEC). It was manufactured in conformity with a national standard that implements a harmonized standard: EN 60974-10

Electromagnetic Compatibility (EMC) Product Standard for Arc Welding Equipment. It is for use with other Lincoln Electric equipment. It is designed for industrial and professional use.

INTRODUCTION

All electrical equipment generates small amounts of electromagnetic emission. Electrical emission may be transmitted through power lines or radiated through space, similar to a radio transmitter. When emissions are received by other equipment, electrical interference may result. Electrical emissions may affect many kinds of electrical equipment; other nearby welding equipment, radio and TV reception, numerical controlled machines, telephone systems, computers, etc. Be aware that interference may result and extra precautions may be required when a welding power source is used in a domestic establishment.

INSTALLATION AND USE

The user is responsible for installing and using the welding equipment according to the manufacturer's instructions. If electromagnetic disturbances are detected then it shall be the responsibility of the user of the welding equipment to resolve the situation with the technical assistance of the manufacturer. In some cases this remedial action may be as simple as earthing (grounding) the welding circuit, see Note. In other cases it could involve construction of an electromagnetic screen enclosing the power source and the work complete with associated input filters. In all cases electromagnetic disturbances must be reduced to the point where they are no longer troublesome.

Note: The welding circuit may or may not be earthed for safety reasons according to national codes. Changing the earthing arrangements should only be authorized by a person who is competent to assess whether the changes will increase the risk of injury, e.g., by allowing parallel welding current return paths which may damage the earth circuits of other equipment.

ASSESSMENT OF AREA

Before installing welding equipment the user shall make an assessment of potential electromagnetic problems in the surrounding area. The following shall be taken into account:

- a. other supply cables, control cables, signaling and telephone cables; above, below and adjacent to the welding equipment;
- b. radio and television transmitters and receivers;
- c. computer and other control equipment;
- d. safety critical equipment, e.g., guarding of industrial equipment;
- e. the health of the people around, e.g., the use of pacemakers and hearing aids;
- f. equipment used for calibration or measurement
- g. the immunity of other equipment in the environment. The user shall ensure that other equipment being used in the environment is compatible. This may require additional protection measures;
- h. the time of day that welding or other activities are to be carried out.

The size of the surrounding area to be considered will depend on the structure of the building and other activities that are taking place. The surrounding area may extend beyond the boundaries of the premises.

METHODS OF REDUCING EMISSIONS

Mains Supply

Welding equipment should be connected to the mains supply according to the manufacturer's recommendations. If interference occurs, it may be necessary to take additional precautions such as filtering of the mains supply. Consideration should be given to shielding the supply cable of permanently installed welding equipment, in metallic conduit or equivalent. Shielding should be electrically continuous throughout its length. The shielding should be connected to the welding power source so that good electrical contact is maintained between the conduit and the welding power source enclosure.

Maintenance of the Welding Equipment

The welding equipment should be routinely maintained according to the manufacturer's recommendations. All access and service doors and covers should be closed and properly fastened when the welding equipment is in operation. The welding equipment should not be modified in any way except for those changes and adjustments covered in the manufacturer's instructions. In particular, the spark gaps of arc striking and stabilizing devices should be adjusted and maintained according to the manufacturer's recommendations.

Welding Cables

The welding cables should be kept as short as possible and should be positioned close together, running at or close to floor level.

Equipotential Bonding

Bonding of all metallic components in the welding installation and adjacent to it should be considered. However, metallic components bonded to the work piece will increase the risk that the operator could receive a shock by touching these metallic components and the electrode at the same time. The operator should be insulated from all such bonded metallic components.

Earthing of the Workpiece

Where the workpiece is not bonded to earth for electrical safety, not connected to earth because of its size and position, e.g., ships hull or building steelwork, a connection bonding the workpiece to earth may reduce emissions in some, but not all instances. Care should be taken to prevent the earthing of the work piece increasing the risk of injury to users, or damage to other electrical equipment. Where necessary, the connection of the workpiece to earth should be made by a direct connection to the work piece, but in some countries where direct connection is not permitted, the bonding should be achieved by suitable capacitance, selected according to national regulations.

Screening and Shielding

Selective screening and shielding of other cables and equipment in the surrounding area may alleviate problems of interference. Screening of the entire welding installation may be considered for special applications.

1 Portions of the preceding text are contained in EN 60974-10: "Electromagnetic Compatibility (EMC) product standard for arc welding equipment."

WEEE





































































<p>English</p> 	<p style="text-align: right;">07/06</p> <p>Do not dispose of electrical equipment together with normal waste! In observance of European Directive 2002/96/EC on Waste Electrical and Electronic Equipment (WEEE) and its implementation in accordance with national law, electrical equipment that has reached the end of its life must be collected separately and returned to an environmentally compatible recycling facility. As the owner of the equipment, you should get information on approved collection systems from our local representative. By applying this European Directive you will protect the environment and human health!</p>
--	--

Safety	2
Symbols & Icons	A-10
Safety Precautions	A-11
Proper Handling	A-11
Operation	A-11
Explanation of Welding Terms.....	A-11
System Start Up	A-12
Startup Screen	A-12
Pendant Operation	A-13
Button Actions	A-13
Selection Buttons.....	A-13
Navigation Controls	A-13
Menu Buttons	A-14
Control Buttons.....	A-14
Color Coding.....	A-14
Fast Movement	A-14
System Log In	A-15
Fast Movement	A-15
Login	A-15
Log In Screen.....	A-16
Idle Screen	A-17
Menu Option Variables.....	A-17
Idle Screen Buttons.....	A-19
Idle Screen Test/Weld Modes.....	A-20
Static Screen Items.....	A-21
Test Screen	A-21
Test Screen Buttons.....	A-21
Weld Screen.....	A-22
Weld Screen Buttons	A-22
Jog Screen	A-22
Jog Buttons.....	A-23
Oscillation Screen	A-24
Oscillation Buttons.....	A-25
Setup Screen.....	A-26
Setup Screen Options.....	A-26
Track Setup.....	A-27
Track Type	A-27
Track Ring Size	A-27
Pipe Size	A-27
Heavy Wall Pipes	A-27
Travel Setup Screen.....	A-28
Process Setup Screen	A-29
Standard Process Options.....	A-29
Weave Process Options.....	A-30
Mode Select	A-31
Advanced Process Setup	A-31
Advanced Options	A-31
Wave Controls.....	A-31
Sensitivity Recommendations.....	A-32
Sync Mode Screen.....	A-33
Sector Setup Screen.....	A-34
Start Settings	A-36
AVC Start.....	A-37
End Settings.....	A-37
Service Menu	A-38
Version	A-38
Motion.....	A-38
Faults	A-39
Settings.....	A-40
How To Take A Snapshot.....	A-40
Users	A-41
Fast Movement	A-41
Adding Users	A-41

Deleting Users.....	A-42
Changing User Access	A-42
Log Out	A-43
Operator Log In.....	A-43
Increments Settings	A-43
Increment Reference.....	A-44
Programs	A-45
Fast Movement	A-45
Saving an Independent Pass	A-45
Saving a Program Base	A-46
Saving a Program Pass.....	A-46
Saving Program Updates.....	A-47
Hide Program Passes	A-48
Saving to a USB.....	A-48
Copy to/from USB	A-48
Deleting a Program	A-49
Deleting a Program Base	A-49
Loading a Program	A-49
Overwriting a Program	A-50
Operator Navigation Chart.....	A-51
Diagrams	G-52
Standard Piping Schedule Chart.....	G-54
Parts Manual.....	G-55

Symbols & Icons

This list is a quick reference for all icons from the pendant and on the control unit.

	Users		Set Up/ Modes		Wire		Reboot		Insert
	Weld		Weld Time		Upslope / Start Settings		Process		Track Ring
	Test Mode		Reset Settings		Downslope / End Settings		Version		Track Ring Diameter
	Sector		Enter		Time		Motion		Pipe
	Trash/Delete		Voltage		Program		Return Home		Pipe Diameter
	Gas Purge Pre/Post Flow		Amperage		Volts		Trim		Log Out
	Save		Travel / Travel Setup		Speed		Left Dwell		Settings / Service Page
	Swap		Shift Case		Width		Right Dwell		Increment Unit Settings
	Gas		Advanced Settings		Next / Index		Travel Direction		Positioner
	ID Track		Water		Wire Feed Forward		Travel Direction		Wire / Wire Feed Speed
	OD Track		Steering / Oscillator		Wire Speed Reverse		Travel Direction		Previous / Index
	Flat Track		Wire Diam- eter		Pass		Travel Direction		Add User
	Direction		Delay		Volts Peak		Details		Weave Type
	Manual Height		Torch/Auto Height		Oscillation Speed		Copy To		Constant Travel
	Exit		Oscillation		1, 2, 3... Mode Select		Cancel		Step Travel
	Oscillation Width		Weld Mode		Load		Okay		No Weave Travel
	Snapshot		Weld Head		Wire On		Faults		Settings

Safety Precautions

Read entire manual before installation or operation.



WARNING



ELECTRIC SHOCK CAN KILL

- Only qualified personnel should perform this installation.
- Turn the input power OFF at the disconnect switch or fuse box before working on this equipment turn off the input power to any other

equipment connected to the welding system at the disconnect switch or fuse box before working on the equipment.

- Do not touch electrically hot parts.
- Always connect the power supply grounding lug to a proper safety (Earth) ground.

Proper handling

The APEX® 3 Series TIG Pendant is designed to be turned on and off through the power supply. The pendant should be kept dry and sheltered from rain and snow. Do not place or drop the pendant on wet ground or in puddles. Always place the pendant on a sturdy, flat level surface when not in use and be sure to unplug it.

Operation

Read this entire process and operations manual before using the pendant.

Keep hands away from weld head, wire feeder and other moving parts while in operation.



CAUTION

Never unplug or plug in control cables to the tractor while the system is powered on.

Verify that the system is properly grounded before beginning to weld.

Refer to the individual system manuals for additional instructions.

Explanation of Welding Terms

GTAW: Gas Tungsten Arc Welding

WFS: Wire Feed Speed

OSC: Oscillation

AVC: Automatic Voltage Control

ID: Inside Diameter

OD: Outside Diameter

WFS: Wire Feed Speed

IPM: Inches per minute

CM/MIN: Centimeters per minute

Volts: Voltage

Amps: Amperage

System Start Up

Ensure all components are connected. Refer to the individual component manuals for full connection instructions.



FIGURE 1 - Startup Screen

Prior to beginning the weld, turn on the welding power supply. The system is designed to be turned on and off through the welding power supply.

Startup Screen

When the system is reset at the Power Wave®, the screen will display “Checking Network Connection... Calibrating System – FIGURE 1 - Startup Screen. This is a normal part of the initialization process.

Note: During the start up interval, the weld head goes through a self-calibration cycle. The system will not allow the user to log in until the calibration cycle has been completed.

When the system is fully calibrated, the user is presented with a log in screen – see FIGURE 2 - Log In Screen. Log in to begin use. See the next sections for pendant operation.



FIGURE 2 - Log In Screen

Pendant Operation

The APEX 3 Series Pendant is designed around full functionality and easy operator experience. The pendant's buttons serve multiple purposes, depending on the screen display. See **FIGURE 3 - Pendant Items** for all buttons, knobs and switches.

Button Actions

Each of the buttons and toggles may perform differently depending on how the buttons are pressed. Listed below are the four types of button presses.

1. **SHORT PRESS** - A short press is a standard press that engages the button and is not held in place. Most operations are performed as a short press.

Example: Quickly pressing down button 7 will center the oscillator.

2. **LONG PRESS** - For some screens, holding a button down for a length of time exceeding two seconds signals the system to perform an alternate function.

Example: A long press of more than two seconds of button 7 will start the oscillation test mode on some screens.

3. **HOLD** - By pressing and holding down a button or toggle, the effects exhibited will continue or speed up.

Example: When pressing button 1 in the jog screen, gas will purge for 3 seconds. Holding down button 1 will cause the gas to continuously purge.

4. **HOLD AND ROTATE** - The steering knob also acts as a button. It can be pressed or rotated for different actions for some screens. It can be held down and rotated for faster navigation.

Selection Buttons

Buttons 1 through 5 are selection buttons, their functions change depending on the screen. In each screen there will be an icon to indicate functions.



FIGURE 3 - Pendant Items

Navigation Controls

Items 6 through 8 control navigation. They function primarily for navigating through the menus and changing values while setting up the system.

Note: When welding, steering knob 7 functions only for steering or oscillation steering if oscillation is enabled.

6. LEFT TOGGLE (WHITE BORDER) -

- **Short Press** - navigates or changes the selected value (in this example, it will change the value in the left dwell box).
- **Hold** - Increases or decreases value/change speed on some screens.

7. STEERING KNOB -

- **Rotate** - Steers the oscillation in and out, or changes the selected variable
- **Short Press** - Centers the oscillation, or moves to the next variable

- **Long Press** - Starts/stops oscillation test (in idle mode only)
- **Hold and Rotate** - Fast navigation between selected variables

8. RIGHT TOGGLE (GRAY BORDER) -

- **Short Press** - Navigates or changes the selected value (in this example it will change the value in the right dwell box)
- **Hold** - Increases value / change speed

Menu Buttons

Buttons 9 through 12 are the menu buttons. Pressing these buttons bring up a menu screen while in the idle, test or welding screens.

9. WIRE FEED/AMPS -

- **Short Press** - Wire Feed/Amps options
- **Long Press** - Navigates to the Jog Screen from the Idle Weld screen

10. DWELL -

- **Short Press** - Dwell options
- **Long Press** - Navigates to the Oscillation Screen from the Idle Weld screen

11. OSCILLATION -

- **Short Press** - Oscillation options
- **Long Press** - Navigates to the Oscillation Screen from the Idle Weld screen

12. TRAVEL/VOLTS -

- **Short Press** - Travel/Voltage options
- **Long Press** - Navigates to the Jog Screen from the Idle Weld Screen

Control Buttons

Buttons 13 through 15 are the control buttons. These buttons have a specific purpose that typically will not change. **Note: Buttons may be disabled in menu screens**

13. START/STOP -

- **Short Press** - Start if idle, stop if welding, stop/start test weld when in test mode

14. SECTOR -

- **Short Press** - Switches between sectors if available; switches between passes (if available) on the Increments screen; turns Auto-Sector feature ON/OFF on the Sectors Screen

15. RESET

- **Short Press** - Initiates a system reset

IMPORTANT! The reset button is not an emergency stop button. Power is still being applied to the system.

Color Coding

The menu buttons and toggles are color-coded. For example, the icons above button 9 are Wire Feed (white icon) and Amps (gray icon). When the operator presses the 9 button in the weld (idle) screen, the value for the Wire Feed (white icon) will be presented and can be changed by the left toggle (white border) and the value for Amps (gray icon) will be presented and can be changed by the right toggle (gray border).

Fast Movement

Certain screens allow for fast movement using the steering knob. Movement and selection can still be accomplished with the left and right toggle. In addition the steering knob will allow the user to change the selection by turning the knob and moving to the next section by pressing the knob.

For fast movement between selections hold the steering knob down while turning to rapidly move from one selection to the other.

System Log In

When powered on, the system will go through a self-calibration routine. Make sure the torch is free to move before starting the system.

When the calibration routine is complete, the user will be presented with a Log In Screen – see **FIGURE 7 - Log In Screen Buttons**.

Fast Movement

Fast movement using the steering knob is enabled on this screen. See **FIGURES 4, 4A and 4B - Fast Movement**. Use the steering knob or left and right toggles for navigation and selection.

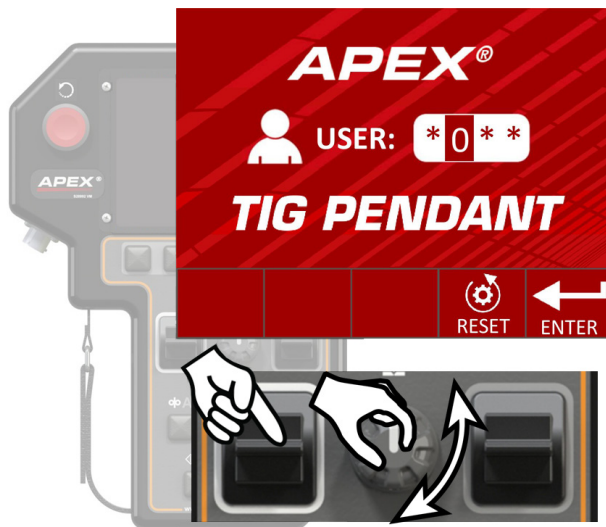

FIGURE 4 - Fast Movement Steering Knob



FIGURE 4A - Fast Movement Left Toggle

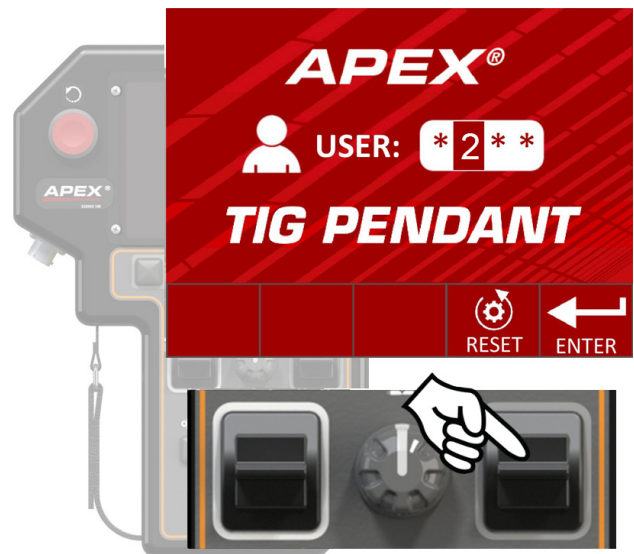

FIGURE 4B - Fast Movement Right Toggle

Login

The system requires a four digit log code in to log in. Use the left toggle to change from one variable to the next. Use the right toggle to change the selected variable.

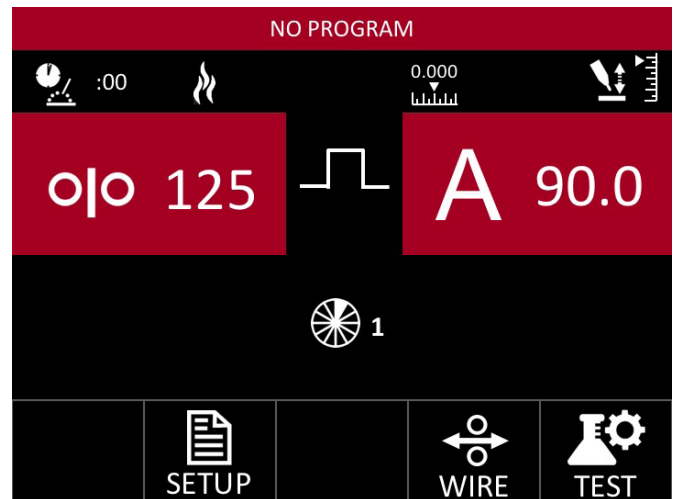

FIGURE 5 - Idle Screen Default

Press the Enter selection button when user code has been entered. Once a four-digit code is accepted the system automatically moves into the default Idle screen see **FIGURE 5 - Idle Screen Default**. This screen is shown when a supervisor logs into the system.

From the Idle screen is possible to move into the Setup screen, Jog and Oscillation screens as well as switch between test and weld modes.

Note: The values shown on each screen are representative only.

Log In Screen

The following buttons and options are available from the log in screen:

1. N/A

- No Effect

2. N/A

- No Effect

3. N/A

- No Effect

4. RESET -

- **Short Press** - Will change password entry back to "0000"

5. ENTER -

- **Short Press** - Attempts to log in to the system with the currently entered user code

6. LEFT TOGGLE (White Border) -

- **Short Press** - Pressing up or down moves cursor between spaces

7. STEERING KNOB - Fast Movement

8. RIGHT TOGGLE (Gray Border) -

- **Short Press** - Pressing up or down changes value of the selection

9. WIRE FEED/AMPS -

- No Effect

10. DWELL -

- No Effect

11. OSCILLATION -

- No Effect

12. TRAVEL/VOLTS -

- No Effect

13. START/STOP -

- No Effect

14. SECTOR -

- No Effect

15. RESET

- **Short Press** - Initiates a system reset

IMPORTANT! The reset button is not an emergency stop button. Power is still being applied to the system.



FIGURE 6 - Log In Screen

Idle Screen

The Idle Screen is the first screen presented to a supervisor when logging in – see **FIGURE 5 - Idle Screen Default on page A-15**. This screen allows the supervisor to set up all parameters for welding, test the parameters if necessary and to start welding.

Menu Option Variables

The Idle Screen allows the user access to up to thirteen separate variables, depending on which menu button has been pressed and which are enabled.

The following weld variables are available to be viewed and changed on the Idle Screen:

- ▶ Wire Feed Speed – Peak value
- ▶ Wire Feed Speed – Background value
- ▶ Amps – Peak value
- ▶ Amps – Background value
- ▶ Hot Wire Amps – Peak value
- ▶ Hot Wire Amps – Background value
- ▶ Dwell Left value
- ▶ Dwell Right value
- ▶ Oscillation Speed value
- ▶ Oscillation Width value
- ▶ Travel Speed value
- ▶ Voltage – Peak value
- ▶ Voltage – Background value

Pressing the different menu buttons will change the displayed values which correspond to the icons on the menu buttons.

Pressing the Menu button opens the Wire Feed Speed/ Amps Menu options.

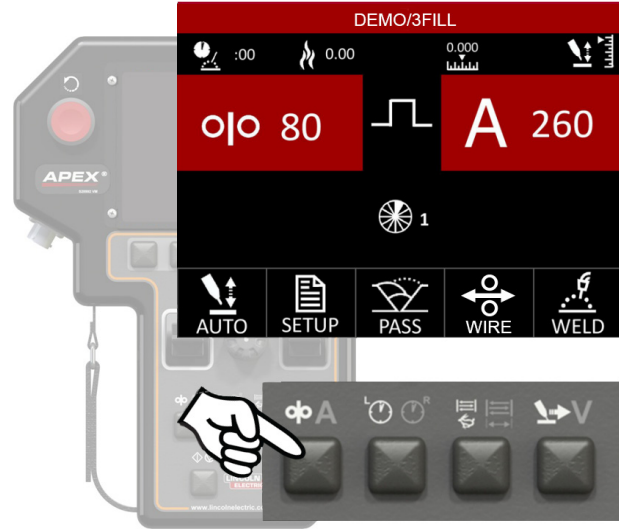

The Idle Screen shows the Wire Feed and Amps Peak values as indicated by the Peak symbol between the two values.

When enabled, pressing the WFS/A button again will display the background values as indicated by the background symbol between the two values.

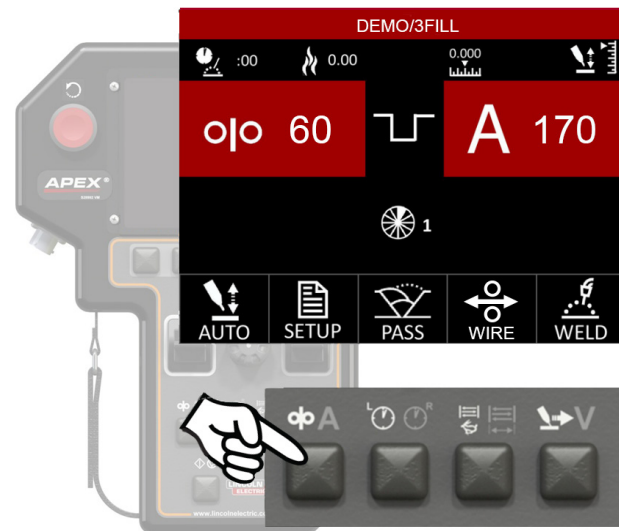

Press the Wire Feed Speed/Amps button again.

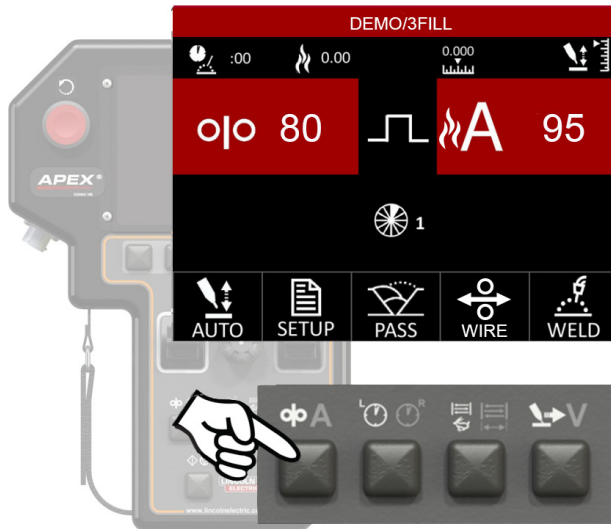

If Hot Wire Amp values are included in the weld variable configuration, the Idle Screen shows the Wire Feed and Hot Wire Amps Peak values.

Press the Wire Feed Speed/Amps button again.

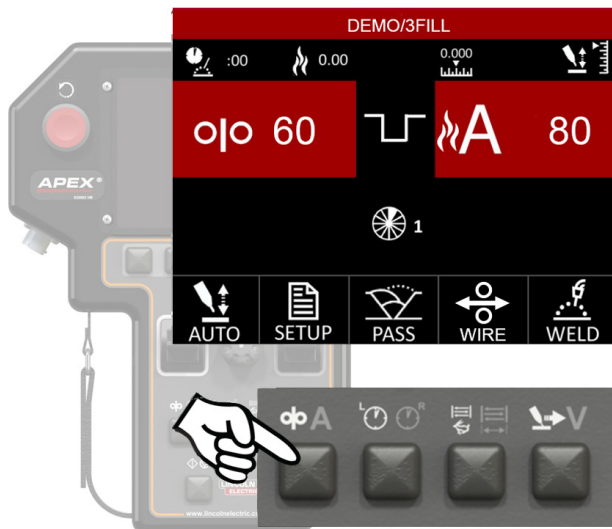

If Wire Feed Speed and Hot Wire Amp Background values are included in the weld variable configuration, the Idle Screen shows the Wire Feed and Hot Wire Amps Background values.

Continuing to push the Wire Feed Speed/Amps button will cycle through displays of all the available Wire Feed Speed, Amps, and Hot Wire Amps values.

Pressing this menu button will open the Dwell Menu button options.



Pressing this menu button will open the Oscillation Menu Options.





Pressing the menu button above opens the Travel/Voltage Menu Options.

If the Volts Peak value is included in the weld variable configuration as shown above, the Idle Screen shows the Travel value with the Volts Peak value.



If the Volts Background value is included in the weld variable configuration as shown, the Idle Screen shows the Travel value with the Volts Background value.

For each of the Menu Option Screens, the variables shown on the screen can be changed using the left and right toggles. These changes can be made while idle or welding.

Idle Screen Buttons

The Idle Screen – see **FIGURE 7 - Idle Screen Default** – will change depending on which menu button has been selected. Some items in the Selection button windows will change depending on system configurations.

1. AUTO HEIGHT -

- **Short Press** - Turns Auto Height on and off

2. SETUP -

- **Short Press** - Navigates to the Setup Screen



FIGURE 7 - Idle Screen Default

3. PASS -

- **Short Press** - Switches to the next pass in the weld program (if available)

4. WIRE FEED -

- **Short Press** - Enables or disables wire feeding.

5. TEST/WELD -

- **Short Press** - Switches between weld and test modes (FIGURE 8 shows system in Weld Mode)

6. LEFT TOGGLE (White Border) -

- **Short Press** - Changes the value displayed in the top left box. In the example, **FIGURE 7 - Idle Screen Default** – the value will change in the left dwell box)

7. STEERING KNOB -

- **Rotate** - Moves the oscillation in and out
- **Short Press** - Centers the oscillation
- **Long Press** - Starts/stops oscillation test

8. RIGHT TOGGLE (Gray Border) -

- **Short Press** - Changes the value displayed in the top right box (in the example above, **FIGURE 7 - Idle Screen Default**, it will change the value in the right dwell box)

9. WIRE FEED/AMPS -

- **Short Press** - Wire Feed/Amps options
- **Long Press** - Navigates to the Jog Screen

10. DWELL -

- **Short Press** - Dwell options
- **Long Press** - Navigates to the Dwell Jog Screen

11. OSCILLATION -

- **Short Press** - Oscillation options
- **Long Press** - Navigates to the Oscillation Jog Screen

12. TRAVEL/VOLTS -

- **Short Press** - Travel/Voltage options
- **Long Press** - Navigates to the Jog Screen

13. START/STOP -

- **Short Press** - Starts or stops welding

14. SECTOR -

- **Short Press** - Switches to the next sector if multiple sectors are available.

15. RESET

- **Short Press** - Initiates a system reset

IMPORTANT! The reset button is not an emergency stop button. Power is still being applied to the system.

Idle Screen Test/Weld Modes

After preparing a program, it is recommended that the user test the parameters before striking an arc. The system allows for a test mode of all non-weld functions such as travel, gas purge/flow, oscillation and others.

Pressing the Weld / Test Selection button will change the system from Test to Weld mode. The icon showing in the Selection Button window denotes the mode that the system is in.

Auto Height is no longer an option while in Test mode.

From either of these modes, pressing the Start/Stop Control button will enter the Weld Screen or the Test Screen depending on which mode the user is in.

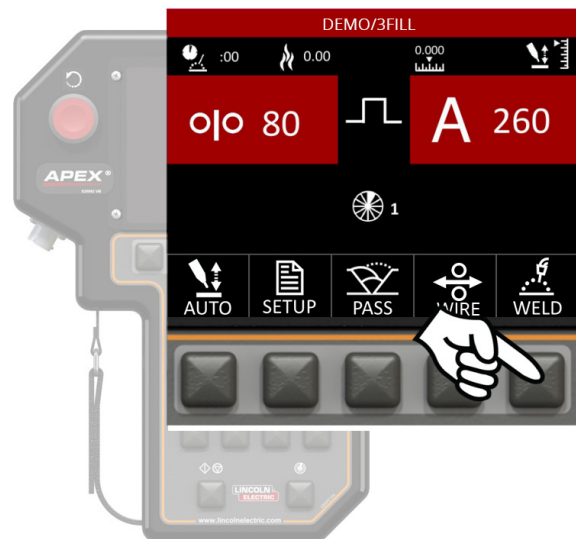

Switches to Idle Screen
Test Mode



Switches to Idle Screen
Weld Mode



Static Screen Items

There are many items common throughout the Idle, Weld and Test screens. These items give helpful information to the user throughout the setup and welding process.

1. **Arc Time** - Indicates the amount of time spent welding.
2. **Heat Input** - Displays the amount of heat input for current weld in kilojoules/cm.
3. **Sector** - Displays the current sector in the weld program, if applicable
4. **Program Name** - Displays the currently loaded weld program and program pass
Note: Program Name changes to Italics when program parameters have changed
5. **Oscillation Location** - Displays the relative location of the oscillation axis.
6. **Torch Height** - Displays the relative location of the height axis.

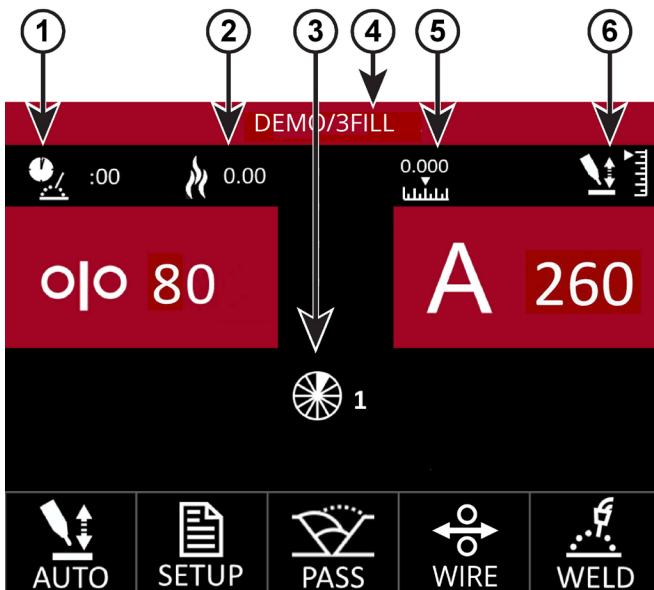

FIGURE 8 - Static Items

The screen shot above – **FIGURE 8 - Static Items** – illustrates the icons that appear on the weld screen. These icons are for information only and are not selectable variables.

Test Screen

Similar to the Weld screen, the Test Screen will show voltage and amperage feedback, but the feedback values will be zero – see **FIGURE 9 - Test Screen Options**. Pressing the menu buttons will move the user through the Menu Option Variables as shown in the Idle Screen section.

Auto Height is disabled while testing. The ability to feed wire is typically turned off while testing.

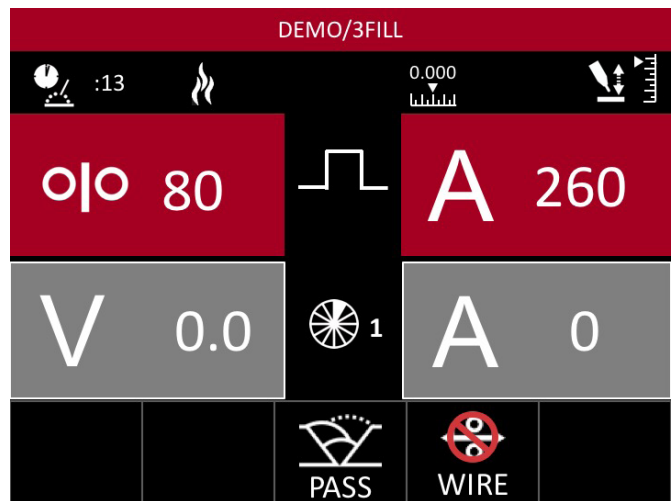

FIGURE 9 - Test Screen Options

Test Screen Buttons

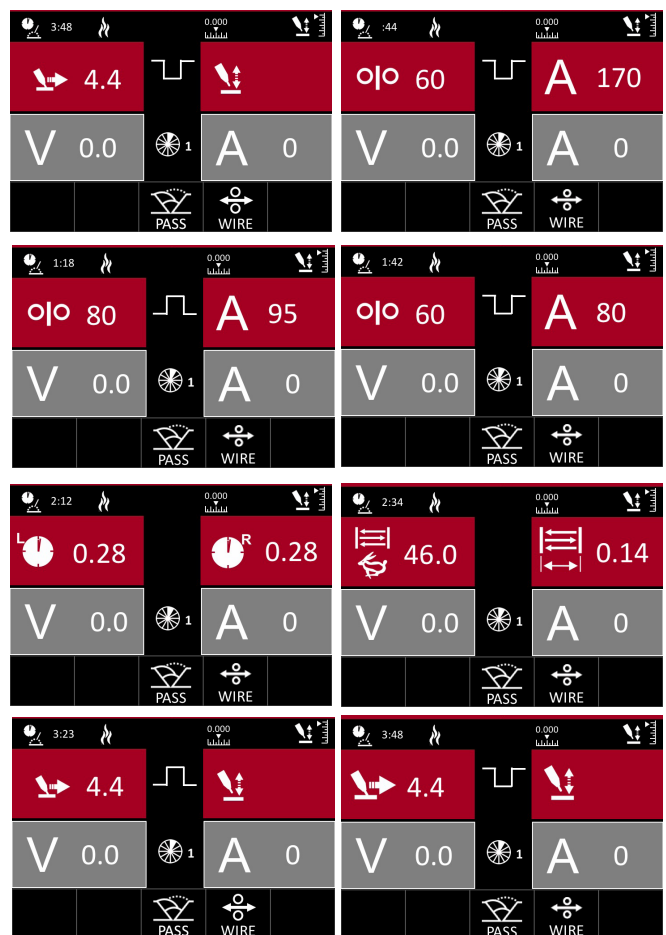

FIGURE 10 - All Test Screens

The Test Screen buttons work similar to the weld screen buttons – see **FIGURE 10 - All Test Screens**.

Weld Screen

During the weld, the screen will show voltage and amperage feedback on the screen – see **FIGURE 11 – Weld Screen Options**. Pressing the menu buttons will move the operator through the Menu Option Variables similar to **FIGURE 10 - All Test Screens**.

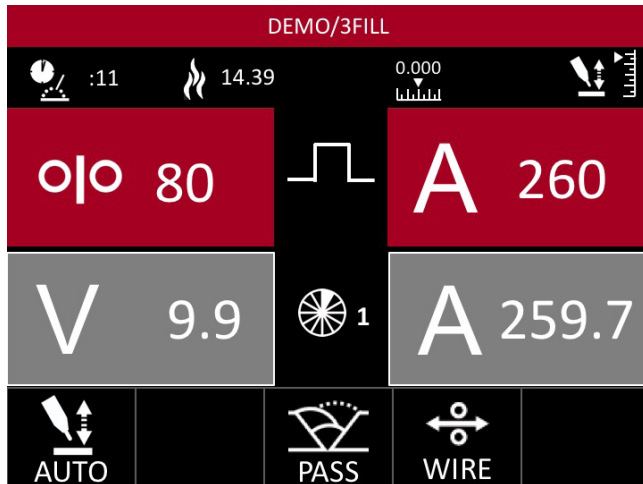

FIGURE 11 - Weld Screen Options

Autoheight and Wire Feed can also be engaged or disengaged – see **FIGURE 12 - Weld Screen Options Disengaged**.

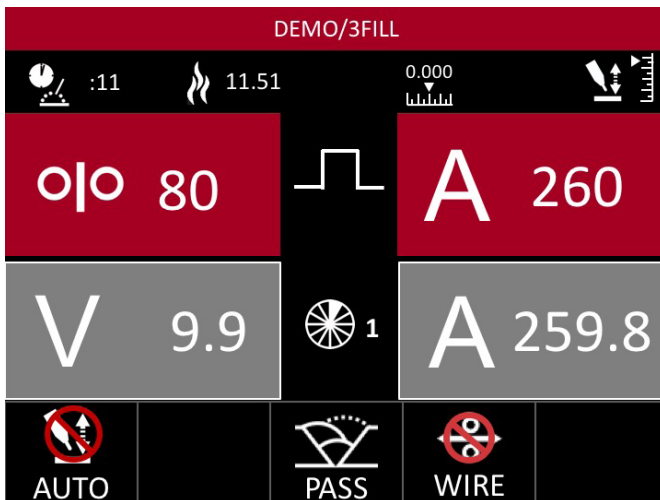

FIGURE 12 - Weld Screen Options Disengaged

Weld Screen Buttons

The Weld Screen buttons work similar to the Idle screen buttons – see examples on page 20.

Pressing the Start/Stop button during the weld halts the weld and moves into the Jog Menu.

Jog Screen

The Jog Screen is used to test movement of the system before welding. The Jog Screen can be entered from the Idle or Oscillation screens.

From the Idle Screen – see **FIGURE 13 - Idle Screen** – press and hold the Wire Feed/Amps or the Travel/Voltage menu buttons to enter the Jog Menu.

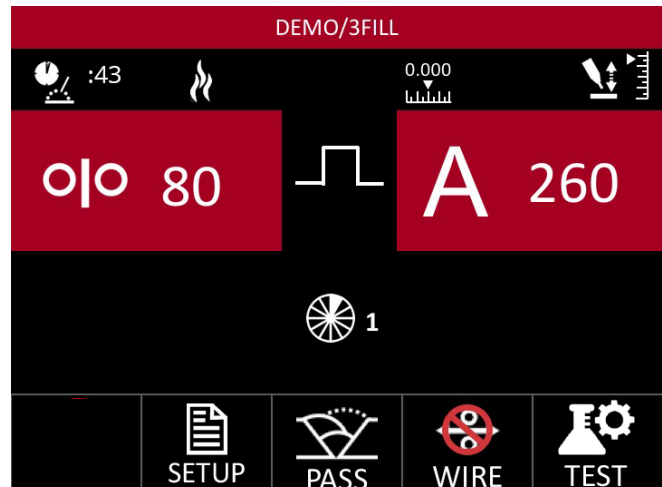

FIGURE 13 - Idle Screen

The **FIGURE 14 - Jog Mode Screen** – provides for moving the weld head along the track, adjusting torch height, purging gas and shows the icons for both.

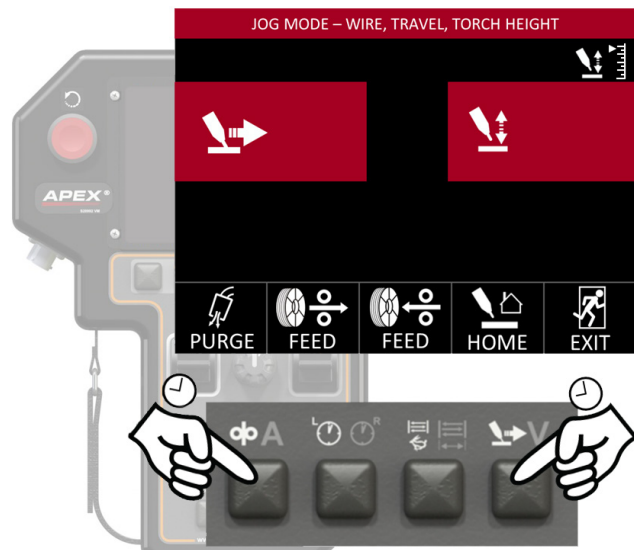

FIGURE 14 - Jog Mode Screen

Press the “Exit” selection button to return Idle screen.

Jog Buttons

The following buttons and options are available from the Jog Menu:

1. GAS PURGE -

- **Short Press** - Purge welding gas for 3 seconds
- **Hold** - Continually purges welding gas while held

2. COLD FEED FORWARD -

- **Short Press** - Feeds wire slightly
- **Hold** - Feeds wire continuously and accelerates the WFS

3. COLD FEED REVERSE -

- **Short Press** - Retracts wire slightly
- **Hold** - Retracts wire continuously and accelerates the WFS

Note: Be sure to keep the spool tight as the wire is retracted

4. HOME -

- **Short Press** - Returns the weld head to starting position on the track. The starting position is determined by previous weld or test start.

5. EXIT -

- **Short Press** - Returns to Idle Screen

6. LEFT TOGGLE (White Border) -

- **Short Press** - Travels forward or backward slightly

- **Hold** - Ramps travel speed

7. STEERING KNOB -

- **Rotate** - Moves the oscillation in and out

- **Short Press** - Centers the oscillation

- **Long Press** - Starts/stops oscillation test

- **Short Press** - Adjusts the torch up and down

- **Hold** - Ramps adjustment speed

9. WIRE FEED/AMPS -

- **No Effect**

10. DWELL -

- **Short Press** - Navigates to Oscillation screen Dwell option

11. OSCILLATION -

- **Short Press** - Navigates to Oscillation screen; width/speed option

12. TRAVEL/VOLTS -

- **No Effect**

13. START/STOP -

- **No Effect**

14. SECTOR -

- **No Effect**

15. RESET

- **Short Press** - Initiates a system reset

IMPORTANT! The reset button is not an emergency stop button. Power is still being applied to the system.

Note: In dual feeder setups, the active wirefeeder is determined by the direction last traveled.



FIGURE 15 - Jog Menu Screen

Oscillation Screen

The Oscillation Screen is used to test and adjust system oscillation before welding. To enter, press and hold the Dwell or Oscillation menu buttons while in the Jog or Idle or Weld screens.

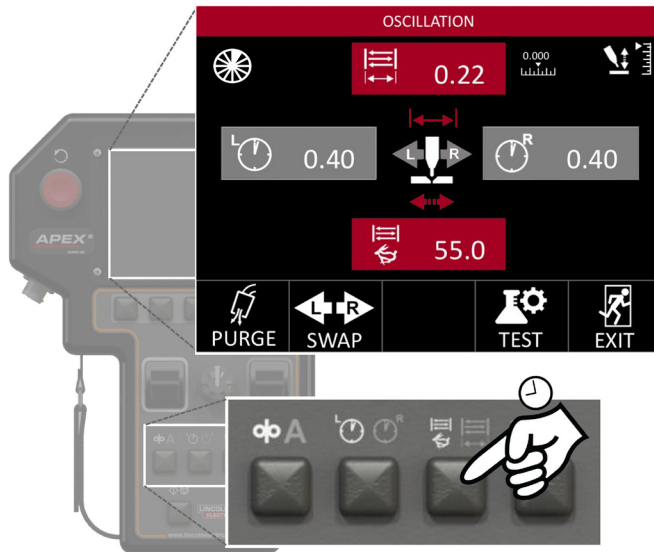

From the Idle screen, pressing and holding the Oscillator Menu Button will present the user with the option to change the oscillation width and the oscillation speed. From the Idle screen, holding down the Dwell Menu Button will present the user with the option to change the left and right dwells.

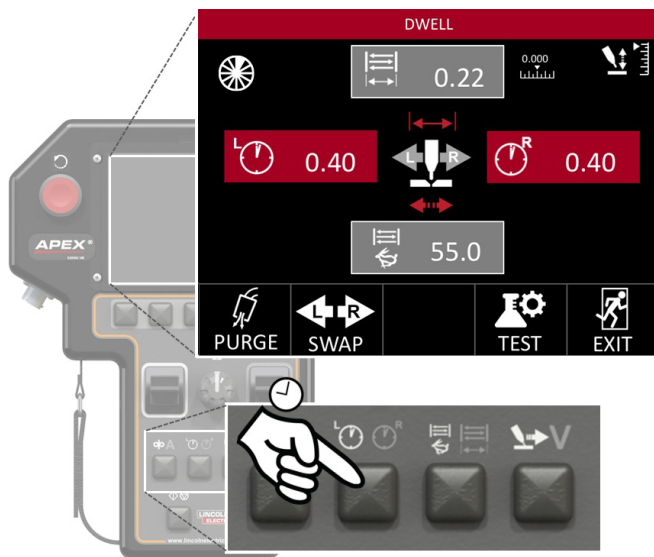

In either screen, use a short press to switch between Oscillation and Dwell. The items highlighted in red are the variables that can be changed.

Press the SWAP selection button to be taken to the Travel Setup Screen.



Travel Setup is discussed in the Travel Setup Screen section on page A-28. This screen allows the user to quickly change weld head orientation or change the weave pattern.

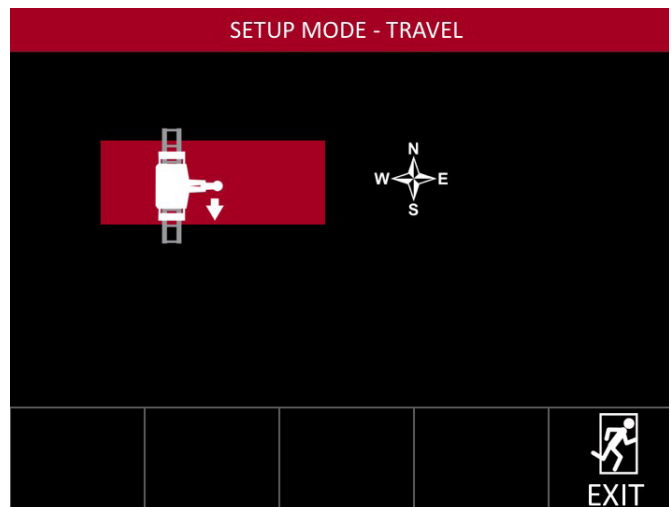

Press the “Exit” selection button to return to the Jog Screens. Once all parameters have been input and verified, exit out of the Jog Screen to return to the Weld (also call the “Idle”) Screen.

Oscillation Buttons

The following buttons and options are available from the Oscillation Menu:

1. **PURGE -**
 - **Short Press** - Purge welding gas for 3 seconds
 - **Hold** - Continually purges welding gas while held
2. **L/R SWAP-**
 - **Short Press** - Navigates to the Travel Direction Setup Screen
3. **N/A**
 - **No Effect**
4. **TEST/WELD -**
 - **Short Press** - Starts/Stops oscillation test
5. **EXIT -**
 - **Short Press** - Returns to Idle Screen
6. **LEFT TOGGLE (White Border) -**
 - **Short Press** - Increases or decreases Left Dwell time or Oscillation Width
 - **Hold** - Increases increment speed
7. **STEERING KNOB -**
 - **Rotate** - Moves the oscillation in and out
 - **Short Press** - Centers the oscillation
 - **Long Press** - Starts/stops oscillation test
8. **RIGHT TOGGLE (Gray Border) -**
 - **Short Press** - Increases or decreases Right Dwell time or Oscillation Speed
 - **Hold** - Increases or decreases value continuously
9. **WIRE FEED/AMPS -**
 - **Short Press** - Navigates to Jog Menu
10. **DWELL -**
 - **Short Press** - Switches to Dwell option (when in Oscillation option, otherwise no effect)
11. **OSCILLATION -**
 - **Short Press** - Switches to Oscillation option (when in Dwell option, otherwise no effect)
12. **TRAVEL/VOLTS -**
 - **Short Press** - Navigates to Jog Menu
13. **START/STOP -**
 - **No Effect**
14. **SECTOR -**
 - **No Effect**



FIGURE 16 - Oscillation Screen

15. RESET

- **Short Press** - Initiates a system reset

IMPORTANT! The reset button is not an emergency stop button. Power is still being applied to the system.

Setup Screen

The setup screen allows the user to set all parameters for welding. Please note that this screen can only be accessed by authorized supervisors set up in the “Users” menu. This is explained further in the Users Setup Screen section.

The Setup Screen – see **FIGURE 17 - Setup Mode** – can be accessed from the test or weld mode, but it is not accessible while welding. Press the Setup Selection button to enter into the setup screen.

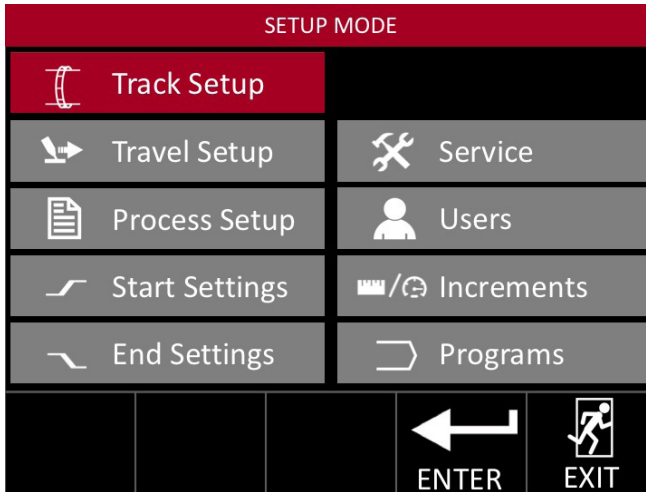

FIGURE 17 - Setup Mode

Once in the Setup Menu, the user has access to multiple system screens.



To select the individual screens, the user moves the red cursor to the desired field using the Left Toggle – see **FIGURE 18 - Setup Screen Toggle** (White Border), and presses the Enter Selection button. Pressing Exit will return the user back to the Idle Screen.

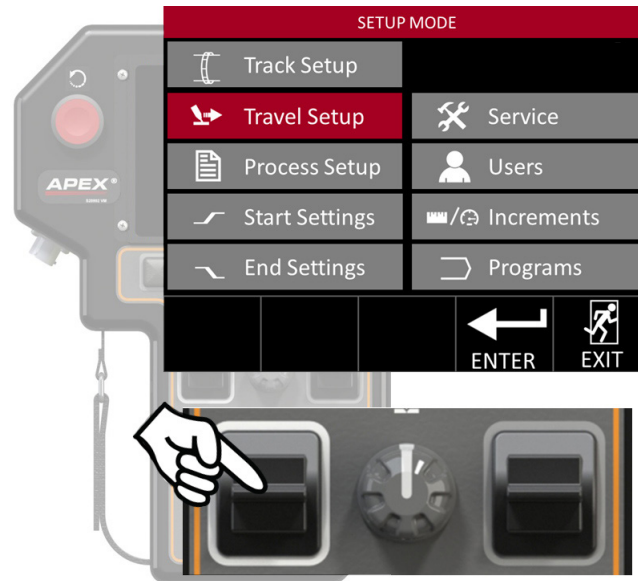

FIGURE 18- Setup Screen Toggle

Setup Screen Options

Track Setup - selects from internal or external track, flat track and the size of the pipe (where applicable).

Travel Setup - change the steering controls based on where the operator is standing in relation to the track, and set up the weave pattern.

Process Setup - sets up the weld process.

Start Settings - adjustment specific to the programs affecting how the system will react when the weld starts.

End Settings - adjustment specific to programs affecting how the system will react when the weld ends.

Service - access to current software information and can change certain motion settings, as well as monitor production, faults and tests.

Users - assigns operator and supervisor codes for the system.

Increments - allows limits and the increment value of each welding variable to be set. This screen also enables the user to choose between imperial and metric units.

Programs - The Programs screen is where all programs are saved, loaded or deleted or copied.

Track Setup

The Track setup screen presents the user with several options. From this screen the operator can change the type of track, the size of the track and the size of the pipe.

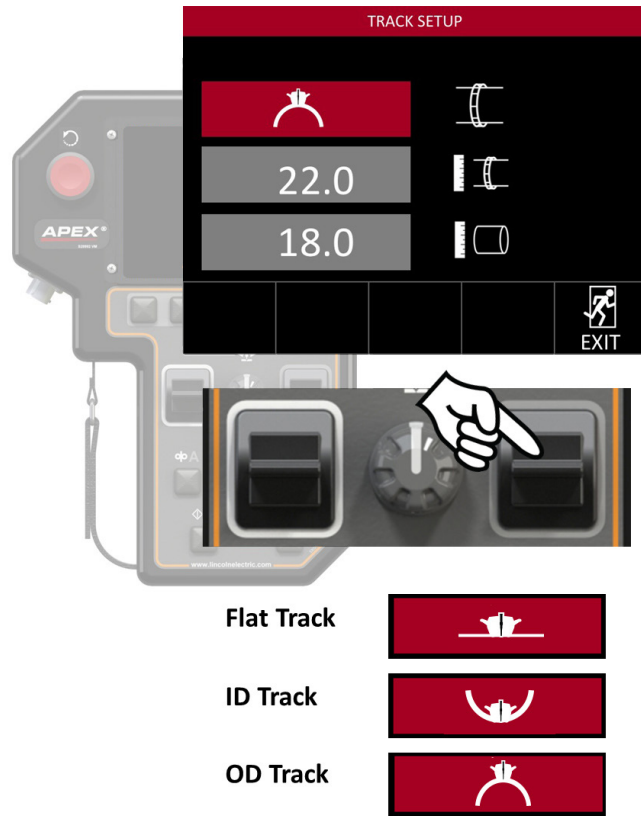

Track Type

The first selectable option is track type. With the track type field highlighted in red, the user is able to switch between the different types of tracks. These tracks consist of:

- **Outside Diameter (OD) Track**
- **Inside Diameter (ID) Track**
- **Flat Track**

With both the Outside and Inside Track options, the user is required to enter the track ring size and the pipe size. The correct numbers need to be input for calibration of the travel speed.

Track Ring Size

Track sizes range from 4 to 100 inches in increments of 2 inches. Pressing and holding the right toggle will increase the speed at which the values change. Use the nominal sizes for the track rings. **THESE NOMINAL SIZES ARE STAMPED INTO THE TRACK.**

Pipe Size

The third field that can be changed is the pipe size. This can range from 4 inches to 100 inches. The value can be adjusted in increments of 0.01 inches. Holding the right toggle for longer than 2 seconds will amplify the speed at which the values increase.

Heavy Wall Pipes

Heavy wall pipes may require the user to change the pipe size in later passes.

Example: A 20 inch Schedule 120 pipe has an OD of 20 inches and an ID of 17 inches. The pipe diameter for the root pass should be entered as 17.00 inches, then increased as the weld progresses outward. This will help to maintain an accurate welding travel speed throughout the weld.

Note: To see additional OD and ID pipe and tube size information, please refer to the “Standard Schedule Pipe and Tube Chart” on **page G-54**.

Travel Setup Screen

The travel setup allows the supervisor to set how the travel controls will work while welding.

Travel

The operator has the option of choosing how the weld head is oriented on the track. Setting the orientation and travel direction allows for intuitive operation.

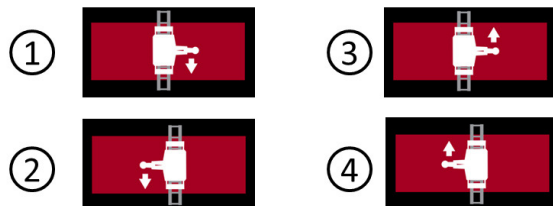
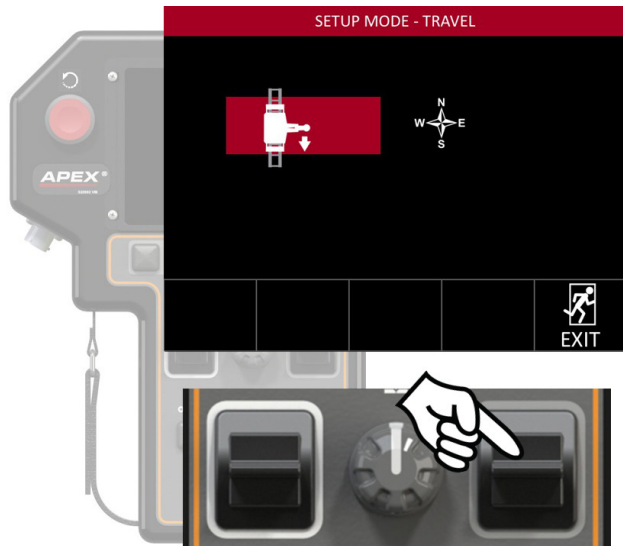

With the travel field highlighted, the weld head orientation and travel direction can be selected. There are four different options available. All directions refer to the weld head and are in relation to the users view facing the weld head.

1. Facing Right, Traveling Down
2. Facing Left, Traveling Down
3. Facing Right, Traveling Up
4. Facing Left, Traveling Up

Process Setup Screen

The Process Setup Screen, see **FIGURE 19 - Process Setup** – allows the user to select from various options to determine the variables in the weld.

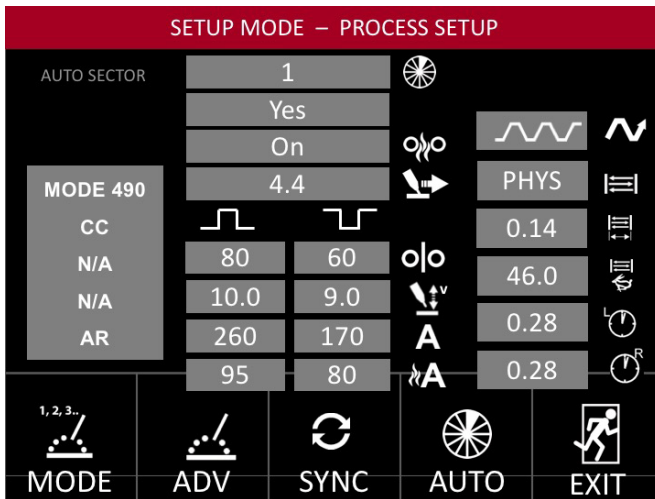

FIGURE 19 - Process Setup

Standard Process Options

Certain process options should be set up for every weld and every sector. Several of the options have both a Peak and a Background value associated with them for use when Pulsed Welding is selected. Standard process options include:

- **Sector** - determines which sector options are being set out of eight possible sectors. If it is enabled the gray field below it will say “Yes.” If it is not enabled, the field below will say “No.”
- **Hot Wire Enable** - determines whether the Hot Wire feature is enabled when available.
- **Travel Speed** - sets the electrode travel speed.
- **Wire Speed** - sets wire feed speed and can have both a Peak and Background value when Pulsed Welding is selected.
- **Torch Height (Voltage)** - determines the set point for torch height, which is how close the torch is to the work surface. Can have both a Peak and Background value when Pulsed Welding is selected.
- **Amperage** - Indicates the welding amperage. Can have both a Peak and Background value when Pulsed Welding is selected.
- **Hot Wire Amperage** - amperage applied to the wire when the Hot Wire feature is enabled. Can have both a Peak and Background value when Pulsed Welding is selected. Access to this variable is provided only when Hot Wire equipment is available.

The four process options that can have both a Peak and Background value associated with them – **Wire Speed, Voltage, Amperage, Hot Wire Amperage** – are displayed at the bottom center of the Process Setup screen, see **Figure 19 - Process Setup**.

If both Peak and Background values are available, both values will be displayed; the Peak value on the left under the Peak icon and the Background value on the right under the Background icon.

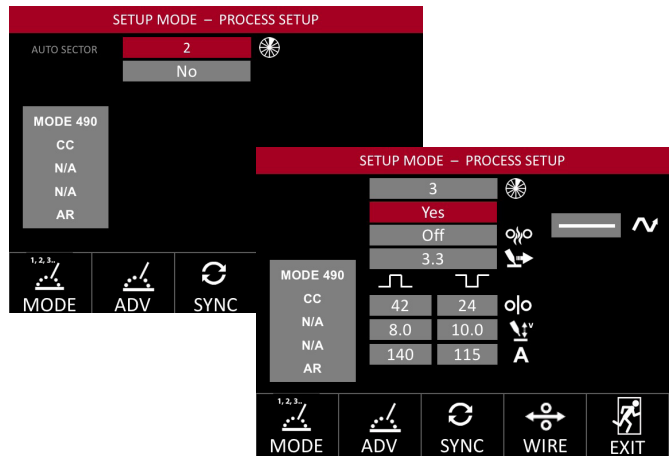

If only a single value is available, only that value will be displayed. The configuration of Peak and Background values for these variables will be discussed in the **Sync Mode Screen** section.

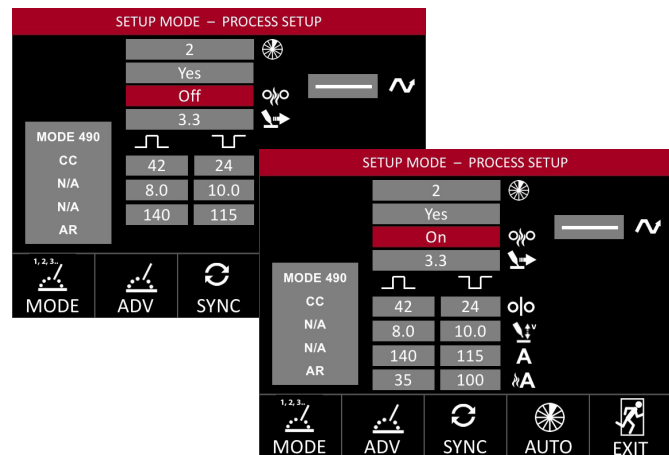

Enabling a sector presents the available process options for that sector. Without multiple sectors enabled, the system will only register one sector for the entire weld and the Idle, Weld and Test screens will not show the sector icon.

Enabling the Hot Wire feature presents the Hot Wire Amperage values.

Weave Process Options

- **No Weave** - when no weave is selected, the oscillator does not move during the welding process. The user can still manually steer the oscillator.
- **Step Travel** - during step travel the travel speed stops during the dwells. This allows the energy to be directed to the side walls.

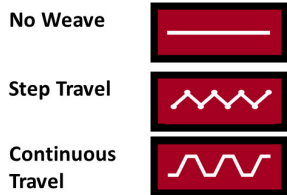
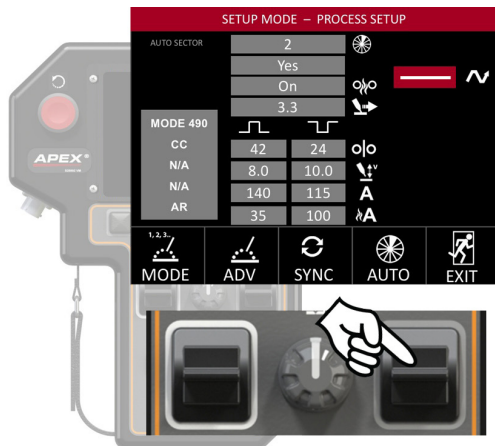

- **Continuous Travel** - continuous travel will continue travelling throughout the weld process, as well as during oscillation excursion and dwells. When either step Travel or Continuous Travel is selected as the weave value, additional Oscillation Settings become available.

Oscillation Settings include the following:

- **Oscillation Method** - Oscillation can be Physical Oscillation where the oscillator physically moves the torch or Magnetic Oscillation where the arc is manipulated magnetically.
- **Oscillation Width** - Determines the width of the oscillation weave.
- **Oscillation Speed** - The speed at which the torch (or arc) moves during oscillation.
- **Left Dwell** - How long the torch remains on the left side of oscillation.
- **Right Dwell** - How long the torch remains on the right side of oscillation.

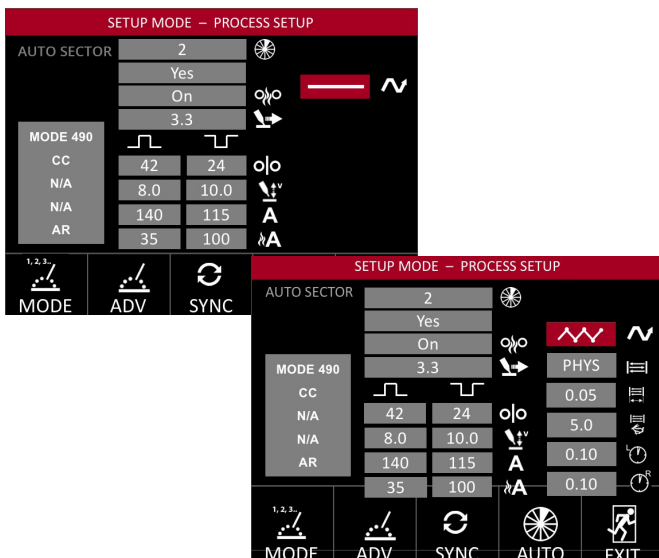

Mode Select

The weld mode is determined by the wire size, type, process and type of gas being used. Refer to the Power Wave operator’s manual for additional information about weld modes. The system can be a guide when the user is not sure which mode is appropriate for their application.



Pressing the Modes selection button will take the user to the Mode Select Screen.

The available weld modes are displayed in sequential order. These available modes depend on the available equipment.

SETUP MODE – MODES	
MODE	DESCRIPTION
3	N/A, N/A, GTAW, Touch Start TIG
8	N/A, N/A, GTAW, TS TIG Pulse
375	N/A, N/A, GTAW, HF TIG
376	N/A, N/A, GTAW, HF TIG Pulse
490	N/A, N/A, GTAW, AUTO TIG
...

9 Modes

← ENTER
EXIT

FIGURE 20 - Mode Screen

Use the left toggle or turn the steering knob to choose an available weld mode then press the Enter Selection button to select the mode as the current weld mode.

Advanced Process Setup

Certain weld modes have advanced settings specific to that mode or process. Pressing the ADV Selection button on the Process Setup screen will present the user with the advanced options associated with the selected weld mode, see **FIGURE 21** and **FIGURE 22 - Advanced Process Setup and Advanced Process with Hot Wire**. When Hot Wire equipment is available and Hot Wire is enabled, the advanced screen also displays the Hot Wire weld mode.



Advanced Options

Options available depend on the selected weld mode. See the Power Wave settings for a full breakdown and explanation of advanced options.

Wave Controls

Some typical wave controls are:

- Frequency
- Background
- Transition Speed

Note: Wave controls are limited to 12 characters when displayed on the screen, e.g., “Transition Speed” will be displayed as “Transition S.”

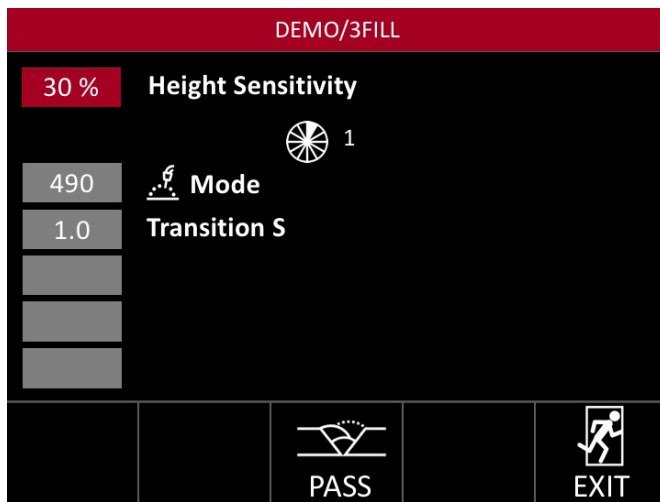

FIGURE 21 - Advanced Process Setup

Height Sensitivity

Height sensitivity is a global setting available regardless of the weld mode selected. The operator can program the system to react to changes following the profile of the joint.

Higher sensitivity will result in faster adjustment which could cause hesitation in torch height and abrupt changes in the weld as shown in **FIGURES A and B**.

Maintaining a low height sensitivity allows for higher quality and more consistent welds. This includes adjusting for out-of-round pipes, maintaining heat input and helping with puddle control on the joint profile.

It is recommended that the operator start the weld at a lower sensitivity setting for the best performance. This will also assist in avoiding an over reaction to changes in the structure of the materials being welded.

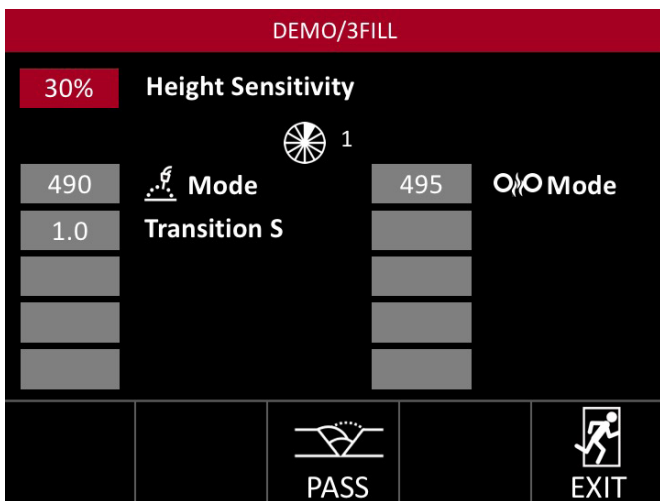

FIGURE 22 - Advanced Process with Hot Wire

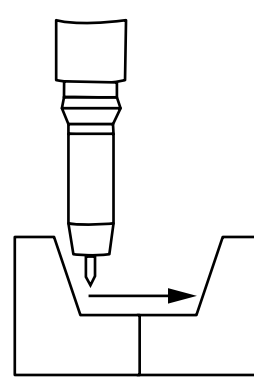

FIGURE A - JOINT Low Sensitivity < 50

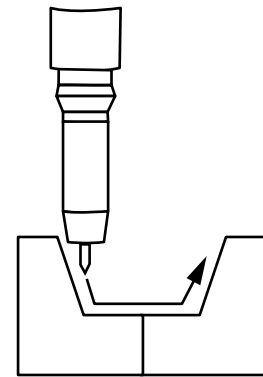

FIGURE B - JOINT High Sensitivity > 50

Sync Mode Screen

Synchronization refers to the relationship of alternating periods of Peak and Background output levels for the following four synchronized weld variables during welding: **Wire Speed**, **Voltage**, **Amperage**, and **Hot Wire Amperage**.

There are three available synchronization modes; No Sync, Sync to Oscillation, and Sync to Pulse as shown in **FIGURE 23 - Sync Mode Options (No Sync)** (showing No Sync), **FIGURE 24 - Sync to Oscillation**, and **FIGURE 25 - Sync to Pulse**.

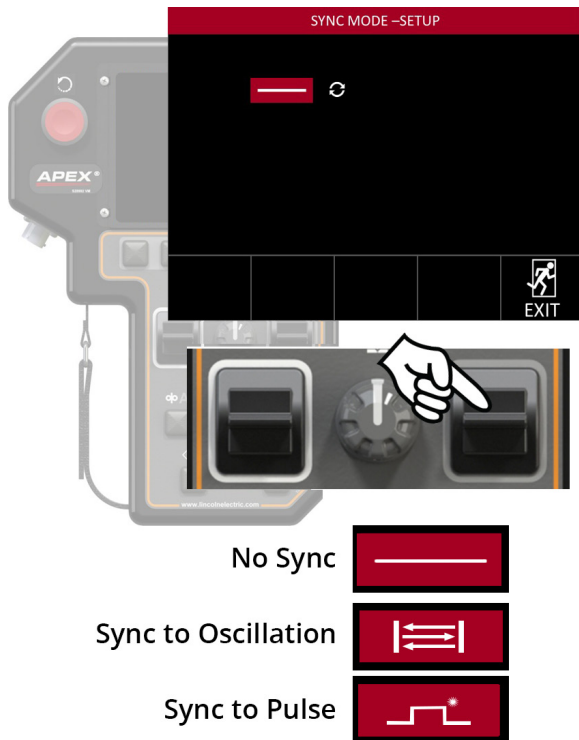

FIGURE 23 - Sync Mode Options (No Sync)

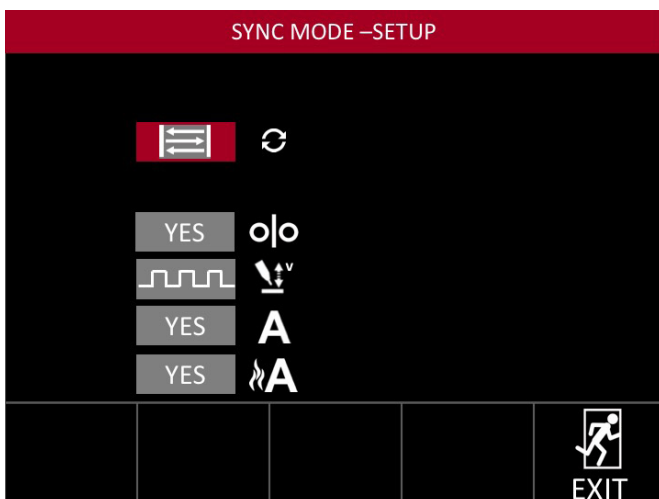

FIGURE 24 - Sync to Oscillation

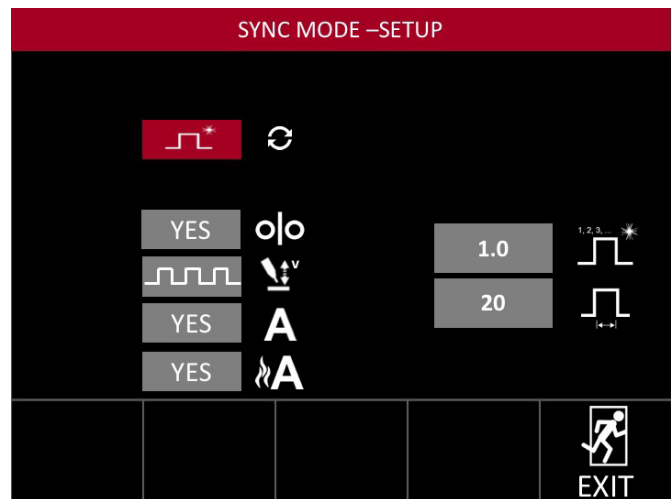

FIGURE 25 - Sync to Pulse

A choice of **No Sync** as shown on the Pendant screen in **FIGURE 23 - Sync Mode Options** means that none of the four synchronized weld variables will alternate between Peak and Background output levels. Instead, it will maintain the same output level throughout the weld. With the choice of either **Sync to Oscillation** or **Sync to Pulse**, the user is allowed to choose which of the synchronization variables will alternate between the Peak and Background output levels and set the parameters that determine the timing of the Peak and Background periods.

When **Sync to Oscillation** is in effect during Peak, the system dwells on either side of the oscillation width and during the Background period, the system traverses the oscillation width.

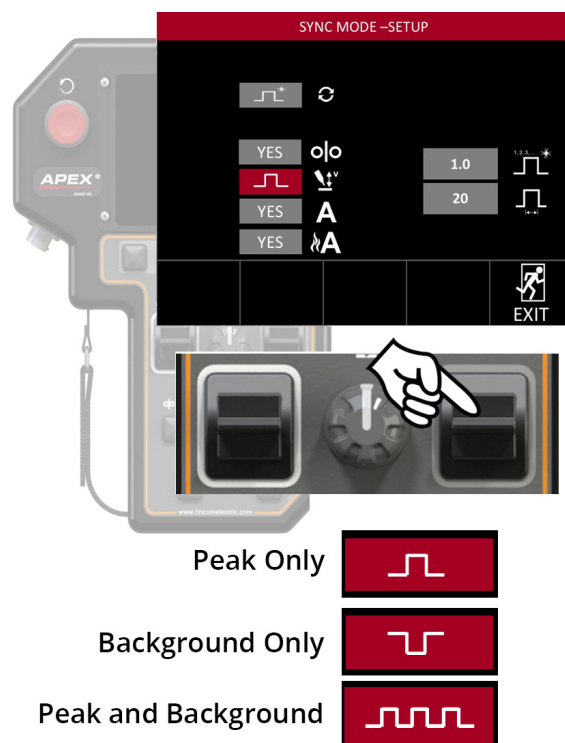

FIGURE 26 - Voltage Sync Values

When **Sync to Pulse** is in effect, Peak and Background periods are determined by setting the pulses per second parameter and the primary width parameter. The pulses per second parameter range in value from 0.1 to 10.0 pulses per second in 0.1 increments and will determine how long it takes to complete one Peak/Background cycle.

For example, a pulses-per-second parameter value of 1.0 means that on Peak/Background cycle takes 1.0 seconds; a pulses-per-second value of 10.0 means that there are 10 Peak/Background cycles each second so a complete Peak/Background cycle takes only 0.1 seconds; a pulses-per-second value of 0.1 means that there is only 0.1 of a Peak/Background cycle each second so a complete Peak/Background cycle would take 10 seconds.

The primary width parameter is a percentage value that ranges from 20 to 80 percent and determines what proportion of each complete Peak/Background cycle is allocated to Peak. For example, consider the values shown in **FIGURE 25 - Sync to Pulse** where the parameter value for pulses per second is set to 1.0 and the parameter value for primary width is set to 20.

In this case, there will be 1 Peak/Background cycle each second and 20 percent of each cycle will be allocated to Peak (the remaining 80 percent of the cycle will be allocated to Background). In this case, Peak output values will be in effect for 0.2 seconds followed by 0.8 seconds of Background output values and so on.

For Sync to Oscillation and Sync to Pulse selections, the values associated with the Wire Speed, Amperage, and Hot Wire Amperage on the Sync Mode screen indicate whether the associated weld variable is to be synchronized with Peak and Background cycles. A value of 'Yes' means it will be synchronized and a value of 'No' means it will not. The value associated with Voltage can take one of three values as shown in **FIGURE 26 - Voltage Sync Values**.

Selecting the Peak Only option means that the Peak voltage value will be output at all times when welding. Selecting the Background Only option means that the Background voltage value will be output at all times when welding. Selecting the Peak and Background option means that the voltage output while welding will alternate between Peak and Background values.

The synchronization choices made on the Sync Mode screen will affect the options and selections that are available on other screens; particularly the Process Setup screen and the Idle, Test, and Weld screens. When weld variables are synchronized, both values will be available on these screens; when not synchronized, only one value will appear.

Sector Setup Screen

As discussed in the Process Setup section, there can be from one to eight weld sectors enabled in a weld program. Conceptually, the weld sectors can be pictured as sections on the surface of a horizontally positioned pipe. For example, a weld program could have four defined sectors intended to correspond to the entire outside surface of a pipe; a sector associated with the area between the 12 o'clock and the 3 o'clock position, a sector associated with the area between the 3 o'clock and 6 o'clock positions, a sector associated with the area between the 6 o'clock and the 9 o'clock positions, and a sector associated with the area between the 9 o'clock and 12 o'clock positions.



FIGURE 27 - Sector Setup Screen

As discussed in the Process Setup section, Sector 1 is required to be enabled. If a weld program has only one sector enabled, it will be Sector 1. When multiple sectors are enabled, the effective weld parameter values can transition those associated with one enabled sector to those associated with the next enabled sector during a weld.

The transition between sectors can be initiated manually by the operator or can occur automatically at predetermined points using the Auto-Sector feature.

If the Sector button is pushed while welding, using a weld process that has multiple weld sectors enabled, the weld parameter values will transition from those in effect when the button was pushed to those associated with the next enabled weld sector in the process. The transition period is two seconds during which the weld parameter values gradually transition to those of the next sector. This is the method used to manually transition from one weld sector to the next.

In some cases the weld sector transitions occur automatically provided certain conditions are met. First, the setup selected on the Track Setup screen must be for an outside track ring (OD Track) and the values selected for track ring diameter and pipe diameter must precisely match those of the physical setup.

Second, the weld head must be equipped with an inclinometer interface. Third, a weld process with multiple sectors enabled must be active. If the above conditions are met, automatic sector transition points can be defined on the Sector Setup screen shown in **Figure 27- Sector Setup Screen**. The Sector Setup Screen is displayed by pressing the AUTO selection button on the Process Setup screen.

On the Sector Setup screen, sector transition points are specified in terms of degrees offset from the 12 o'clock position of a horizontally positioned pipe. Direction of travel is important in determining the values associated with the sector transition points.

If a clockwise travel direction is specified, degree values start at the 12 o'clock position with zero degrees and increment to 359° in a clockwise direction; the 12 o'clock position will be zero degrees, the 3 o'clock position will be 90°, the 6 o'clock position will be 180°, and the 9 o'clock position will be 270°.

If a counter-clockwise travel direction is specified, degree values start at the 12 o'clock position with 0 degrees and increment to 359° in a counter-clockwise direction; the 12 o'clock position will be 0 degrees, the 3 o'clock position will be 270°, the 6 o'clock position will be 180°, and the 9 o'clock position will be 90°. On the right side, the Sector Setup screen displays a representation of a cross-section of a horizontally positioned pipe with sector markers placed on the pipe perimeter showing the position of the sector transition point for each enabled sector in the weld process based on the travel direction.

On the left side of the screen, the same information is displayed numerically in a table. In the middle of the screen at the top, the current position of the weld head (inclinometer value) is displayed with respect to the specified travel direction.

In the middle of the screen below the weld head position display, the selected travel direction is displayed by highlighting either the clockwise or counter-clockwise arrow. At the top left of the Sector Setup screen,

the text 'AUTO SECTOR' is shown highlighted if the auto-sector feature is enabled or grayed out if not enabled. This text is also displayed at the same location on the Process Setup screen.

On the Sector Setup Screen shown in **FIGURE 27- Sector Setup Screen** it shows sector transitions for a weld process containing four enabled sectors travelling in a clockwise direction with the auto-sector feature enabled and the weld head currently positioned at six degrees.

Pressing the DIR selection button switches the travel direction between clockwise and counter-clockwise directions.

Pressing the RESET selection button returns all available sector transitions to default locations. Default sector transition locations are those that would evenly space 8 sectors around the pipe: sector 1 at zero degrees, sector 2 at 45°, sector 3 at 90°, sector 4 at 135°, sector 5 at 180°, sector 6 at 225°, sector 7 at 270°, and sector 8 at 315°.

The sector numbers used here correspond to the sector numbers which are enabled or disabled on the Process Setup Screen. If the four sectors that were enabled in **FIGURE 27 - Sector Setup Screen** were sectors 1, 2, 3, and 5, then after pressing the RESET selection button, the sector transitions would be displayed at the following locations: 0°, 45°, 90° and 180°. Also, the numeric values displayed in the table to the left would be displayed in the 1st, 2nd, 3rd and 5th rows of the table. The other rows of the table would be blank because those sectors are disabled on the Process Setup Screen.

Pressing the Sector button (**button 14 on FIGURE 4 - Pendant Items**) turns the auto-sector feature on/off.

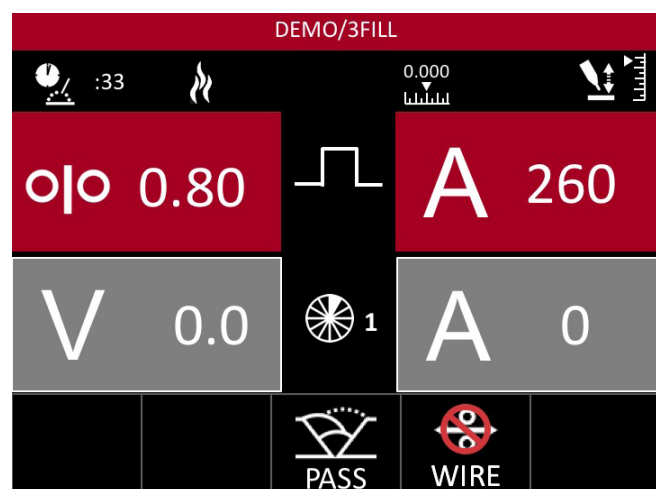

FIGURE 28 - Auto Sector Progress

The selected sector transition point on the Sector Setup screen is indicated by the highlighted entry in the table (red) as well as the highlighted sector pointer (white) on the perimeter of the pipe. Transition point selection can be done either by using the Left Toggle or by pushing the steering knob.

Once selected, a transition point can be moved by rotating the steering knob. Adjacent transition points must be separated by at least 5°. Attempting to move a transition point in the direction of an adjacent transition point that has 5° of separation will result in both transition points moving in order to maintain the minimum separation.

When testing or welding starts, the current weld head position will determine the starting weld sector and the weld parameter values associated with that sector will be in effect at the end of upslope. Once testing or welding begins, the travel speed and the pipe and track measurements are used to determine when sector transition points are reached and the weld parameter values transition to those of the next sector.

For the Sector Setup values shown in **FIGURE 27 - Sector Setup Screen**, Sector 1 weld parameter values are set to be in effect from 5° to 95°; Sector 2 weld parameter values are set to be in effect from 50° to 95°; Sector 3 weld parameter values are set to be in effect from 95° to 140°; and Sector 4 weld parameter values are set to be in effect from 140° wrapping around to 5°.

If a test or weld was initiated with the transition data shown in **FIGURE 27 - Sector Setup Screen**, it would start at the current weld head position of 6° and travel in a clockwise direction upsloping to the weld parameter values associated with sector 1.

Depending on the travel speed and the pipe and track measurements, the weld head would reach the 50° mark and the weld would transition to the Sector 2 parameter values, followed by a transition to the Sector 3 parameter values at the 90° mark, followed by a transition to the Sector 4 parameter values at the 140° mark, and unless stopped by the user, would wrap around to repeat the Sector 1 parameter values at the 5° mark.

The Auto-Sector feature does not currently provide the option to automatically stop the weld. The user, of course, can stop the weld at any point during the auto-sector process. When a test or weld starts with the auto-sector feature enabled, the progress of the weld with respect to the current sector number is displayed on the Test or Weld screen as shown in **FIGURE 28 - Auto Sector Progress**.

The current sector number is displayed next to the sector symbol, in this case '1'. The percentage value shown above the Peak symbol between the red Wire Feed and Amperage boxes indicates the proportion of the current sector remaining.

In **FIGURE 28 – Auto-Sector Progress**, the weld parameter values associated with Sector 1 are in effect and 30% of Sector 1 remains to be traversed at which time the weld parameter values will automatically transition to those of Sector 2.

Start Settings

Start settings should be set up after the process setup has been completed. The start settings screen – **FIGURE 29 - Start Settings Screen** – allows the user to adjust how the system acts when the weld starts. The start settings take effect as soon as the Start / Stop button is pressed to initiate the weld. Refer to page **G-53** to see a full timing diagram.

The settings that can be changed on this screen are:

Preflow - The amount of time (sec) that gas flows before welding begins to ensure adequate gas coverage for the weld preventing starting porosity.

Upslope - This is the amount of time (sec) it takes for the system to ramp up from start settings to welding parameters.

Start Amps -The amperage level commanded at the beginning of the weld. Level will then ramp to the welding amperage during Upslope.

Start WFS - The speed at which the wire will feed at the beginning of a weld. Value will then ramp to the welding Wire Feed Speed.

WFS Up - The amount of time (sec) taken to ramp from the Start WFS to the welding WFS.

Wire Start - The amount of time (sec) from the beginning of Upslope until wire begins to feed.

Travel Start - The amount of time (sec) from the beginning of Upslope until the weld head begins to travel.

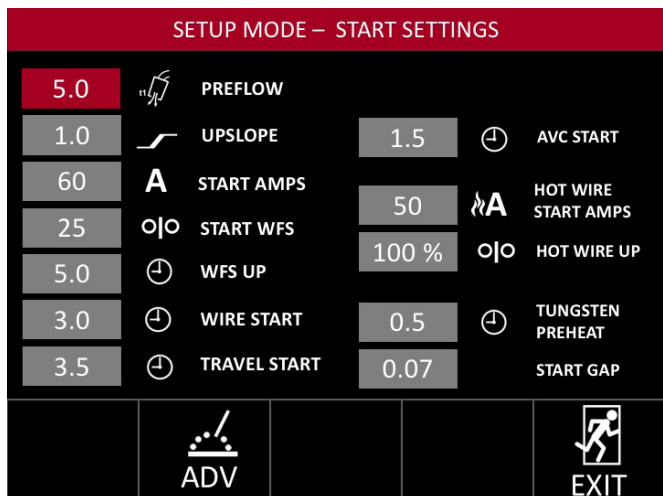

FIGURE 29 - Start Settings Screen

AVC Start

The amount of time (sec.) from the beginning of Upslope until AVC (automatic torch height control) begins. Note that this time runs concurrently with Upslope but AVC cannot start until Upslope is over. If the AVC Start value is less than the Upslope value, AVC start will occur immediately at the end of Upslope. If the AVC Start value is greater than the Upslope value, AVC start will be delayed after the end of the Upslope by an amount of time equal to the difference between AVC Start and the Upslope value (AVC Start – Upslope). For example, if Upslope has a value of 1.0 seconds and AVC start has a value of 1.5 seconds, AVC will begin 0.5 seconds after the end of Upslope.

Hot Wire Start Amps - Amperage applied to the wire when the Hot Wire Power Source is initially turned on. Value will then ramp to the welding hot wire amperage.

Hot Wire Up - The amount of time (percentage) taken to ramp from Hot Wire Start Amps to welding hot wire amperage. Value is in terms of a percentage of the WFS Up value. For example, if WFS Up has a value of 2.0 seconds and Hot Wire Up has a value of 75 percent, the amount of time it takes to ramp from Hot Wire Start Amps to welding hot wire amperage will be 1.5 seconds.

Tungsten Preheat - The amount of time (sec.) the tungsten is preheated before striking an arc.

Start Gap - Distance (in) the torch is retracted from the work when striking an arc at the beginning of the weld.

Pressing the ADV selection button on the Start Settings screen presents the Advanced Process screen as shown in either **FIGURE 20 - Advanced Process Setup** or **FIGURE 21 - Advanced Process with Hot Wire** in the Advanced Process Setup section. This allows for setting start setting values for the wave controls associated with the current weld mode.

When entering the Advance Process screen from the Start Settings screen, the symbol next to the sector icon is an 'S' rather than a sector number.

End Settings

The end settings screen, see **FIGURE 30 - End Settings Screen**, allows the user to adjust the end settings specific to the program, which affect how the system will behave at the end of the weld. End settings begin to take effect as soon as the Start / Stop button is pressed to stop the weld. Refer to page **G-53** to see a full timing diagram.

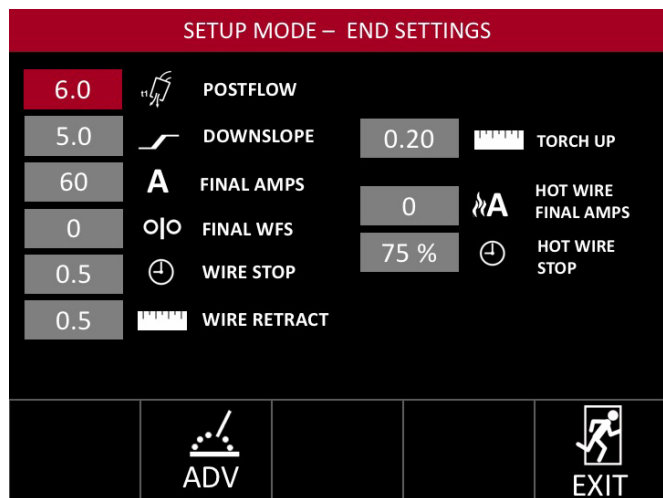

FIGURE 30 - End Settings Screen

The settings that can be changed on this screen are:

Postflow - The amount of time (sec.) the gas continues to flow after the weld to provide shielding.

Downslope - The amount of time (sec.) it takes for the system to ramp from welding parameters to the end settings.

Final Amps - The amperage level at the end of Downslope.

Final WFS - The speed at which the wire will feed at the end of the Wire Stop.

Wire Stop - The amount of time (sec) taken to ramp from welding WFS (when the Stop button is pressed) to the Final WFS. Note that if Wire Stop is longer than Downslope, wire will stop feeding and retract at the end of Downslope.

Wire Retract - The distance (in) that wire will be retracted at the end of the Wire Stop to prevent the wire from getting stuck to the base material.

Torch Up - The distance (in) that the torch is retracted after the arc is extinguished to avoid the puddle contracting the tungsten. The distance should be limited to guarantee proper gas coverage during Postflow.

Hot Wire Final Amps - Amperage applied to the wire at the end of the Hot Wire Stop.

Hot Wire Stop - The amount of time (percentage) taken to ramp from the Hot Wire Amperage level in effect at the beginning of Downslope (when the stop button was pressed) to the Hot Wire Final Amps level. Value is in terms of a percentage of the Wire Stop value.

For example, if Wire Stop has a value of 2.0 seconds and Hot Wire Stop has a value of 75 percent, the amount of time taken for the Hot Wire Stop will be 1.5 seconds. Note that if Hot Wire Stop is longer than Downslope, Hot Wire Amperage will be turned off at the end of Downslope.

Pressing the ADV selection button on the End Settings screen present the Advanced Process screen as shown in either **FIGURE 21 - Advanced Process Setup** or **FIGURE 22 - Advanced Process with Hot Wire** on pages 31 and 32.

This allows for setting end settings values for the wave controls associated with the current weld mode. When entering the Advance Process screen from the End Settings screen, the symbol next to the sector icon is an 'E' rather than a sector number.

Service Menu

The Service Screen allows for advanced welding options – see **FIGURE 31 - Service Options Page**. There are four menus available in the Service Screen: Version and Motion.

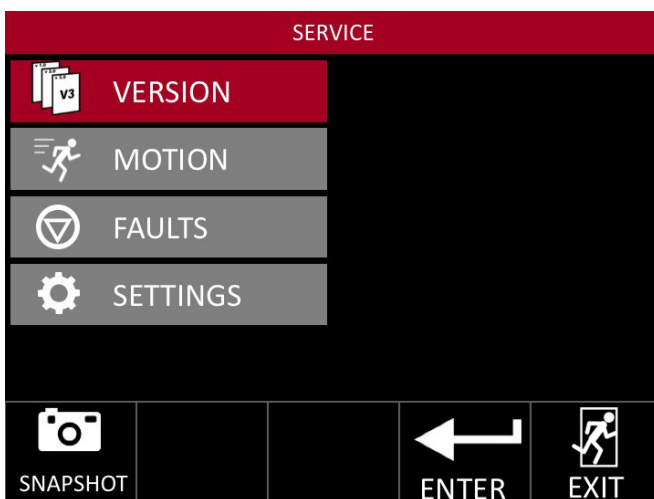

FIGURE 31 - Service Options Page

If a USB is installed the system allows for a system snapshot to be taken from this screen.

Version

The version option of the service menu shows the user information about the installed software and hardware, see **FIGURE 32 - Service Screen Version**. Page through the screen using the Next Selection button. If a USB is installed, the system allows for a snapshot to be taken from this screen.

Motion

Allows the user to select certain motions and behaviors of the weld system, see **FIGURE 33 - Service Screen Motion** for available options.

Service Motion items are:

- **Steering Increment** - Allows the supervisor to set the distance the oscillation will move for each click of the steering knob.
- **Head Orientation** - To change the torch orientation relative to the weld head the supervisor must also change the system settings in addition to physically

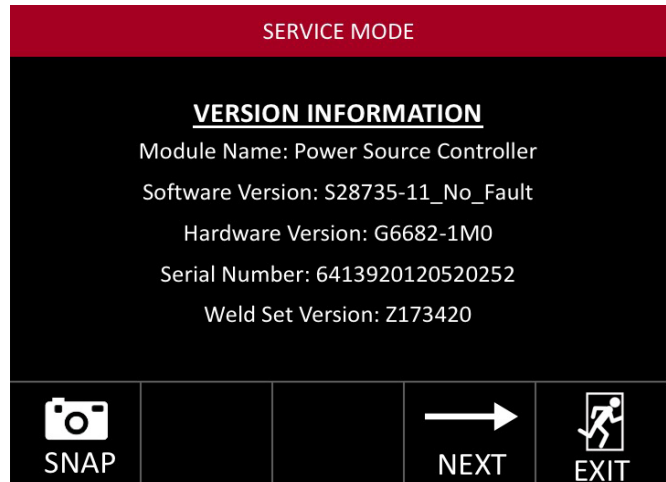

FIGURE 32 - Service Screen Version

inverting the weld head.

- **Torch Retract Distance** - Change how far the torch retracts at the end of the weld. This allows for greater retract distance when clearance is desired, and less distance when restarting the weld needs to be rapid.
- **WFS Test** - The APEX system does all calibrations internally, however in order to comply with welding standards, the system will produce the right amount of wire for the proper length of time for verification.
- **Travel Test** - The APEX system does all calibrations internally, however in order to comply with welding standards the system allows a travel test for the specified distance for verification. The speed the weld head will travel is determined by the program parameters.
- **Step Over** – When turned ON, the steering knob will control the travel motor rather than the oscillator position. The distance travelled (in) and the speed of the travel (in/min) for each steering knob click are selectable by the user – see **Figure 34 – Service Screen Step Over, page A-39**.



FIGURE 33 - Service Screen Motion

When an inclinometer is available in the weld head and the Outside Track Ring is selected on the Track /Setup screen, the CAL selection button icon is displayed at the bottom of the Motion Controls screen and the current weld head position is displayed directly above the icon, see **FIGURE 33 - Service Screen Motion** and **FIGURE 34 - Service Screen Step Over**.

Pressing the CAL selection button will calibrate the weld head inclinometer. A warning is given prior to the calibration indicating that the calibration process requires the weld ead to travel completely around the pipe – any obstructions should be removed.

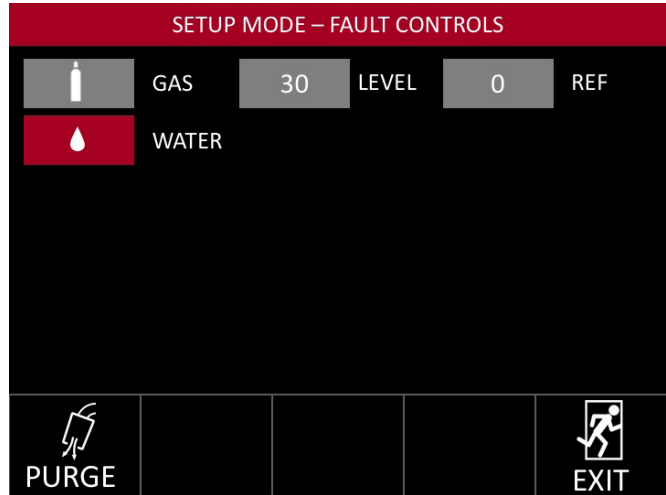

FIGURE 35 - Faults Screen On Settings

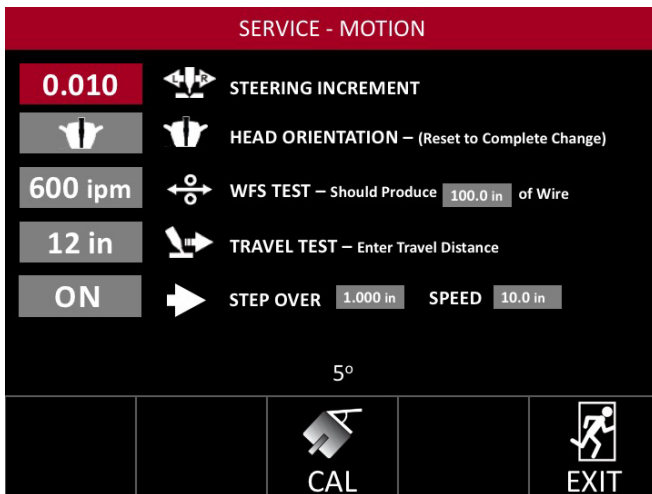

FIGURE 34 - Service Screen Step Over

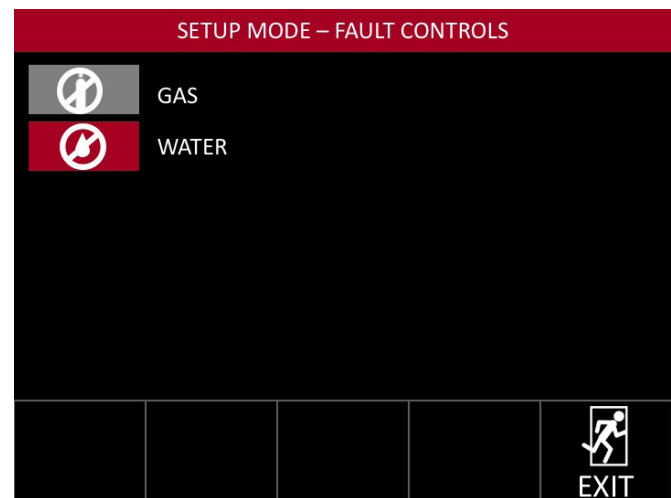

FIGURE 36 - Faults Screen Off Settings

Faults

While welding, the flow of shielding gas and/or cooling water can be monitored if the appropriate hardware is present. For gas flow, the required level can be specified. The **Faults Screen On Settings** shown in **FIGURE 35** provides access to these features.

Water flow is detected by an ArcLink® connected Cool Arc® unit.

Use the Left Toggle to select GAS or WATER and then the Right Toggle to turn monitoring ON/OFF. With gas monitoring turned ON, two additional controls are made available; a LEVEL selection to input the required level of gas flow using the Right Toggle and a REF value which will display the current gas flow value when the PURGE button is pushed.

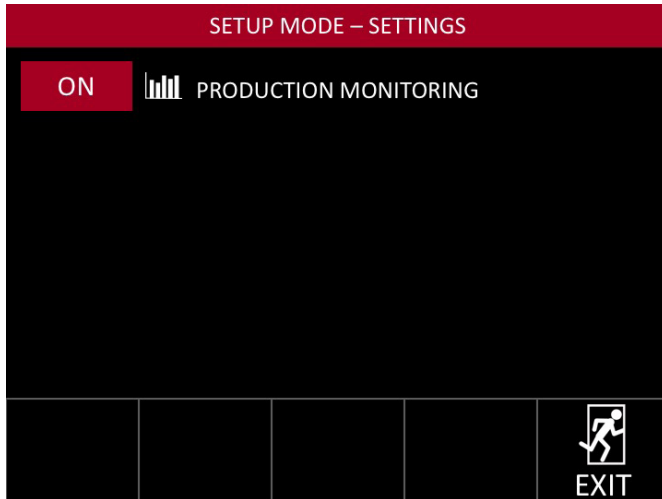

FIGURE 37 - Settings Screen

With the Water Fault turned ON, the water flow will be monitored during welding. If it's determined that water is not flowing, the weld will be terminated and a message will be displayed indicating a Water Fault.

If the Gas Fault is turned ON, gas flow level will be monitored during welding and compared to the required flow level. If the monitored flow level is less than the required level, the weld will be terminated and a message will be displayed indicating a Gas Fault.

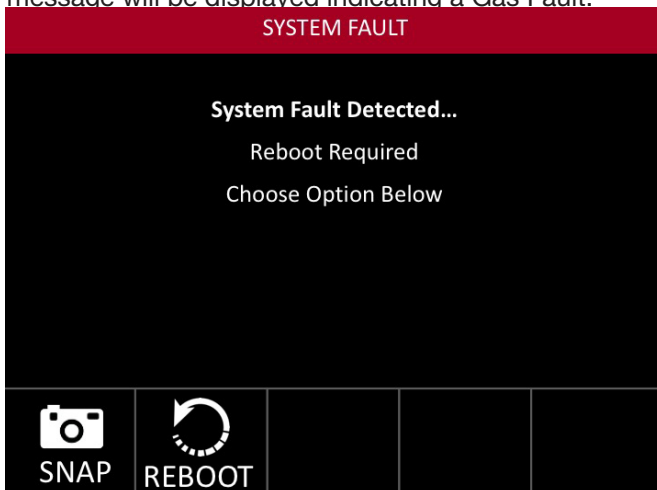

FIGURE 38 - Snapshot System Fault

If the Gas and Water Faults are turned OFF as shown in **FIGURE 36 - Faults Screen Off Settings** – welding will continue regardless of the level of gas or water flow. If the appropriate flow sensor hardware is not present in the system then the corresponding fault(s) should be disabled.

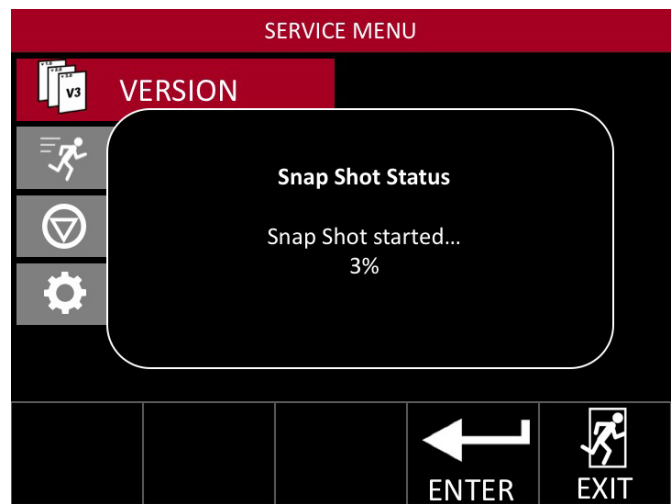

FIGURE 39 - Snapshot Status Screen

Settings

The Settings Menu shown in **FIGURE 37- Settings Screen** – provides access to the Production Monitoring feature. When enabled, it will automatically archive a summary of each weld to an inserted USB drive. Use the Right Toggle to turn this feature ON/OFF.

How To Take A Snapshot

If a USB drive is inserted into the APEX 30M, APEX 30S or APEX 3000, the Pendant will allow a snapshot to be taken from the screens shown in **FIGURE 31**, **FIGURE 32**, and **FIGURE 38**. A snapshot provides detailed information concerning the systems current configuration and the status and is initiated by pushing the SNAP Selection button.

The snapshot process may take several minutes to complete during which time a status screen like the one shown in **FIGURE 39 - Snapshot Status Screen** is presented.

Users

The Users Screen shown in **FIGURE 40 - Users Screen** – allows the user to set up operator and administrator log in codes. Each user can be assigned an individual code which determines the level of access.

Fast Movement

Using the steering knob, Fast Movement is enabled on this screen. In addition, use the steering knob or the left and right toggles for navigation and selection.

Adding Users

Only those with supervisor access are able to view the users screen.

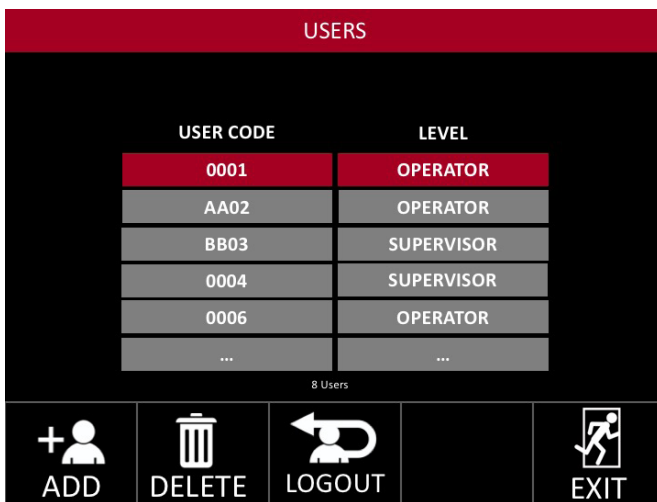

FIGURE 40 - Users Screen



Press the Add User Selection button. As demonstrated in **FIGURE 41 - Add User**, pressing the Add Selection button will bring up the Add User screen.

Note: Toggle switches do not work on the Add User Screen – only the steering knob.

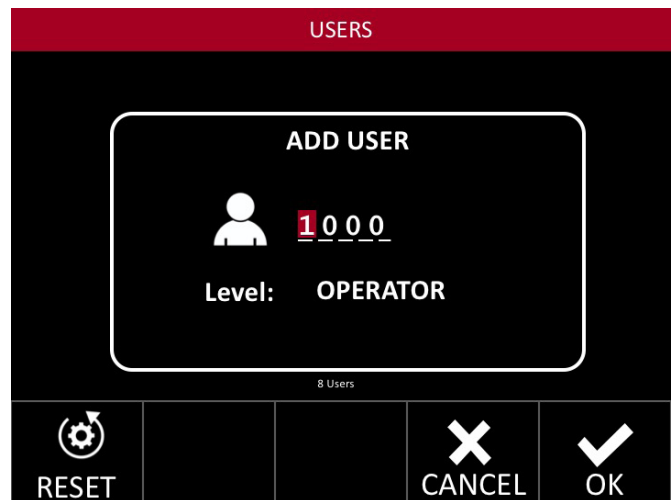

FIGURE 41 - Add User

Once the code has been selected, the supervisor can determine the user's level of access.

Operator

The operator has no access to the settings and will only be able to operate within the parameters placed by the supervisor for each program.

Supervisor

The supervisor has full rights and access to all welding parameters and setup screens.

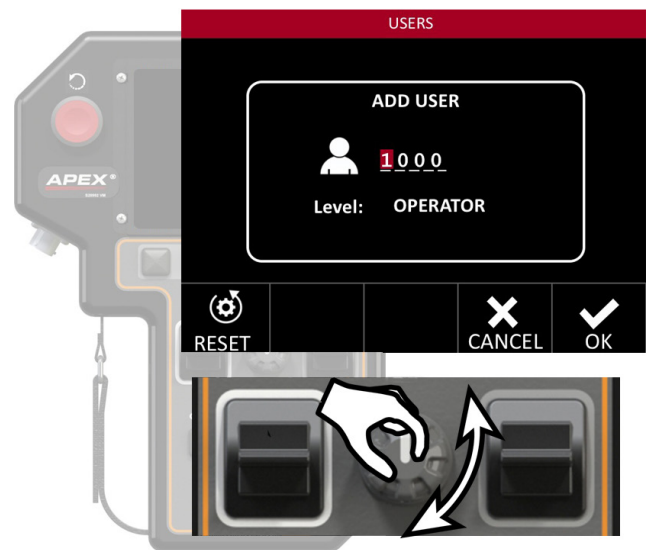

Changes the value of the selected item

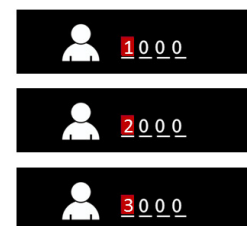

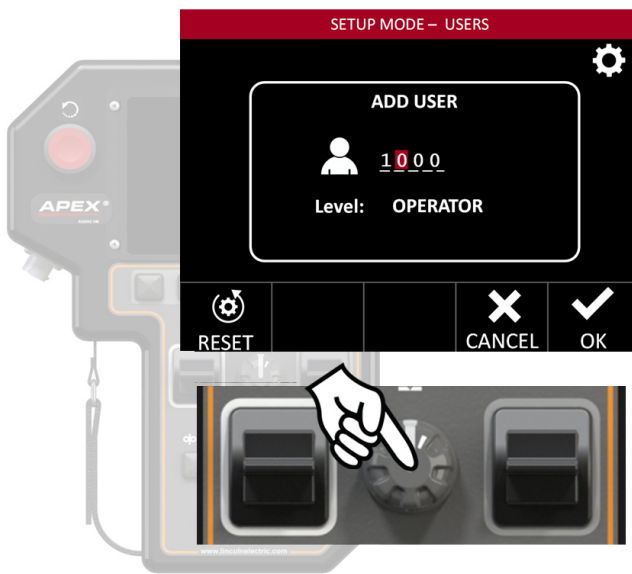

Changes the location of the cursor

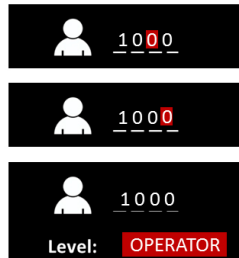

Once you have chosen the appropriate User code and level of access, select OK. Reset will change characters back to “0000”.

Deleting Users

Press the Delete Selection Button after selecting a user from the list.



Deleting a user account will bring up a warning screen. Press the Detail Selection button to see more information about the shown screen.

CAUTION: DELETING ALL SUPERVISORS WILL REQUIRE A FACTORY RESET. PLEASE CONTACT THE FACTORY FOR INSTRUCTIONS.

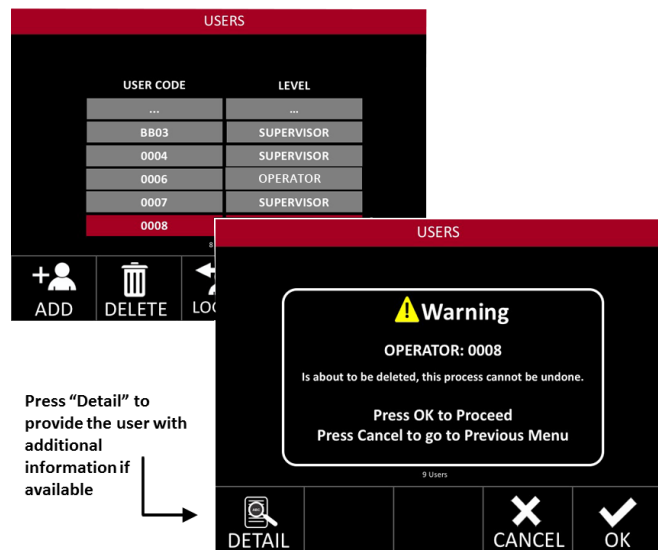

Press “Detail” to provide the user with additional information if available

The warning screen allows the user the chance to re-view what is being deleted. The warning screen shows the level of access and the user code. In this instance it is USER: 0008. If this User Code had Supervisory access the screen would read, SUPERVISOR: 0008.

If there are too many users to fit on the screen the last box will contain ellipses, see **FIGURE 42 - Multiple Users**. This indicates that there are additional system users. At the bottom of the fields it will tell how many user codes are currently listed in the system.

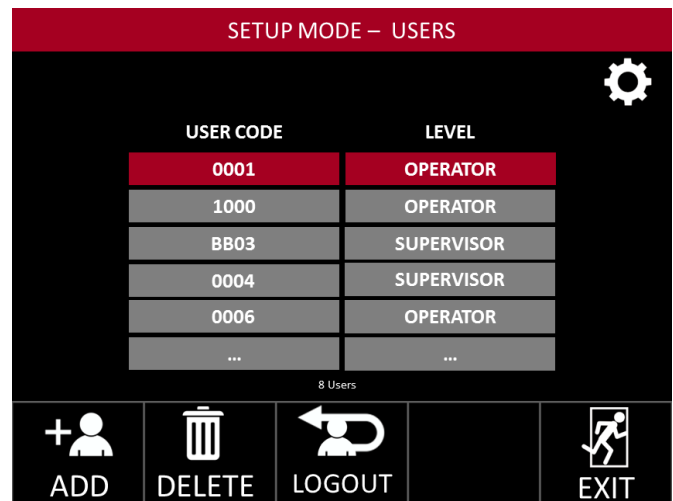

FIGURE 42 - Multiple Users

Changing User Access

To change the level of access that a user has been granted, press the ADD selection button. Instead of entering a unique user code, add in the existing user code that needs to be changed. With “Level” highlighted choose the new access level.

Log Out

To change users, press the Logout Selection button. This logs out the current user so that a new user can log in.



Note: If the new user code is set as an operator they may not have full access to the system settings. Be sure to always have at least one supervisor code at all times for full system access.

Operator Log In

When an operator logs into the pendant they are presented with the program screen – see **FIGURE 43 - Operator Log In**.

Since operators cannot save, delete, or create programs, they are presented with the program options available to them. They can select only these programs.

When entering setup mode, operators are automatically brought to the Programs Screen.

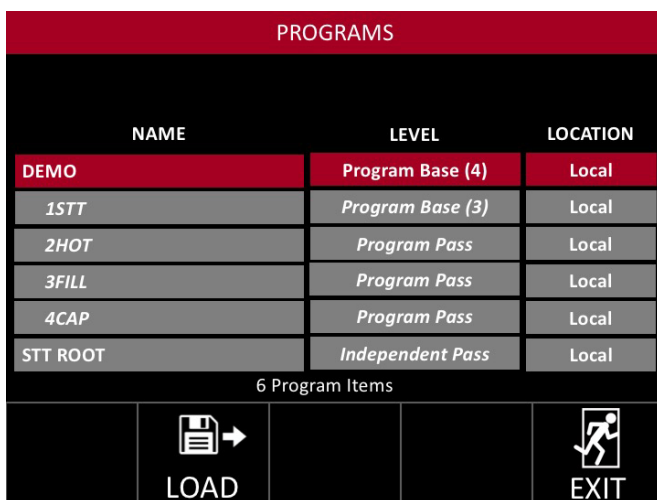

FIGURE 43 - Operator Log In

Increments Settings

The increments screen, see **FIGURE 44 - Increments Screen** is used to set how much a single button press will change each value and limit the operator’s access to certain parameters.

The minimum and maximum values provided to the user are based on welding power source, weld mode and other items.

The **increments options** that can be set are:

- Wire Feed Speed
- Voltage or Trim (depending on the weld mode)
- Amperage
- Travel Speed
- Oscillation Width
- Oscillation Speed
- Dwell Time

Each of these values can have a minimum and maximum value set that the operator will not be able to exceed. These increments can be changed per program and per pass.

To reset all increments back to their widest tolerance press the Reset Selection button.

Operator limitations also include the ability to set the system units between Imperial to Metric, which can only be performed by a supervisor.

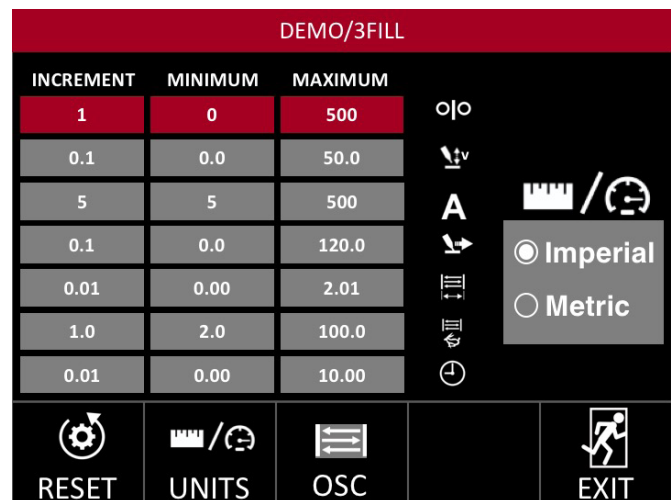

FIGURE 44 - Increments Screen

See the **Increments Reference** on page A-44 for a complete list of the different values for imperial and metric measurements. If a multipass program is loaded, pressing the sector button will advance to the next pass. This allows the user to quickly set the limits and increments for each pass.

SETUP SCREEN	VALUE NAME	IMPERIAL INCREMENTS	METRIC INCREMENTS																								
<p>DEMO/3FILL</p> <table border="1"> <thead> <tr> <th>INCREMENT</th> <th>MINIMUM</th> <th>MAXIMUM</th> </tr> </thead> <tbody> <tr> <td>1</td> <td>75</td> <td>680</td> </tr> <tr> <td>0.01</td> <td>0.50</td> <td>1.50</td> </tr> <tr> <td>0.1</td> <td>0.0</td> <td>500.0</td> </tr> <tr> <td>0.1</td> <td>0.0</td> <td>100.0</td> </tr> <tr> <td>0.01</td> <td>0.01</td> <td>2.04</td> </tr> <tr> <td>0.1</td> <td>2.0</td> <td>100.0</td> </tr> <tr> <td>0.01</td> <td>0.00</td> <td>10.00</td> </tr> </tbody> </table> <p>RESET UNITS EXIT</p>	INCREMENT	MINIMUM	MAXIMUM	1	75	680	0.01	0.50	1.50	0.1	0.0	500.0	0.1	0.0	100.0	0.01	0.01	2.04	0.1	2.0	100.0	0.01	0.00	10.00	<p>INCREMENTS & LIMITS MENU</p> <ul style="list-style-type: none"> Wire Speed Voltage Amperage Travel Speed Oscillation Width Oscillation Speed Oscillation Dwell 	<p>ipm Volts Amps ipm inches ipm seconds</p>	<p>cm/min Volts Amps cm/min centimeters cm/min seconds</p>
INCREMENT	MINIMUM	MAXIMUM																									
1	75	680																									
0.01	0.50	1.50																									
0.1	0.0	500.0																									
0.1	0.0	100.0																									
0.01	0.01	2.04																									
0.1	2.0	100.0																									
0.01	0.00	10.00																									
<p>START SETTINGS</p> <table border="1"> <tbody> <tr> <td>1.0</td> <td>PREFLOW</td> </tr> <tr> <td>1.5</td> <td>UPSLOPE</td> </tr> <tr> <td>200</td> <td>RUNIN WFS</td> </tr> <tr> <td>15.0</td> <td>RUNIN VOLTS</td> </tr> <tr> <td>1.5</td> <td>MOTION DELAY</td> </tr> </tbody> </table> <p>ADV EXIT</p>	1.0	PREFLOW	1.5	UPSLOPE	200	RUNIN WFS	15.0	RUNIN VOLTS	1.5	MOTION DELAY	<p>START SETTINGS MENU</p> <ul style="list-style-type: none"> Preflow Upslope Runin Wire Feed Speed Runin Voltage Motion Delay 	<p>seconds seconds ipm Volts seconds</p>	<p>seconds seconds cm/min Volts seconds</p>														
1.0	PREFLOW																										
1.5	UPSLOPE																										
200	RUNIN WFS																										
15.0	RUNIN VOLTS																										
1.5	MOTION DELAY																										
<p>END SETTINGS</p> <table border="1"> <tbody> <tr> <td>80</td> <td>CRATER WFS</td> </tr> <tr> <td>10.0</td> <td>CRATER VOLTS</td> </tr> <tr> <td>0.04</td> <td>CRATER TIME</td> </tr> <tr> <td>0.20</td> <td>BURNBACK</td> </tr> <tr> <td>1.0</td> <td>DOWNSLOPE</td> </tr> <tr> <td>1.0</td> <td>POSTFLOW</td> </tr> </tbody> </table> <p>ADV EXIT</p>	80	CRATER WFS	10.0	CRATER VOLTS	0.04	CRATER TIME	0.20	BURNBACK	1.0	DOWNSLOPE	1.0	POSTFLOW	<p>END SETTINGS MENU</p> <ul style="list-style-type: none"> Crater Wire Feed Speed Crater Voltage Crater Time Burnback Downslope Postflow 	<p>ipm Volts seconds seconds seconds seconds</p>	<p>cm/min Volts seconds seconds seconds seconds</p>												
80	CRATER WFS																										
10.0	CRATER VOLTS																										
0.04	CRATER TIME																										
0.20	BURNBACK																										
1.0	DOWNSLOPE																										
1.0	POSTFLOW																										
<p>PROCESS SETUP</p> <table border="1"> <tbody> <tr> <td>2</td> <td>MODE 18</td> </tr> <tr> <td>Yes</td> <td>Pulse</td> </tr> <tr> <td>125</td> <td>0.045</td> </tr> <tr> <td>1.10</td> <td>Steel</td> </tr> <tr> <td>90</td> <td>CO2/AR</td> </tr> <tr> <td>5.0</td> <td></td> </tr> </tbody> </table> <p>MODE ADV EXIT</p>	2	MODE 18	Yes	Pulse	125	0.045	1.10	Steel	90	CO2/AR	5.0		<p>PROCESS SETUP MENU</p> <ul style="list-style-type: none"> Wire Feed Speed Voltage Amperage Travel Speed 	<p>ipm Volts Amps ipm</p>	<p>cm/in Volts Amps cm/min</p>												
2	MODE 18																										
Yes	Pulse																										
125	0.045																										
1.10	Steel																										
90	CO2/AR																										
5.0																											
<p>PROCESS SETUP</p> <table border="1"> <tbody> <tr> <td>2</td> <td>MODE 18</td> </tr> <tr> <td>Yes</td> <td>Pulse</td> </tr> <tr> <td>125</td> <td>0.045</td> </tr> <tr> <td>1.10</td> <td>Steel</td> </tr> <tr> <td>90</td> <td>CO2/AR</td> </tr> <tr> <td>5.0</td> <td></td> </tr> <tr> <td>0.22</td> <td></td> </tr> <tr> <td>55.0</td> <td></td> </tr> <tr> <td>0.40</td> <td></td> </tr> <tr> <td>0.40</td> <td></td> </tr> </tbody> </table> <p>MODE ADV EXIT</p>	2	MODE 18	Yes	Pulse	125	0.045	1.10	Steel	90	CO2/AR	5.0		0.22		55.0		0.40		0.40		<p>PROCESS SETUP MENU</p> <ul style="list-style-type: none"> Oscillation Width Oscillation Speed Left Dwell Right Dwell 	<p>inches ipm seconds seconds</p>	<p>centimeters cm/min seconds seconds</p>				
2	MODE 18																										
Yes	Pulse																										
125	0.045																										
1.10	Steel																										
90	CO2/AR																										
5.0																											
0.22																											
55.0																											
0.40																											
0.40																											

Programs

From the Program Screen – see **FIGURE 45- Programs Screen** – programs can be saved into the system or onto a USB memory stick.

Fast Movement

Fast movement using the steering knob is enabled on this screen. Use the steering knob or left and right toggles for navigation and selection.

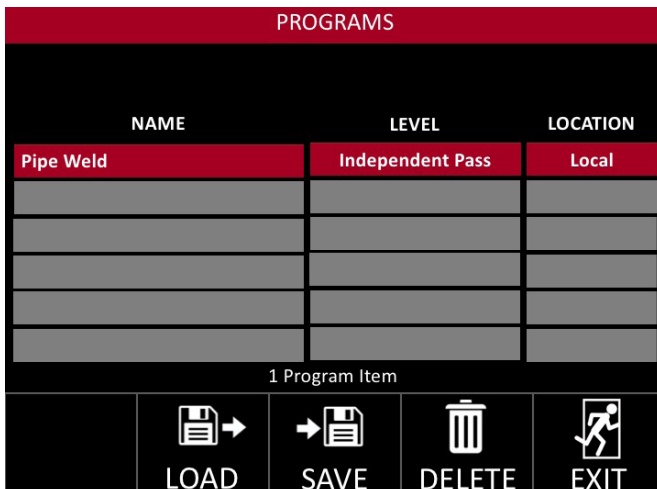

FIGURE 45 - Programs Screen

Saving an Independent Pass

A supervisor can change the parameters of the loaded program. Once the parameters are changed, they can be saved as a new program.

Pressing the save selection button will take the user to a sub-menu. This menu will allow the user to program the following variables:

Location: Selects where the program is saved

- Local: This saves directly to the Pendant
- USB: This saves to the installed USB. This option only appears when a USB is plugged in.

Level: Selects what type of Program is being saved

- Independent Pass - stand alone weld procedures, not tied to any other program
- Program Base - The first step in creating multiple passes which tie together to form a full welding procedure; this is explained in the next section.
- Program Pass - These are tied to the Program Base and can be created as needed by the user. For example a pipe could require four passes, so each pass could be saved under a Program Base for easy retrieval.

Pass Name: Allows the user to select a unique pass name to identify the pass or program.

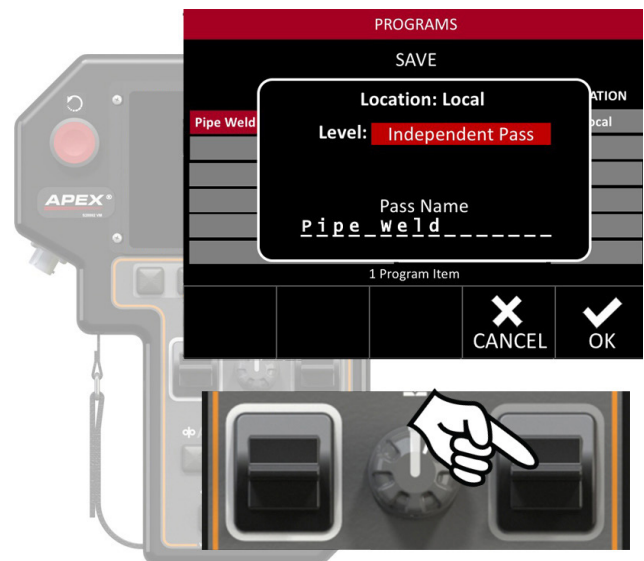

Switches between Program Base & Independent Pass

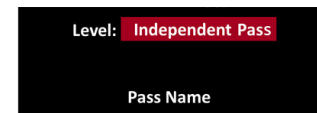

Once the location and level are set, choose a unique name for the program. This name should be distinct to prevent confusion.

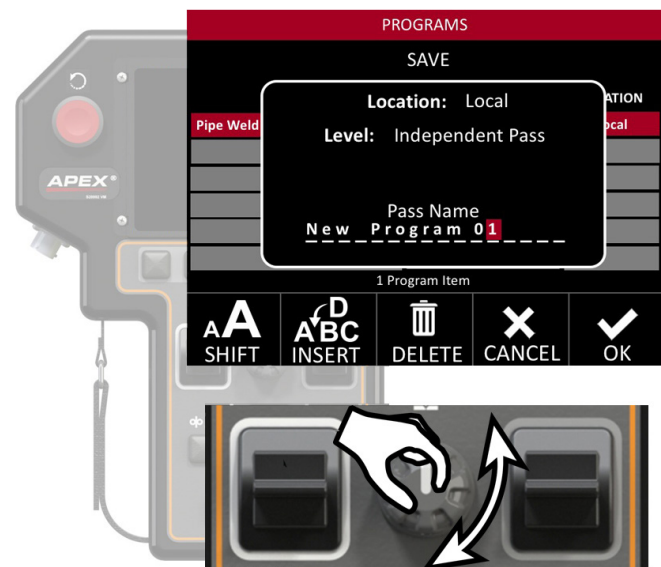

The name field always auto populates with the name for the currently loaded program or the program name selected when the save button was pushed. Change this independent pass to “New Program 01” and press the OK Selection button.

Note: Saving to a USB limits the program to 8 characters.

A new independent pass is created with the selected name.

PROGRAMS		
Program Save Succeeded		
NAME	LEVEL	LOCATION
New Program 01	Independent Pass	Local
Pipe Weld	Independent Pass	Local
2 Program Items		
LOAD	SAVE	DELETE
		EXIT

Saving a Program Base

If there are multiple passes on the same material, setting up a Program Base is recommended. In the save program sub-menu, change the level from Independent Pass to Program Base.

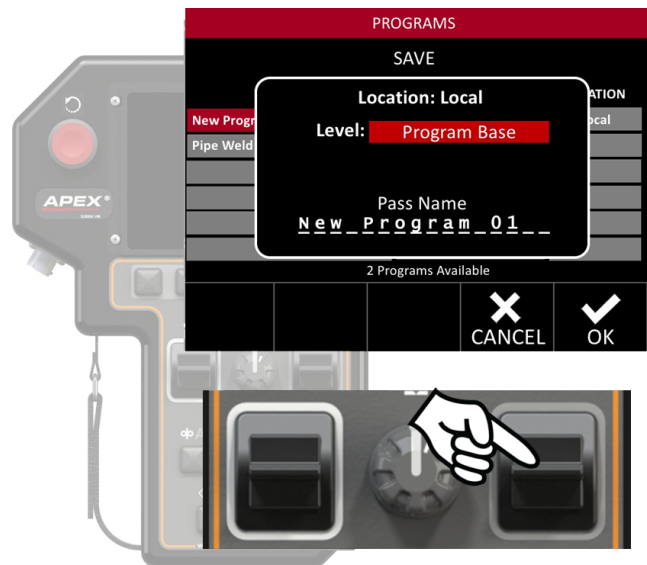

Switches between Program Base & Independent Pass

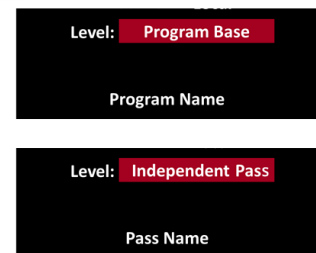

PROGRAMS		
Program Root Saved		
NAME	LEVEL	LOCATION
New Program 01	Independent Pass	LOCAL
Pipe Weld	Independent Pass	LOCAL
Steel 2in Pipe	Program Base(0)	LOCAL
3 Programs Available		
LOAD	SAVE	DELETE
		EXIT

Saving a Program Pass

Once a program base is saved, the next step is to create individual passes within the Program Base for the settings to be saved.

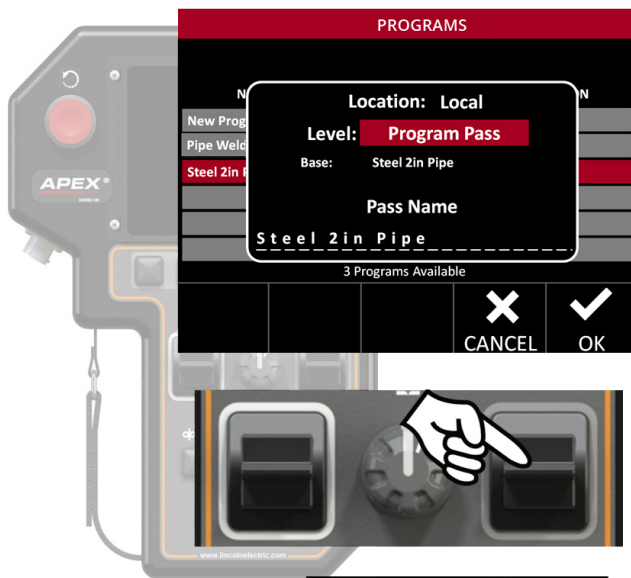

Switches between Independent Pass, Program Base, Program Pass and Program Update

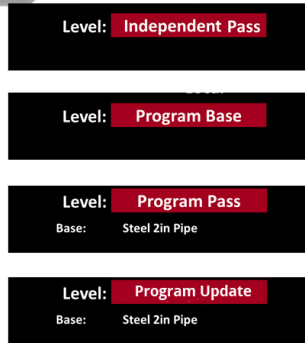

For this example the pass has been named 1Root. Continue to save programs to this base until the required passes are all saved.

After saving the required passes they are all displayed under the base – see **FIGURE 46 – Full Program Base**.

Saving Program Updates

A fourth level selection is available when changes are made to Program Passes associated with a Program Base.

PROGRAMS		
Program Save Succeeded		
NAME	LEVEL	LOCATION
New Program 01	Independent Pass	LOCAL
Pipe Weld	Independent Pass	LOCAL
Steel 2in Pipe	Program Base(1)	LOCAL
1Root	Program Pass	LOCAL
4 Programs Available		
LOAD	SAVE	DELETE
EXIT		

PROGRAMS		
Program Save Succeeded		
NAME	LEVEL	LOCATION
New Program 01	Independent Pass	LOCAL
Pipe Weld	Independent Pass	LOCAL
Steel 2in Pipe	Program Base(3)	LOCAL
1Root	Program Pass	LOCAL
2Fill	Program Pass	LOCAL
3Cap	Program Pass	LOCAL
6 Programs Available		
COPY	LOAD	SAVE
DELETE		
EXIT		

FIGURE 46 - Full Program Base

When changes have been made to one or more Program Passes and the Program Base containing the changed Program Passes is selected and the SAVE button is pressed, the Program Update option becomes available on the SAVE screen.

If changes were made to one or all of the Program Passes associated with the Program Base “Steel 2in Pipe”, selecting the Program Base and pressing the SAVE button would product the following screen:

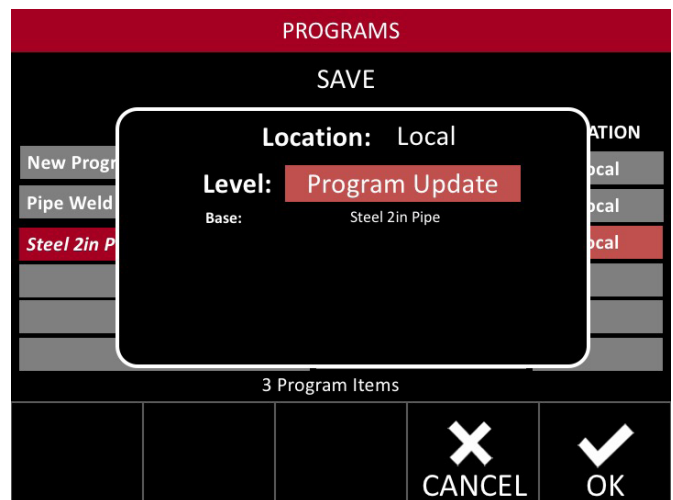

Selecting Program Update and pressing the OK button on this screen will save the changes made to all Program Passes at one time rather than requiring each Program Pass to be saved separately.

Hide Program Passes

The passes in a program base can be hidden by highlighting the program base and pressing the steering knob, collapsing the group. Press the steering knob again and it will re-expand.

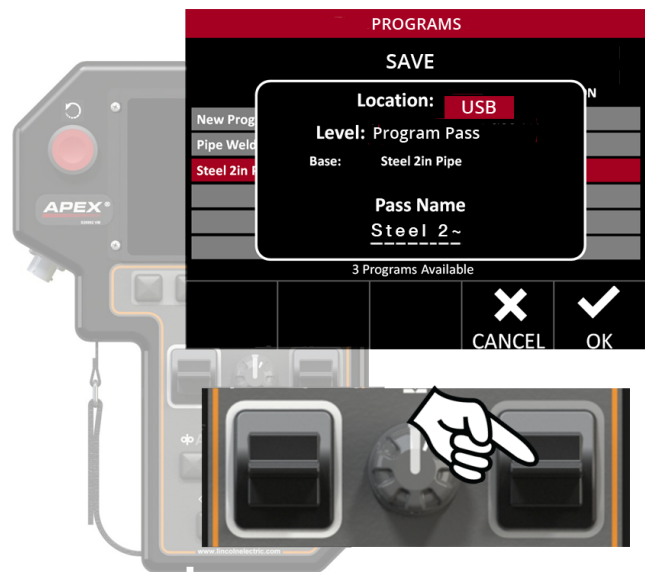
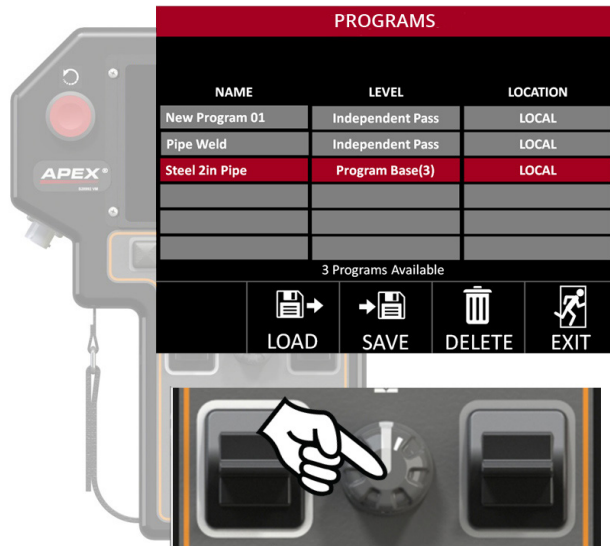

Switches between USB & Local

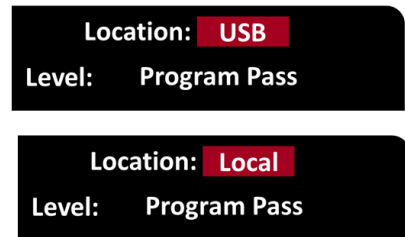

Saving to a USB

All of the examples shown have been saved locally to the pendant. They can also be saved to a USB.

The USB has a folder set up specifically to save or read files. If this folder is missing then a prompt will appear on the screen – see **FIGURE 47 - USB Folder Notification**.

To access files already saved on the USB, move them to the specified directory.

Note: A USB file name is restricted to 8 characters. Local files can be up to 16 characters. The only program name blocked is "Lincoln".



FIGURE 47 - USB Folder Notification

If the flash drive is new, the system will create a folder once the pendant operator presses "Ok".

Copy to/from USB

With the USB inserted, a Copy Icon appears in the bottom left of the screen - see **FIGURE 48 - Copy Icon**.

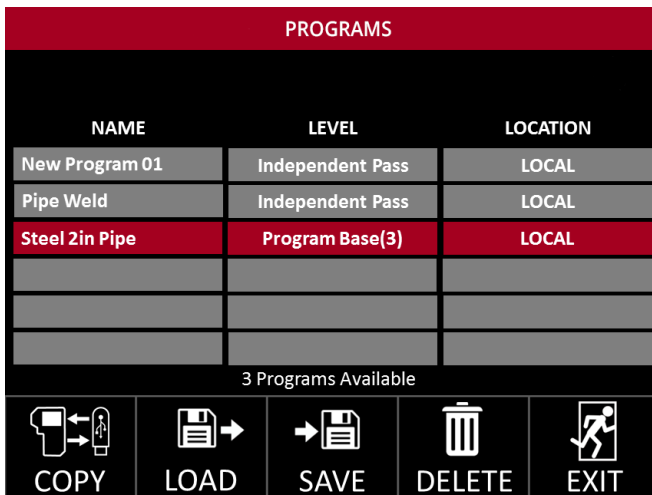

FIGURE 48 - Copy Icon

Press the Copy Selection Button. A copy of the selected program is made – see **FIGURE 49 - Copy to USB**

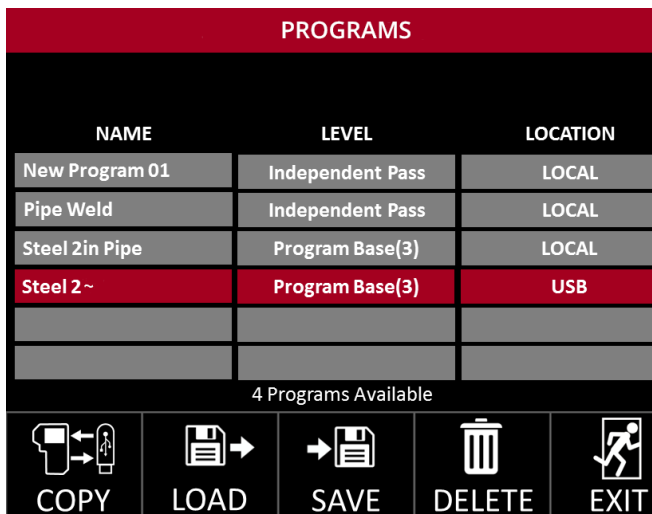

FIGURE 49 - Copy to USB

If the file is currently saved on the USB, it will save to the Pendant, if it is a Local file (saved to the Pendant), it will save to USB.

Note: If a locally saved program has more than 8 characters (including spaces), copying to a USB will truncate it to the first 8 characters of the original name, as shown in **FIGURE 48 - Copy to USB**. To save with a unique name, load the program and then manually save to the USB with the desired 8-character name.

Deleting a Program

Saved programs can be deleted by highlighting the program and pressing the Delete Selection button.

This will bring up a new window – see **FIGURE 50 - Program Delete**. Press the Delete Selection Butto

Deleting a Program Base

If a Program Base is deleted then all associated passes are also deleted.

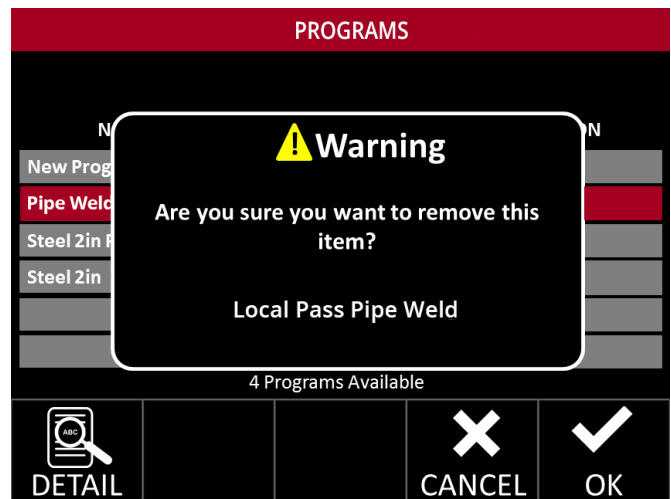

FIGURE 50 - Program Delete

PROGRAMS		
NAME	LEVEL	LOCATION
New Program 01	Independent Pass	LOCAL
Pipe Weld	Independent Pass	LOCAL
Steel 2in Pipe	Program Base(3)	LOCAL
3 Programs Available		
COPY	LOAD	SAVE
DELETE	EXIT	

FIGURE 51 - Loading Program

Loading a Program

Go to the Programs Menu to load the relevant program. Highlight the program or base.

Press the Load Selection button. This will load the applicable program. See **FIGURE 51 - Loading Program** and **FIGURE 52 - Loaded Program**.

Overwriting a Program

Saving a file with the same name will overwrite the existing program. The system gives a warning that the existing program will be overwritten. Overwriting it will delete the original program.

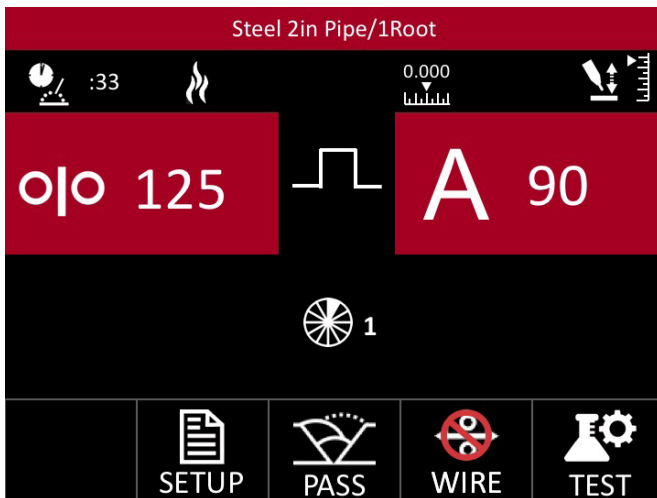
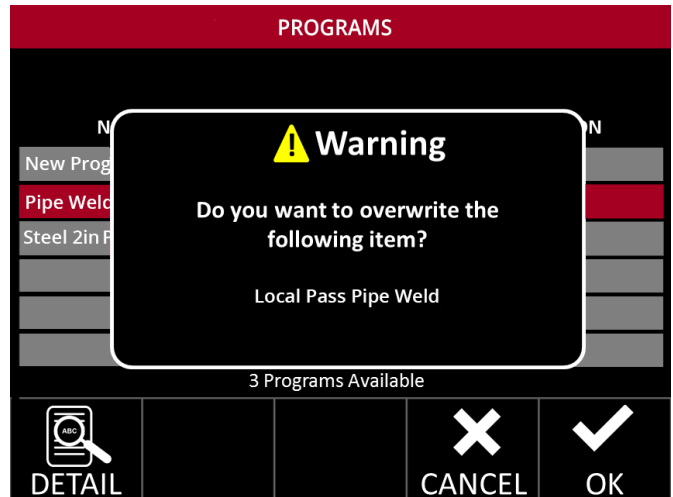
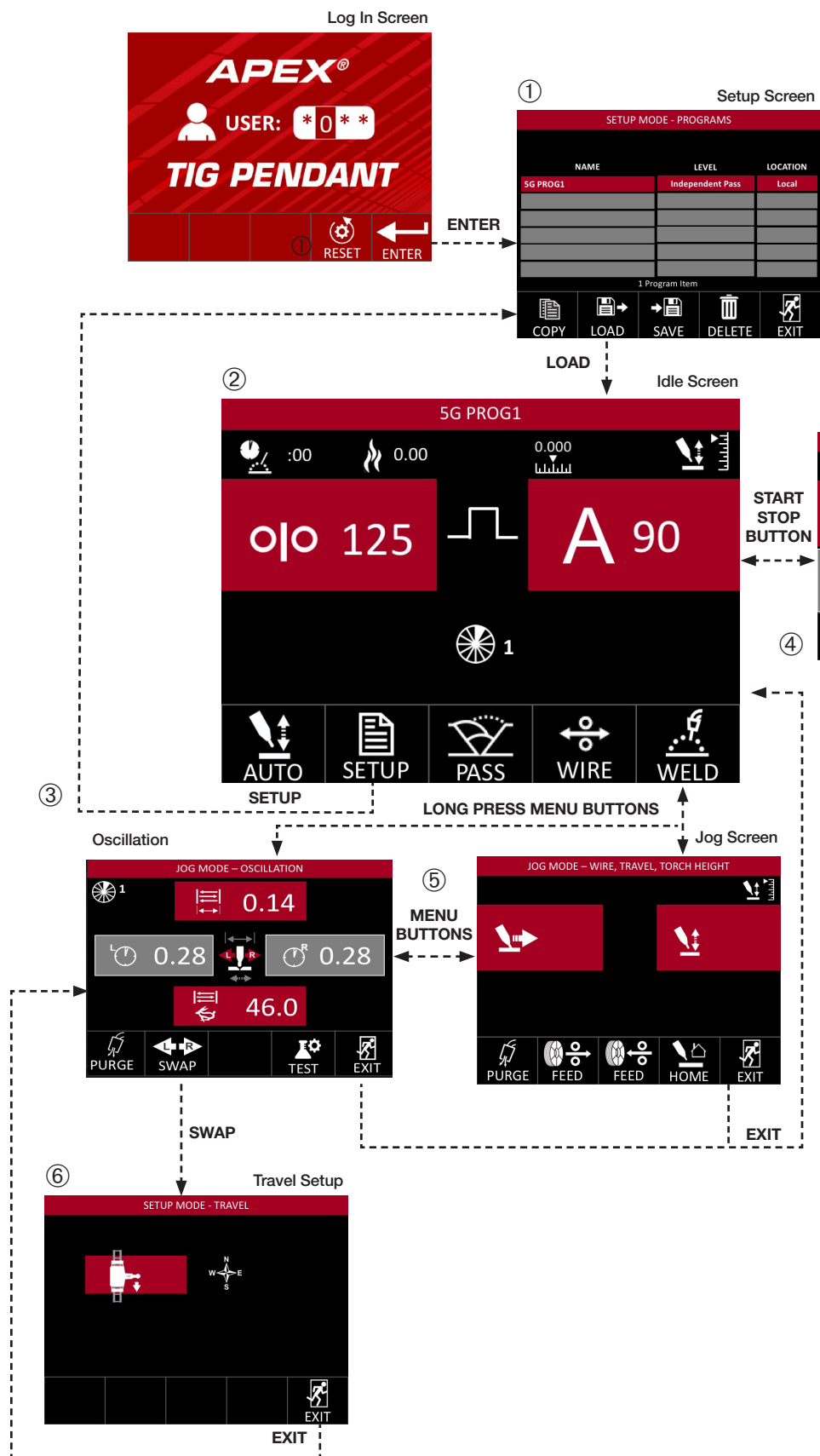

FIGURE 52 - Loaded Program

Operator Navigation Chart



OPERATOR VIEWS

Supervisors will have access to all levels of the system, however the system is designed to lock out operators from higher level functions at the supervisor's discretion.

Operators have access to a limited number of screens. The following flow chart provides a reference of all the screens available, how to get to them and navigate back.

1. After logging in the operator can choose any existing program to load.

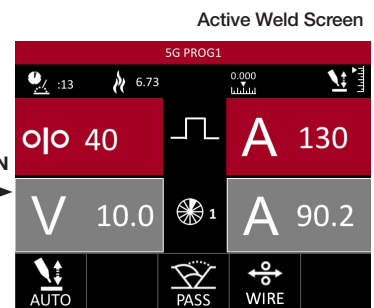

2. The loaded program will move into the Idle Screen in test mode.
3. Return to the Setup Screen by pressing the Setup Selection button.
4. Move into Active Test to verify all weld settings, or Active Weld to begin welding.
5. From the Idle Screen long pressing the menu buttons will take the operator to the corresponding Jog or Oscillation Menu. Use the menu buttons to switch between the two menus.
6. It may be necessary to change the weld head orientation. This allows the user to set how the weld head steers and operates in relation to their position.

Pressing EXIT from any screen will return the operator to the previous menu.

Refer to this Operator's Manual for more detailed operating instructions.

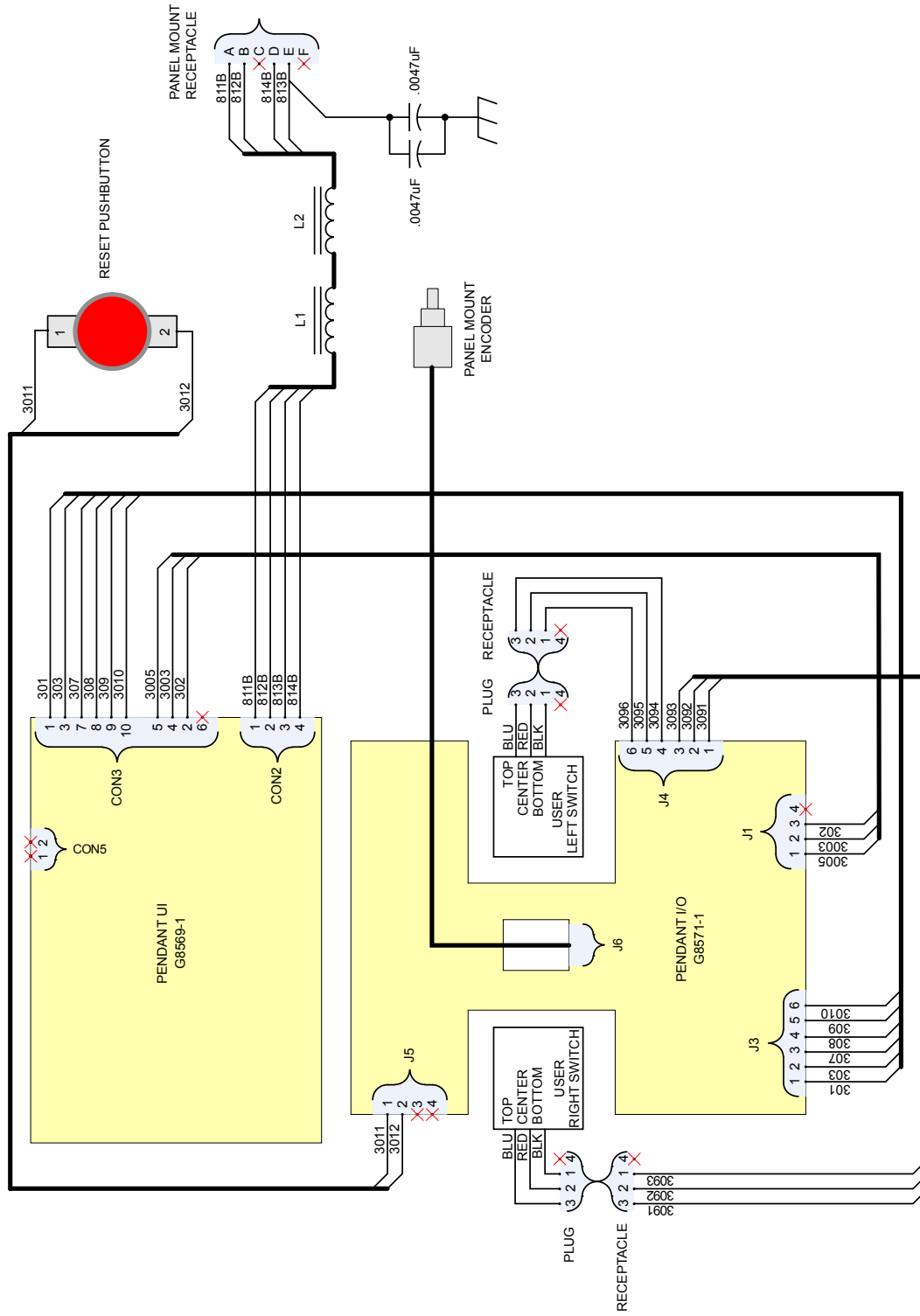

NOTE: This diagram is for reference only. It may not be accurate for all machines covered by this manual. The specific diagram for a particular code is pasted inside the machine on one of the enclosure panels. If the diagram is illegible, write to the Service Department for a replacement. Give the equipment code number.

S33197 Rev. A

GTAW Timing Diagram

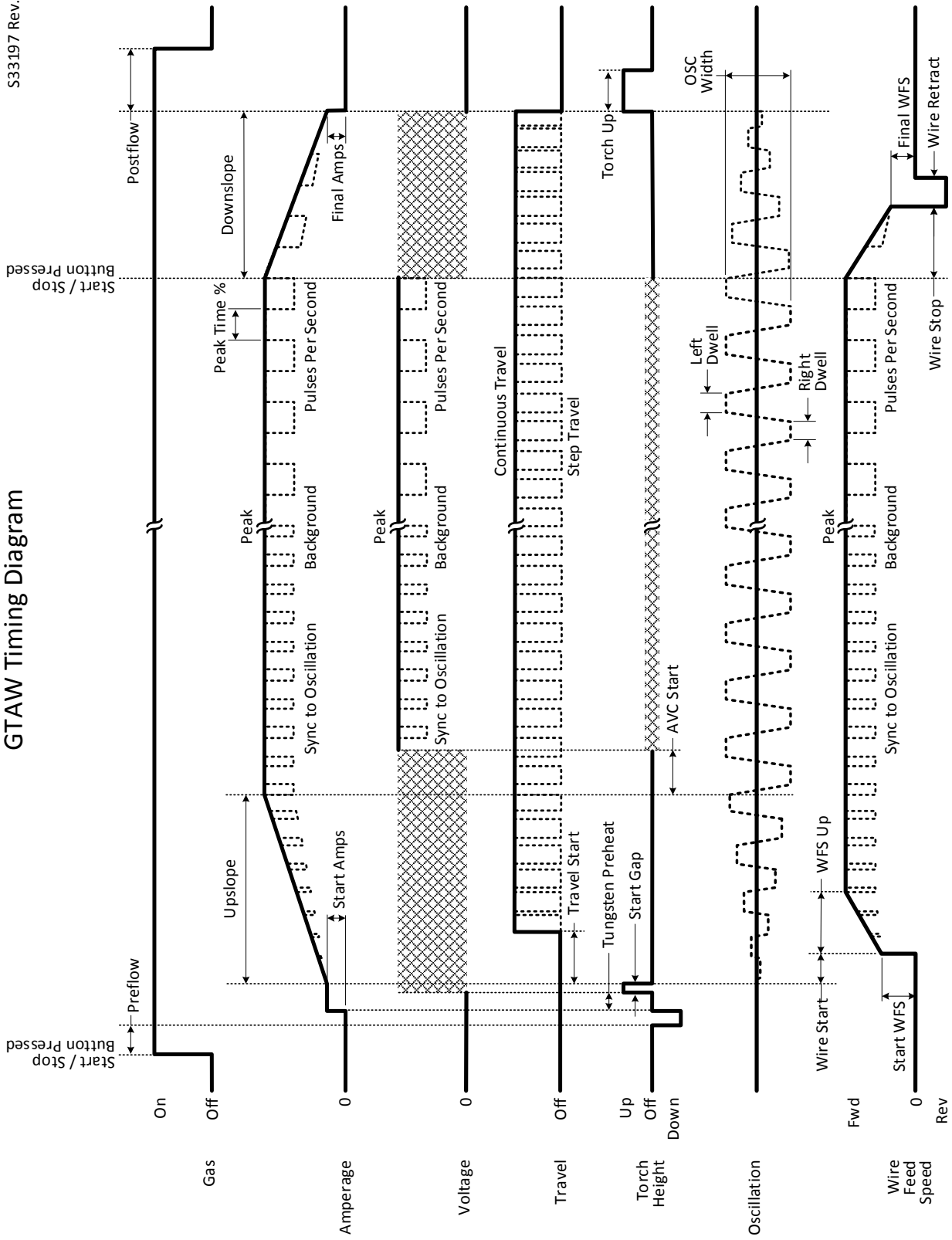

STANDARD PIPING SCHEDULE CHART

OD in	OD mm	Schedule	Wall in	Wall mm	ID in	ID mm
1/8 0.405	10.3	10S	0.049	1.24	0.307	7.8
		40ST, 40S	0.068	1.73	0.269	6.83
		80SX, 80S	0.095	2.41	0.215	5.46
1/4 0.54	13.7	10S	0.065	1.65	0.41	10.41
		40ST, 40S	0.088	2.24	0.364	9.25
		80SX, 80S	0.119	3.02	0.302	7.67
3/8 0.675	17.1	10S	0.065	1.65	0.545	13.84
		40ST, 40S	0.091	2.31	0.493	12.52
		80SX, 80S	0.126	3.2	0.423	10.74
1/2 0.84	21.3	5S	0.065	1.65	0.71	18.03
		10S	0.083	2.11	0.674	17.12
		40ST, 40S	0.109	2.77	0.622	15.8
3/4 1.05	26.7	10S	0.083	2.11	0.884	22.45
		40ST, 40S	0.113	2.87	0.824	20.93
		80SX, 80S	0.154	3.91	0.742	18.85
1 1.315	33.4	10S	0.083	2.11	1.094	27.8
		40ST, 40S	0.113	2.87	1.034	26.28
		80SX, 80S	0.154	3.91	0.952	24.31
1 1/4 1.66	42.2	5S	0.065	1.65	1.185	30.1
		10S	0.083	2.11	1.097	27.86
		40ST, 40S	0.109	2.77	1.045	26.64
1 1/2 1.9	48.3	5S	0.065	1.65	1.377	34.9
		10S	0.083	2.11	1.289	32.64
		40ST, 40S	0.109	2.77	1.237	31.42
2 2.375	60.3	5S	0.065	1.65	1.569	39.9
		10S	0.083	2.11	1.481	37.64
		40ST, 40S	0.109	2.77	1.429	36.42
2 1/2 2.875	73	5S	0.065	1.65	1.761	44.9
		10S	0.083	2.11	1.673	42.64
		40ST, 40S	0.109	2.77	1.621	41.42
3 3.5	88.9	5S	0.065	1.65	1.953	49.9
		10S	0.083	2.11	1.865	47.64
		40ST, 40S	0.109	2.77	1.813	46.42
3 1/2 4	101.6	5S	0.065	1.65	2.145	54.9
		10S	0.083	2.11	2.057	52.64
		40ST, 40S	0.109	2.77	2.005	51.42
4 4.5	114.3	5S	0.065	1.65	2.337	60.9
		10S	0.083	2.11	2.249	58.64
		40ST, 40S	0.109	2.77	2.197	57.42
5 5.563	141.3	5S	0.065	1.65	2.529	64.9
		10S	0.083	2.11	2.441	62.64
		40ST, 40S	0.109	2.77	2.389	61.42
6 6.625	168.3	5S	0.065	1.65	2.721	69.9
		10S	0.083	2.11	2.633	67.64
		40ST, 40S	0.109	2.77	2.581	66.42
8 8.625	219.1	5S	0.065	1.65	2.913	74.9
		10S	0.083	2.11	2.825	72.64
		40ST, 40S	0.109	2.77	2.773	71.42

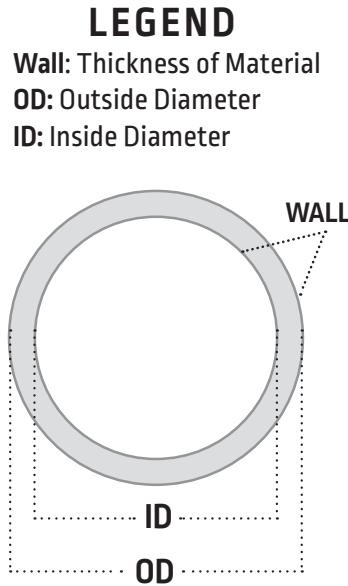

OD in	OD mm	Schedule	Wall in	Wall mm	ID in	ID mm
10 10.75	273	5S	0.134	3.4	10.482	266.2
		10S	0.165	4.19	10.42	264.7
		20	0.25	6.35	10.25	260.4
		30	0.307	7.8	10.136	257.5
		40ST, 40S	0.365	9.27	10.02	254.5
		60XS, 80S	0.5	12.7	9.75	247.7
		80	0.594	15.09	9.562	242.9
		100	0.719	18.26	9.312	236.5
		120	0.844	21.44	9.062	230.2
		140, XX	1	25.4	8.75	222.3
160	1.12	28.58	8.5	215.9		
12	323.8	5S	0.156	3.96	12.438	315.9
		10S	0.188	4.807	12.39	314.7
		20	0.25	6.35	12.25	311.2
		30	0.33	8.38	12.09	307.1
		40	0.406	10.31	11.938	304.2
		5, 80S	0.5	12.7	11.75	298.5
		60	0.562	14.27	11.626	295.3
		80	0.688	17.48	11.374	288.9
		100	0.844	21.44	11.062	281
		120, XX	1	25.4	10.75	273.1
140	1.125	28.58	10.5	266.7		
160	1.312	33.32	10.126	257.2		
14	355.6	5S	0.156	3.96	13.688	347.7
		10S	0.188	4.78	13.624	346
		20	0.25	6.35	13.5	342.9
		30	0.312	7.92	13.376	339.8
		40, ST	0.375	9.53	13.25	336.6
		60	0.438	11.13	13.124	333.3
		80	0.5	12.7	13	330.2
		100	0.594	15.09	12.812	325.4
		120	0.719	18.26	12.562	319.0
		140	0.844	21.44	12.312	312.6
16	406.4	5S	0.165	4.19	15.67	398
		10S	0.188	4.78	15.624	396.8
		20	0.25	6.35	15.5	393.7
		30	0.312	7.92	15.376	390.6
		40, ST	0.375	9.53	15.25	387.4
		60	0.438	11.13	15	381
		80	0.5	12.7	14.888	373.1
		100	0.594	15.09	14.688	363.5
		120	0.719	18.26	14.438	354
		140	0.844	21.44	14.188	344.5
18	457	5S	0.165	4.19	17.67	449
		10S10	0.188	4.78	17.624	448
		20	0.25	6.35	17.5	445
		30	0.312	7.92	17.376	441
		40	0.375	9.53	17.25	438
		60	0.438	11.13	17.124	435
		80	0.5	12.7	17	432
		100	0.562	14.27	16.876	429
		120	0.688	17.48	16.626	422.9
		140	0.812	20.62	16.376	416.5
20	508	5S	0.188	4.78	19.624	498
		10S	0.218	5.54	19.564	497
		20	0.25	6.35	19.5	495
		30	0.375	9.53	19.25	489
		40, XS	0.5	12.7	19	483
		60	0.594	15.09	18.812	478
		80	0.719	18.26	18.562	471.5
		100	0.844	21.44	18.312	465.1
		120	1.031	26.19	17.938	456
		140	1.219	30.96	17.562	447.5
24	610	5S	0.218	5.54	23.564	599
		10, 10S	0.25	6.35	23.5	597
		20, ST	0.375	9.53	23.25	591
		30	0.5	12.7	23	584
		40	0.562	14.27	22.876	581
		60	0.688	17.48	22.624	575
		80	0.969	24.61	22.062	560
		100	1.218	30.96	21.562	548
		120	1.531	38.89	20.938	532
		140	1.812	46.02	20.376	518
30	762	5S	0.25	6.35	29.5	749
		10, 10S	0.312	7.92	29.376	746
		20, ST	0.375	9.53	29.25	743
		30, XS	0.5	12.7	29	737
		40	0.625	15.88	28.75	730



APEX® 3 SERIES TIG PENDANT PARTS

Code: 12834

This parts list is provided as an informative guide only.

APEX® 3 Series TIG Pendant

For Codes: 12834

Do not use this Parts List for a machine if its code number is not listed. Contact the Service Department for

Use the illustration of Sub-Assemblies page and the table below to determine which sub assembly page and column the desired part is located on for your particular code machine.

Sub Assembly Item Number	1	2	3	4	5	6	7
SUB ASSEMBLY PAGE NAME	APEX 3 Series Pendant						
PAGE NO.							
CODE NO.							
12834	1						

12-31-18

NOTE: This Parts Manual is provided as an informative guide only, when ordering parts always refer to the Lincoln Electric Parts List.

GENERAL ASSEMBLY

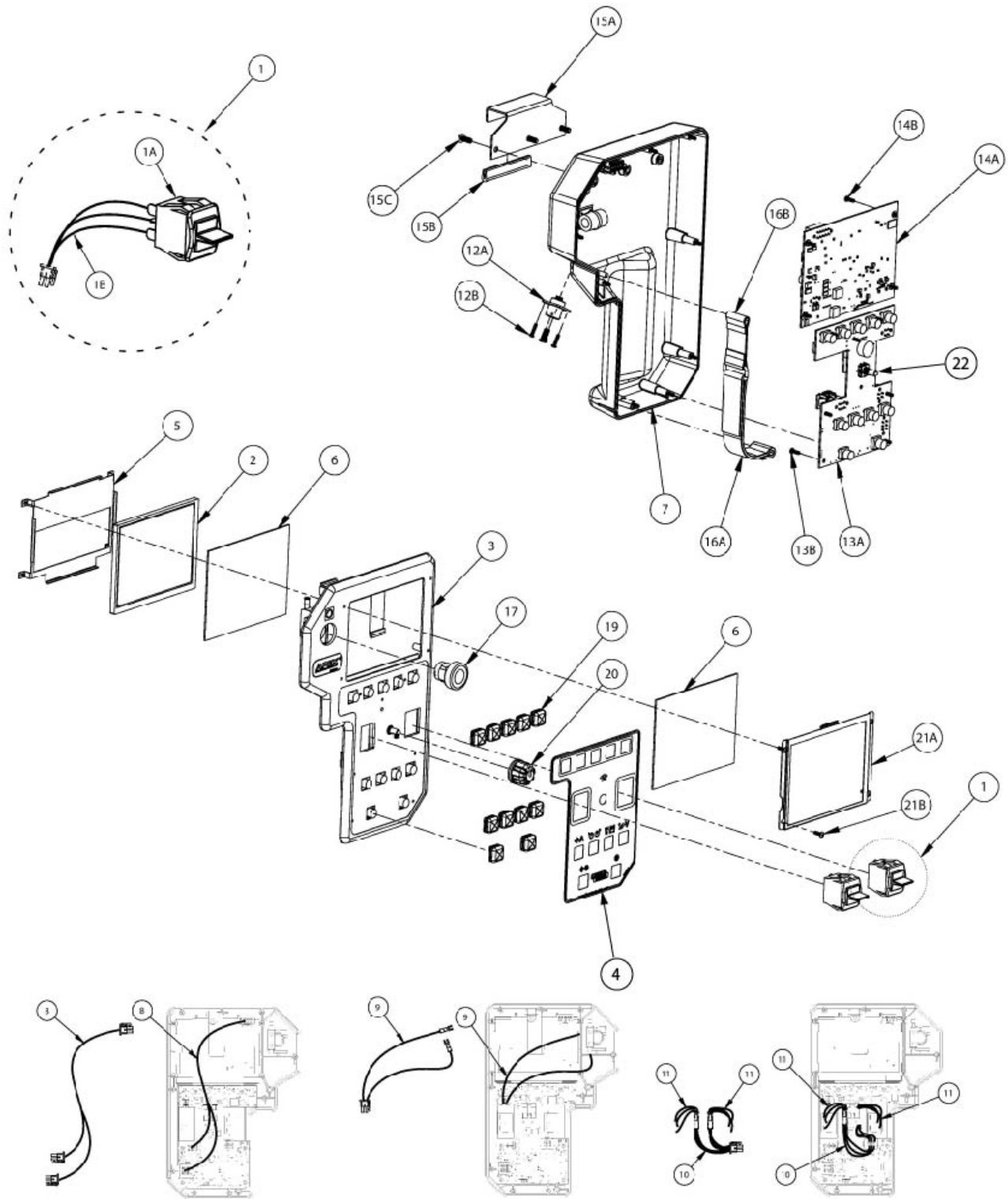

12-31-18

NOTE: This Parts Manual is provided as an informative guide only, when ordering parts always refer to the Lincoln Electric Parts List.

GENERAL ASSEMBLY

Use only the parts marked "x" in the column under

ITEM	DESCRIPTION	PART NO.	QTY	1
1	Rocker Switch & Harness Assembly, includes:	9SS30720	2	X
1A	Rocker Switch	9SS30493	2	X
1B	Harness Assembly	NSS	2	X
2	Color LCD	9SS29390	1	X
3	Pendant Top	9SM23062-2	1	X
4	Pendant Overlay	9SS30292	1	X
5	Screen Holder	9SM24594	1	X
6	Screen Protector	9SS30712	2	X
7	Pendant Bottom (Includes item 12)	9SM23063	1	X
8	UI to IO Link Harness	9SS30398	1	X
9	Pendant Estop Harness	9SS30399	1	X
10	Dual Rocker Switch PCB Harness	9SS30717	1	X
12	Pendant Input Harness Assembly, includes:	9SS30458	1	X
12A	Pendant Input Harness	NSS	1	X
12B	Screw	NSS	4	X
13	I/O PCB Assembly, includes:	9SS31339	1	X
13A	I/O PCB	NSS	1	X
13B	Screw	NSS	7	X
14	User Interface PCB Assembly, includes:	9SS31337	1	X
14A	User Interface PCB	NSS	1	X
14B	Screw	NSS	7	X
15	Pendant Hook Assembly, includes:	9SS29560-22	1	X
15A	Pendant Hook	NSS	1	X
15B	Rubber Bumper	NSS	1	X
15C	Screw	NSS	3	X
16	Pendant Strap Assembly, includes:	9SS29560-21	1	X
16A	Pendant Strap A	NSS	1	X
16B	Pendant Strap B	NSS	1	X
17	Pushbutton Operator	9SS29987	1	X
19	Button Cover Small	9SS23055-1	11	X
20	Knob	9SM22778-1	1	X
21	Spatter Shield Pocket Assembly, includes:	9SM23325	1	X
21A	Spatter Shield Pocket	NSS	1	X
21B	Screws	NSS	4	X
22	Optical Encoder	9SS32527	1	X

12-31-18

NOTE: This Parts Manual is provided as an informative guide only, when ordering parts always refer to the Lincoln Electric Parts List.

CUSTOMER ASSISTANCE POLICY

The business of The Lincoln Electric Company is manufacturing and selling high quality welding equipment, consumables, and cutting equipment. Our challenge is to meet the needs of our customers and to exceed their expectations. On occasion, purchasers may ask Lincoln Electric for advice or information about their use of our products. We respond to our customers based on the best information in our possession at that time. Lincoln Electric is not in a position to warrant or guarantee such advice, and assumes no liability, with respect to such information or advice. We expressly disclaim any warranty of any kind, including any warranty of fitness for any customer's particular purpose, with respect to such information or advice. As a matter of practical consideration, we also cannot assume any responsibility for updating or correcting any such information or advice once it has been given, nor does the provision of information or advice create, expand or alter any warranty with respect to the sale of our products.

Lincoln Electric is a responsive manufacturer, but the selection and use of specific products sold by Lincoln Electric is solely within the control of, and remains the sole responsibility of the customer. Many variables beyond the control of Lincoln Electric affect the results obtained in applying these types of fabrication methods and service requirements.

Subject to Change – This information is accurate to the best of our knowledge at the time of printing. Please refer to www.lincolnelectric.com for any updated information.



THE LINCOLN ELECTRIC COMPANY

22801 St. Clair Avenue • Cleveland, OH • 44117-1199 • U.S.A.
Phone: +1.216.481.8100 • www.lincolnelectric.com